



# STB7N52K3, STD7N52K3 STF7N52K3, STP7N52K3

N-channel 525 V, 0.72  $\Omega$ , 6 A SuperMESH3™ Power MOSFET  
in D<sup>2</sup>PAK, DPAK, TO-220FP and TO-220 packages

Datasheet — production data

## Features

Order codes	V <sub>DSS</sub>	R <sub>DS(on)</sub> max.	I <sub>D</sub>	P <sub>w</sub>
STB7N52K3	525 V	< 0.85 $\Omega$	6 A	90 W
STD7N52K3				90 W
STF7N52K3				25 W
STP7N52K3				90 W

- 100% avalanche tested
- Extremely high dv/dt capability
- Gate charge minimized
- Very low intrinsic capacitance
- Improved diode reverse recovery characteristics
- Zener-protected

## Application

- Switching applications

## Description

These SuperMESH3™ Power MOSFETs are the result of improvements applied to STMicroelectronics' SuperMESH™ technology, combined with a new optimized vertical structure. These devices boast an extremely low on-resistance, superior dynamic performance and high avalanche capability, rendering them suitable for the most demanding applications.

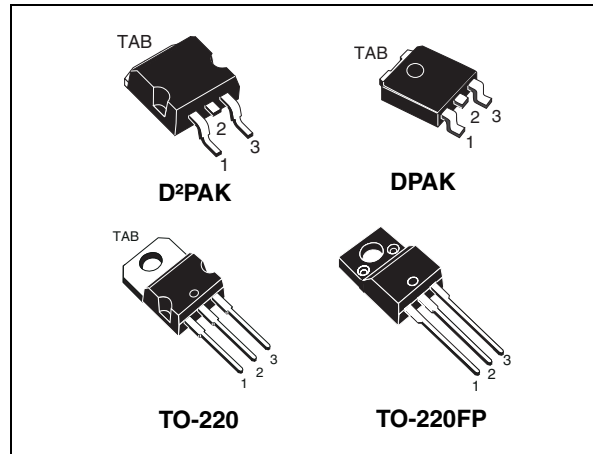

Figure 1. Internal schematic diagram

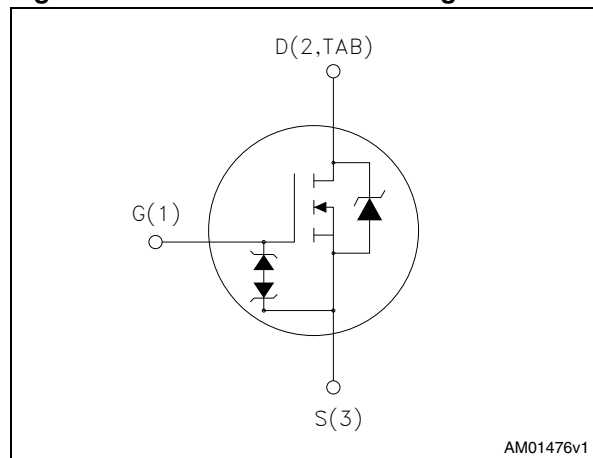

Table 1. Device summary

Order codes	Marking	Package	Packaging
STB7N52K3	7N52K3	D <sup>2</sup> PAK	Tape and reel
STD7N52K3		DPAK	
STF7N52K3		TO-220FP	Tube
STP7N52K3		TO-220	

# Contents

<b>1</b>	<b>Electrical ratings</b> .....	<b>3</b>
<b>2</b>	<b>Electrical characteristics</b> .....	<b>4</b>
	2.1 Electrical characteristics (curves) .....	6
<b>3</b>	<b>Test circuits</b> .....	<b>9</b>
<b>4</b>	<b>Package mechanical data</b> .....	<b>10</b>
<b>5</b>	<b>Package mechanical data</b> .....	<b>18</b>
<b>6</b>	<b>Revision history</b> .....	<b>21</b>

# 1 Electrical ratings

**Table 2. Absolute maximum ratings**

Symbol	Parameter	Value				Unit
		TO-220	DPAK	D <sup>2</sup> PAK	TO-220FP	
$V_{GS}$	Gate- source voltage	± 30				V
$I_D$	Drain current (continuous) at $T_C = 25\text{ °C}$	6		6 <sup>(1)</sup>		A
$I_D$	Drain current (continuous) at $T_C = 100\text{ °C}$	3.8		3.8 <sup>(1)</sup>		A
$I_{DM}^{(2)}$	Drain current (pulsed)	24		24 <sup>(1)</sup>		A
$P_{TOT}$	Total dissipation at $T_C = 25\text{ °C}$	90		25		W
$I_{AR}$	Avalanche current, repetitive or not-repetitive (pulse width limited by $T_j$ max)	3				A
$E_{AS}$	Single pulse avalanche energy (starting $T_j = 25\text{ °C}$ , $I_D = I_{AR}$ , $V_{DD} = 50V$ )	100				mJ
$V_{ESD(G-S)}$	Gate source ESD(HBM-C = 100 pF, R = 1.5 kΩ)	2500				V
$dv/dt^{(3)}$	Peak diode recovery voltage slope	12				V/ns
$V_{ISO}$	Insulation withstand voltage (RMS) from all three leads to external heat sink (t = 1 s; $T_C = 25\text{ °C}$ )	2500				V
$T_{stg}$	Storage temperature	- 55 to 150				°C
$T_j$	Max. operating junction temperature	150				°C

- Limited by package
- Pulse width limited by safe operating area
- $I_{SD} \leq 6\text{ A}$ ,  $di/dt = 400\text{ V}$ , peak  $V_{DS} < V_{(BR)DSS}$ ,  $V_{DD} = 80\% V_{(BR)DSS}$ .

**Table 3. Thermal data**

Symbol	Parameter	Value				Unit
		TO-220	DPAK	D <sup>2</sup> PAK	TO-220FP	
$R_{thj-case}$	Thermal resistance junction-case max	1.39			5	°C/W
$R_{thj-pcb}$	Thermal resistance junction-pcb max		50	30		°C/W
$R_{thj-amb}$	Thermal resistance junction-ambient max	62.5			62.5	°C/W
$T_l$	Maximum lead temperature for soldering purpose	300			300	°C

## 2 Electrical characteristics

( $T_C = 25\text{ °C}$  unless otherwise specified)

**Table 4. On /off states**

Symbol	Parameter	Test conditions	Min.	Typ.	Max.	Unit
$V_{(BR)DSS}$	Drain-source breakdown voltage	$I_D = 1\text{ mA}$ , $V_{GS} = 0$	525			V
$I_{DSS}$	Zero gate voltage drain current ( $V_{GS} = 0$ )	$V_{DS} = \text{Max rating}$ $V_{DS} = \text{Max rating}$ , $T_C = 125\text{ °C}$			1 50	$\mu\text{A}$ $\mu\text{A}$
$I_{GSS}$	Gate-body leakage current ( $V_{DS} = 0$ )	$V_{GS} = \pm 20\text{ V}$			$\pm 10$	$\mu\text{A}$
$V_{GS(th)}$	Gate threshold voltage	$V_{DS} = V_{GS}$ , $I_D = 50\text{ }\mu\text{A}$	3	3.75	4.5	V
$R_{DS(on)}$	Static drain-source on resistance	$V_{GS} = 10\text{ V}$ , $I_D = 3\text{ A}$		0.72	0.85	$\Omega$

**Table 5. Dynamic**

Symbol	Parameter	Test conditions	Min.	Typ.	Max.	Unit
$C_{iss}$ $C_{oss}$ $C_{rss}$	Input capacitance Output capacitance Reverse transfer capacitance	$V_{DS} = 100\text{ V}$ , $f = 1\text{ MHz}$ , $V_{GS} = 0$	-	870 70 13	-	pF pF pF
$C_{o(tr)}^{(1)}$	Equivalent capacitance time related	$V_{DS} = 0\text{ to }520\text{ V}$ , $V_{GS} = 0$	-	53	-	pF
$R_G$	Intrinsic gate resistance	$f = 1\text{ MHz}$ open drain	-	3.5	-	$\Omega$
$Q_g$ $Q_{gs}$ $Q_{gd}$	Total gate charge Gate-source charge Gate-drain charge	$V_{DD} = 420\text{ V}$ , $I_D = 6\text{ A}$ , $V_{GS} = 10\text{ V}$ (see <a href="#">Figure 20</a> )	-	33 6 21	-	nC nC nC

1.  $C_{oss,eq}$  time related is defined as a constant equivalent capacitance giving the same charging time as  $C_{oss}$  when  $V_{DS}$  increases from 0 to 80%  $V_{DSS}$

**Table 6. Switching times**

Symbol	Parameter	Test conditions	Min.	Typ.	Max	Unit	
$t_{d(on)}$	Turn-on delay time	$V_{DD} = 260\text{ V}$ , $I_D = 3\text{ A}$ , $R_G = 4.7\text{ }\Omega$ , $V_{GS} = 10\text{ V}$ (see <a href="#">Figure 19</a> )		13		ns	
$t_r$	Rise time		-	11	-	ns	
$t_{d(off)}$	Turn-off-delay time				36		ns
$t_f$	Fall time				19		ns

**Table 7. Source drain diode**

Symbol	Parameter	Test conditions	Min.	Typ.	Max.	Unit
$I_{SD}$	Source-drain current		-		6	A
$I_{SDM}^{(1)}$	Source-drain current (pulsed)		-		24	A
$V_{SD}^{(2)}$	Forward on voltage	$I_{SD} = 6 \text{ A}, V_{GS} = 0$	-		1.5	V
$t_{rr}$	Reverse recovery time	$I_{SD} = 6 \text{ A}, di/dt = 100 \text{ A}/\mu\text{s}$ $V_{DD} = 60 \text{ V}$ (see <a href="#">Figure 24</a> )	-	220		ns
$Q_{rr}$	Reverse recovery charge			1800		nC
$I_{RRM}$	Reverse recovery current			16		A
$t_{rr}$	Reverse recovery time	$I_{SD} = 6 \text{ A}, di/dt = 100 \text{ A}/\mu\text{s}$ $V_{DD} = 60 \text{ V}, T_j = 150 \text{ }^\circ\text{C}$ (see <a href="#">Figure 24</a> )	-	250		ns
$Q_{rr}$	Reverse recovery charge			2200		nC
$I_{RRM}$	Reverse recovery current			18		A

1. Pulse width limited by safe operating area
2. Pulsed: Pulse duration = 300  $\mu\text{s}$ , duty cycle 1.5%

**Table 8. Gate-source Zener diode**

Symbol	Parameter	Test conditions	Min.	Typ.	Max.	Unit
$BV_{GSO}^{(1)}$	Gate-source breakdown voltage	$I_{gs} = \pm 1 \text{ mA}$ (open drain)	30	-		V

1. The built-in back-to-back Zener diodes have specifically been designed to enhance not only the device's ESD capability, but also to make them safely absorb possible voltage transients that may occasionally be applied from gate to source. In this respect the Zener voltage is appropriate to achieve an efficient and cost-effective intervention to protect the device's integrity. These integrated Zener diodes thus avoid the usage of external components

## 2.1 Electrical characteristics (curves)

Figure 2. Safe operating area for TO-220, D<sup>2</sup>PAK

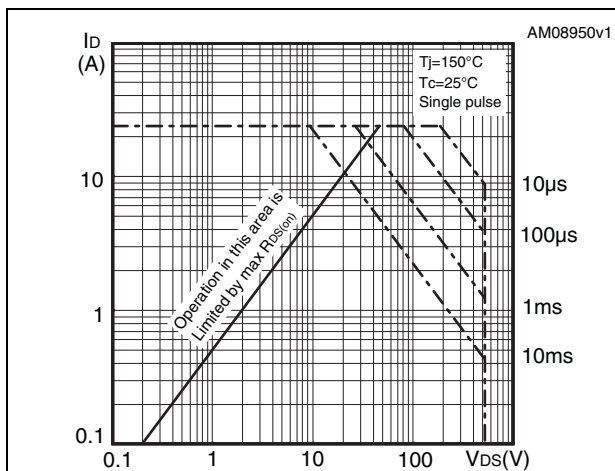

Figure 3. Thermal impedance for TO-220, D<sup>2</sup>PAK

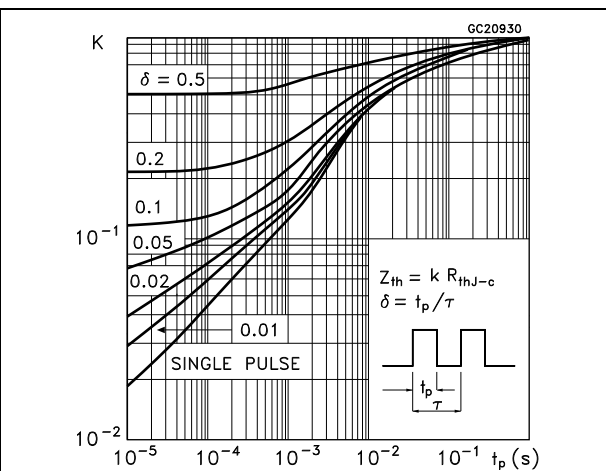

Figure 4. Safe operating area for DPAK

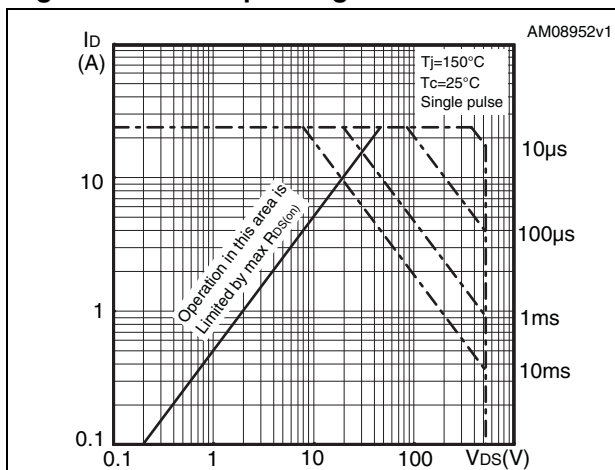

Figure 5. Thermal impedance for DPAK

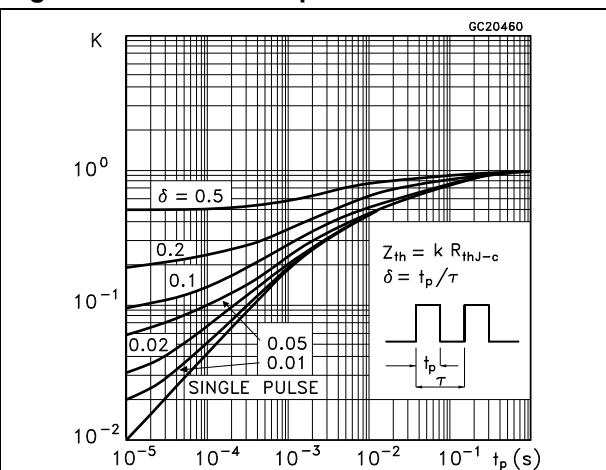

Figure 6. Safe operating area for TO-220FP

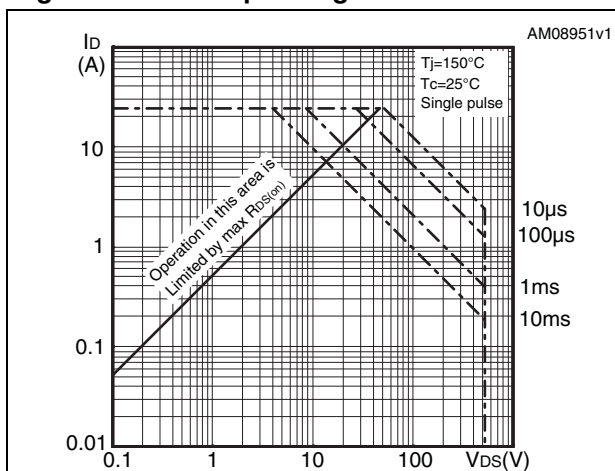

Figure 7. Thermal impedance for TO-220FP

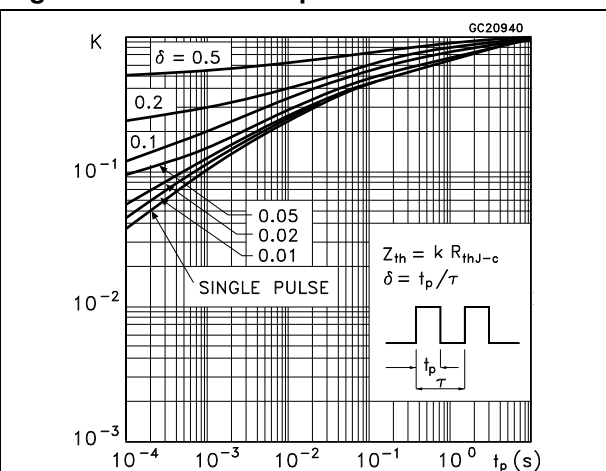

Figure 8. Output characteristics

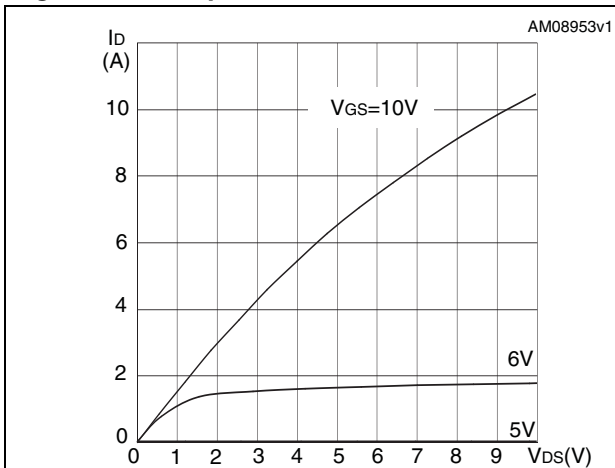

Figure 9. Transfer characteristics

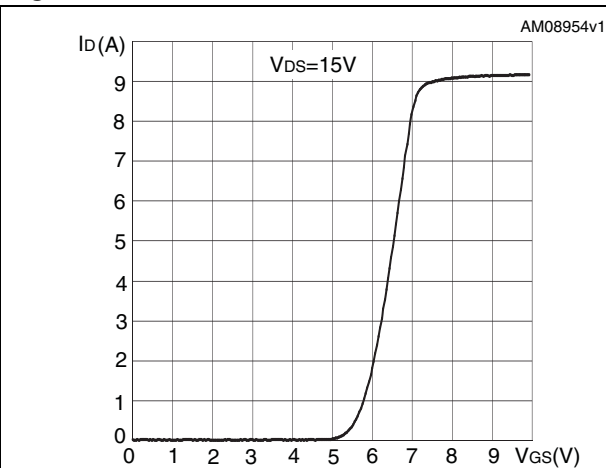

Figure 10. Normalized  $BV_{DSS}$  vs temperature

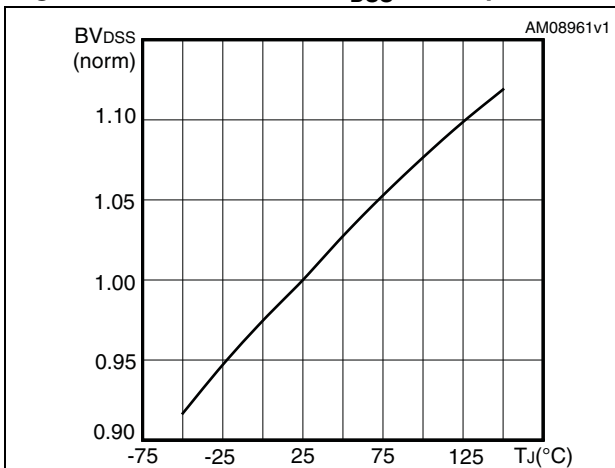

Figure 11. Static drain-source on resistance

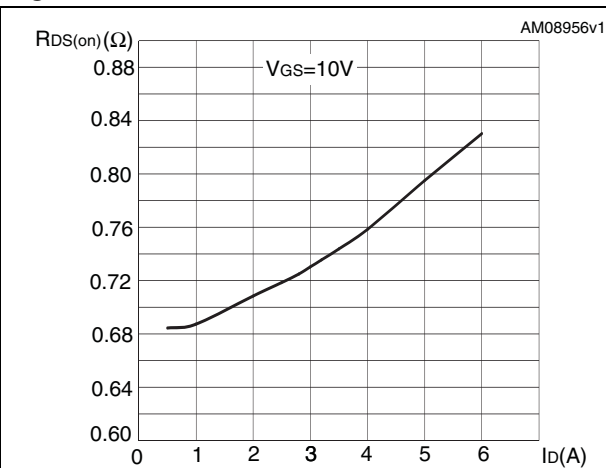

Figure 12. Output capacitance stored energy

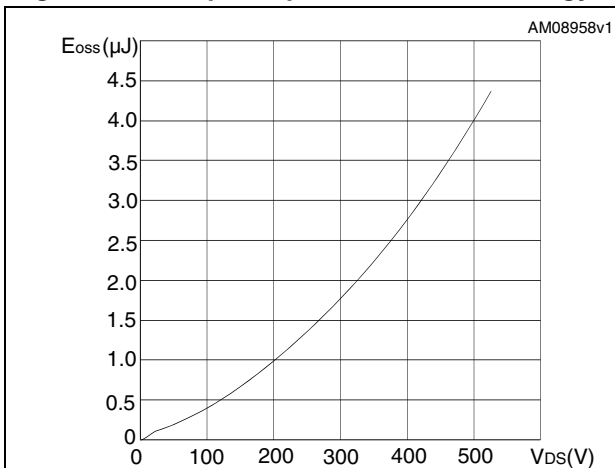

Figure 13. Capacitance variations

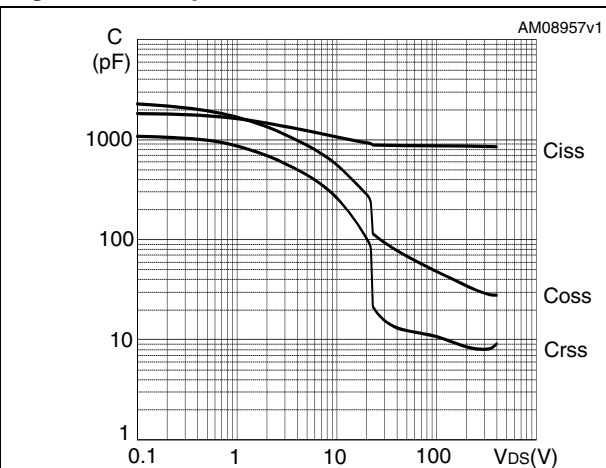

Figure 14. Gate charge vs gate-source voltage Figure 15. Normalized on resistance vs temperature

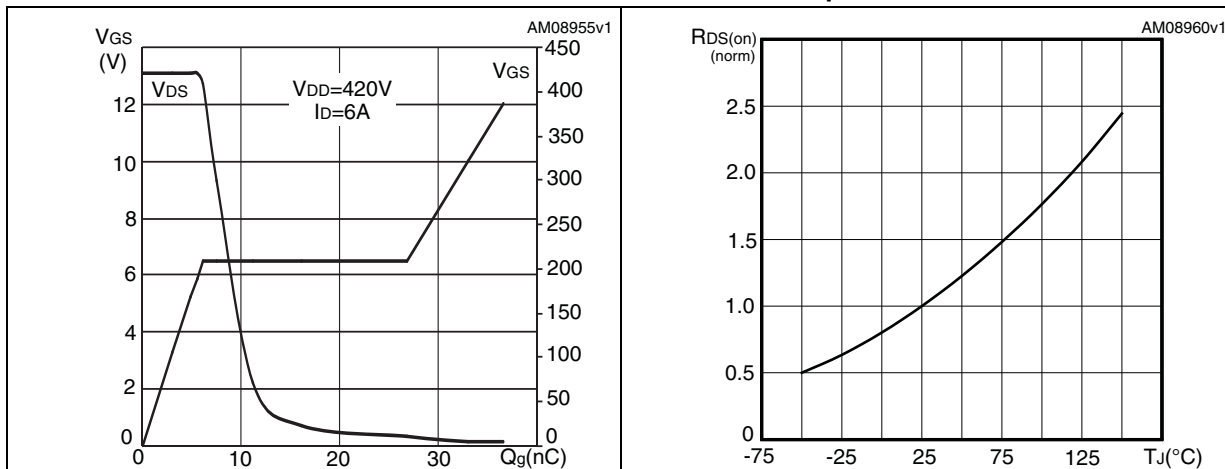

Figure 16. Normalized gate threshold voltage vs temperature Figure 17. Maximum avalanche energy vs temperature

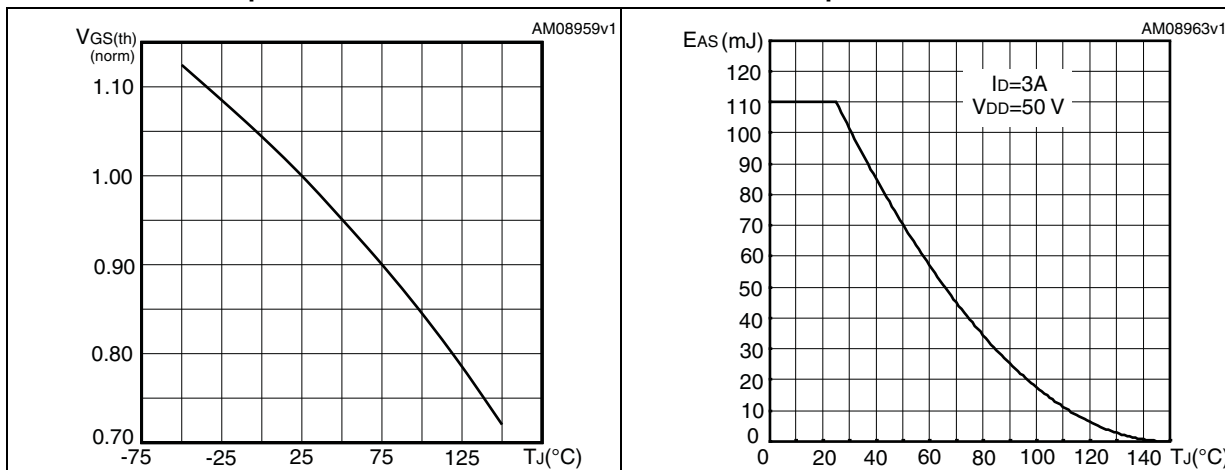
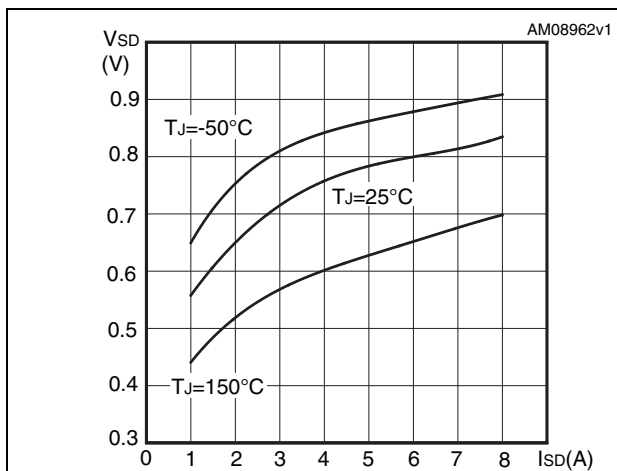

Figure 18. Source-drain diode forward characteristics





### 3 Test circuits

**Figure 19. Switching times test circuit for resistive load**



AM01468v1

**Figure 20. Gate charge test circuit**



AM01469v1

**Figure 21. Test circuit for inductive load switching and diode recovery times**



AM01470v1

**Figure 22. Unclamped Inductive load test circuit**



AM01471v1

**Figure 23. Unclamped inductive waveform**



AM01472v1

**Figure 24. Switching time waveform**



AM01473v1

## 4 Package mechanical data

In order to meet environmental requirements, ST offers these devices in different grades of ECOPACK® packages, depending on their level of environmental compliance. ECOPACK® specifications, grade definitions and product status are available at: [www.st.com](http://www.st.com). ECOPACK is an ST trademark.

**Table 9. D<sup>2</sup>PAK (TO-263) mechanical data**

Dim.	mm		
	Min.	Typ.	Max.
A	4.40		4.60
A1	0.03		0.23
b	0.70		0.93
b2	1.14		1.70
c	0.45		0.60
c2	1.23		1.36
D	8.95		9.35
D1	7.50		
E	10		10.40
E1	8.50		
e		2.54	
e1	4.88		5.28
H	15		15.85
J1	2.49		2.69
L	2.29		2.79
L1	1.27		1.40
L2	1.30		1.75
R		0.4	
V2	0°		8°

Figure 25. D<sup>2</sup>PAK (TO-263) drawing



Figure 26. D<sup>2</sup>PAK footprint<sup>(a)</sup>



a. All dimension are in millimeters

Table 10. DPAK (TO-252) mechanical data

Dim.	mm		
	Min.	Typ.	Max.
A	2.20		2.40
A1	0.90		1.10
A2	0.03		0.23
b	0.64		0.90
b4	5.20		5.40
c	0.45		0.60
c2	0.48		0.60
D	6.00		6.20
D1		5.10	
E	6.40		6.60
E1		4.70	
e		2.28	
e1	4.40		4.60
H	9.35		10.10
L	1		1.50
L1		2.80	
L2		0.80	
L4	0.60		1
R		0.20	
V2	0°		8°

Figure 27. DPAK (TO-252) drawing

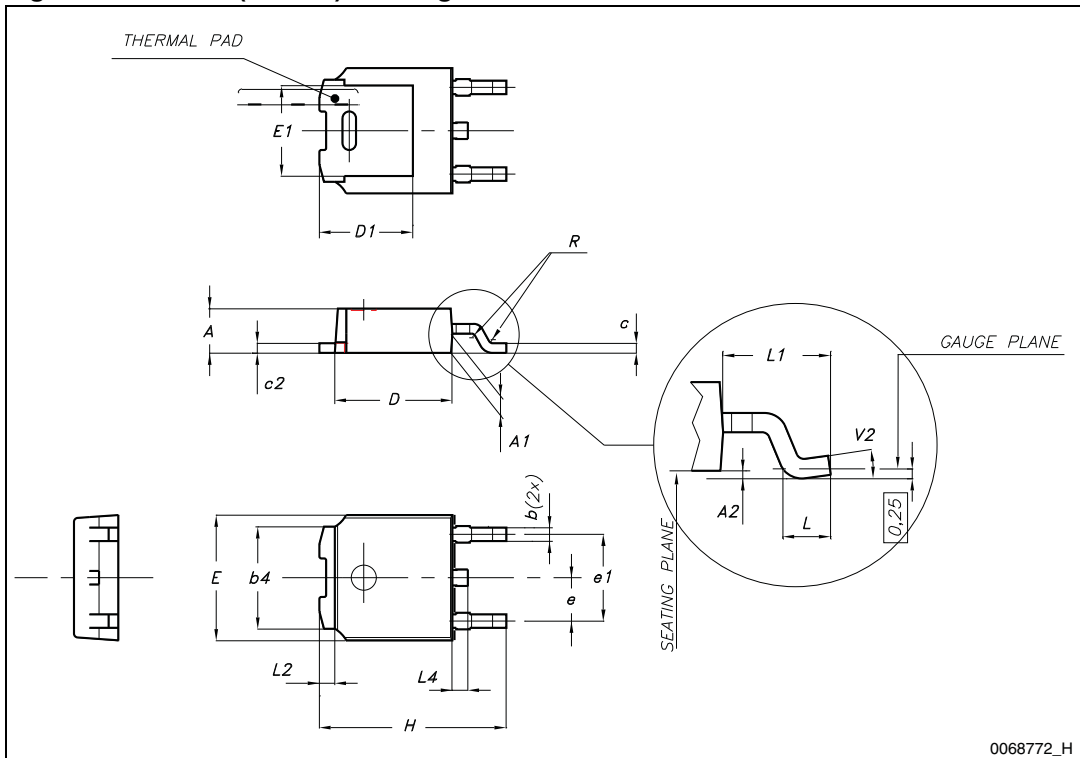
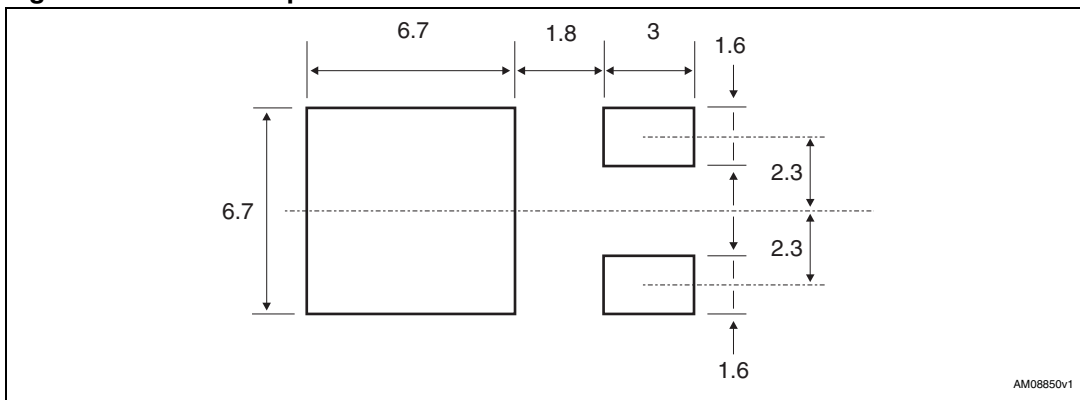

Figure 28. DPAK footprint<sup>(b)</sup>



b. All dimension are in millimeters

Table 11. TO-220FP mechanical data

Dim.	mm		
	Min.	Typ.	Max.
A	4.4		4.6
B	2.5		2.7
D	2.5		2.75
E	0.45		0.7
F	0.75		1
F1	1.15		1.70
F2	1.15		1.70
G	4.95		5.2
G1	2.4		2.7
H	10		10.4
L2		16	
L3	28.6		30.6
L4	9.8		10.6
L5	2.9		3.6
L6	15.9		16.4
L7	9		9.3
Dia	3		3.2

Figure 29. TO-220FP drawing

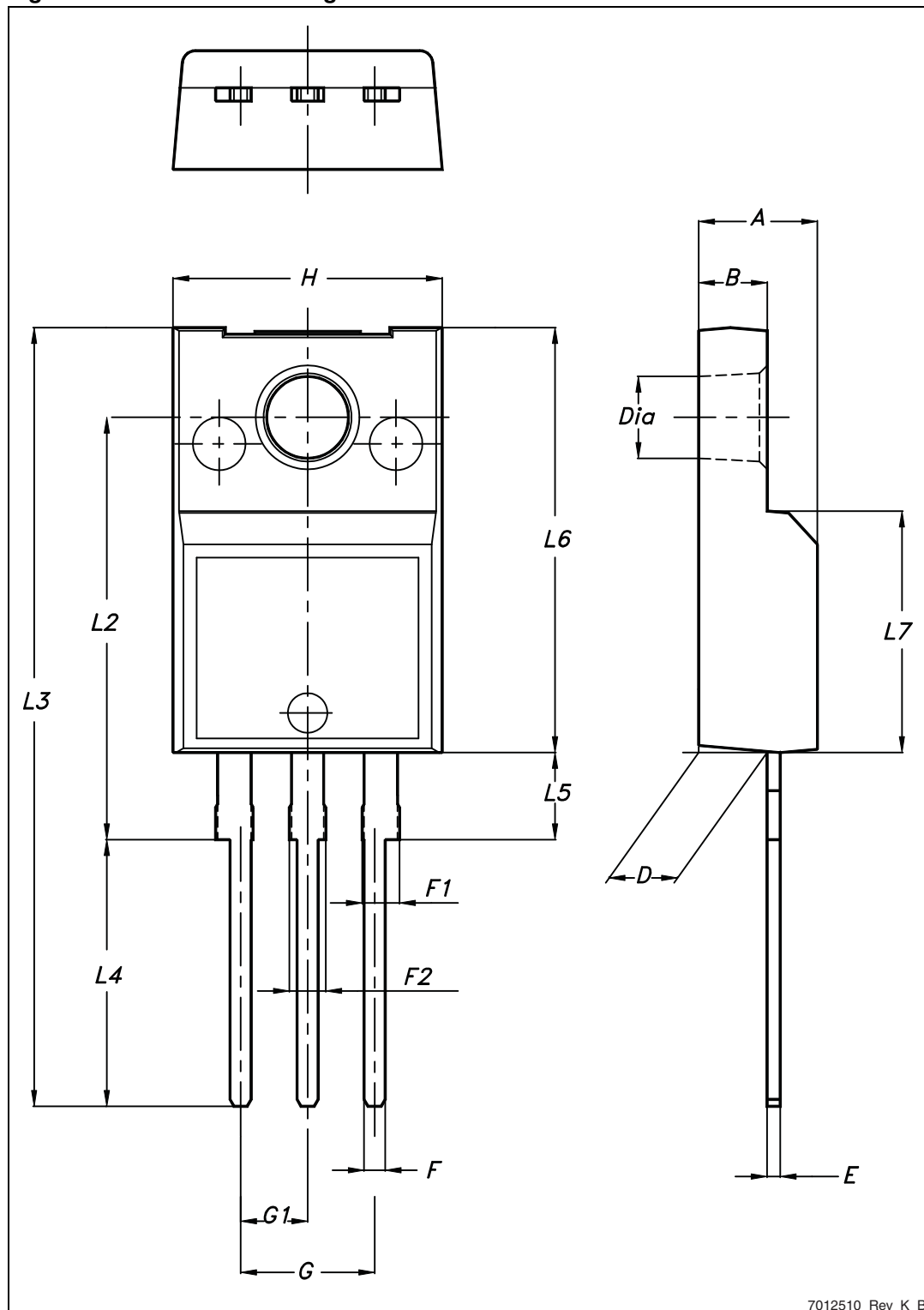

7012510\_Rev\_K\_B

Table 12. TO-220 type A mechanical data

Dim.	mm		
	Min.	Typ.	Max.
A	4.40		4.60
b	0.61		0.88
b1	1.14		1.70
c	0.48		0.70
D	15.25		15.75
D1		1.27	
E	10		10.40
e	2.40		2.70
e1	4.95		5.15
F	1.23		1.32
H1	6.20		6.60
J1	2.40		2.72
L	13		14
L1	3.50		3.93
L20		16.40	
L30		28.90	
ØP	3.75		3.85
Q	2.65		2.95



Figure 30. TO-220 type A drawing

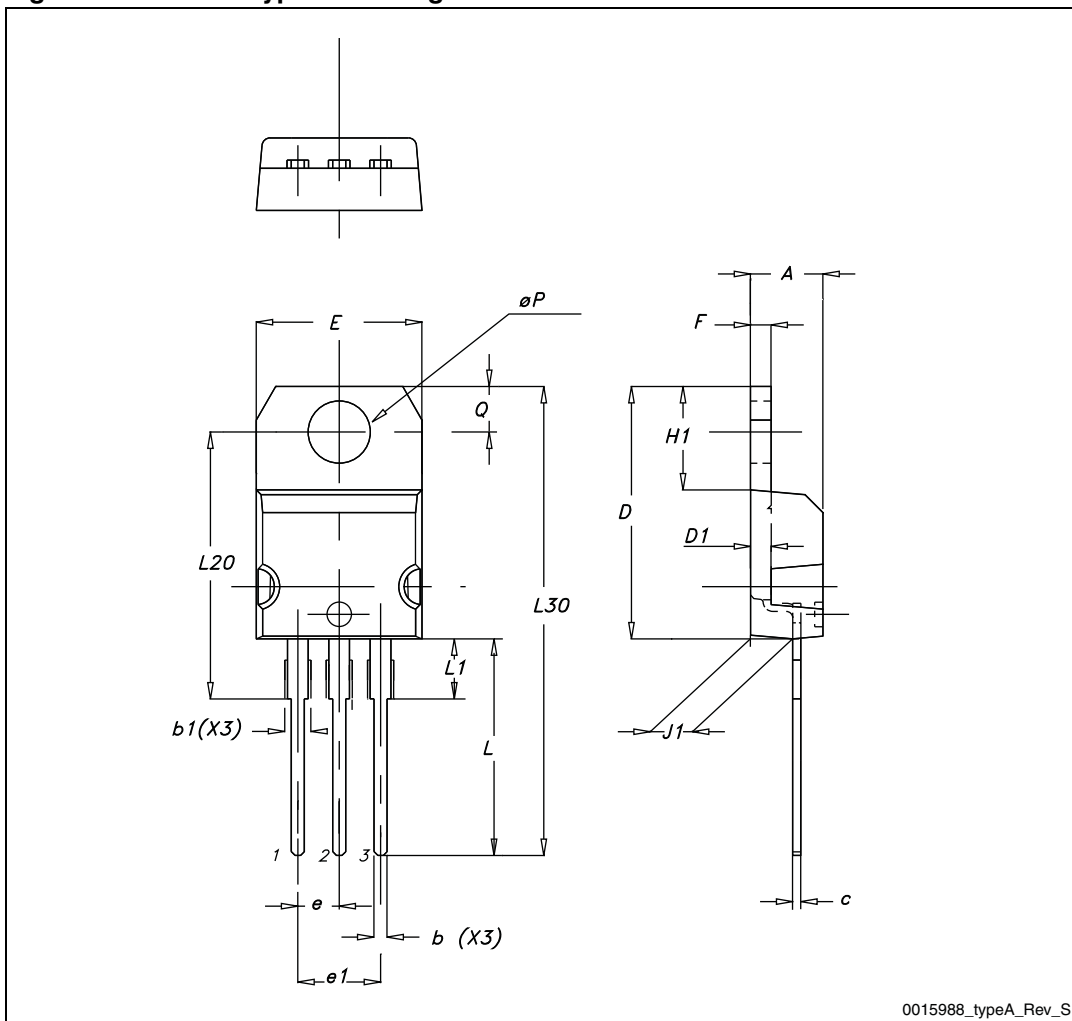

## 5 Package mechanical data

**Table 13. D<sup>2</sup>PAK (TO-263) tape and reel mechanical data**

Tape			Reel		
Dim.	mm		Dim.	mm	
	Min.	Max.		Min.	Max.
A0	10.5	10.7	A		330
B0	15.7	15.9	B	1.5	
D	1.5	1.6	C	12.8	13.2
D1	1.59	1.61	D	20.2	
E	1.65	1.85	G	24.4	26.4
F	11.4	11.6	N	100	
K0	4.8	5.0	T		30.4
P0	3.9	4.1			
P1	11.9	12.1	Base qty		1000
P2	1.9	2.1	Bulk qty		1000
R	50				
T	0.25	0.35			
W	23.7	24.3			

**Table 14. DPAK (TO-252) tape and reel mechanical data**

Tape			Reel		
Dim.	mm		Dim.	mm	
	Min.	Max.		Min.	Max.
A0	6.8	7	A		330
B0	10.4	10.6	B	1.5	
B1		12.1	C	12.8	13.2
D	1.5	1.6	D	20.2	
D1	1.5		G	16.4	18.4
E	1.65	1.85	N	50	
F	7.4	7.6	T		22.4
K0	2.55	2.75			
P0	3.9	4.1	Base qty.		2500
P1	7.9	8.1	Bulk qty.		2500

Table 14. DPAK (TO-252) tape and reel mechanical data (continued)

Tape			Reel		
Dim.	mm		Dim.	mm	
	Min.	Max.		Min.	Max.
P2	1.9	2.1			
R	40				
T	0.25	0.35			
W	15.7	16.3			

Figure 31. Tape for DPAK (TO-252) and D<sup>2</sup>PAK (TO-263)

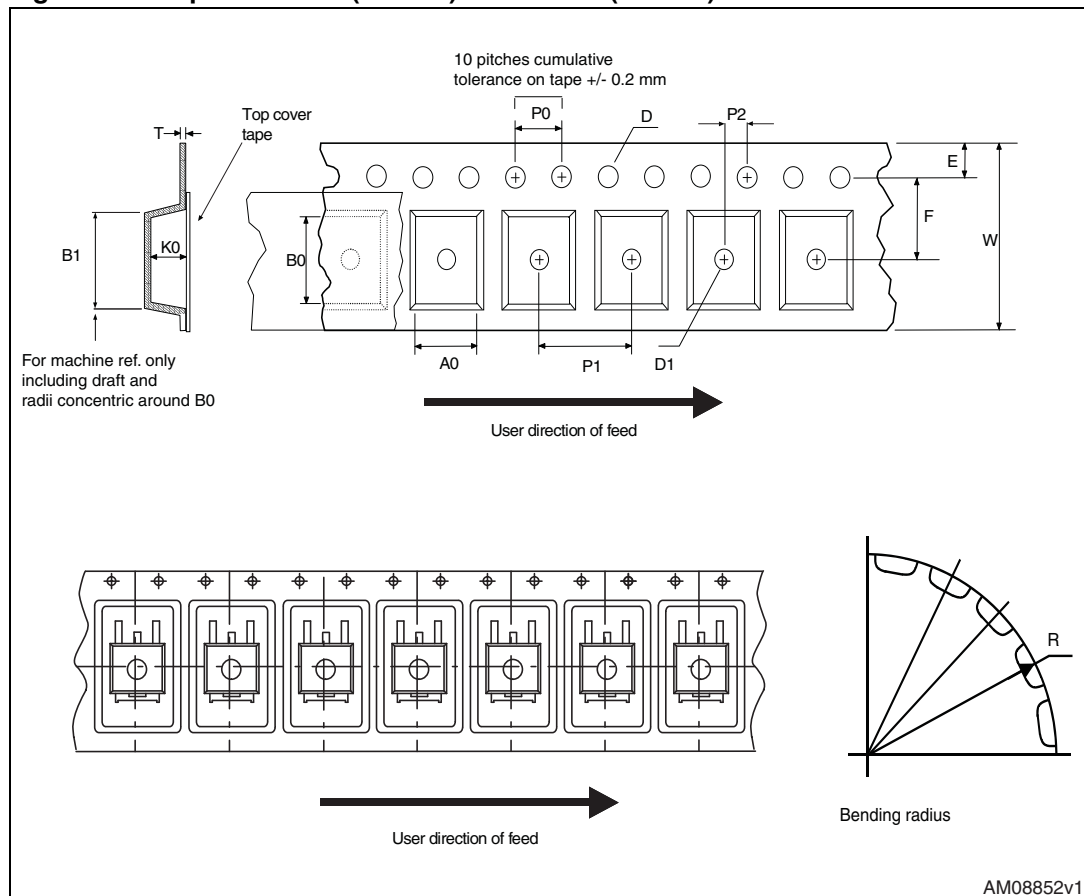
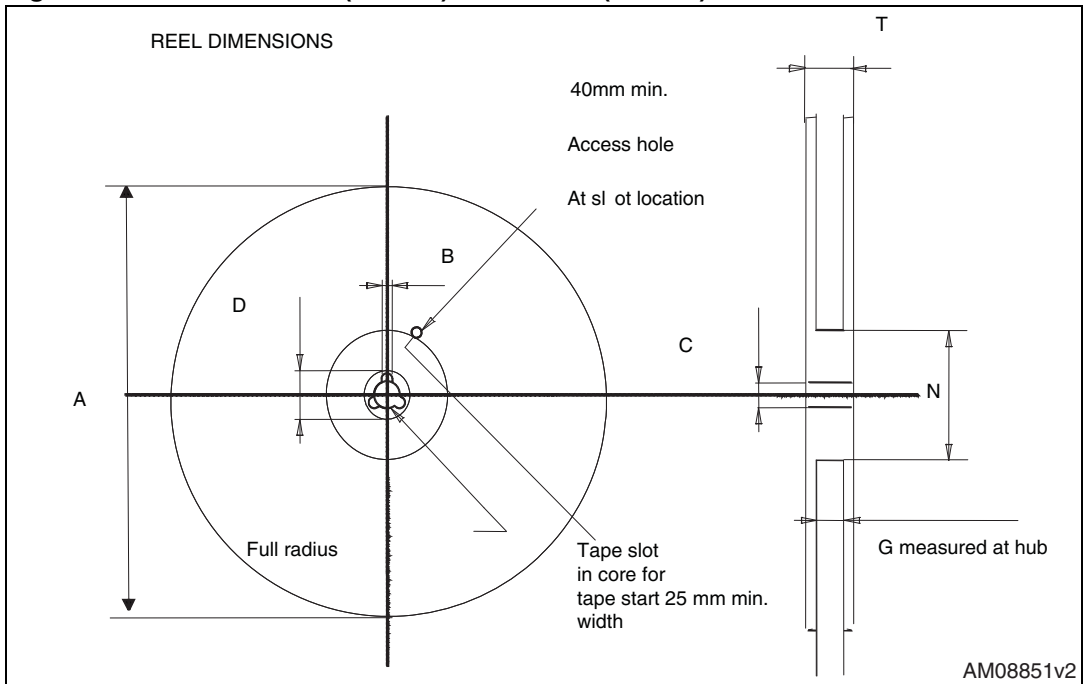

Figure 32. Reel for DPAK (TO-252) and D<sup>2</sup>PAK (TO-263)



## 6 Revision history

Table 15. Document revision history

Date	Revision	Changes
07-Jul-2008	1	First release.
10-Sep-2009	2	Document status promoted from preliminary data to datasheet.
27-Jun-2011	3	<a href="#">Section 2.1: Electrical characteristics (curves)</a> has been updated.
07-Mar-2012	4	Updated <a href="#">Section 4: Package mechanical data</a> . Minor text changes.

**Please Read Carefully:**

Information in this document is provided solely in connection with ST products. STMicroelectronics NV and its subsidiaries ("ST") reserve the right to make changes, corrections, modifications or improvements, to this document, and the products and services described herein at any time, without notice.

All ST products are sold pursuant to ST's terms and conditions of sale.

Purchasers are solely responsible for the choice, selection and use of the ST products and services described herein, and ST assumes no liability whatsoever relating to the choice, selection or use of the ST products and services described herein.

No license, express or implied, by estoppel or otherwise, to any intellectual property rights is granted under this document. If any part of this document refers to any third party products or services it shall not be deemed a license grant by ST for the use of such third party products or services, or any intellectual property contained therein or considered as a warranty covering the use in any manner whatsoever of such third party products or services or any intellectual property contained therein.

**UNLESS OTHERWISE SET FORTH IN ST'S TERMS AND CONDITIONS OF SALE ST DISCLAIMS ANY EXPRESS OR IMPLIED WARRANTY WITH RESPECT TO THE USE AND/OR SALE OF ST PRODUCTS INCLUDING WITHOUT LIMITATION IMPLIED WARRANTIES OF MERCHANTABILITY, FITNESS FOR A PARTICULAR PURPOSE (AND THEIR EQUIVALENTS UNDER THE LAWS OF ANY JURISDICTION), OR INFRINGEMENT OF ANY PATENT, COPYRIGHT OR OTHER INTELLECTUAL PROPERTY RIGHT.**

**UNLESS EXPRESSLY APPROVED IN WRITING BY TWO AUTHORIZED ST REPRESENTATIVES, ST PRODUCTS ARE NOT RECOMMENDED, AUTHORIZED OR WARRANTED FOR USE IN MILITARY, AIR CRAFT, SPACE, LIFE SAVING, OR LIFE SUSTAINING APPLICATIONS, NOR IN PRODUCTS OR SYSTEMS WHERE FAILURE OR MALFUNCTION MAY RESULT IN PERSONAL INJURY, DEATH, OR SEVERE PROPERTY OR ENVIRONMENTAL DAMAGE. ST PRODUCTS WHICH ARE NOT SPECIFIED AS "AUTOMOTIVE GRADE" MAY ONLY BE USED IN AUTOMOTIVE APPLICATIONS AT USER'S OWN RISK.**

Resale of ST products with provisions different from the statements and/or technical features set forth in this document shall immediately void any warranty granted by ST for the ST product or service described herein and shall not create or extend in any manner whatsoever, any liability of ST.

ST and the ST logo are trademarks or registered trademarks of ST in various countries.

Information in this document supersedes and replaces all information previously supplied.

The ST logo is a registered trademark of STMicroelectronics. All other names are the property of their respective owners.

© 2012 STMicroelectronics - All rights reserved

STMicroelectronics group of companies

Australia - Belgium - Brazil - Canada - China - Czech Republic - Finland - France - Germany - Hong Kong - India - Israel - Italy - Japan - Malaysia - Malta - Morocco - Philippines - Singapore - Spain - Sweden - Switzerland - United Kingdom - United States of America

[www.st.com](http://www.st.com)