

Hi-Reliability RAD Capable Optoisolator

HCC1000 / HCC1001



Features:

- TID Capable to 100Krad (SI)/cm² ELDRS (0.1rad/s)
- Neutron capable to 1E12 neutrons (14MeV)
- TX & TXV Processing available to MIL-STD-19500
- 1 KV electrical Isolation
- Base Contact provided for conventional transistor biasing

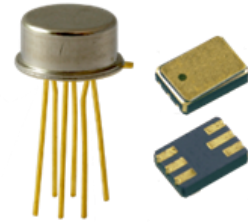

Description:

These devices are similar to Optek's 4N series of opto isolators with exception of the die. TX & TXV processing is per MIL-PRF-19500 and can be modified per customer SCDs. Each device consists of a IRLED & NPN transistor mounted in either hermetic TO-78 metal can, 6 pin SMD or custom packaging.

Applications:

Circuit electrical isolation in space applications such as satellites, launchers, space vehicles and planetary rovers

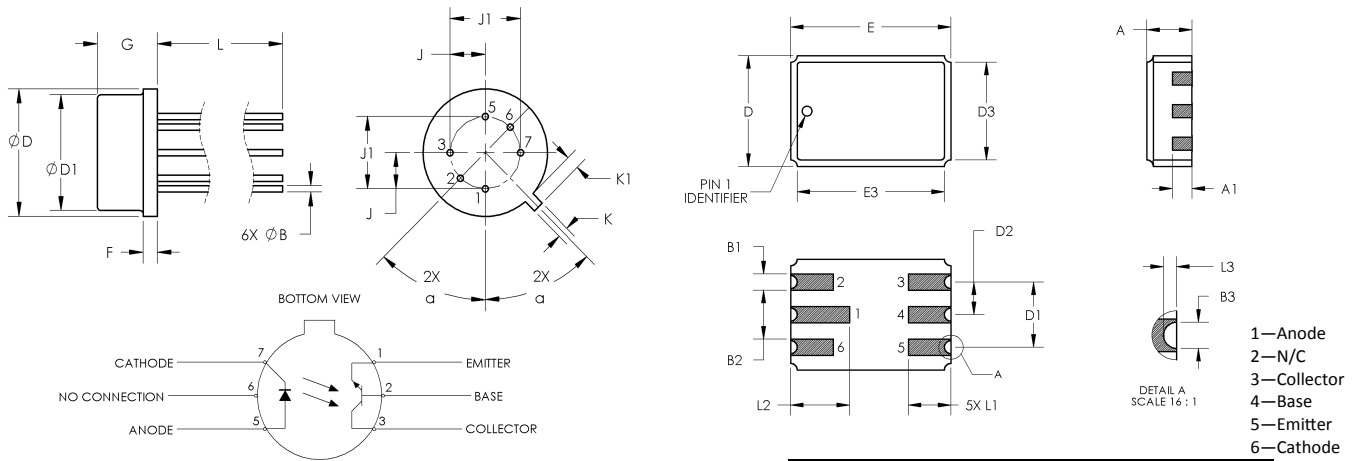

(COLLECTOR MAY OR MAY NOT BE CONNECTED INTERNALLY TO CASE)

LTR	DIMENSIONS			
	INCHES		MILLIMETERS	
	MIN	MAX	MIN	MAX
∅D	0.335	0.370	8.51	9.40
∅D1	0.305	0.335	7.75	8.51
∅B	0.016	0.019	0.41	0.48
a	45° T.P.		45° T.P.	
F		0.040		1.02
G	0.155	0.185	3.94	4.70
J	.100 T.P.		2.54 T.P.	
J1	.200 T.P.		5.08 T.P.	
K	0.028	0.034	0.71	0.86
K1	0.029	0.045	0.74	1.14
L	0.500	0.600	12.70	15.24

LTR	DIMENSIONS			
	INCHES		MILLIMETERS	
	MIN	MAX	MIN	MAX
A	0.066	0.080	1.68	2.03
A1	0.026	0.034	0.66	0.86
B1	0.022	0.028	0.56	0.71
B2	.072 REF		1.83 REF	
B3	0.006	0.022	0.15	0.56
D	0.165	0.175	4.19	4.44
D1	0.095	0.105	2.41	2.67
D2	0.045	0.055	1.14	1.39
D3		0.175		4.44
E	0.240	0.250	6.10	6.35
E3		0.250		6.35
L1	0.060	0.070	1.65	1.78
L2	0.082	0.098	2.08	2.49
L3	0.003		0.08	

General Note

TT Electronics reserves the right to make changes in product specification without notice or liability. All information is subject to TT Electronics' own data and is considered accurate at time of going to print.

TT Electronics | OPTEK Technology, Inc.
1645 Wallace Drive, Carrollton, TX 75006 | Ph: +1 972 323 2200
www.ttelectronics.com | www.optekinc.com

Electrical Specifications

Absolute Maximum Ratings ($T_A = 25^\circ\text{C}$ unless otherwise noted)

Storage Temperature Range	-55° C to +150° C
Operating Temperature Range	-55° C to +150° C
Input-to-Output Isolation Voltage	$\pm 1.00\text{ kVDC}^{(1)}$
Lead Soldering Temperature (TO-78 Metal Can) [1/16 inch (1.6 mm) from case for 5 seconds with soldering iron]	260° C ⁽²⁾
Soldering Temperature (SMD) Vapor Phase Reflow for 30 seconds	215° C

Input Diode (LED)

Forward DC Current (65° C or below)	40 mA
Reverse Voltage	2 V
Power Dissipation	60 mW ⁽³⁾

Output Phototransistor:

Continuous Collector Current	50 mA
Collector-Emitter Voltage	40 V
Collector-Base Voltage	45 V
Emitter-Base Voltage	7.0 V
Power Dissipation	300 mW ⁽⁴⁾

Notes:

1. Measured with input leads shorted together and output leads shorted together.
2. RMA flux is recommended.
3. Derate linearly 1.0 mW/° C above 65° C.
4. Derate linearly 3.0 mW/° C above 25° C.

General Note

TT Electronics reserves the right to make changes in product specification without notice or liability. All information is subject to TT Electronics' own data and is considered accurate at time of going to print.

TT Electronics | OPTEK Technology, Inc.
1645 Wallace Drive, Carrollton, TX 75006 | Ph: +1 972 323 2200
www.ttelectronics.com | www.optekinc.com

Performance

Electrical Characteristics (T_A = 25°C unless otherwise noted)

SYMBOL	PARAMETER	MIN	TYP	MAX	UNITS	TEST CONDITIONS
--------	-----------	-----	-----	-----	-------	-----------------

Input Diode

V _F	Forward Voltage	0.80 1.00 0.70	- - -	1.70 1.9 1.50	V	I _F = 10.0 mA I _F = 10.0 mA, T _A = -55° C I _F = 10.0 mA, T _A = 125° C
I _R	Reverse Current	-	-	100	μA	V _R = 2.0 V

Output Phototransistor

V _{(BR)CEO}	Collector-Emitter Breakdown Voltage	40	-	-	V	I _C = 1.0 mA, I _B = 0, I _F = 0
V _{(BR)CBO}	Collector-Base Breakdown Voltage	45	-	-	V	I _C = 100 μA, I _B = 0, I _F = 0
V _{(BR)EBO}	Emitter-Base Breakdown Voltage	7	-	-	V	I _E = 100 μA, I _C = 0, I _F = 0
I _{C(OFF)} ¹	Collector-Emitter Dark Current	-	-	100	nA	V _{CE} = 20 V, I _B = 0, I _F = 0
I _{C(OFF)} ²	Collector-Emitter Dark Current	-	-	100	μA	V _{CE} = 20 V, I _B = 0, I _F = 0, T _A = 100° C
I _{CB(OFF)}	Collector-Base Dark Current	-	-	10	nA	V _{CB} = 20 V, I _E = 0, I _F = 0

Coupled

I _{C(ON)}	On-State Collector Current	1 15 10 15	- - - -	- - - -	mA	I _F = 1.0 mA, V _{CE} = 1.0 V, I _B = 0 I _F = 15.0 mA, V _{CE} = 1.0 V, I _B = 0 I _F = 10.0 mA, V _{CE} = 5.0 V, I _B = 0 I _F = 15.0 mA, V _{CE} = 5.0 V, I _B = 0
		2.8 2.0	- -	- -		I _F = 2.0 mA, V _{CE} = 5.0 V, I _B = 0, T _A = -55° C I _F = 2.0 mA, V _{CE} = 5.0 V, I _B = 0, T _A = 100° C
I _{CB(ON)}	On-State Collector Base	30	-	-	μA	V _{CB} = 5 V, I _E = 0, I _F = 10 mA
V _{CE(SAT)}	Collector-Emitter Saturation Voltage	-	-	0.30	V	I _F = 20.0 mA, I _C = 10.0 mA, I _B = 0
H _{FE}	DC Current Gain	100	-	-	V	V _{CE} = 5.0 V, I _C = 10.0 mA, I _F = 0 mA
R _{IO}	Resistance (Input-to-Output)	10 ¹¹	-	-	Ω	V _{I-O} = ± 1000 VDC ⁽¹⁾
C _{IO}	Capacitance (Input-to-Output)	-	-	5	pF	V _{I-O} = 0 V, f = 1.0 MHz ⁽¹⁾
T _R , T _F	Rise and Fall Time	-	-	20	μs	V _{CC} = 10.0 V, I _F = 10.0 mA, R _L = 100 Ω

Notes:

1. Measured with input leads shorted together and output leads shorted together.

General Note

TT Electronics reserves the right to make changes in product specification without notice or liability. All information is subject to TT Electronics' own data and is considered accurate at time of going to print.

TT Electronics | OPTEK Technology, Inc.
1645 Wallace Drive, Carrollton, TX 75006 | Ph: +1 972 323 2200
www.ttelectronics.com | www.optekinc.com

Radiation Test Standards:

- **Total Ionizing Dose:** MIL-STD-883 Method 1019.7 and ASTM F1892-06 (0.1rad (si)/s) dose rate
- **Neutron:** MIL-STD-883 Method 1017.2 and ASTM Designation: E 772—94
- **Full Radiation report available**

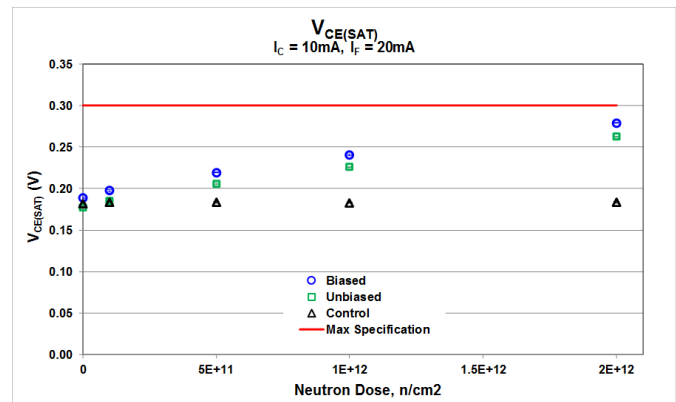
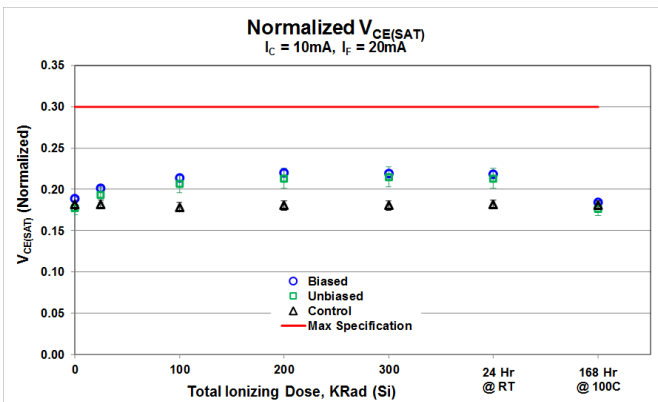
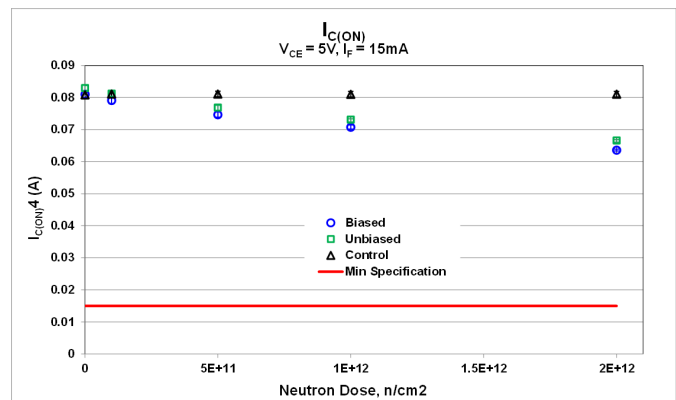
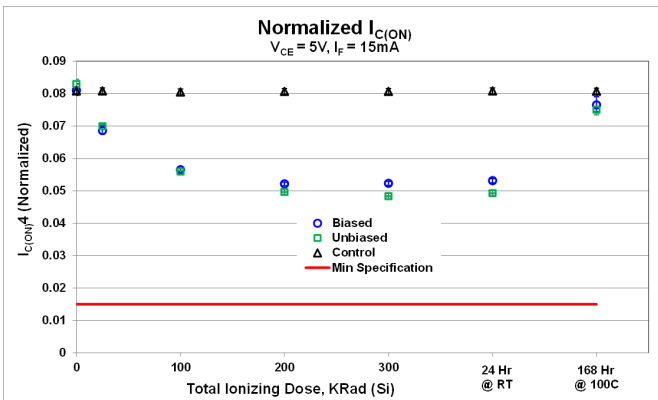
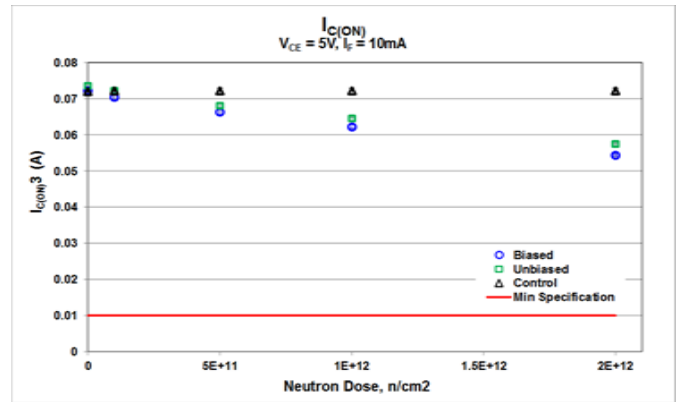
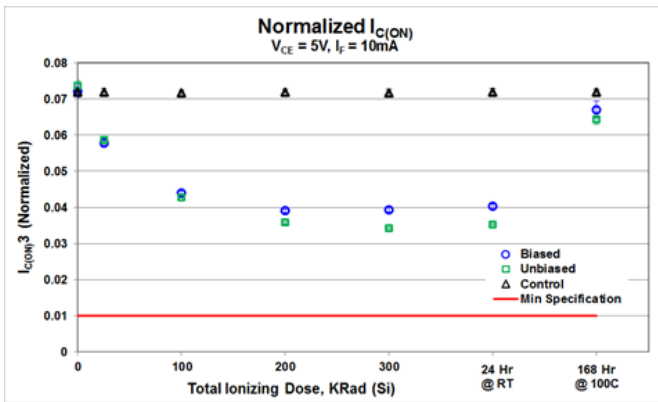

General Note
 TT Electronics reserves the right to make changes in product specification without notice or liability. All information is subject to TT Electronics' own data and is considered accurate at time of going to print.

TT Electronics | OPTEK Technology, Inc.
 1645 Wallace Drive, Carrollton, TX 75006 | Ph: +1 972 323 2200
www.ttelectronics.com | www.optekinc.com

Packaging

Package styles available:

Radiation testing was in a TO-78 can; functional & radiation samples can be supplied in discrete pairs such as, “pills” or TO-46 / TO-18 metal cans, 4 & 6 pin Hermetic Ceramic LLC, high voltage assemblies like the OPI120 and OPI150 hermetic high voltage isolators and more.

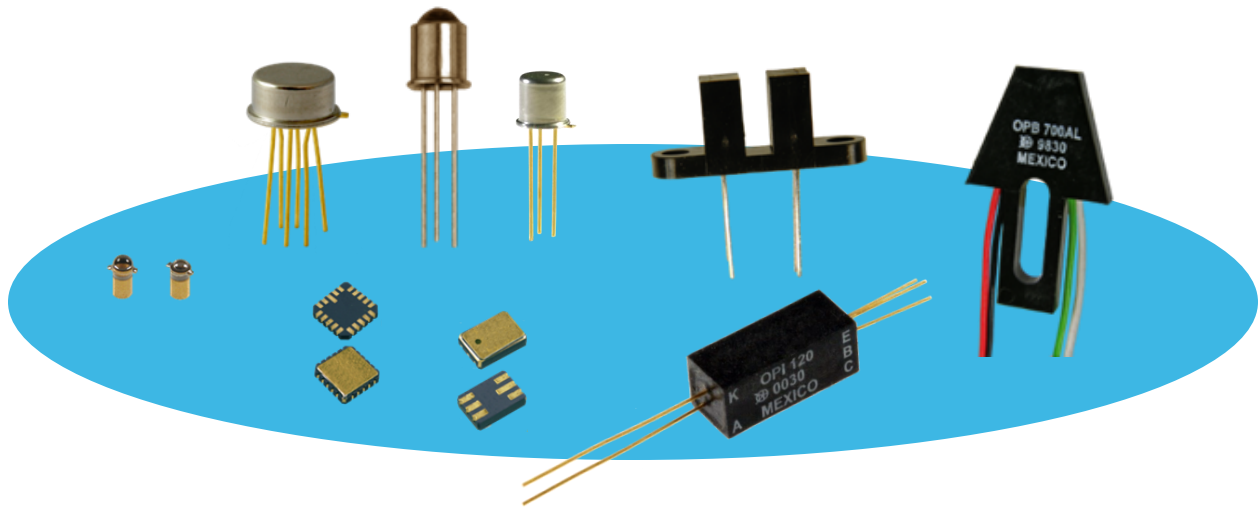

General Note

TT Electronics reserves the right to make changes in product specification without notice or liability. All information is subject to TT Electronics' own data and is considered accurate at time of going to print.

TT Electronics | OPTEK Technology, Inc.
1645 Wallace Drive, Carrollton, TX 75006 | Ph: +1 972 323 2200
www.ttelectronics.com | www.optekinc.com

