

Panasonic
ideas for life

HOUR METER

TH13·TH23

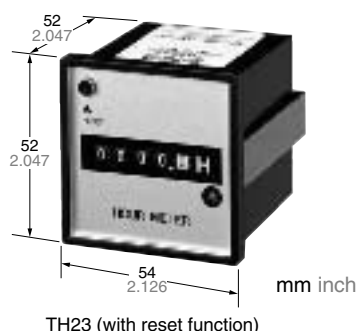

Replacing the TH13/23 series unit with the TH14/24 series unit

The TH13/TH23 series units are interchangeable with the TH14/24 series units. Use the specified mounting frame because of a different setup method. It is advisable to introduce the TH14/23 series units for the first time.

DIN48 size and mounting frame setup



Mounting frame (sold separately): TH1400020

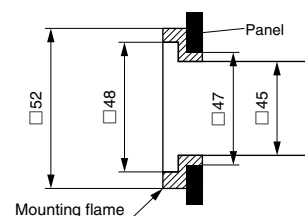

FEATURES

- 1. High-performance compact sync motor**
The accurately turning motor is employed to provide for longer period of measurement.
- 2. Compact and stylish**
- 3. Easier wiring**
The flat terminals (#187) are quick and easy to connect.
- 4. Rotary indicator**
The rotary indicator makes one turn every 2 minutes for quick monitoring.

5. CE marking

The hour meters satisfy EMC directives (EN50081-2/EN50082-2) and low-voltage directives (EN61010-1).

TYPICAL APPLICATIONS

Maintenance management of machine tools, automated machines, control panels, forming machines, medical equipment, generators, compressors, water treatment facilities, presses, motors, etc.

SPECIFICATIONS

Rated operating voltage	100V, 200V, 110V, 115 to 120V, 220V, 240V	
Operating voltage range	85 to 115% of rated operating voltage	
Rated frequency	50 Hz, 60 Hz (other model)	
Counting range	0 to 99999.9 hours (TH13 series) 0 to 9999.9 hours (TH23 series)	
Minimum time display	0.1 hours (6 min)	
Rated power consumption	Approx. 1.5 W	
Initial insulation resistance (At 500 V DC)	Min. 100 MΩ Between live and dead metal parts	
Initial breakdown voltage	2,000 Vrms Between live and dead metal parts	
Max. temperature rise	55°C 131°F	
Vibration resistance	Functional	10 to 55 Hz: 1 cycle/min double amplitude of 0.5 mm (10 min on 3 axes)
Shock resistance	Functional	Min. 98 m/s ² {10 G} (4 times on 3 axes)
	Destructive	Min. 980 m/s ² {100 G} (5 times on 3 axes)
Ambient temperature	-10 to +50°C +14 to 122°F	
Ambient humidity	Max. 85% RH	
Weight	135 g 4.76 oz	130 g 4.59 oz

PRODUCT TYPE

Type	Rated operating voltage	Part No.		Rated operating voltage	Part No.	
		50Hz	60Hz		50Hz	60Hz
TH13 types (without reset)	100V AC	TH1345	TH1346	24V AC	TH1325	TH1326
		TH1355	TH1356	115V AC (115 to 120V AC)	TH1375	TH1376
	200V AC	TH1365	TH1366	220V AC	TH1385	TH1386
	110V AC			240V AC	TH1395	TH1396
TH23 types (with reset)	100V AC	TH2345	TH2346	24V AC	TH2325	TH2326
		TH2355	TH2356	115V AC (115 to 120V AC)	TH2375	TH2376
	200V AC	TH2365	TH2366	220V AC	TH2385	TH2386
	110V AC			240V AC	TH2395	TH2396

- Notes: 1. The AC 115-120V, AC 220V and AC 240V types are UL-recognized and CSA-certified. For those products, specify "U" at the end of the part No. when ordering.
2. If you want the CE marking on your products, specify "CE" at the end of the part No. when ordering.
3. When ordering a UL-listed/CSA-certified, CE-marked product, specify "TH2376UCE" for example (in the case of TH13 series AC 115-120V, 60Hz type).

TH13·TH23

DIMENSIONS

General tolerance: $\pm 1.0 \pm .039$ mm inch

• TH13

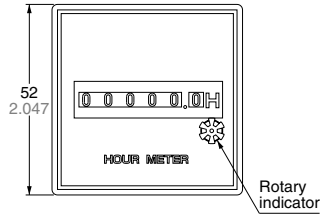

• TH23

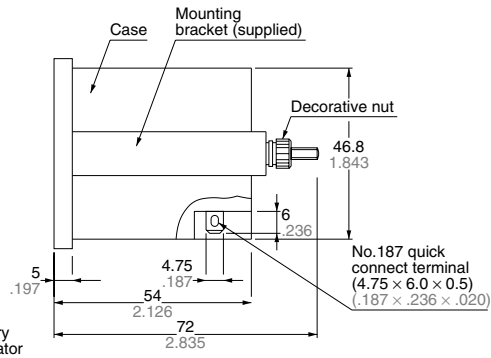
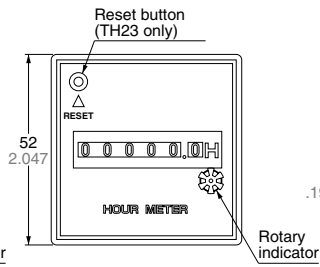

WIRING DIAGRAM

Panel mounting

• Panel cutout

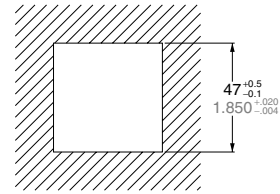
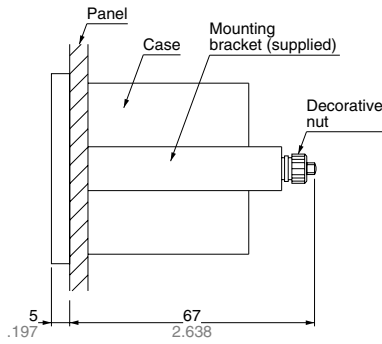
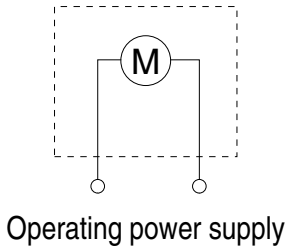

Panasonic
ideas for life

DIN48 SIZE HOUR METER

TH14·TH24

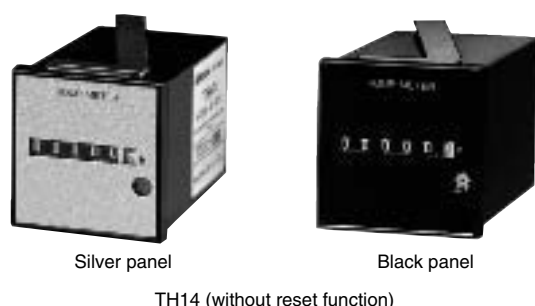
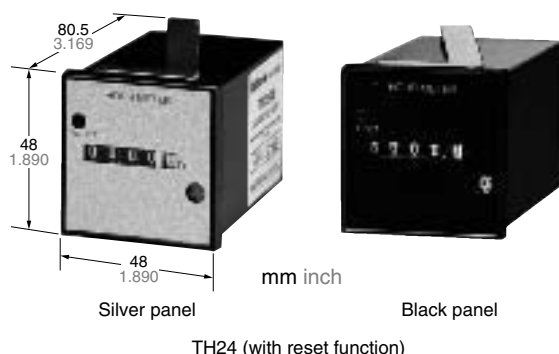

FEATURES

1. High-performance compact sync motor

The accurately turning motor is employed to provide for longer period of measurement.

2. Common for 50/60 Hz power frequency

A lever is used to select 50 Hz or 60 Hz. There is no need to rearrange the control panel and other signal destinations.

3. Dimensions as per DIN 43700 standard

The units are in the 48 × 48 DIN standard size. They can be fitted in panels and give refined metallic appearance.

4. Easier wiring

The flat terminals (#187) are quick and easy to connect.

5. Rotary indicator

The rotary indicator makes one turn every 2 minutes for quick monitoring.

6. CE marking

The hour meters satisfy EMC directives (EN50081-2/EN50082-2) and low-voltage directives (EN61010-1).

TYPICAL APPLICATIONS

Maintenance management of machine tools, automated machines, control panels, forming machines, medical equipment, generators, compressors, water treatment facilities, presses, motors, etc.

SPECIFICATIONS

Rated operating voltage	12 V AC, 24 V AC, 48 V AC, 100 V AC, 110 V AC, 115 to 120 V AC, 200 V AC, 220 V AC, 240 V AC	
Operating voltage range	85 to 115% of rated operating voltage	
Rated frequency	50/60 Hz (selectable by switch)	
Counting range	0 to 99999.9 hours (TH14 series) 0 to 9999.9 hours (TH24 series)	
Minimum time display	0.1 hours (6 min)	
Rated power consumption	Approx. 1.5 W	
Initial insulation resistance (At 500 V DC)	Min. 100 MΩ; Between live and dead metal parts	
Initial breakdown voltage	2,000 Vrms Between live and dead metal parts	
Max. temperature rise	55°C 131°F	
Vibration resistance	Functional	10 to 55 Hz: 1 cycle/min double amplitude of 0.5 mm (10 min on 3 axes)
Shock resistance	Functional	Min 98 m/s ² {10 G} (4 times on 3 axes)
	Destructive	Min 980 m/s ² {100 G} (5 times on 3 axes)
Ambient temperature	-10 to +50°C +14 to +122°F	
Ambient humidity	Max. 85% RH	
Weight	145 g 5.11 oz (TH14 series)	150 g 5.29 oz (TH24 series)

PRODUCT TYPE

Type	Rated operating voltage	Part No.		Rated operating voltage	Part No.		Rated operating voltage	Part No.	
		Silver panel	Black panel		Silver panel	Black panel		Silver panel	Black panel
TH14 types (without reset)	100V AC	TH141S	TH141	24V AC	TH144S	TH144	115 to 120V AC	TH147S	TH147
	200V AC	TH142S	TH142	48V AC	TH145S	TH145	220V AC	TH148S	TH148
	12V AC	TH143S	TH143	110V AC	TH146S	TH146	240V AC	TH149S	TH149
TH24 types (with reset)	100V AC	TH241S	TH241	24V AC	TH244S	TH244	115 to 120V AC	TH247S	TH247
	200V AC	TH242S	TH242	48V AC	TH245S	TH245	220V AC	TH248S	TH248
	12V AC	TH243S	TH243	110V AC	TH246S	TH246	240V AC	TH249S	TH249

Notes: 1. Only the black-panel type is UL-recognized and CSA-certified. For this type, specify "U" at the end of the part No. when ordering.

2. If you want the CE marking on your products, specify "CE" at the end of the part No. when ordering.

3. When ordering a UL-listed/CSA-certified, CE-marked product, specify "TH147UCE" for example (in the case of TH14 series, AC 115-120V type).

DIMENSIONS

General tolerance: $\pm 1.0 \pm .039$ mm inch

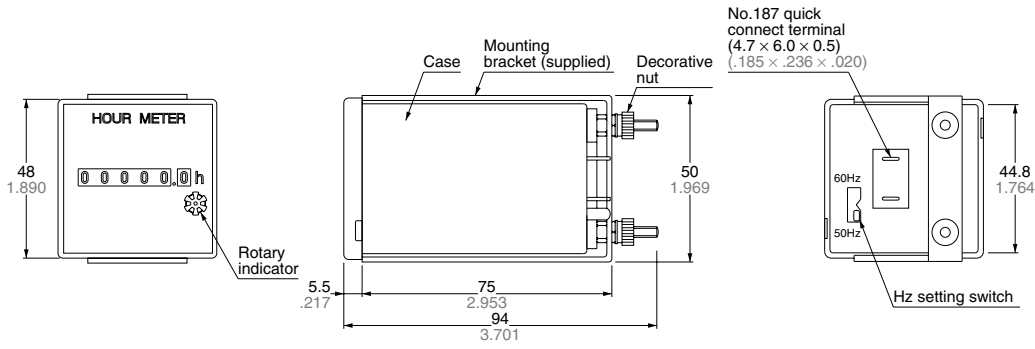

WIRING DIAGRAM

Panel mounting

mm inch

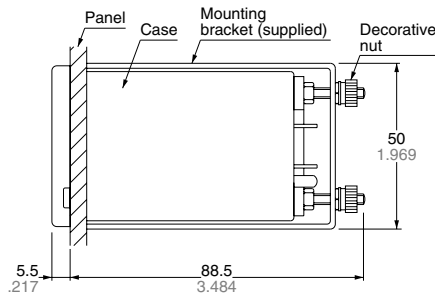
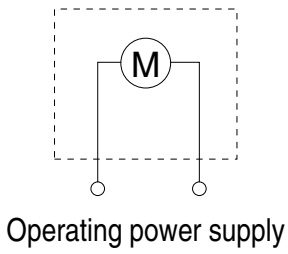

• Panel cutout

