

DC charging cable - EV-T1L2CC-DC125A-25,0FT1ASBK01 - 1628114

Please be informed that the data shown in this PDF Document is generated from our Online Catalog. Please find the complete data in the user's documentation. Our General Terms of Use for Downloads are valid (<http://phoenixcontact.com/download>)



DC charging cable with vehicle connector, open cable end, CCS type 1, Combined Charging System, SAE J1772, IEC 62196-3, 125 A / 600 V (DC), design line Standard, cable: 25 ft, black, straight, NOTE: Cable management may be required., mating face: black, handle area: gray

Product Description

DC charging cable with Vehicle Connector and open cable end for fast charging of electric vehicles (EV) with direct current (DC) via CCS type 1 Vehicle Inlets, for installation at charging stations for E-Mobility (EVSE)

Why buy this product

- Consistent design of all Phoenix Contact Vehicle Connectors and Infrastructure Plugs
- Silver-plated surface of the power and signal contacts
- Certified in accordance with IATF 16949:2016 and ISO 9001:2015
- Convenient handling, thanks to the ergonomic handle and additional, rubber grip components
- Integrated temperature sensors for monitoring the temperature at the power contacts



Key Commercial Data

Packing unit	1 STK
GTIN	
GTIN	4055626388649

Technical data

Product definition

Product type	DC charging cable with vehicle connector, open cable end
Standards/regulations	SAE J1772
	IEC 62196-3
Charging standard	CCS type 1
	Combined Charging System
Charging mode	Mode 4
Note	NOTE: Cable management may be required.
	Cable management is required in certain regions if the cable length exceeds 5.0 m (Switzerland) or 7.5 m (USA) (IEC 61851-1).

DC charging cable - EV-T1L2CC-DC125A-25,0FT1ASBK01 - 1628114

Technical data

Dimensions

Vehicle connector width	67.90 mm
Vehicle connector height	140.80 mm
Vehicle connector depth	260.00 mm
Conductor length	25 ft
Stripping length	130 mm ±20 mm

Ambient conditions

Ambient temperature (operation)	-30 °C ... 50 °C
Ambient temperature (storage/transport)	-40 °C ... 80 °C
Max. altitude	5000 m (above sea level)
	3R

Electrical properties

Maximum charging power	75 kW
Number of power contacts	3 (PE, DC+, DC-)
Rated current of power contacts	125 A
Rated voltage for power contacts	600 V DC
Number of signal contacts	2 (CP, CS)
Rated current for signal contacts	2 A
Rated voltage for signal contacts	30 V AC
Type of signal transmission	Pulse width modulation with modulated Powerline communication according to ISO/IEC 15118 / DIN SPEC 70121
Resistor coding	480 Ω (Lever actuated)
	150 Ω (Lever not actuated)
Temperature monitoring	2x Pt 1000

Mechanical properties

Insertion/withdrawal cycles	> 10000
Insertion force	< 75 N
Withdrawal force	< 75 N

Design

Design line	Standard
Housing color	black
Mating face color	black
Color handle area	gray
Actuating element color	gray
Color protective cap	black
Label	14.1 mm x 44.8 mm (customer logo on request)

Material

Housing material	Plastic
Material handle area	Soft plastic
Actuating lever material	Metal

DC charging cable - EV-T1L2CC-DC125A-25,0FT1ASBK01 - 1628114

Technical data

Material

Material mating face	Plastic
Flammability rating	V0
Material surface of contacts	Ag

Cable

Cable structure	2 x 1 AWG + 1 x 3 AWG + 3 x 2 x 18 AWG
Wiring standards/regulations	UL 62
	FFSO7.E343212
External cable diameter	35.3 mm ±0.5 mm
Type of conductor	straight
Outer sheath, material	TPE
External sheath, color	black
Minimum bending radius	529.5 mm (15 x diameter)

Temperature sensors

Type of sensor	Pt 1000
Standards/regulations	DIN EN 60751
Recommended measured current	1 mA (1 V at 0°C)
Tolerance at the sensor with the recommended measured current	±1K
Temperature range	-50 °C ... 130 °C
Temperature coefficient (TCR)	3850 ppm/K
Long-term stability (max. R0-Drift)	0.06 % (After 1000 hours at 130°C)
Shutdown temperature	90 °C equivalent to a Pt 1000 value of 1346.5 Ω

Environmental Product Compliance

REACH SVHC	Lead 7439-92-1
China RoHS	Environmentally Friendly Use Period = 10;
	For details about hazardous substances go to tab "Downloads", Category "Manufacturer's declaration"

Drawings

DC charging cable - EV-T1L2CC-DC125A-25,0FT1ASBK01 - 1628114

Connection diagram

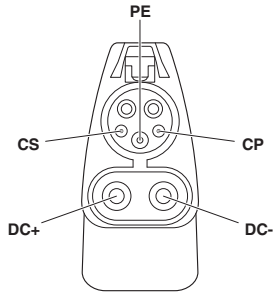

Schematic diagram

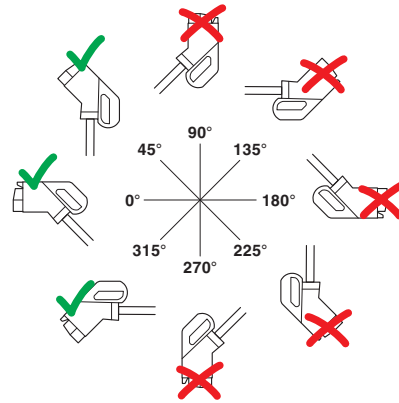

Pin assignment of the Vehicle Connector

The resting position must be installed in the charging station such that the user cannot hang up the vehicle connector upside down (90° to 270°). However, positions rotated upward (45°) or downward (315°) are options for a resting position.

Dimensional drawing

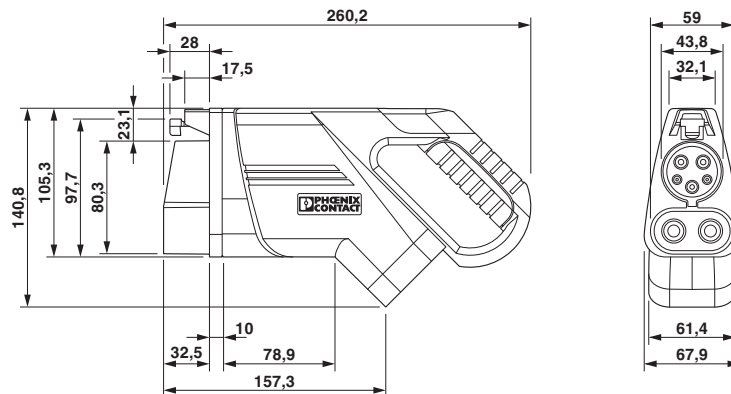

Ensure that the vehicle connector is placed in an appropriate resting position that ensures a minimum protection rating of IP24 in accordance with IEC 61851-1 for the entire time between charging. Use the dimensions of the vehicle connector to create this type of resting position. Detailed specifications can also be found in the download area.

DC charging cable - EV-T1L2CC-DC125A-25,0FT1ASBK01 - 1628114

Schematic diagram

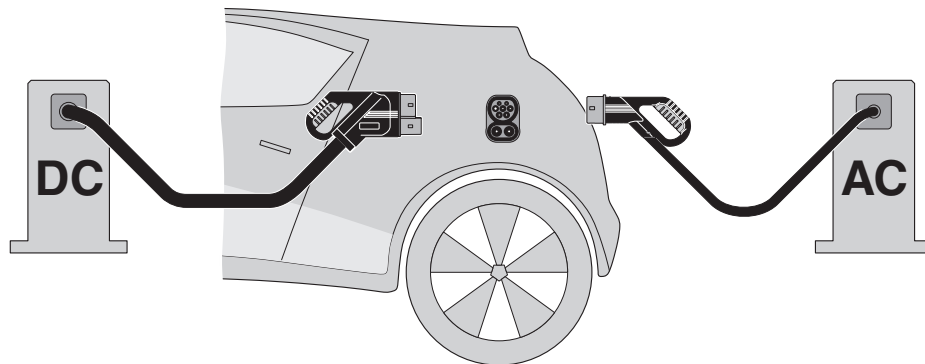

"Combined Charging System" principle

DC charging cable - EV-T1L2CC-DC125A-25,0FT1ASBK01 - 1628114

Schematic diagram

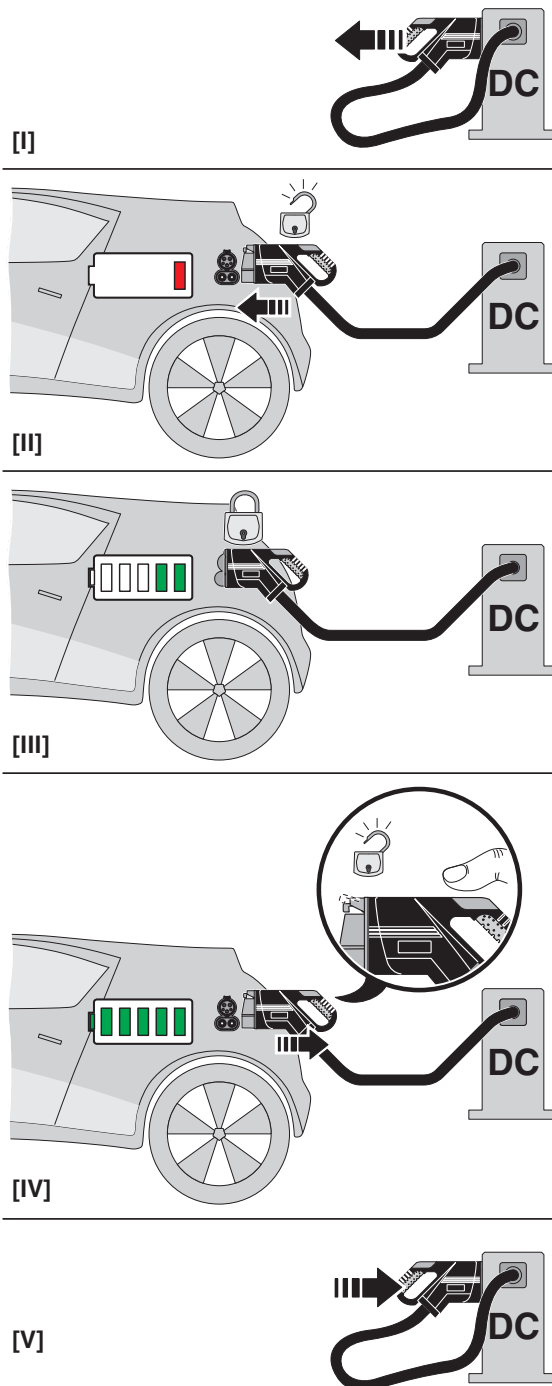

DC charging cable - EV-T1L2CC-DC125A-25,0FT1ASBK01 - 1628114

Schematic diagram

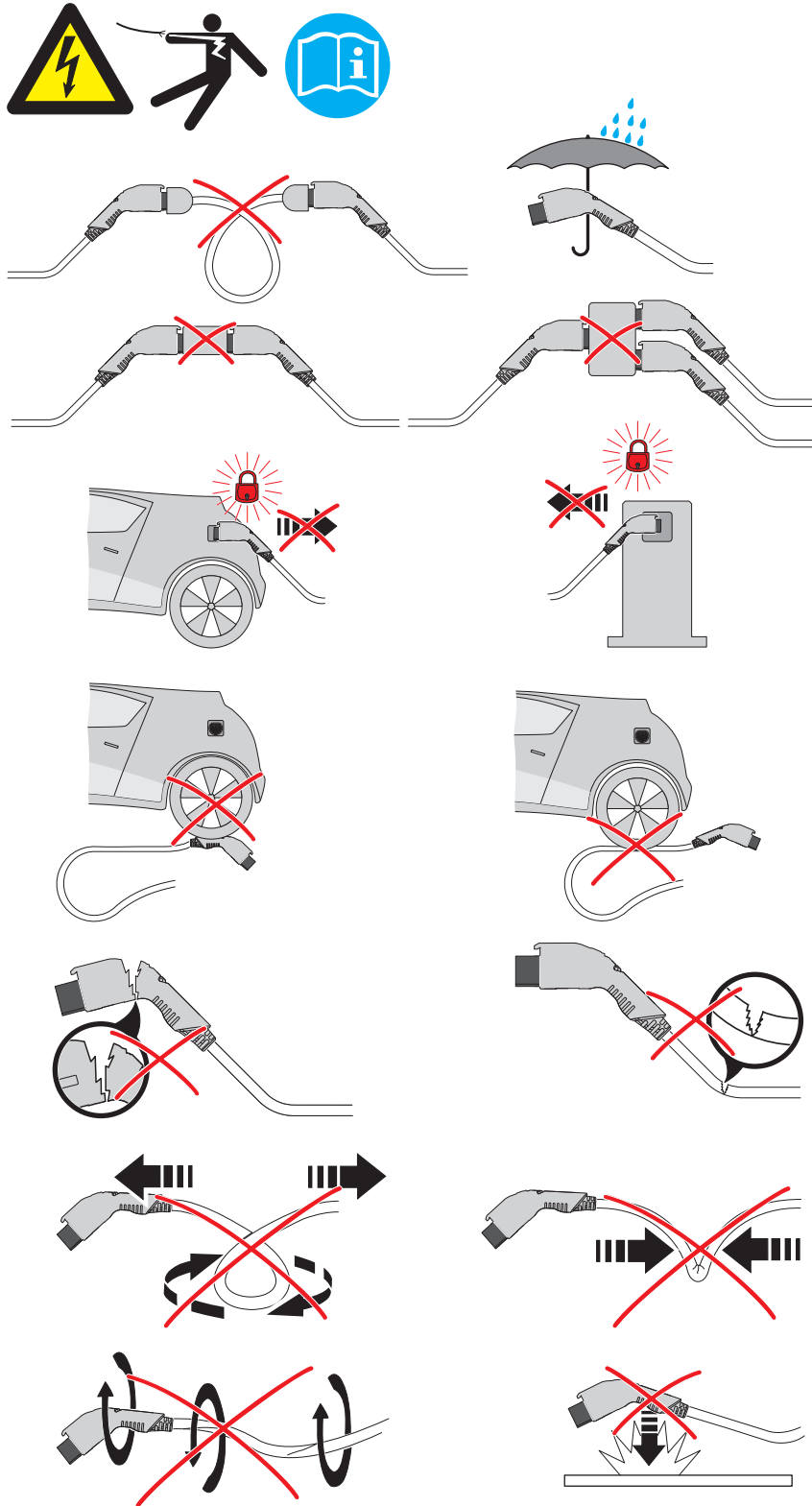

DC charging cable - EV-T1L2CC-DC125A-25,0FT1ASBK01 - 1628114

Approvals

Approvals

Approvals

cULus Recognized

Ex Approvals

Approval details

cULus Recognized  http://database.ul.com/cgi-bin/XYV/template/LISEXT/1FRAME/index.htm E473195-20160308	
Nominal voltage UN	600 V
Nominal current IN	125 A
mm ² /AWG/kcmil	1

Phoenix Contact 2018 © - all rights reserved
<http://www.phoenixcontact.com>

PHOENIX CONTACT GmbH & Co. KG
Flachsmarktstr. 8
32825 Blomberg
Germany
Tel. +49 5235 300
Fax +49 5235 3 41200
<http://www.phoenixcontact.com>