

# Specification

Part No. : **MA752.B.ABICG.001**  
Product Name : Pantheon Antenna 5in1  
Screw-Mount (Permanent Mount)

Features:

- NEW – Addition of LTE 450MHz band!**
- 2 x 4G/3G/2G MIMO Antenna**  
(450~470MHz, 698~960MHz,  
1710~2170MHz,2300~2700MHz)
  - MIMO 1 & 2 Antennas
  - 3m CFD200 with SMA(M) Connector
- 1 x GPS/GLONASS (L1) Antenna**
  - 3m RG174 with SMA(M) Connector
- 2 x 2.4GHz/5.8GHz Wi-Fi MIMO Antenna**
  - MIMO 1 & 2 Antennas
  - 3m CFD200 with RP-SMA(M) Connectors

IP67 Waterproof  
Front End SAW Filter on GNSS Antenna  
High Efficiency / Peak Gain Outdoor Antenna  
**RoHS Compliant**



## 1. Introduction

The Pantheon MA752.B antenna is an omnidirectional, heavy-duty, fully IP67 waterproof external multi-antenna for use in telematics, transportation and remote monitoring applications. The MA752.B is an upgrade of the MA75x series to include the LTE 450MHz band, an emerging technology used primarily for smart metering and smart city projects.

New fleet management and video location technology demand real-time video uplink and downlink. High efficiency, high gain MIMO antennas are necessary to achieve the high signal to noise ratio and throughput required to solve these challenges.

This unique antenna delivers powerful MIMO antenna technology for worldwide LTE and Wi-Fi 802.11n and emerging 802.11ac, plus GPS/GLONASS for next-generation, high-bandwidth telematics systems.

Taoglas has packed 5 high-efficiency and high-gain antennas in an extremely robust IP67 direct mount antenna package with good isolation (>10dB). The antenna has its own ground-plane and can radiate on any mounting environment like metal or plastic without affecting performance. The cables are low loss allowing for lengths of up to 5 meters (16' 4.8"), critical for buses, trains and other commercial transport applications.

Customized cable and connector are versions available. Contact your regional customer support team for further information.

## 2. Specification Table

4G/3G/2G MIMO1 Antenna									
Frequency (MHz)	LTE450	LTE700	GSM850	GSM900	DCS	PCS	UMTS1	LTE2600	
	450~470	698~806	824~894	880~960	1710~1880	1850~1990	1920~2170	2300~2690	
Efficiency (%)									
In free space	30cm	34.88	48.54	53.64	46.38	42.34	47.56	45.74	35.83
	1M	33.33	45.95	51.22	44.31	38.61	43.37	42.03	32.68
	2M	31.10	42.89	47.03	40.41	34.41	38.16	36.81	28.30
	3M	29.70	39.69	43.59	37.50	30.58	33.75	32.57	24.62
	5M	26.47	34.31	37.10	31.70	24.08	26.47	25.38	18.61
Average Gain(dBi)									
In free space	30cm	-4.58	-3.18	-2.71	-3.36	-3.79	-3.23	-3.41	-4.46
	1M	-4.78	-3.43	-2.91	-3.56	-4.19	-3.63	-3.77	-4.86
	2M	-5.08	-3.73	-3.29	-3.96	-4.69	-4.18	-4.35	-5.49
	3M	-5.28	-4.06	-3.61	-4.29	-5.20	-4.72	-4.88	-6.09
	5M	-5.78	-4.69	-4.31	-5.01	-6.23	-5.77	-5.97	-7.31
Peak Gain(dBi)									
In free space	30cm	-0.60	2.70	2.60	2.44	3.38	3.38	3.35	1.95
	1M	-0.80	2.50	2.40	2.24	2.98	2.98	3.05	1.55
	2M	-1.10	2.20	2.10	1.84	2.48	2.48	2.45	0.95
	3M	-1.30	1.80	1.70	1.54	1.93	1.89	1.85	0.43
	5M	-1.80	1.20	1.00	0.84	0.88	0.88	0.75	-0.77
4G/3G/2G MIMO2 Antenna									
Efficiency (%)									
In free space	30cm	36.01	42.40	55.38	47.47	39.35	48.57	45.79	33.92
	1M	34.38	40.18	52.89	45.34	35.87	44.31	42.10	30.93
	2M	32.08	37.50	48.57	41.35	31.97	38.99	36.86	26.81
	3M	30.64	35.09	45.02	38.59	28.90	35.02	32.70	23.31
	5M	27.31	29.98	38.32	32.43	22.37	27.05	25.43	17.62
Average Gain(dBi)									
In free space	30cm	-4.44	-3.86	-2.58	-3.25	-4.11	-3.14	-3.41	-4.71
	1M	-4.64	-4.10	-2.78	-3.45	-4.51	-3.54	-3.78	-5.11
	2M	-4.94	-4.40	-3.15	-3.85	-5.01	-4.09	-4.35	-5.74
	3M	-5.14	-4.67	-3.48	-4.15	-5.44	-4.56	-4.88	-6.35
	5M	-5.64	-5.36	-4.18	-4.90	-6.55	-5.68	-5.97	-7.56
Peak Gain(dBi)									
In free space	30cm	-0.22	2.57	2.63	2.96	3.38	3.38	3.09	1.86
	1M	-0.42	2.37	2.43	2.76	2.98	2.98	2.79	1.46
	2M	-0.72	2.07	2.13	2.36	2.48	2.48	2.19	0.86
	3M	-0.92	1.77	1.73	2.06	1.98	1.98	1.59	0.26
	5M	-1.42	1.07	1.03	1.26	0.88	0.88	0.59	-1.04
Envelope Correlation Coefficient		All bands < 0.3							
Polarization		Linear							
Impedance		50Ω							
Cable		3m CFD-200 standard, fully customizable							
Connector		SMA Male Straight, fully customizable							

GPS/GLONASS		
Center Frequency fc	GPS:1575.42±3 MHz	Glonass:1602±0.5 MHz
Gain(dBic)	0.7 (typical)	1.3 (typical)
VSWR(@Center Frequency)	< 2	
Polarization	RHCP	
Impedance	50Ω	
Antenna size	25x25x4mm	
Cable	3m RG174 standard, fully customizable	
Connector	SMA Male Straight, fully customizable	

LNA Electrical Properties		
Center Frequency fc	GPS:1575.42±3 MHz	Glonass:1602±0.5 MHz
Gain @3V	28 dB typical	28 dB typical
DC Power Input	3~5V	
Noise Figure @3V	2.69dB typical	3.17 typical
Power Consumption @3V	15 mA	

MECHANICAL	
Antenna Dimensions	Height: 82.4mm x Diameter: 143.2mm
Casing	PC
Waterproof	IP67
Base and thread	Zinc Alloy
Thread diameter	M30 x 2 (30mm)
Nut	Nickel Plated Steel
Foam	3M 9448HK
Weight	1.16kg / 1pcs
Recommended Torque for Mounting	49N·m
Max Torque for Mounting	58.8N·m

ENVIRONMENTAL	
Operation Temperature	-40°C to 85°C
Storage Temperature	-40°C to 90°C
Humidity	Non-condensing 65°C 95% RH

2.4GHz/5.8GHz Wi-Fi Antenna			
Frequency (MHz)		2400~2500	4900~5850
Efficiency (%)			
MIMO_1	30cm	87.12	70.14
	1M	79.46	60.32
	2M	69.21	48.88
	3M	60.28	39.64
	5M	43.95	26.03
MIMO_2	30cm	84.18	69.03
	1M	76.77	59.34
	2M	66.87	48.07
	3M	58.24	38.98
	5M	43.05	25.58
Average Gain(dBi)			
MIMO_1	30cm	-0.60	-1.55
	1M	-1.00	-2.21
	2M	-1.60	-3.12
	3M	-2.20	-4.03
	5M	-3.57	-5.52
MIMO_2	30cm	-0.75	-1.62
	1M	-1.15	-2.27
	2M	-1.75	-3.19
	3M	-2.35	-4.10
	5M	-3.66	-5.93
Peak Gain(dBi)			
MIMO_1	30cm	6.60	7.83
	1M	6.20	7.23
	2M	5.60	6.33
	3M	5.00	5.53
	5M	3.53	3.77
MIMO_2	30cm	7.36	7.93
	1M	6.96	7.23
	2M	6.36	6.33
	3M	5.76	5.43
	5M	4.28	3.69
Envelope Correlation Coefficient	All bands < 0.3		
Impedance	50Ω		
Polarization	Linear		
VSWR	< 3		
Cable	3 meters CFD-200 standard, fully customizable		
Connector	SMA(M) RP Straight , fully customizable		

### 3. LTE MIMO

#### 3.1. LTE MIMO1 and MIMO2 Characteristics

##### 3.1.1. Return Loss

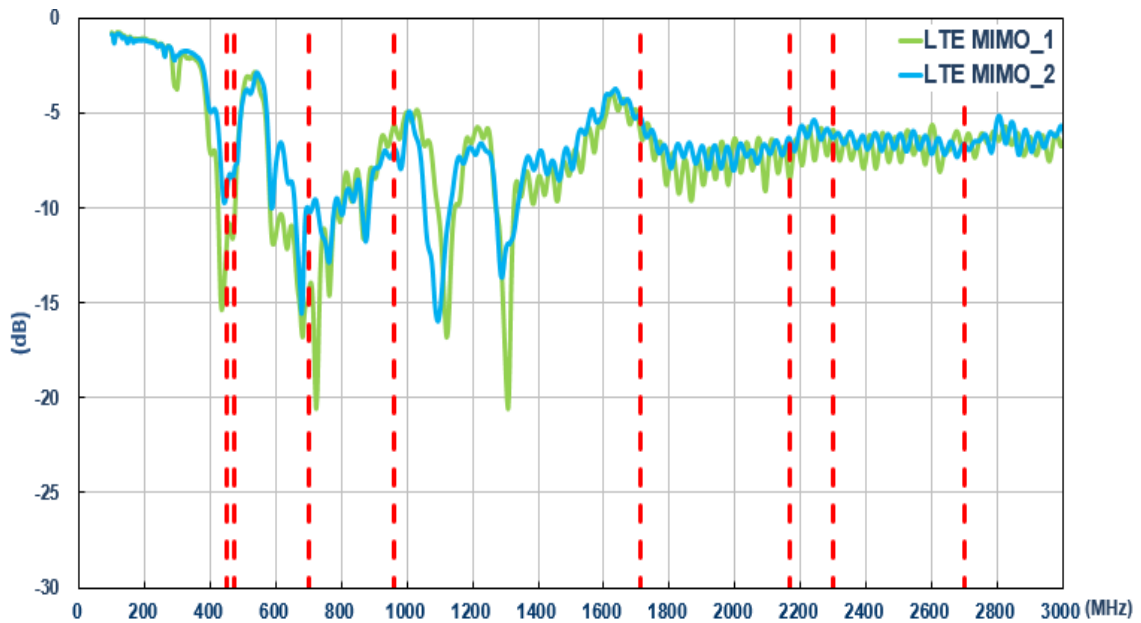

##### 3.1.2. Isolation

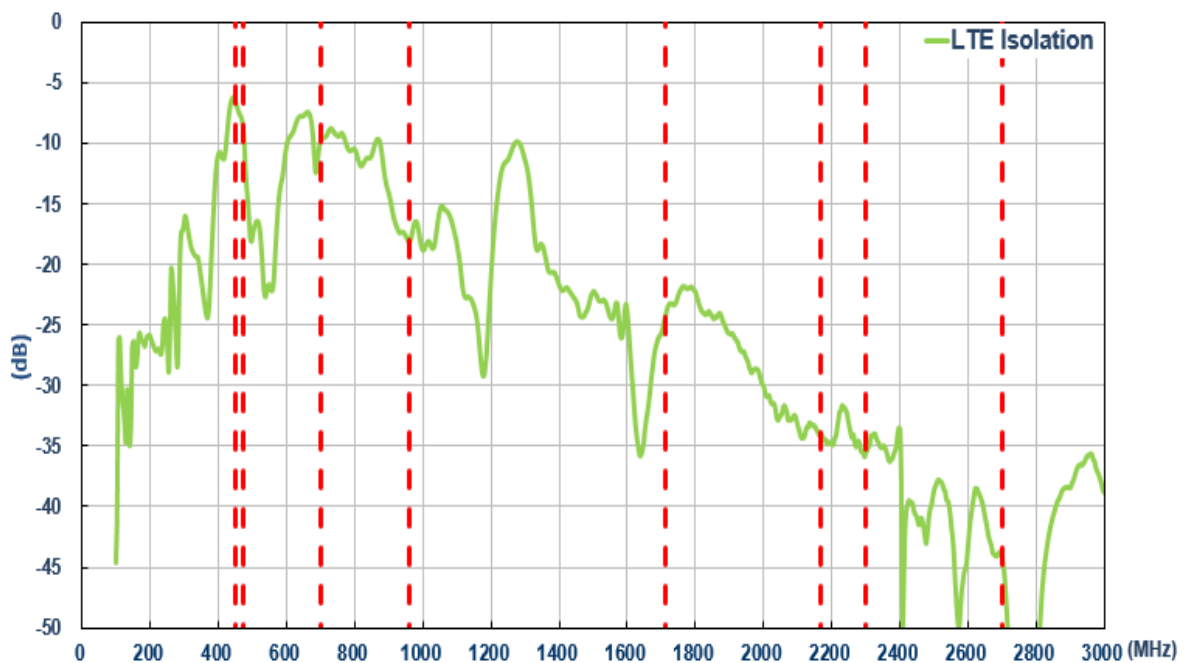

### 3.1.3. ECC

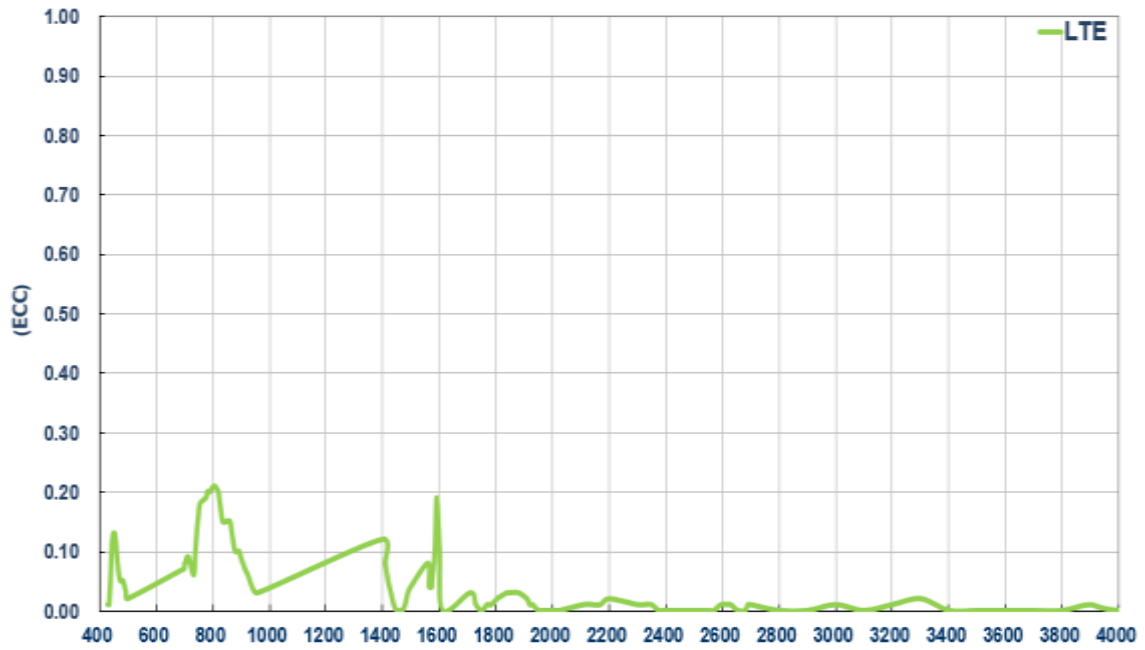

### 3.1.4. Efficiency

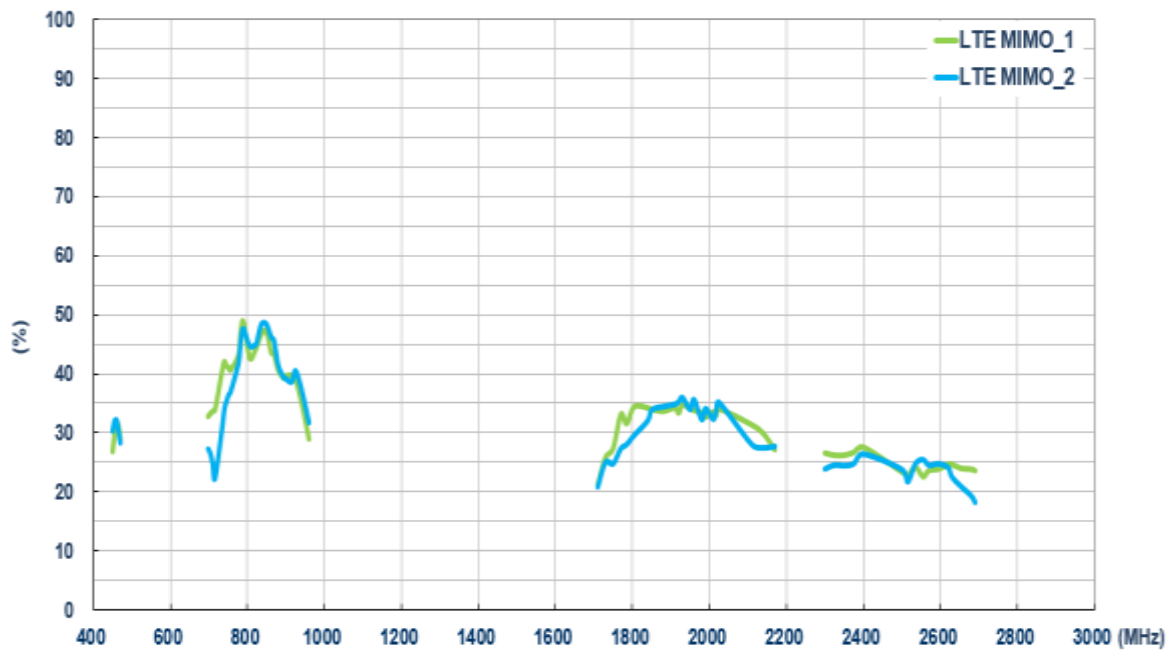

### 3.1.5. Average Gain

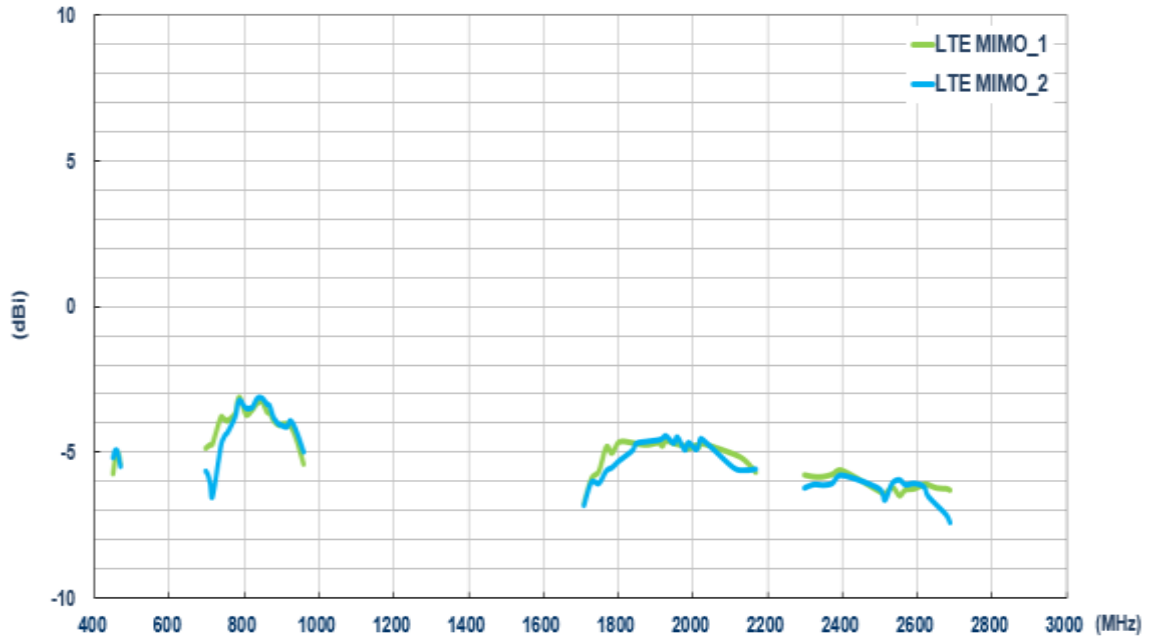

### 3.1.6. Peak Gain

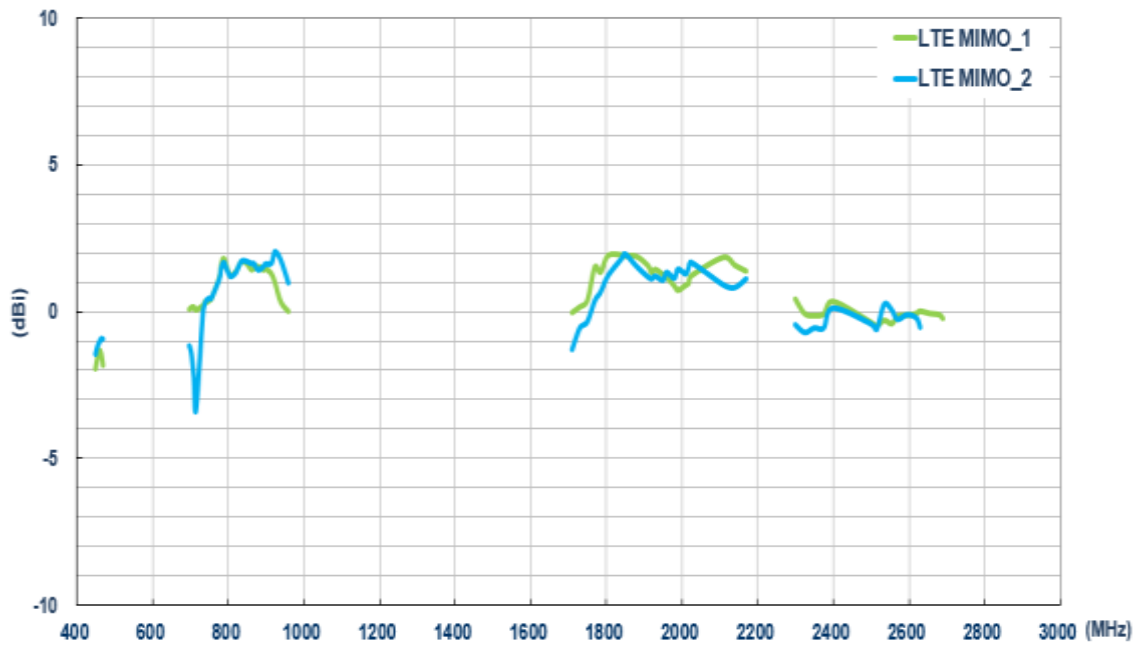



### 3.2. Radiation Pattern

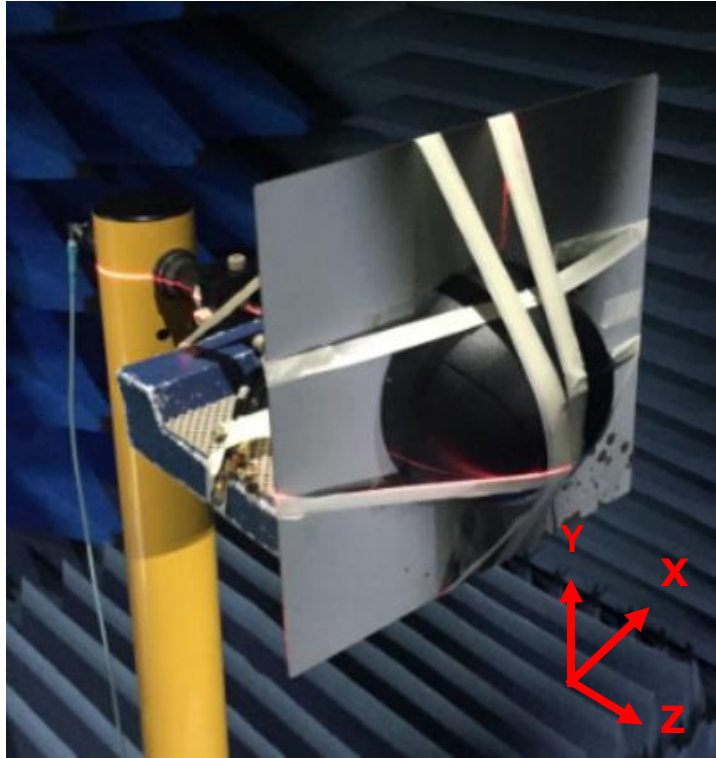

### 3.2.1 LTE MIMO1 2D Radiation Pattern

#### XY Plane

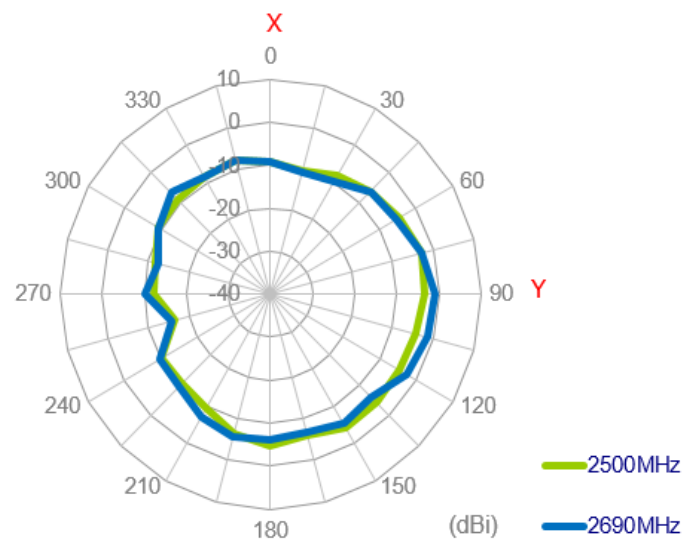
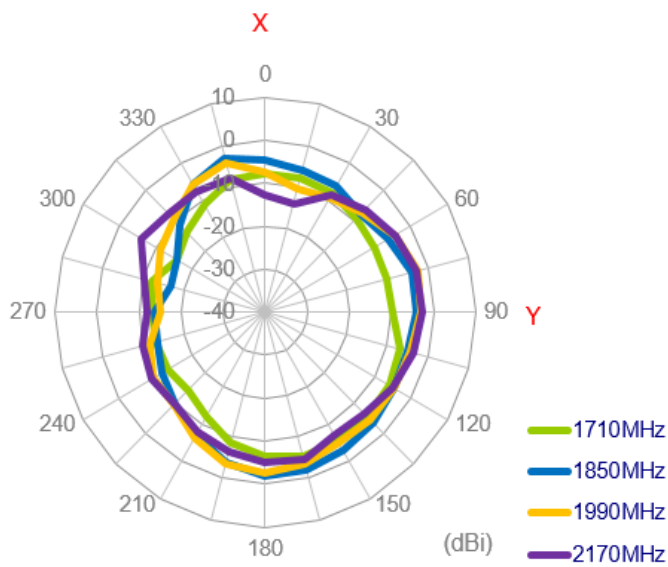
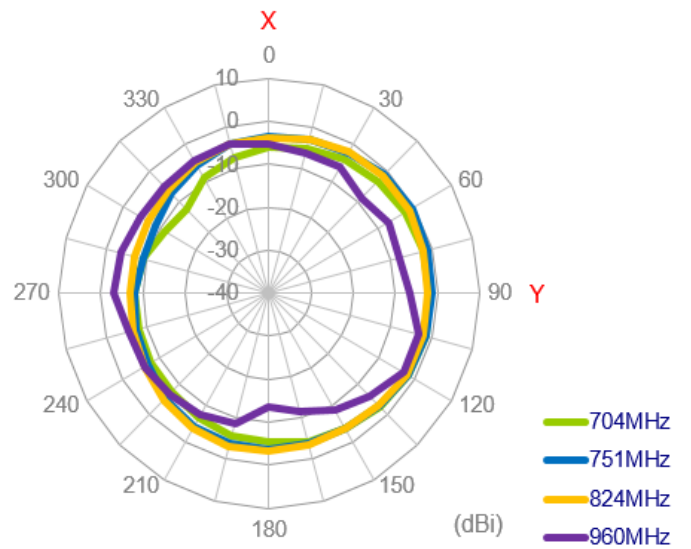
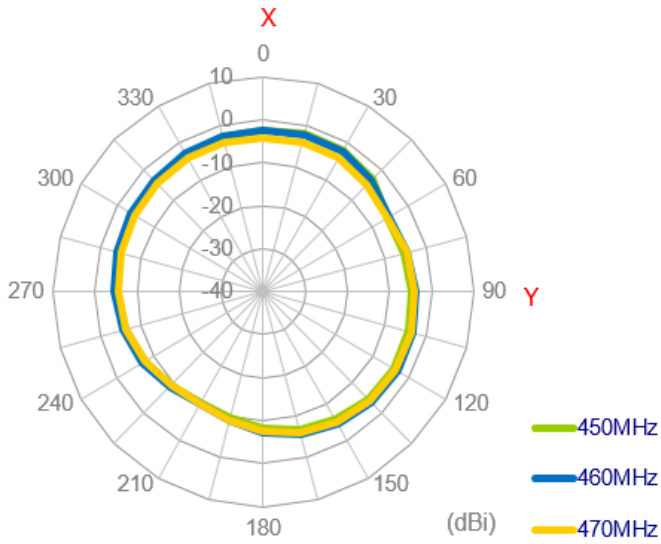

### XZ Plane

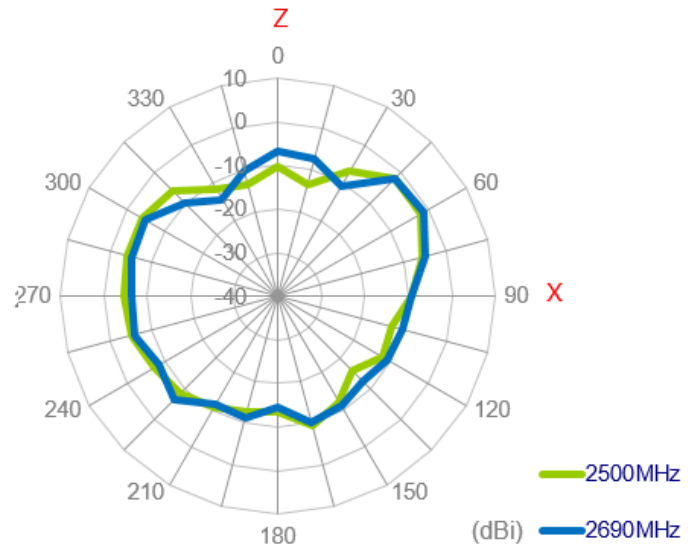
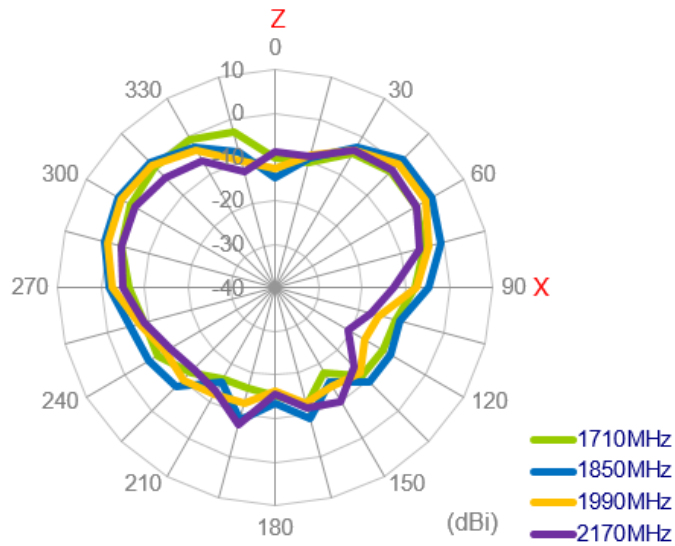
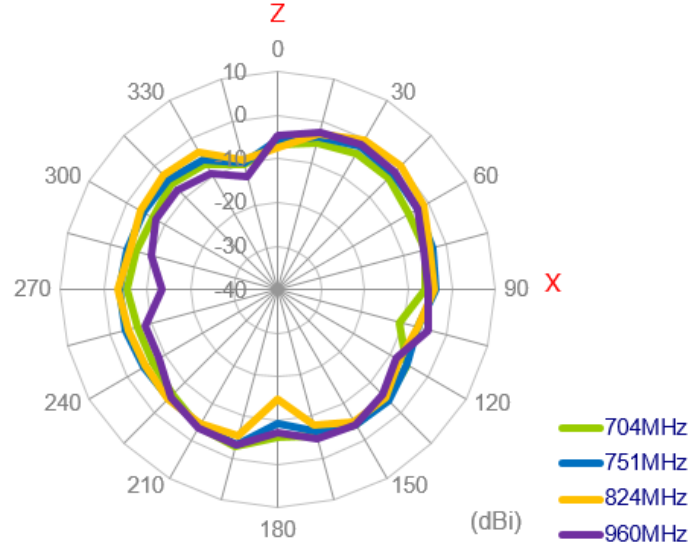
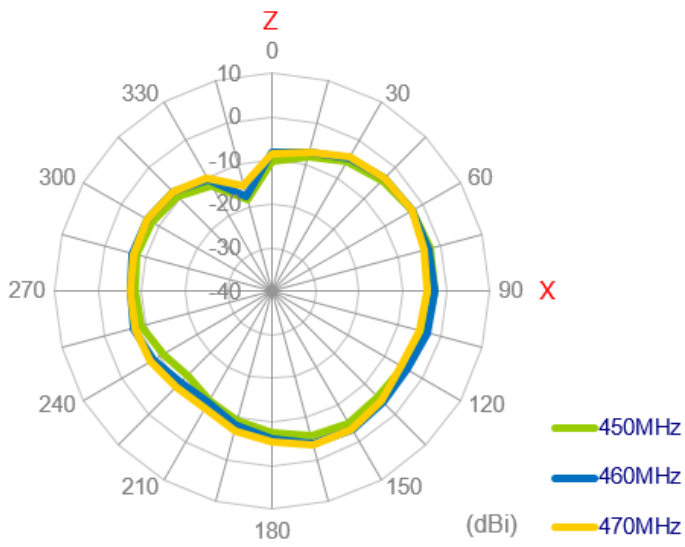

### YZ Plane

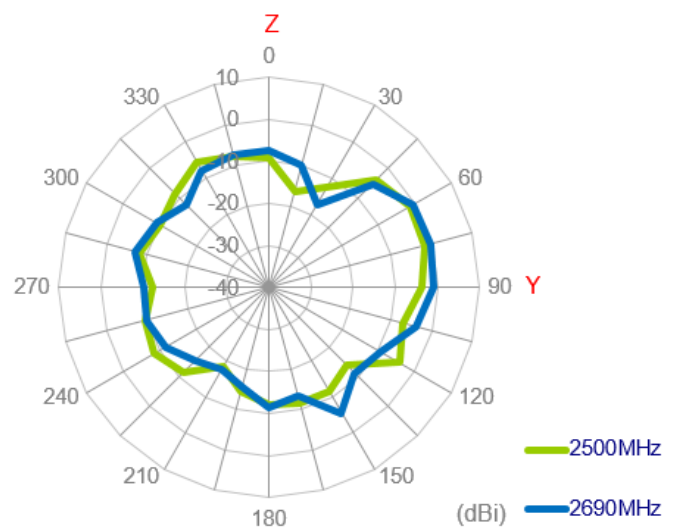
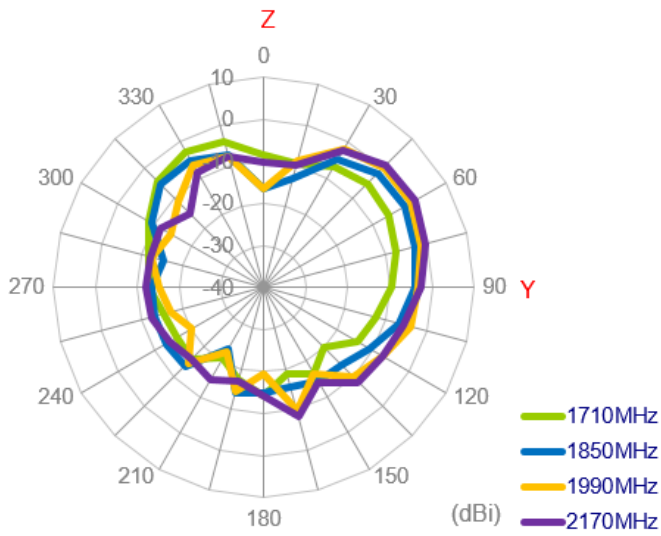
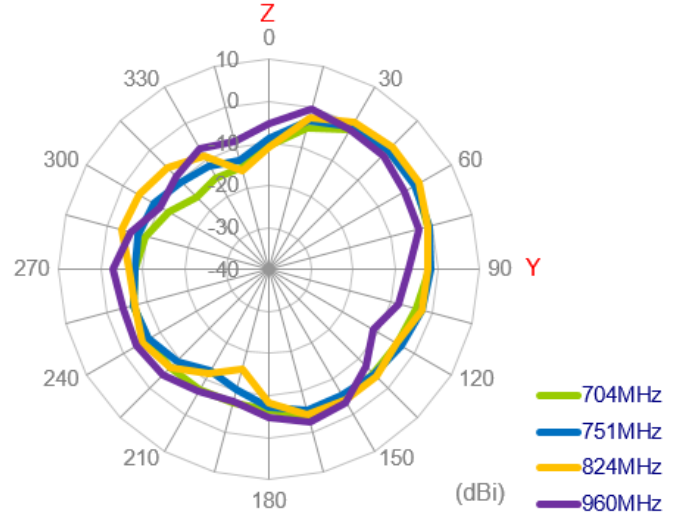
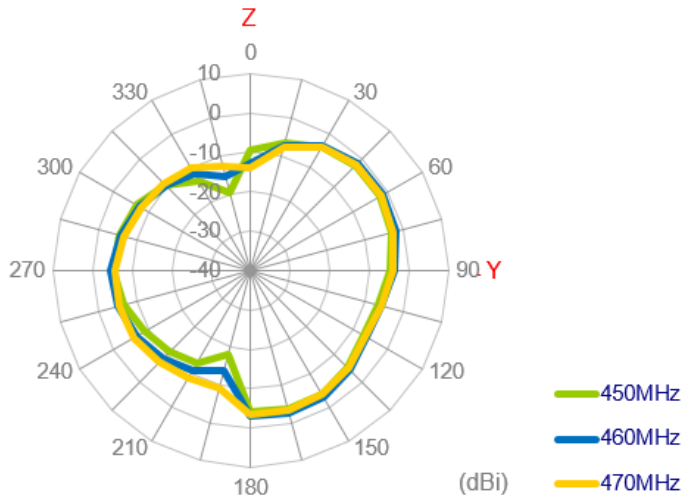

### 3.2.2 LTE MIMO2 2D Radiation Pattern

#### XY Plane

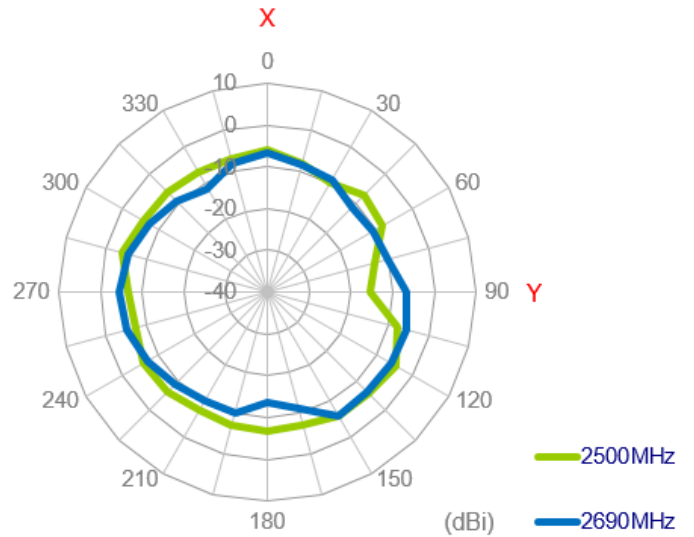
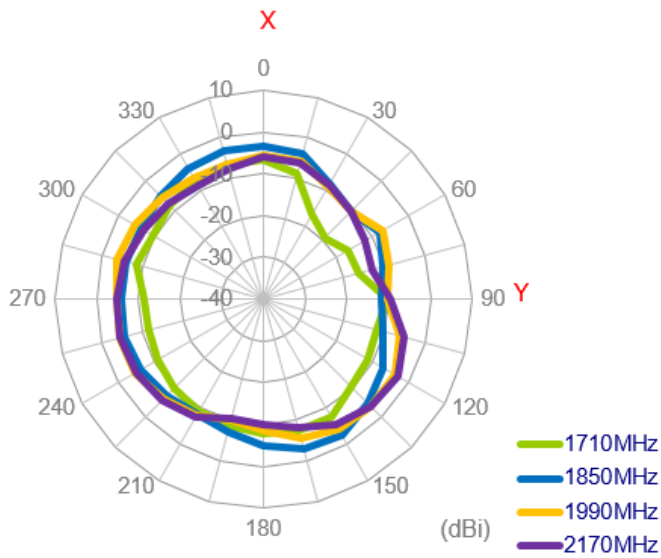
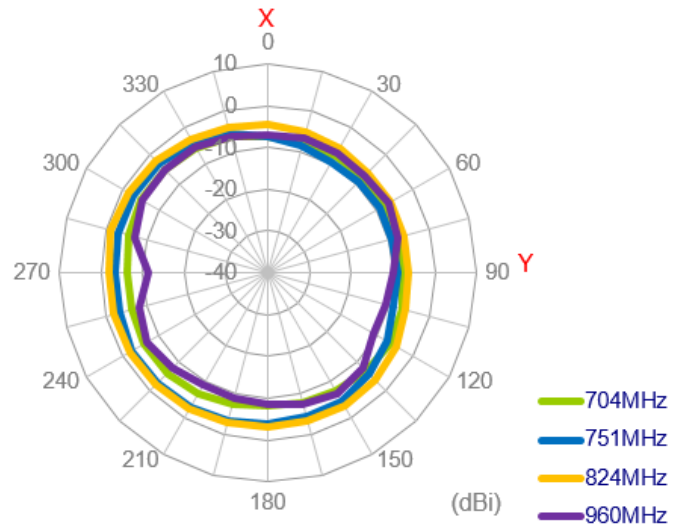
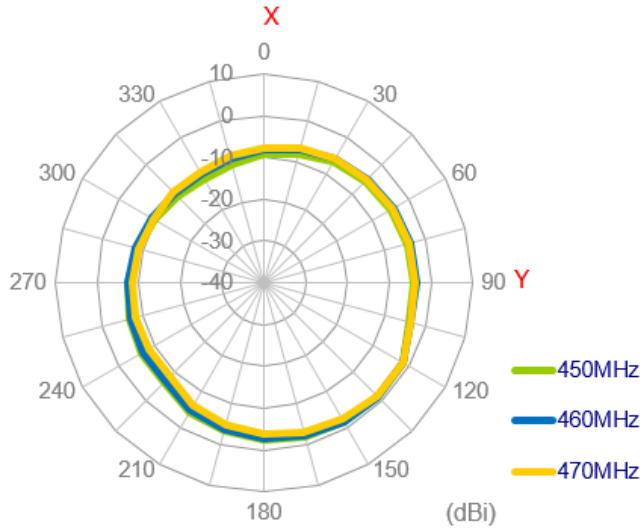

### XZ Plane

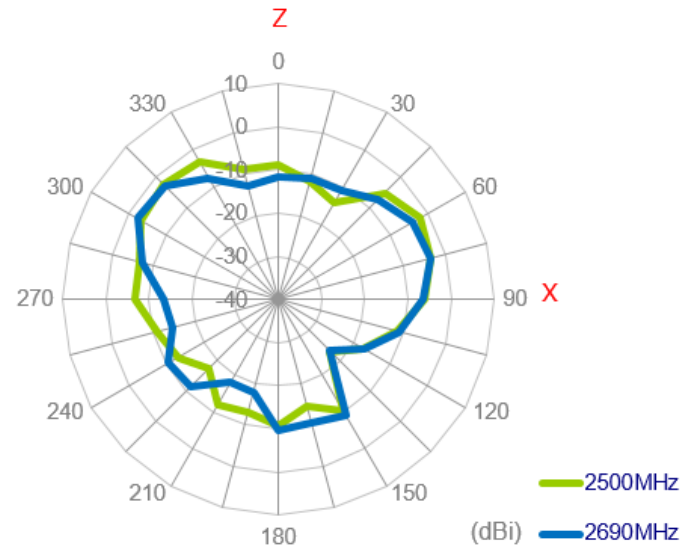
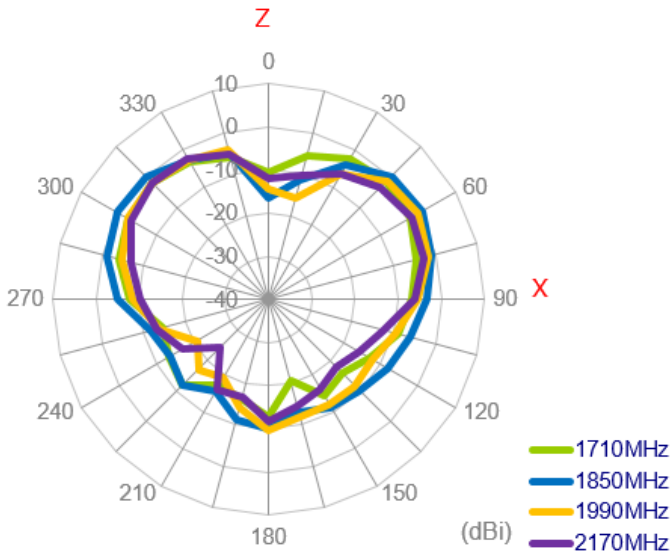
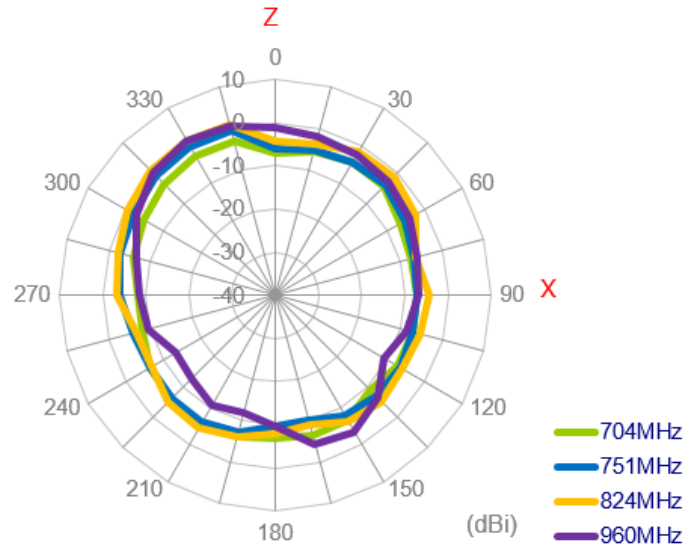
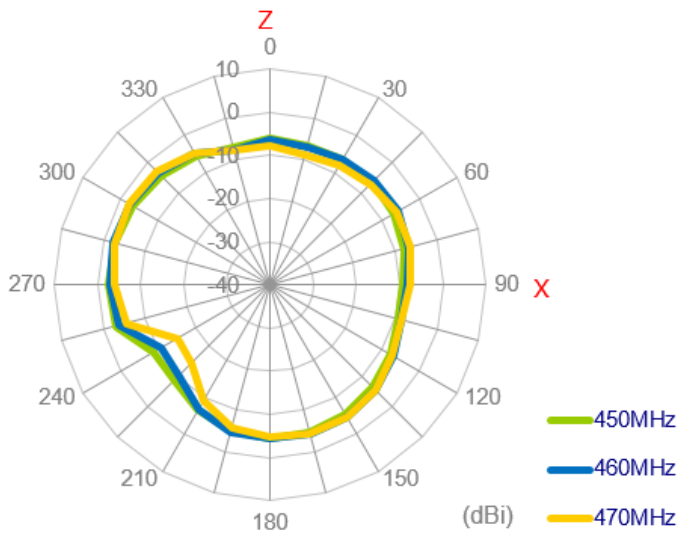

## YZ Plane

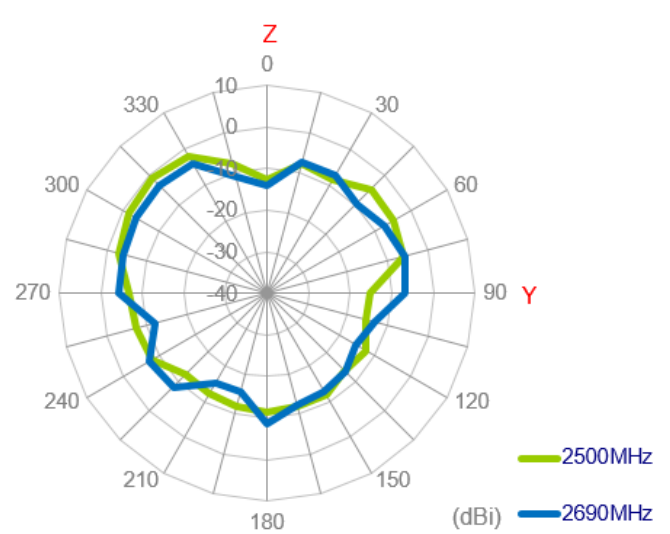
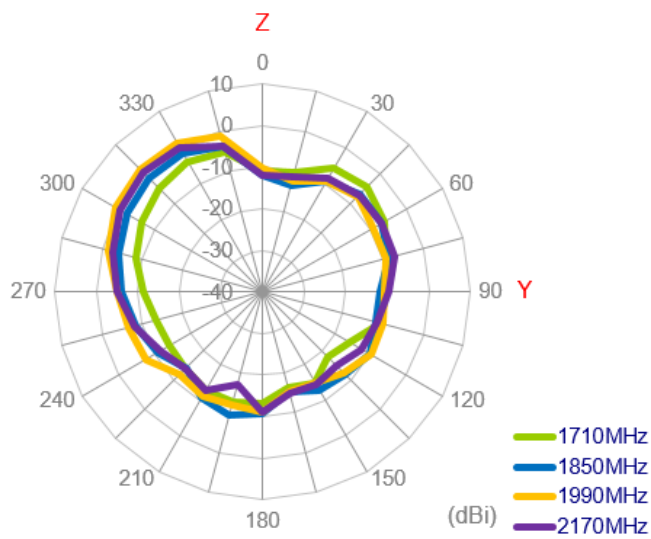
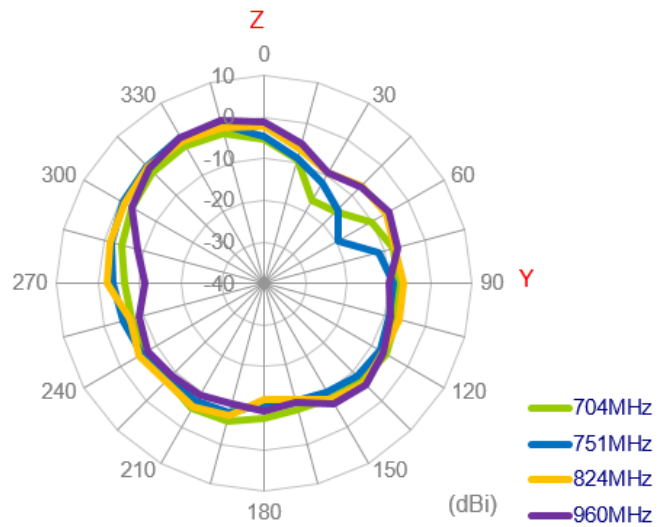
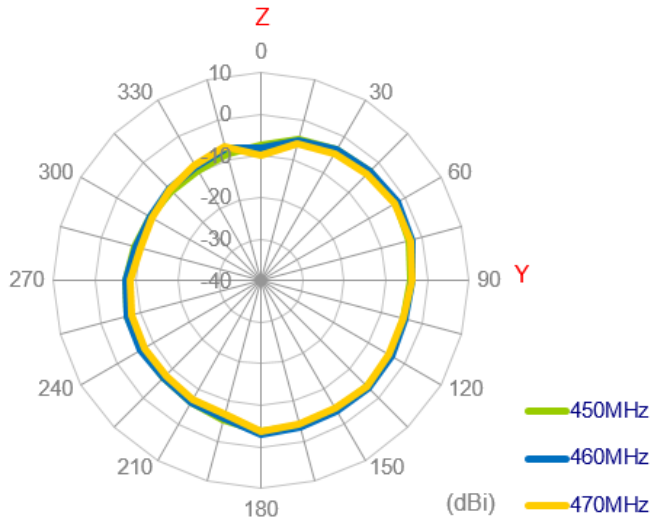

### 3.2.3 LTE MIMO1 3D Radiation Pattern

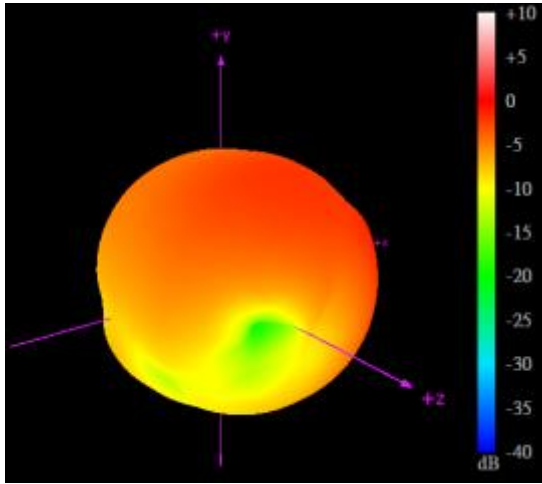

450MHz

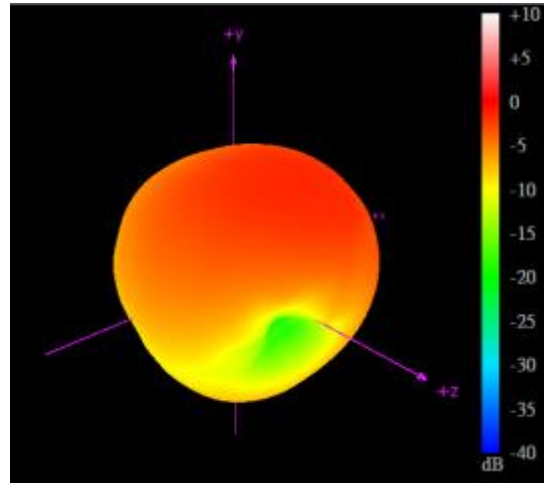

470MHz

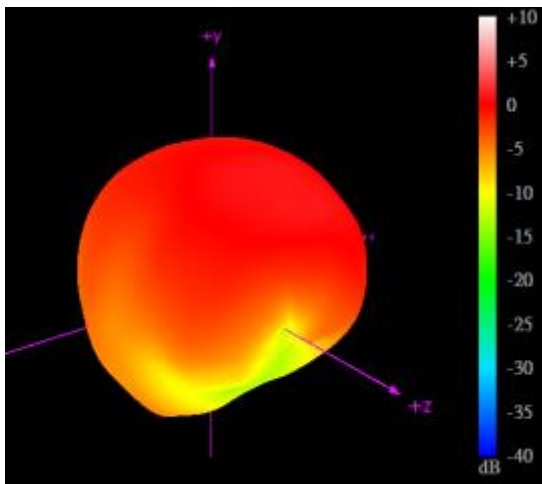

704MHz

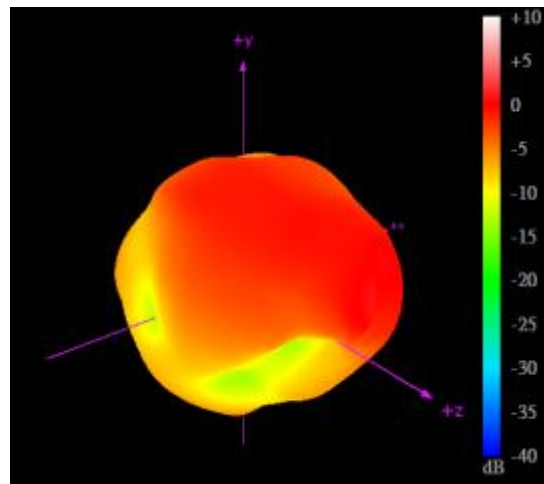

960MHz



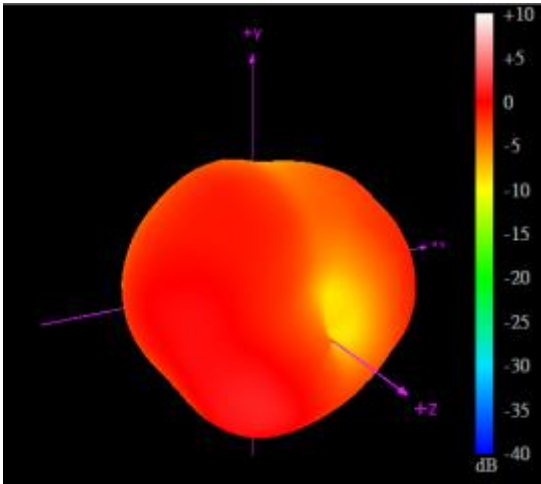

1710MHz

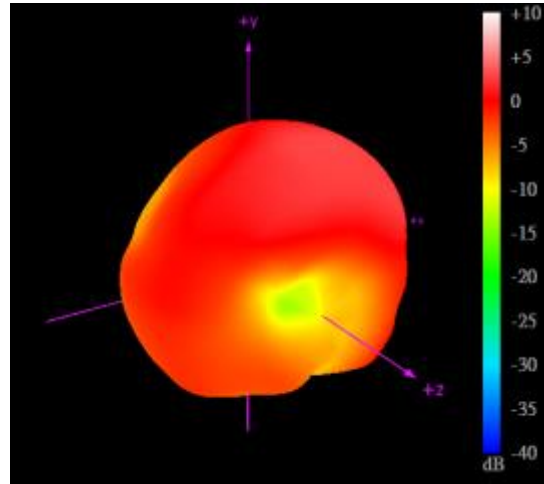

2170MHz

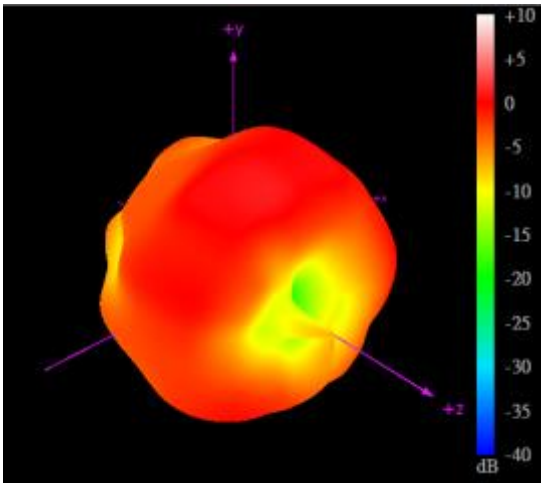

2500MHz

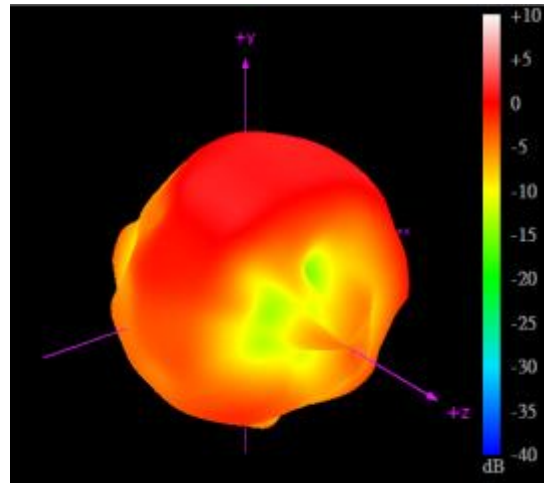

2690MHz

### 3.2.4 LTE MIMO2 3D Radiation Pattern

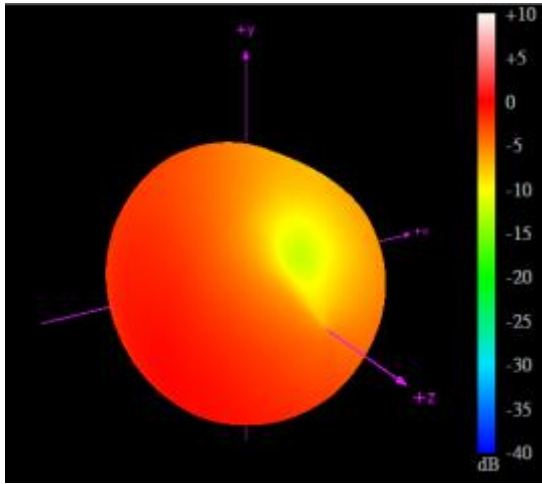

450MHz

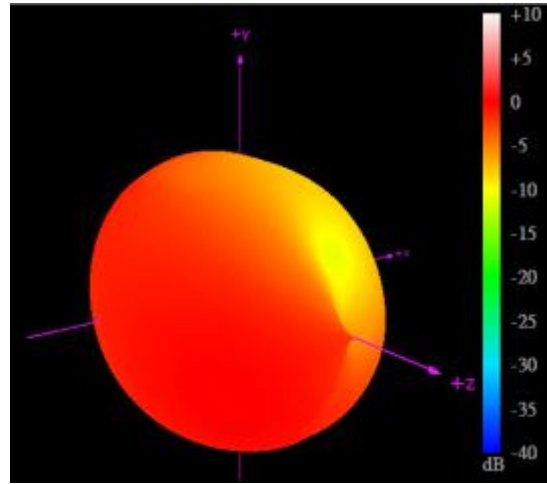

470MHz

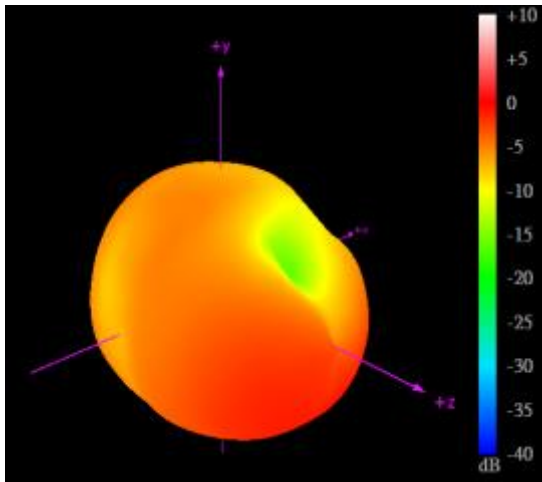

704MHz

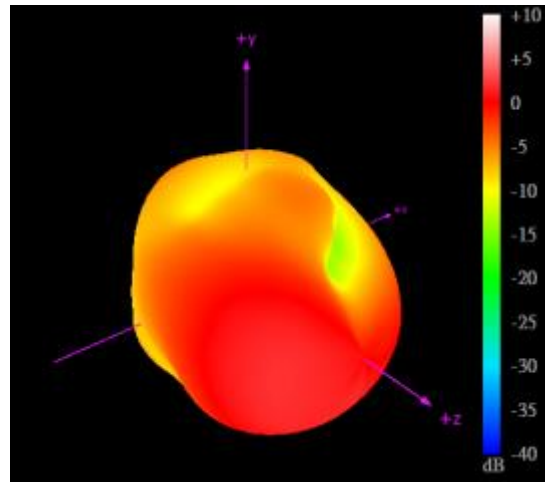

960MHz

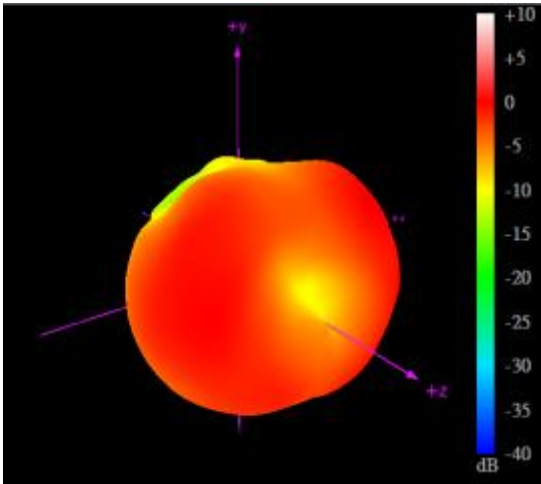

1710MHz

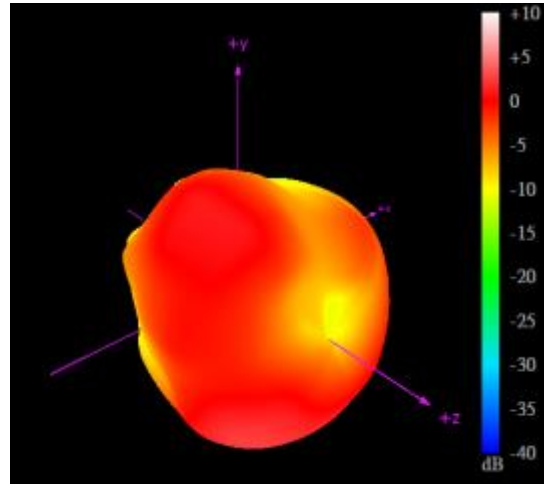

2170MHz

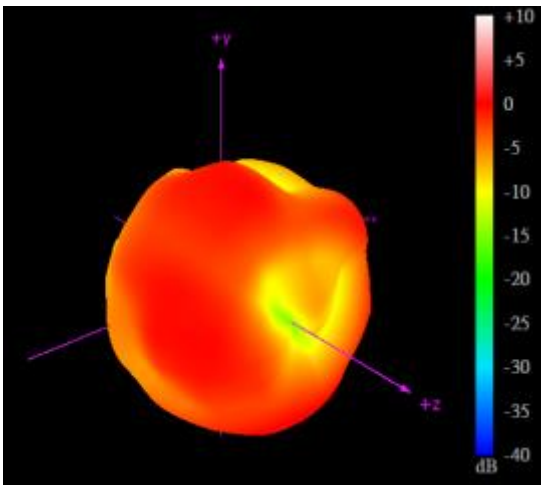

2500MHz

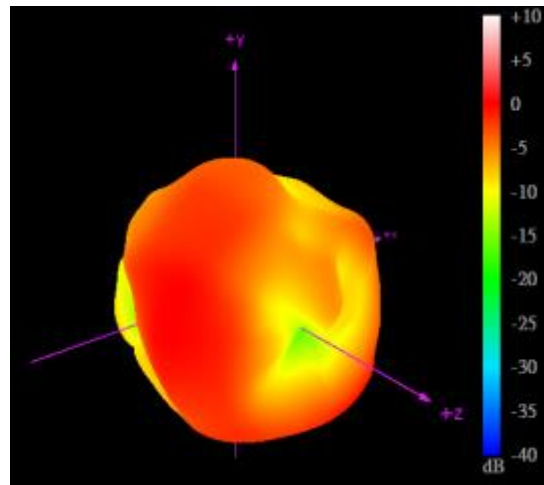

2690MHz

## 4.2.4/5.8GHz MIMO

### 4.1. 2.4/5.8GHz MIMO1 and MIMO2 Characteristics

#### 4.1.1. Return Loss

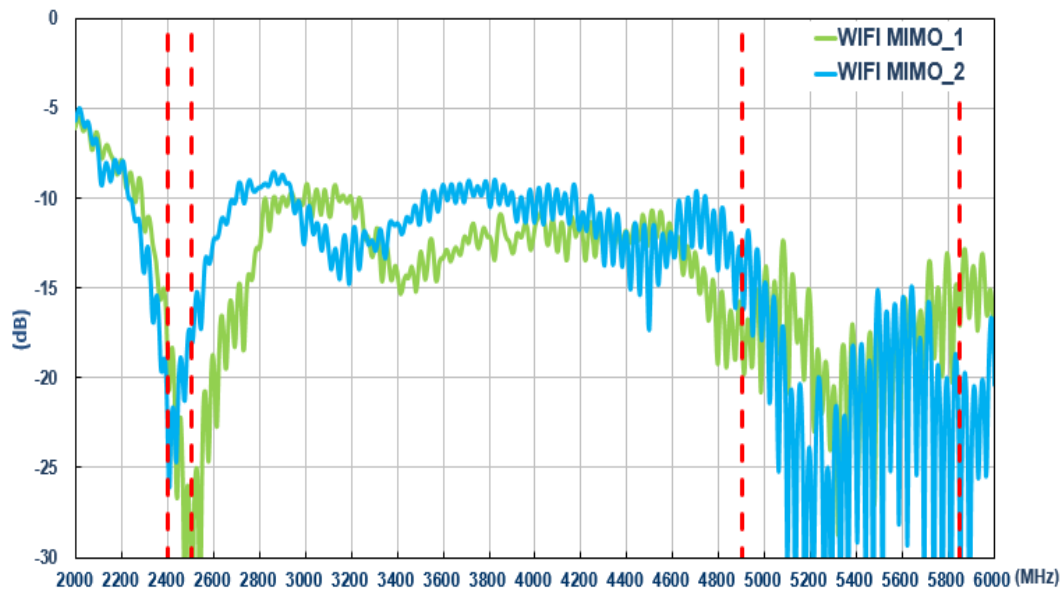

#### 4.1.2. Isolation

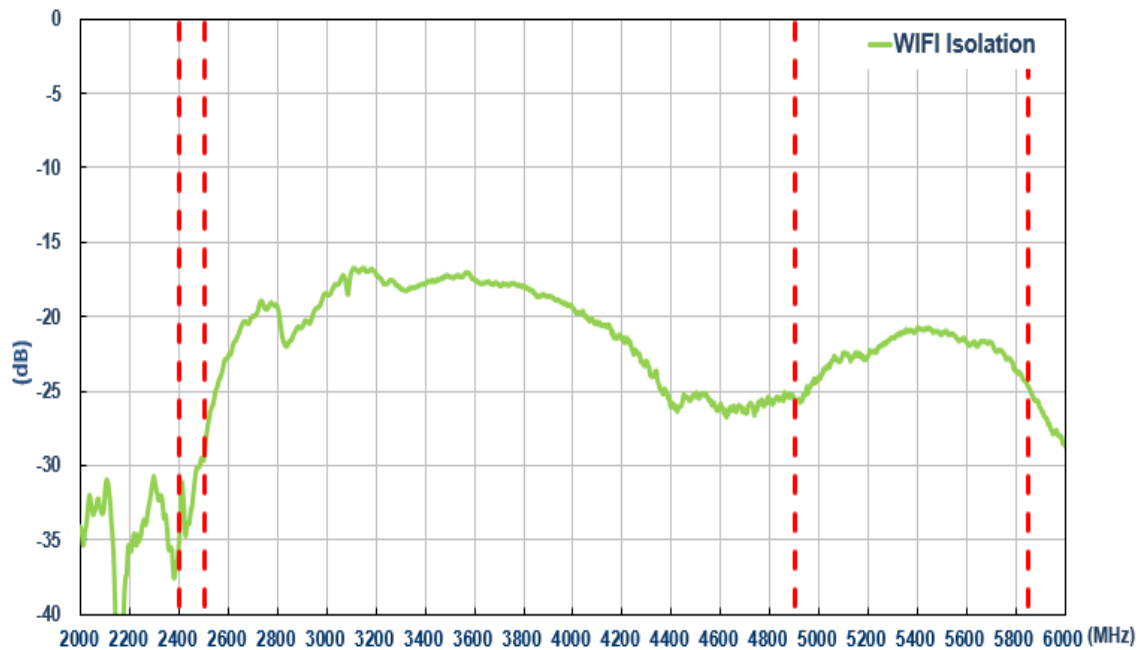

### 4.1.3. ECC

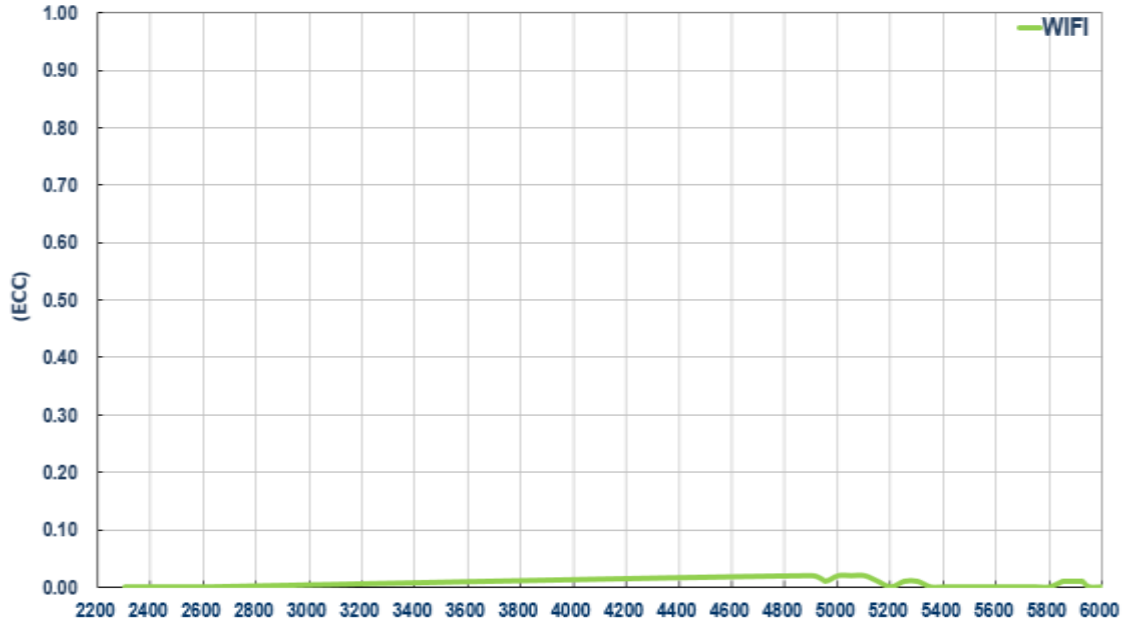

### 4.1.4. Efficiency

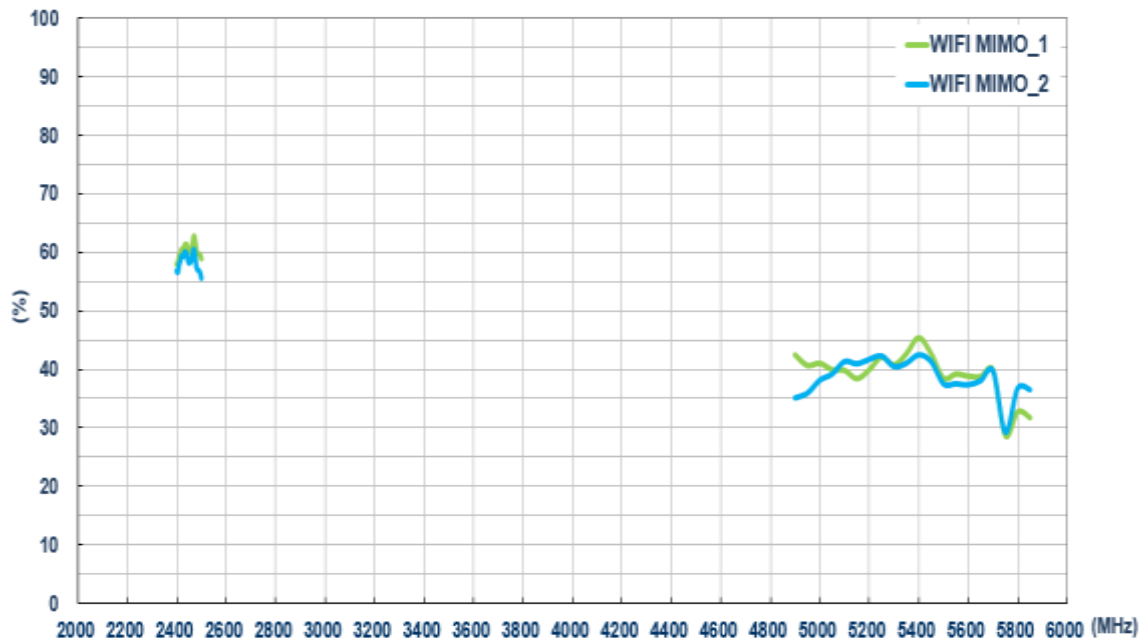

#### 4.1.5. Average Gain

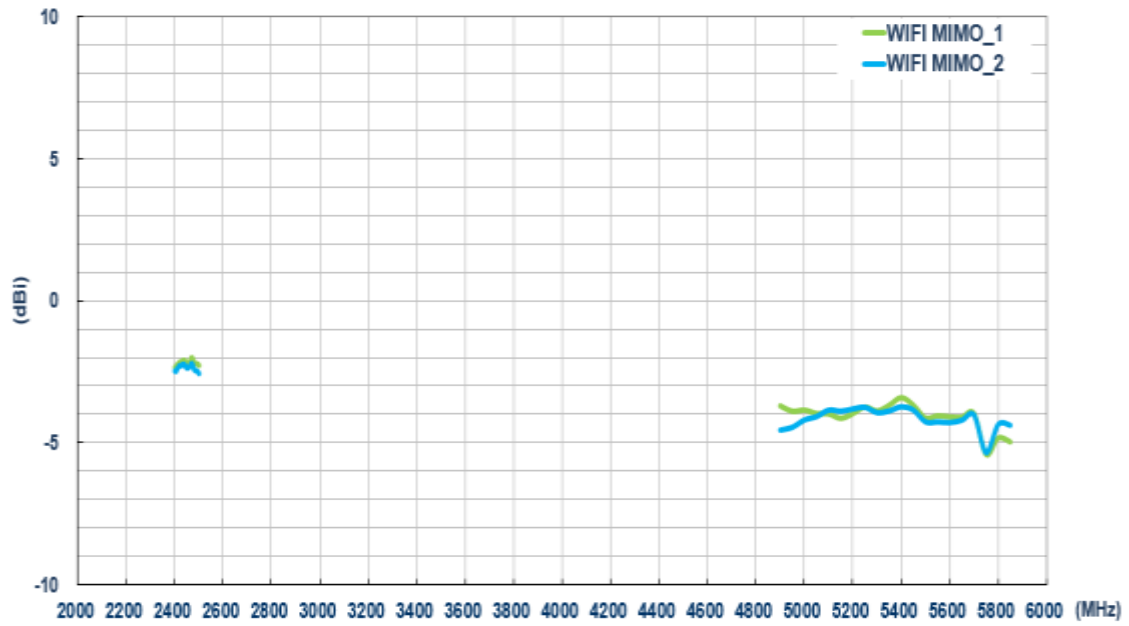

#### 4.1.6. Peak Gain

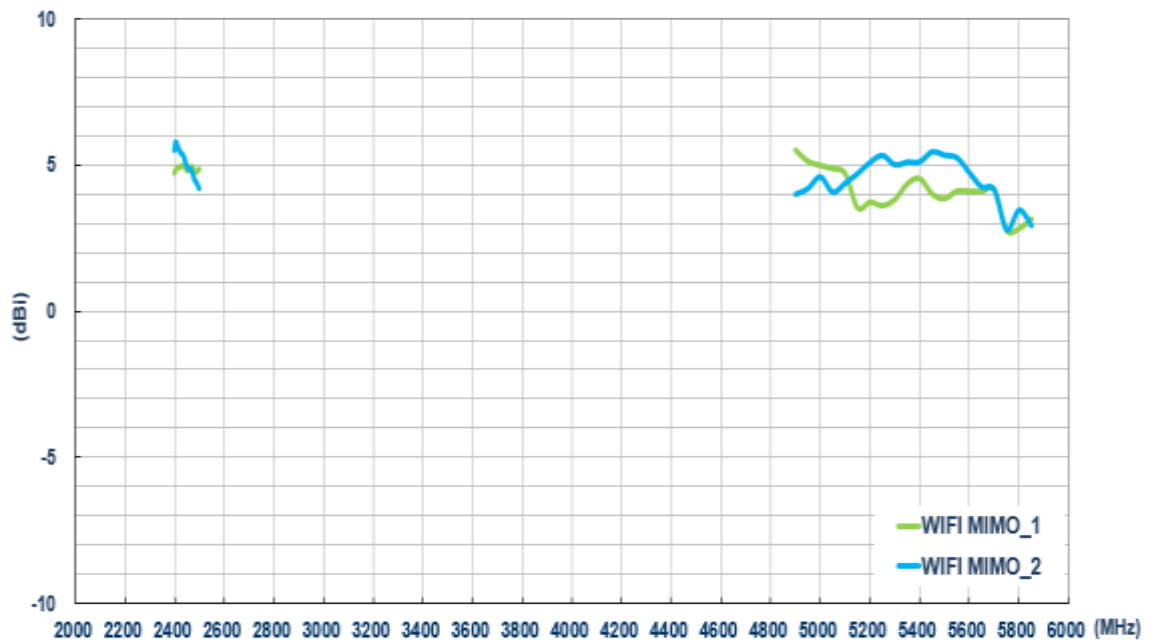

## 4.2. Radiation Patterns

### 4.2.1. 2.4/5.8GHz MIMO1 Radiation Pattern

#### XY Plane

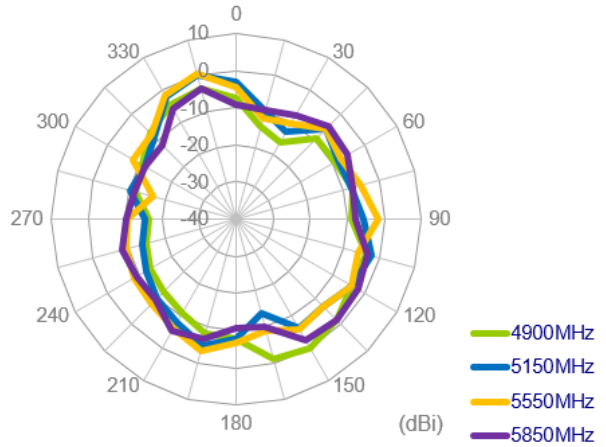
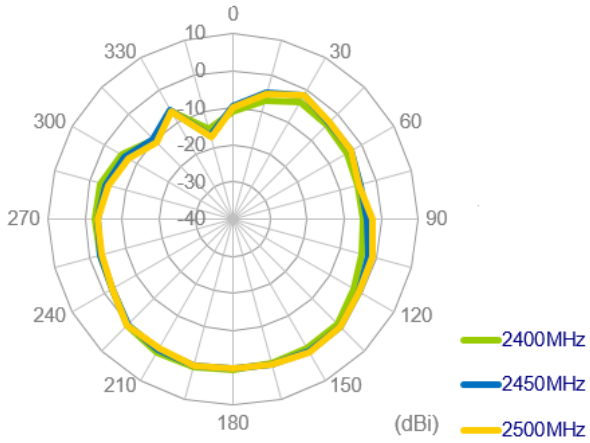

#### XZ Plane

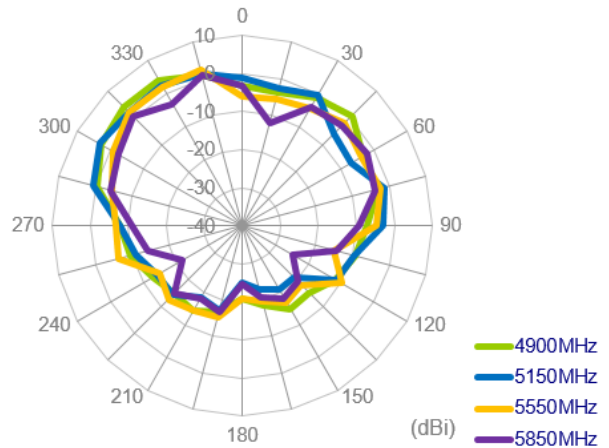
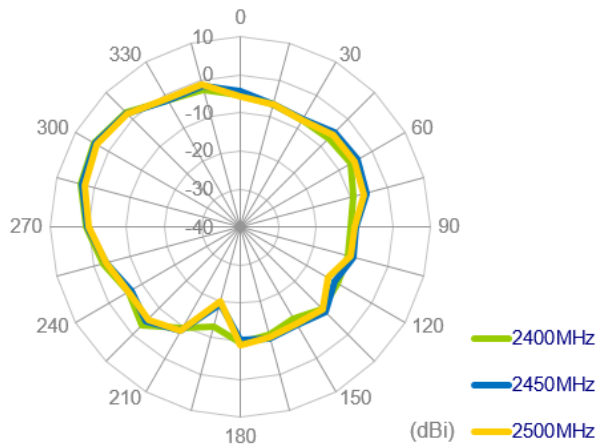

#### YZ Plane

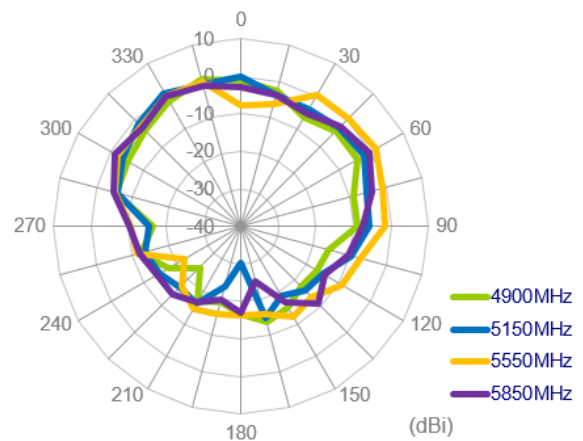
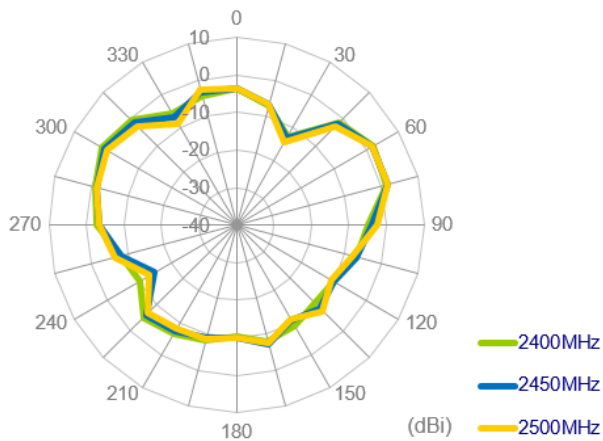

### 4.2.2. 2.4/5.8GHz MIMO2 Radiation Pattern

#### XY Plane

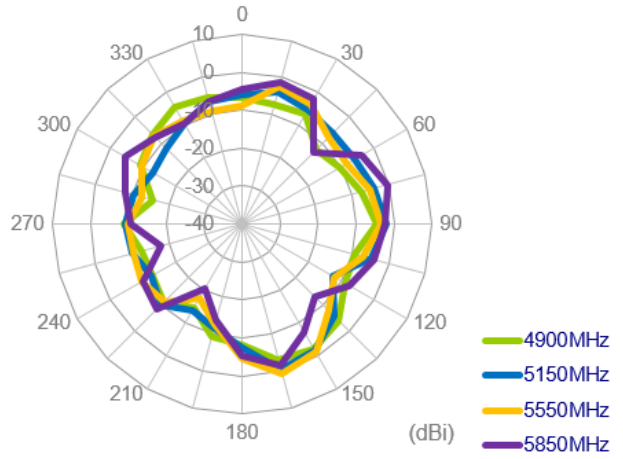
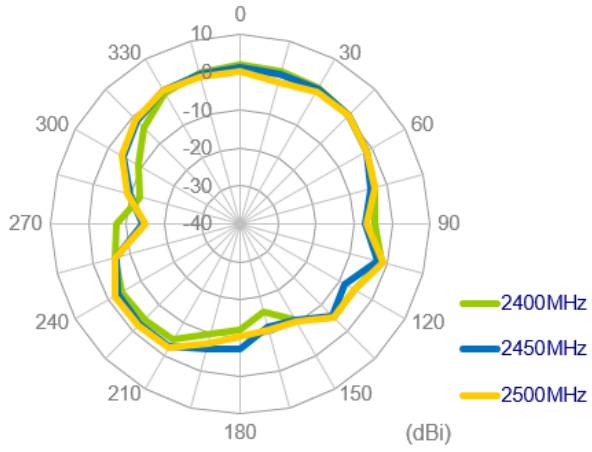

#### XZ Plane

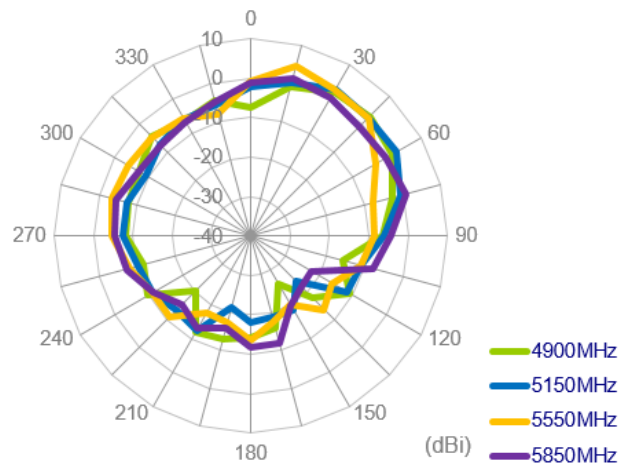
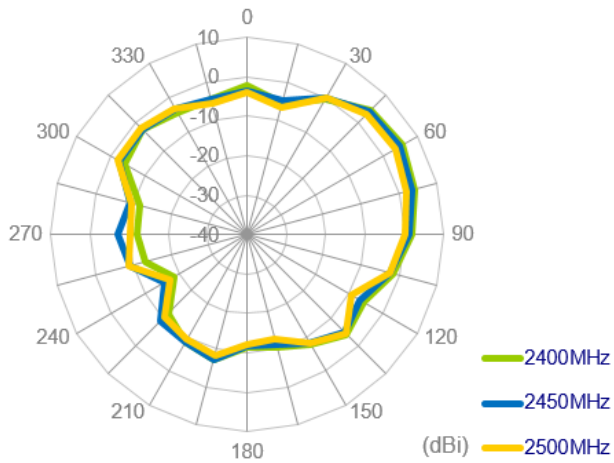

#### YZ Plane

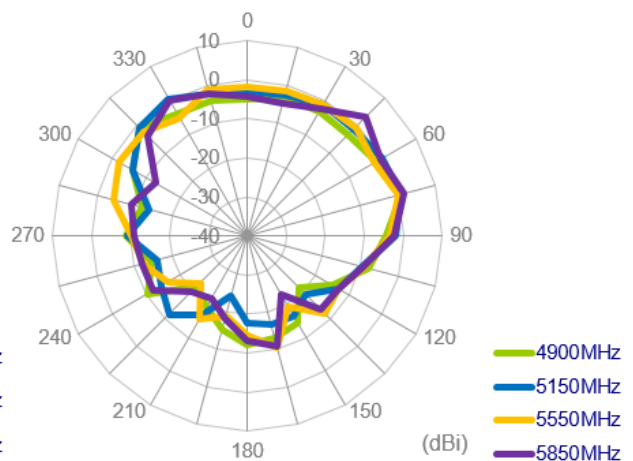
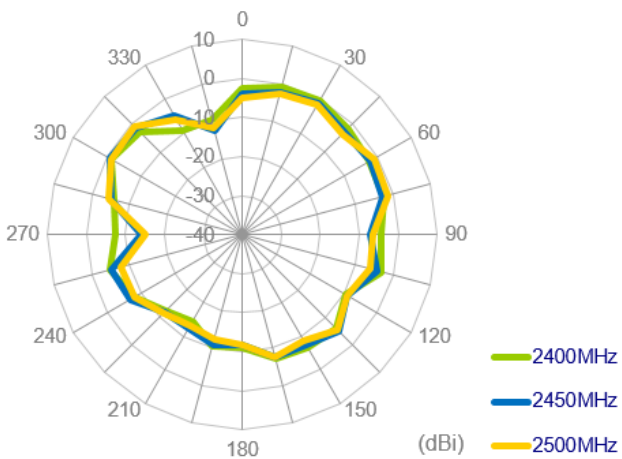



### 4.2.1. 2.4/5.8GHz MIMO1 3D Radiation Pattern

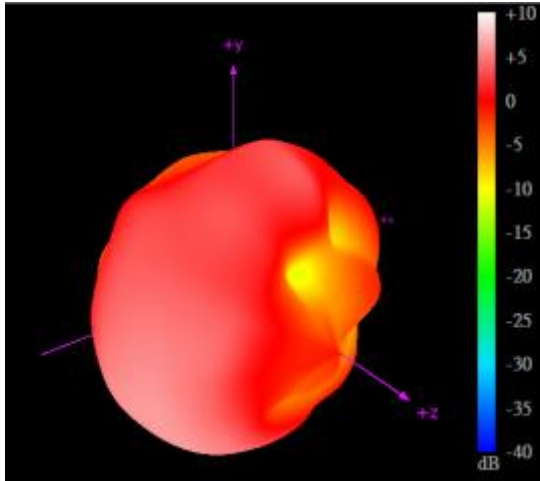

2400MHz

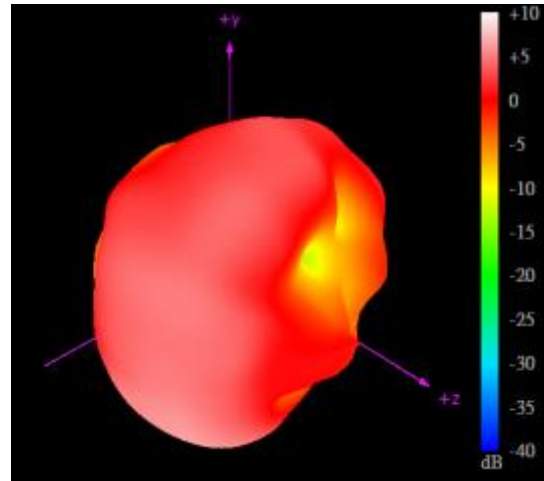

2500MHz

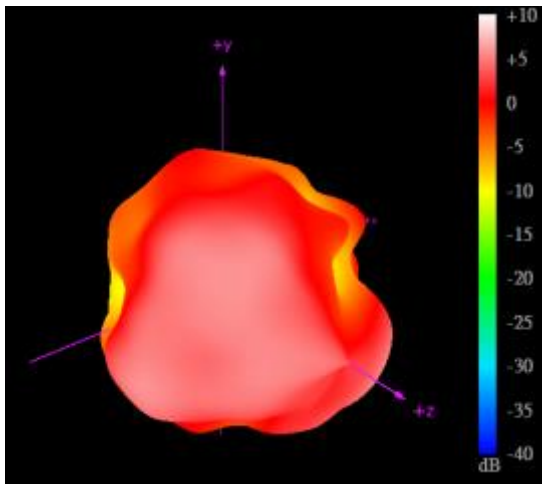

5150MHz

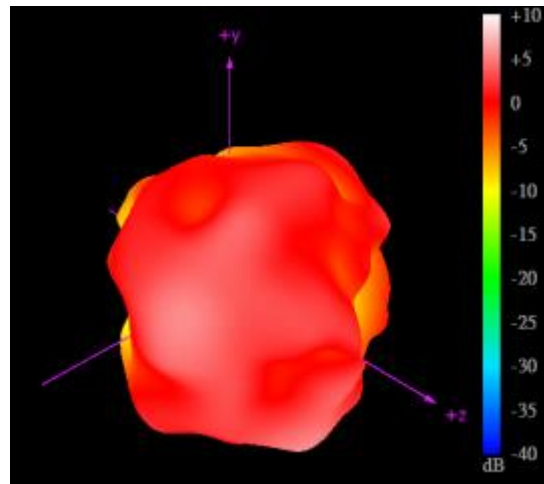

5850MHz

### 4.2.2. 2.4/5.8GHz MIMO2 3D Radiation Pattern

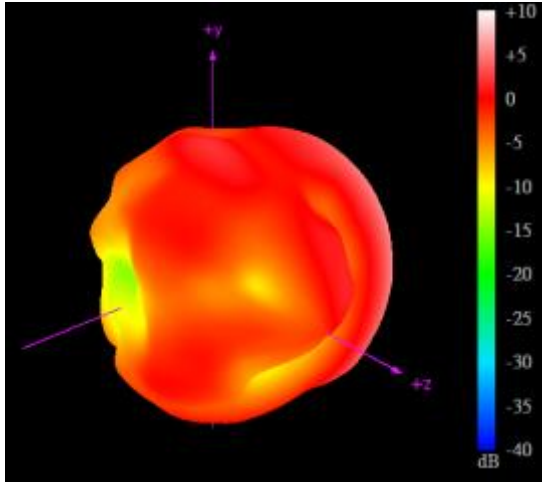

2400MHz

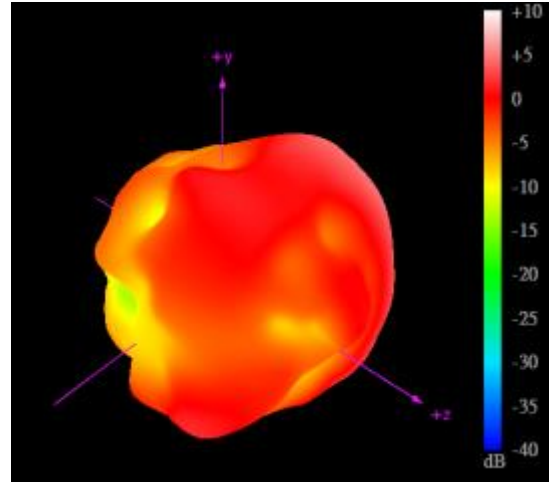

2500MHz

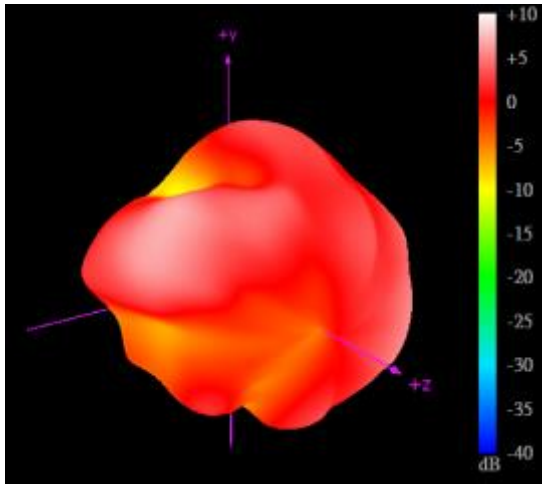

5150MHz

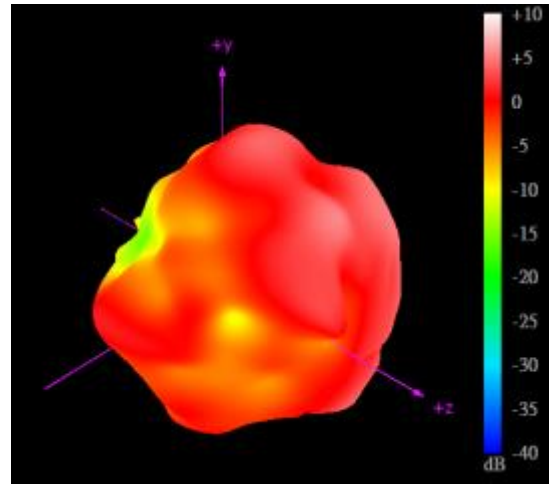

5850MHz

## 5. GPS/GLONASS

### 5.1. Block Diagram

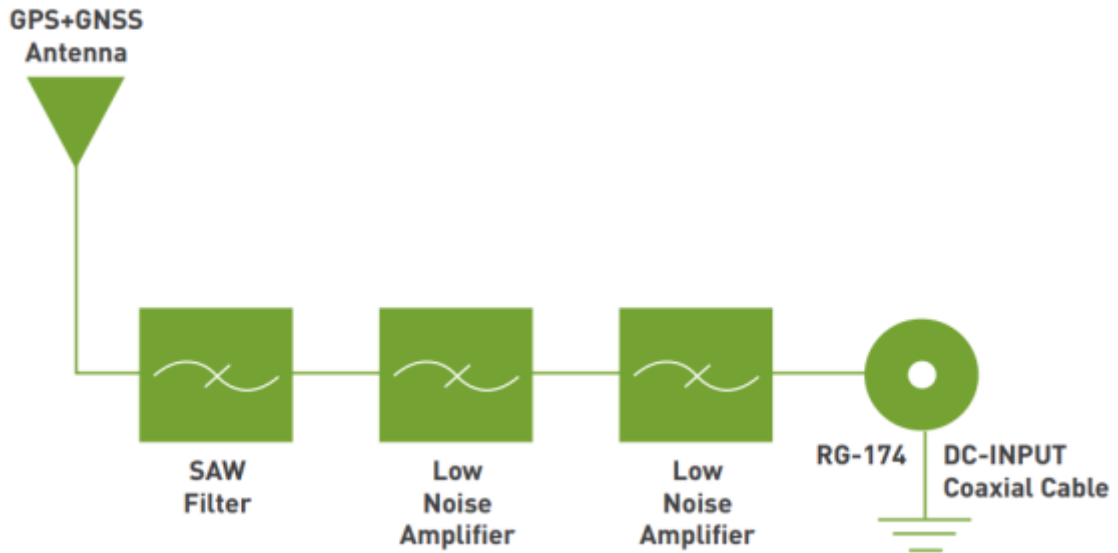

### 5.2. Smith Chart

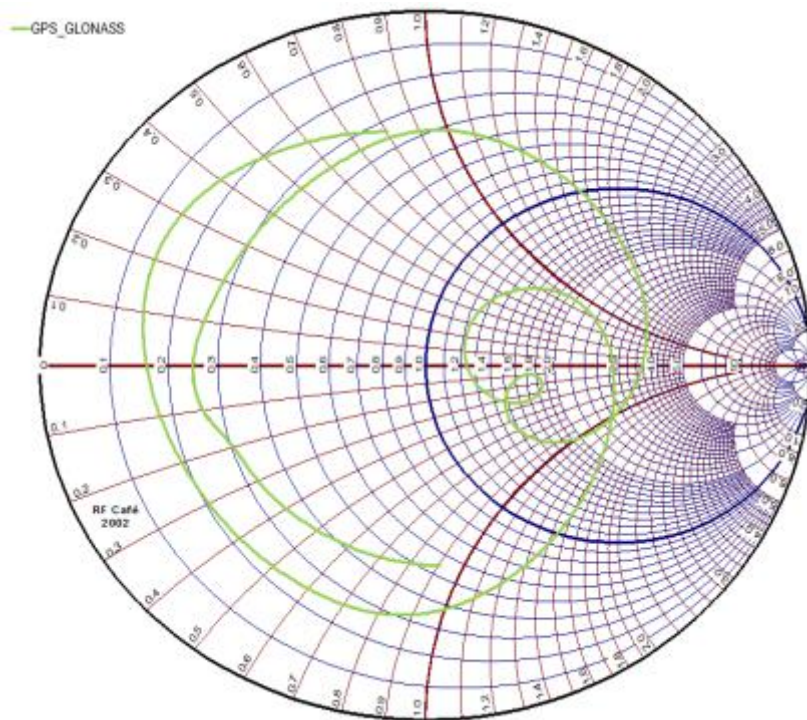

### 5.3. Return Loss

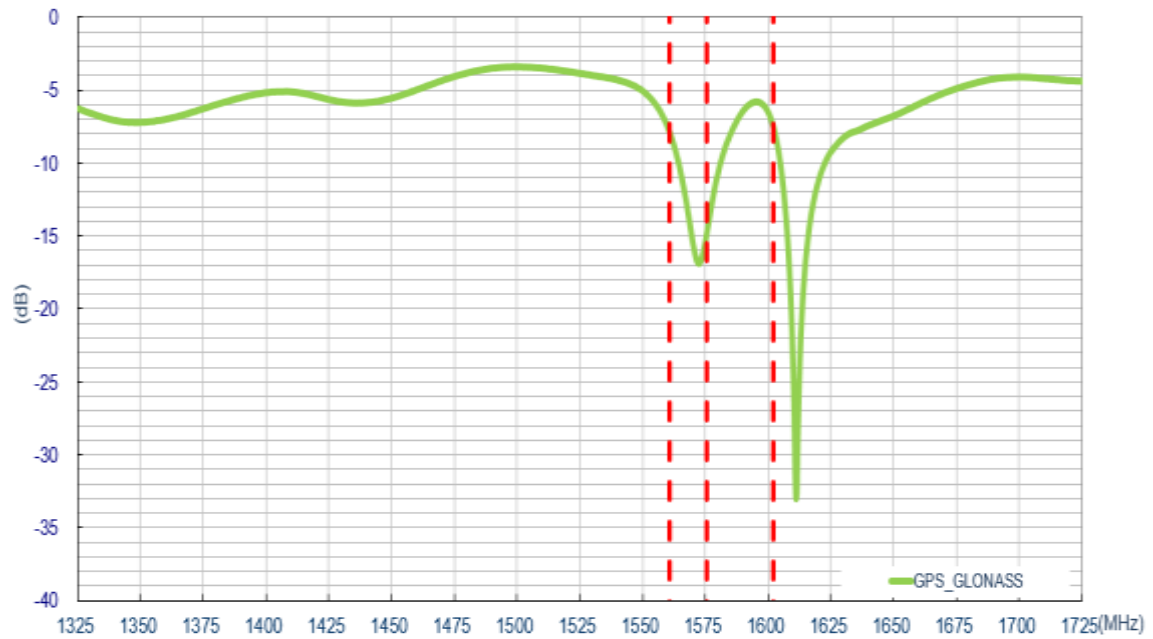

### 5.4. VSWR

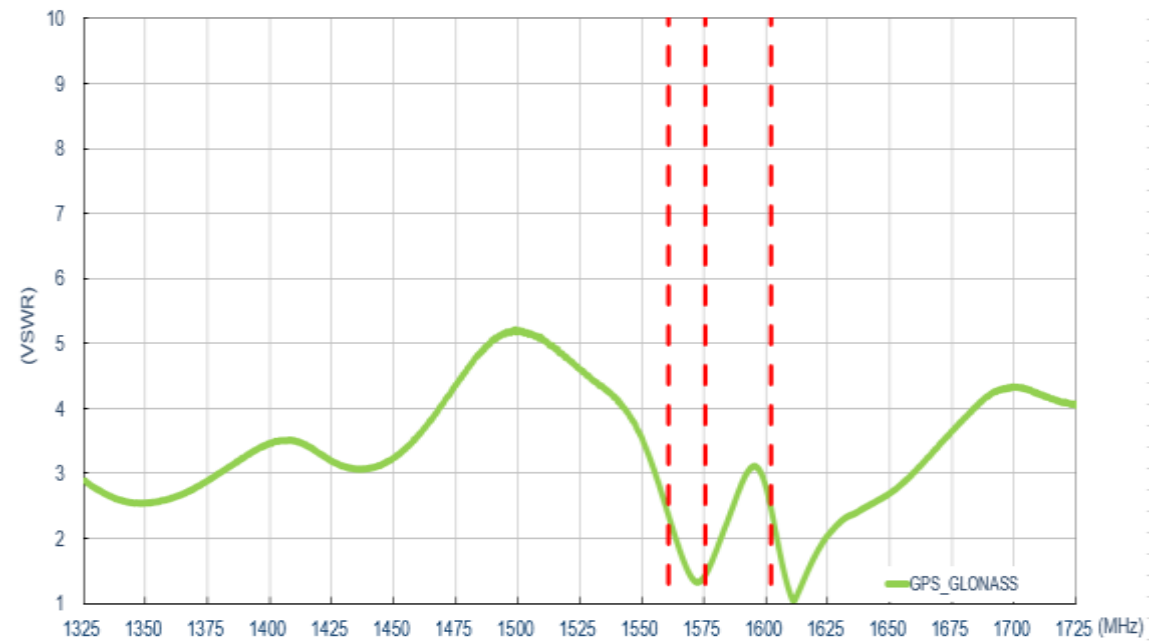

### 5.5. Efficiency

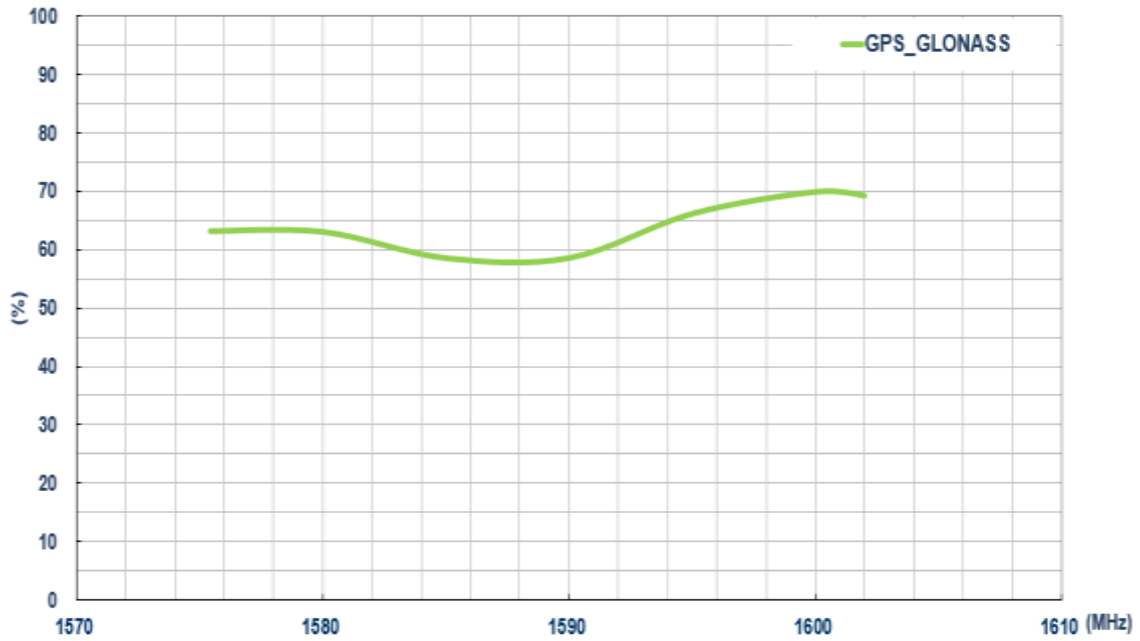

### 5.6. Average Gain

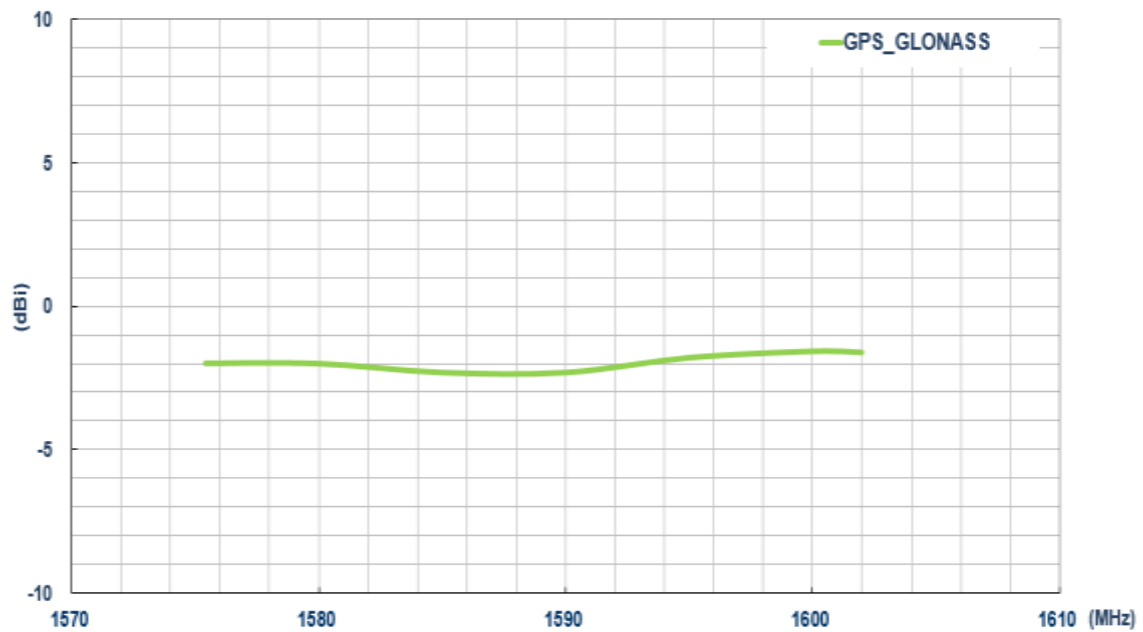

## 5.7. Peak Gain

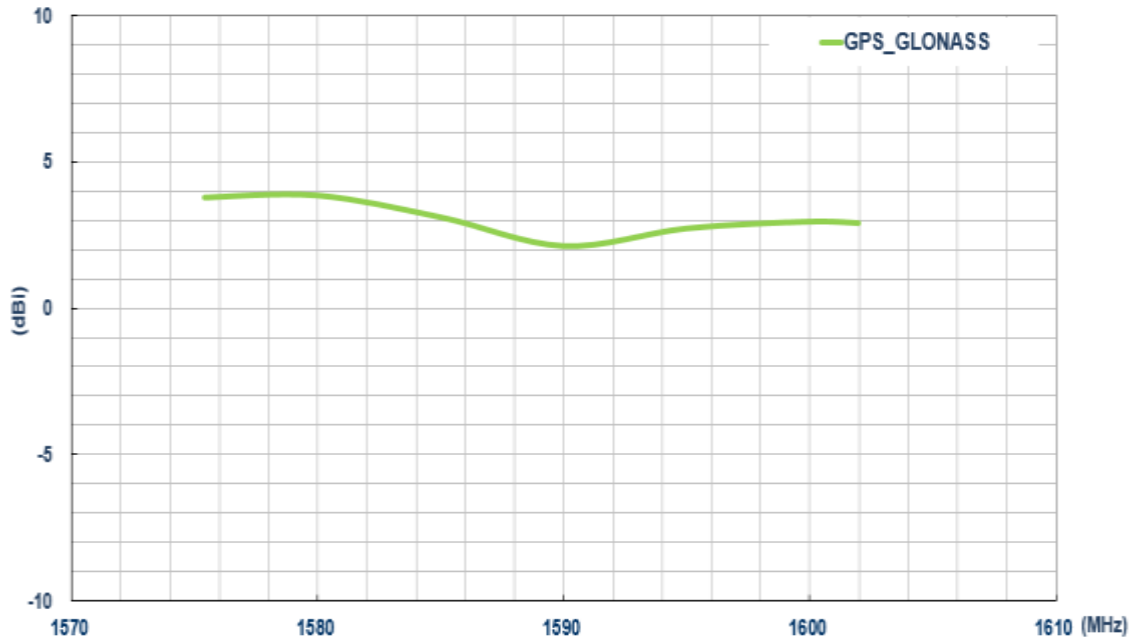

## 5.8. 2D Radiation Pattern

XY Plane

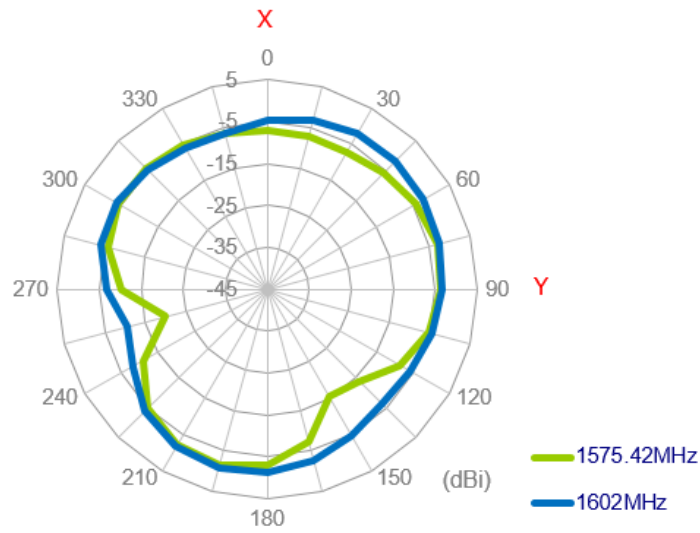

XZ Plane

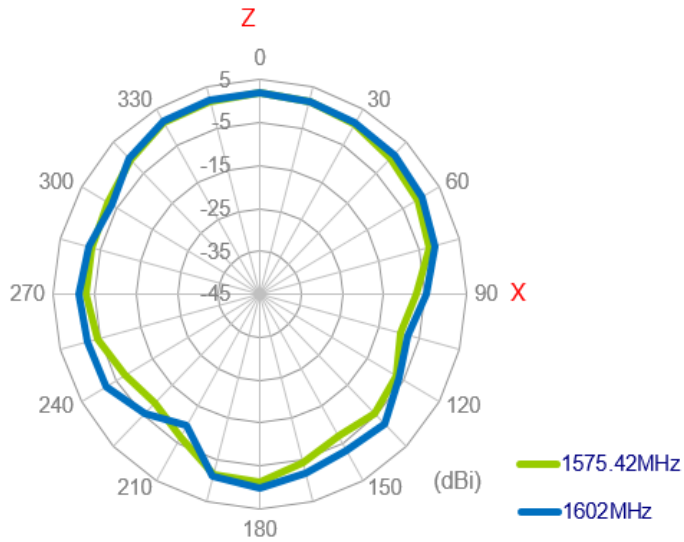

YZ Plane

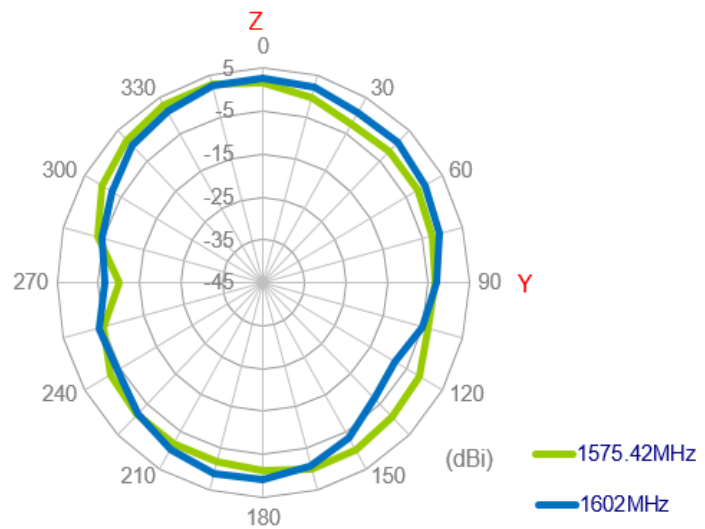

### 5.9. 3D Radiation Pattern

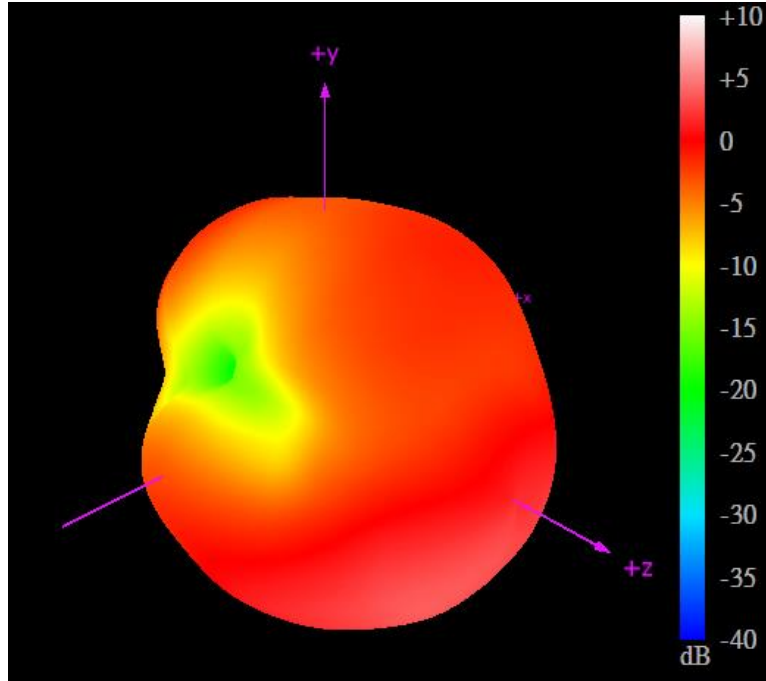

1575.42MHz

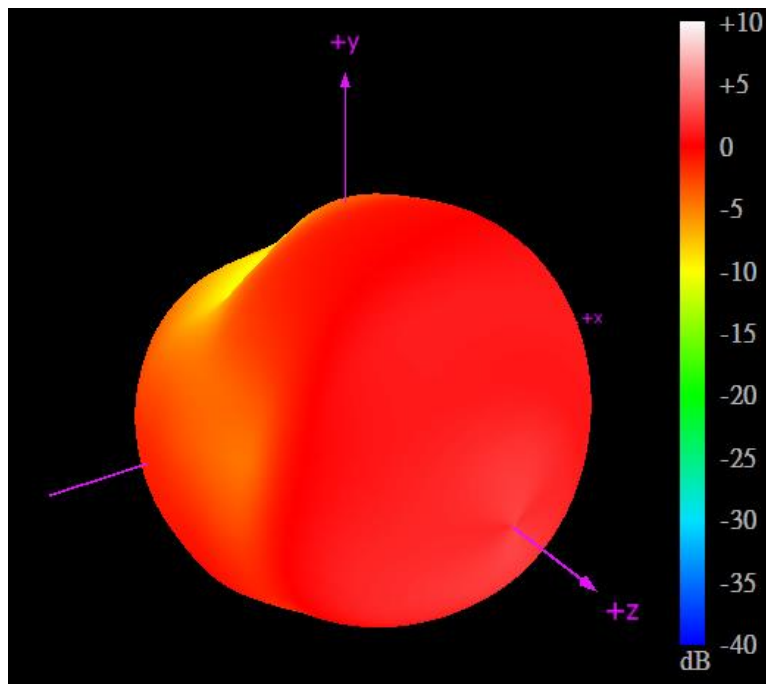

1602MHz



### 5.10. Out-of-Band Rejection

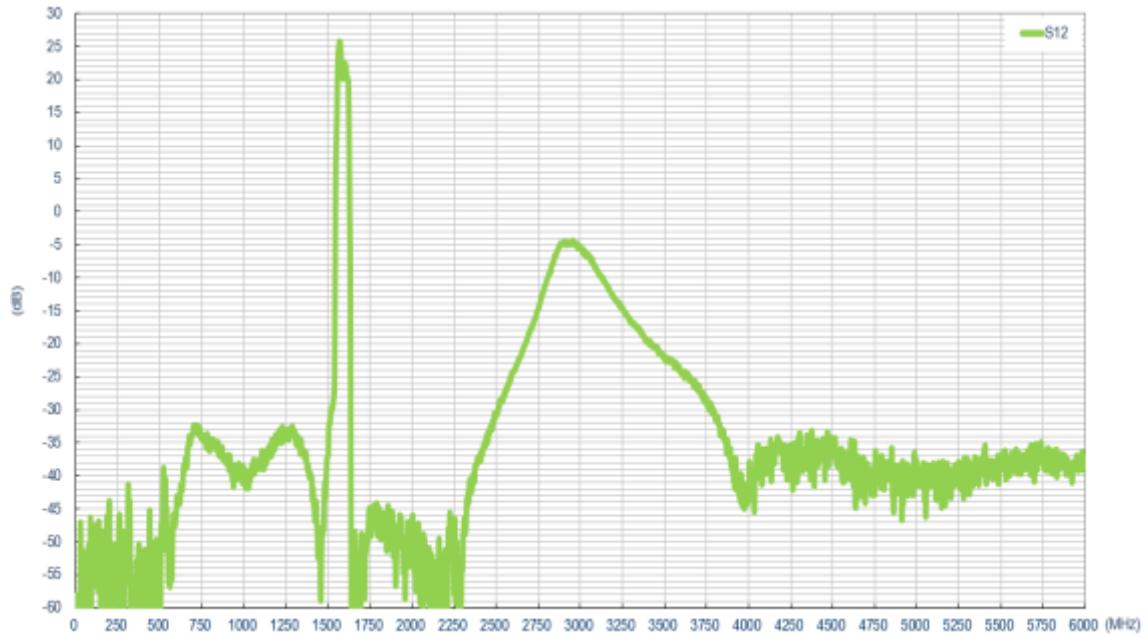

### 5.11. LNA Noise Figure and Gain

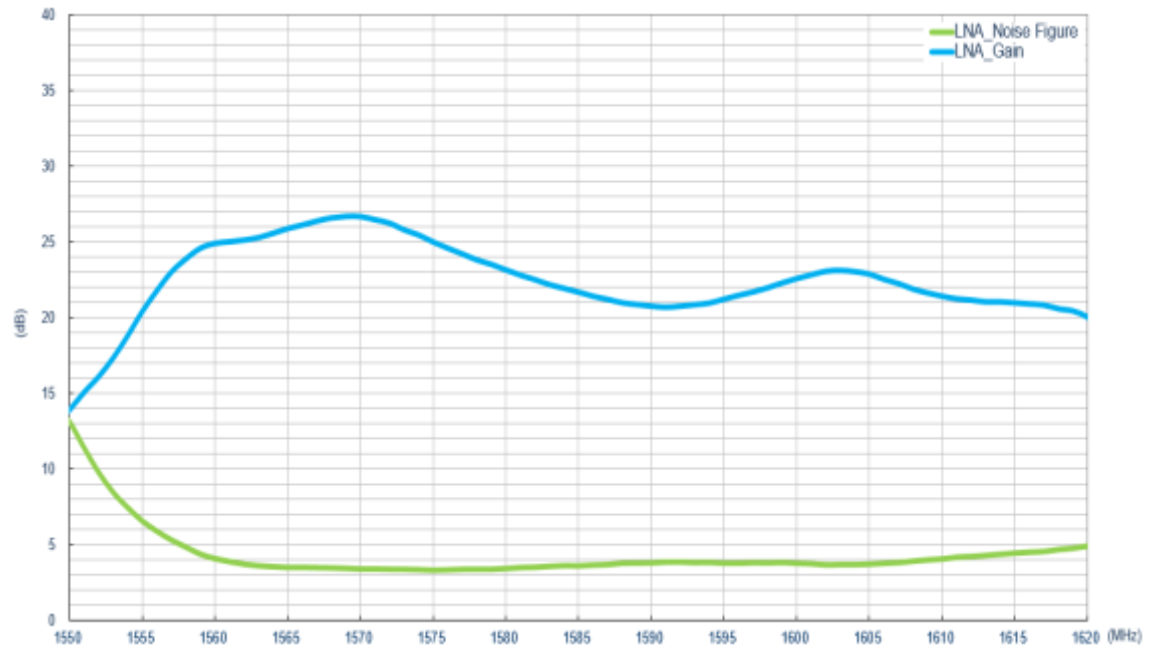

## 6. Installation

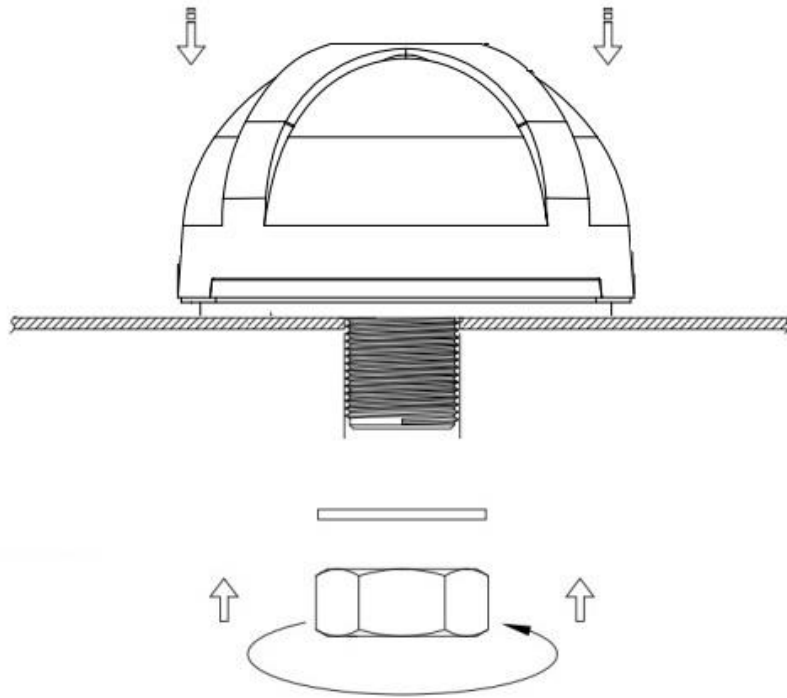

Recommended Torque for Mounting 49 N·m  
 Maximum Torque for Mounting 58.8 N·m

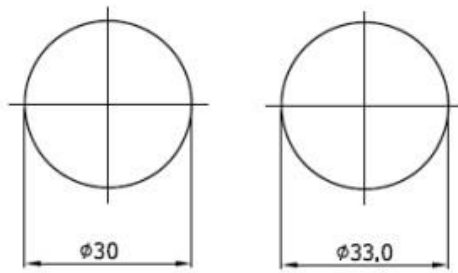

**Thread  
 Diameter**

**Recommended  
 Mounting Hole**

**Unit: mm**

## 7. Mechanical Drawing

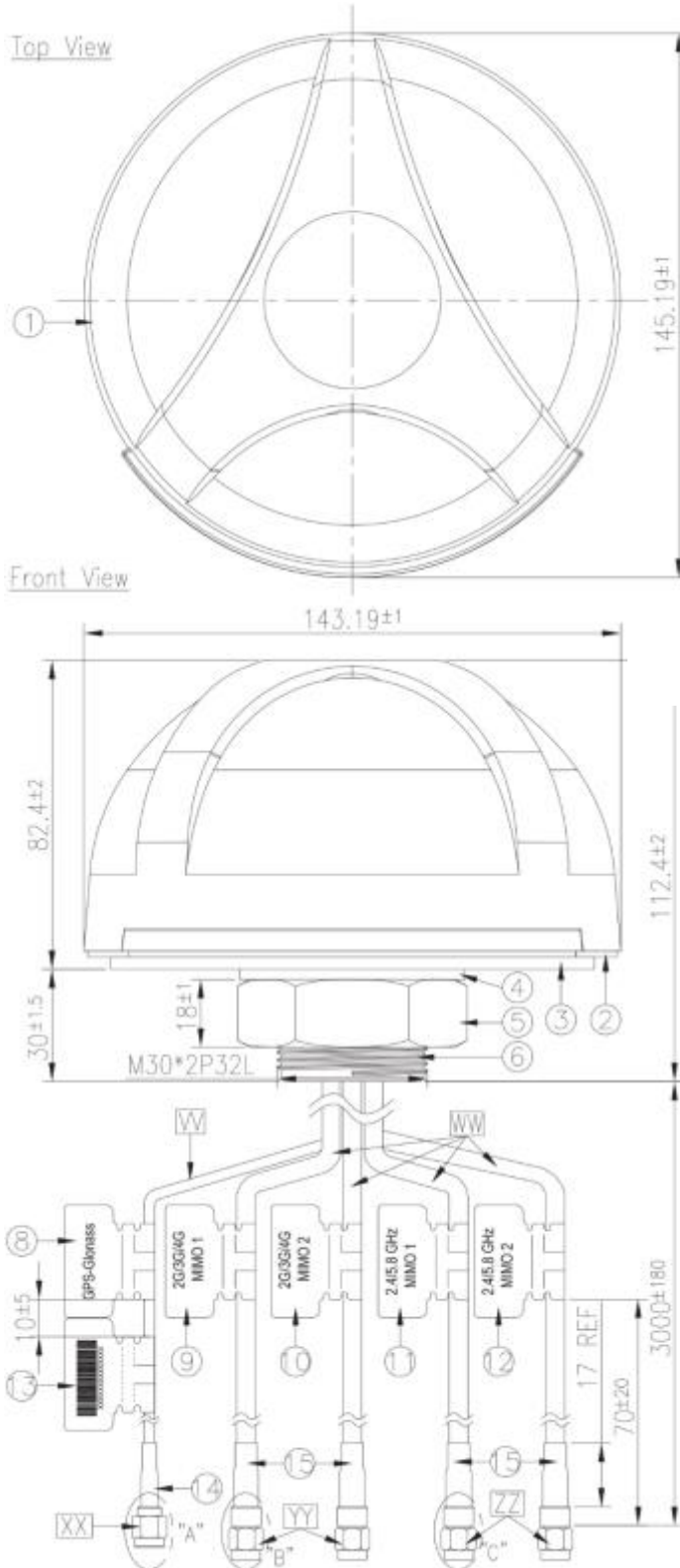

	Name	Material	Finish	QTY
1	Housing	PC	Black	1
2	Waterproof Rubber	Silicone Rubber	Black	1
3	Double Sided Adhesive(Black Foam)	3M9448H+CR1305	White Liner	1
4	Washer M30	Steel	Ni Plated	1
5	M30 Nut	Steel	Ni Plated	1
6	M30x2P Thread 32L	Zinc Alloy	Ni Plated	1
7	Rubber Stopper	Silicone Rubber	Black	1
8	GPS-Glossas Label	PEPA	Orange	1
9	2G/3G/4G MIMO1	PEPA	Gray	1
10	2G/3G/4G MIMO2	PEPA	White	1
11	2.4/5.8 GHz MIMO1 Label	PEPA	Yellow Black	1
12	2.4/5.8 GHz MIMO2 Label	PEPA	Red	1
13	Barcode Label	PEPA	White	1
14	Heat Shrink Tube	PE	Black	1
15	Heat Shrink Tube	PE	Black	4

	Name	Spec	Finish	QTY
W	Cable Type	RG174	Black	1
WW	Cable Type	CFD000	Black	4
XX	Connector Type(RG174)	SMA(M)ST	Au Plated	1
YY	Connector Type(CFD000)	SMA(M)ST	Au Plated	2
ZZ	Connector Type(CFD000)	RP-SMA(M)ST	Au Plated	2

## 8. Packaging

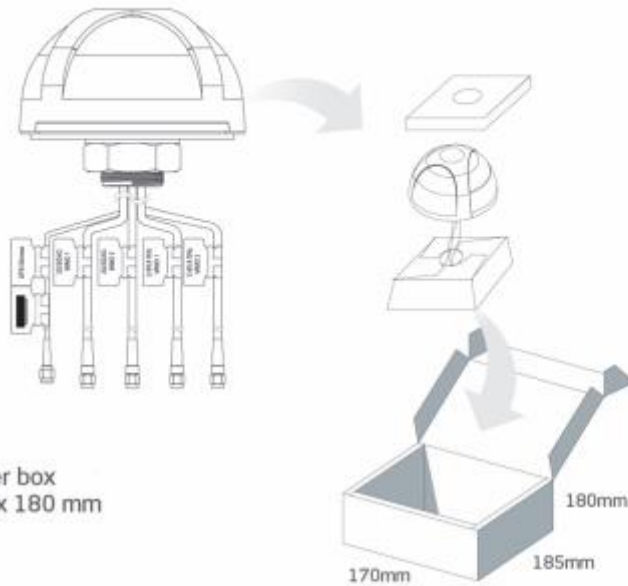

8 pcs MA752.B.ABICG.001 per carton  
Carton - 390 x 360 x 390mm  
Weight - 13.9Kg

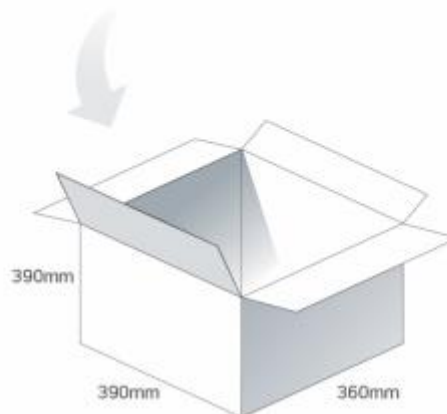

Pallet Dimensions 1200 x 1000 x 1370mm  
18 Cartons per Pallet  
6 Cartons per layer  
3 Layers

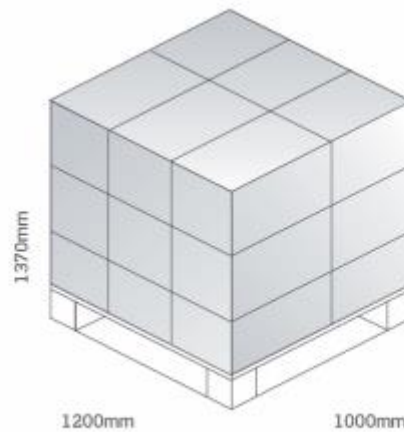

## 9. Application Note

### 9.1. LTE MIMO1 Antenna

#### 9.1.1. Return Loss

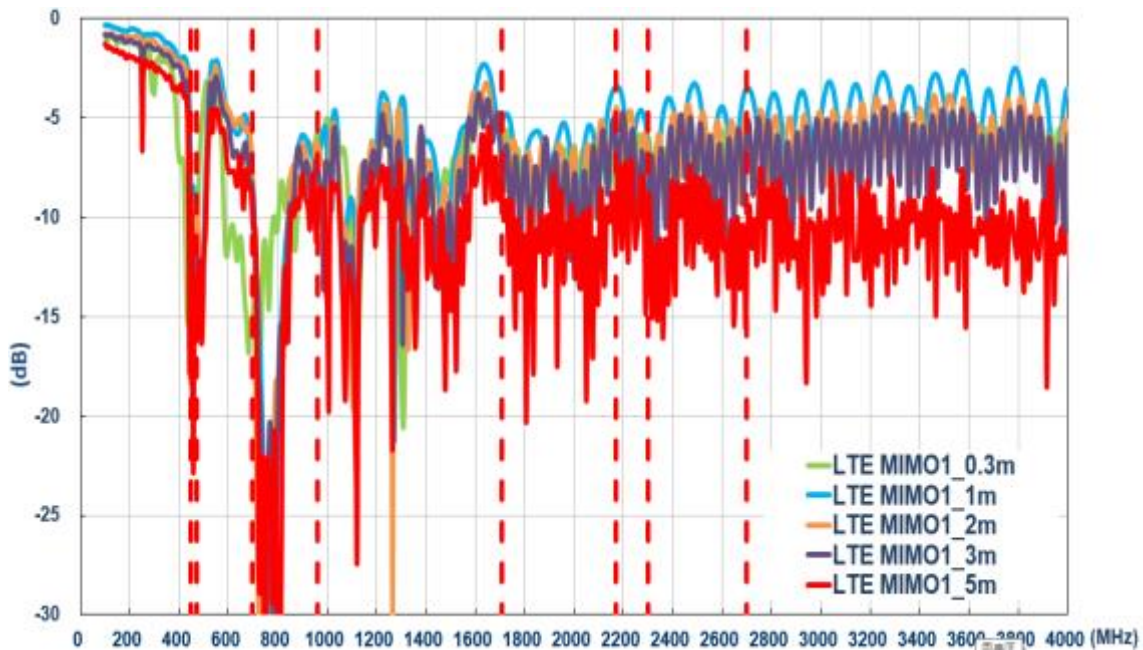

#### 9.1.2. Efficiency

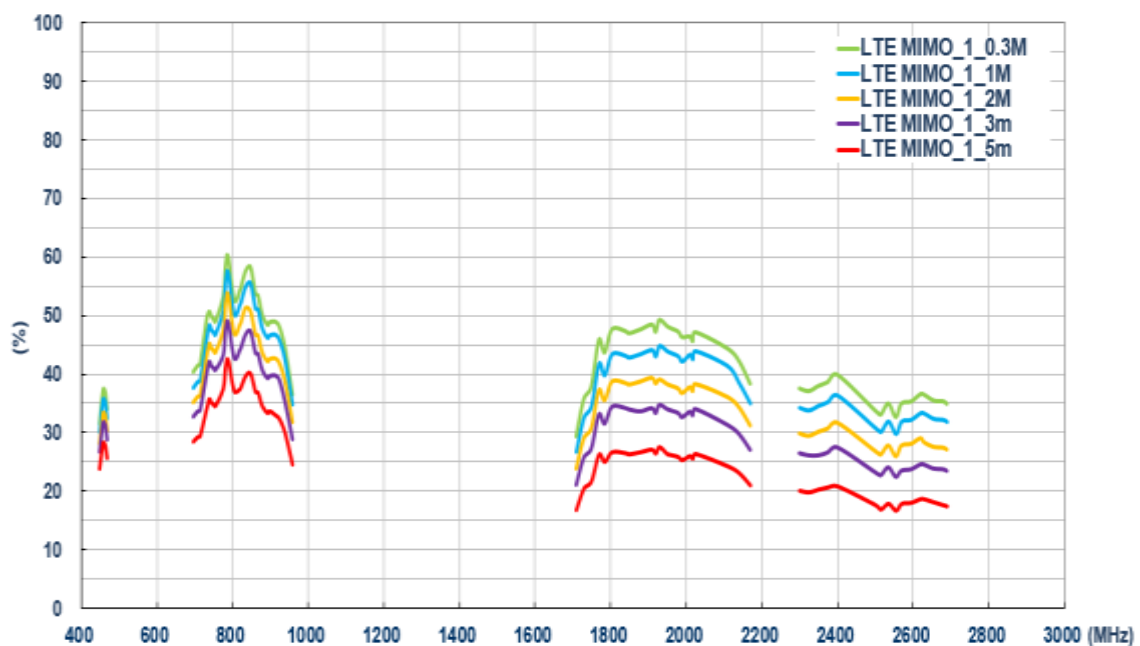

### 9.1.3. Average Gain

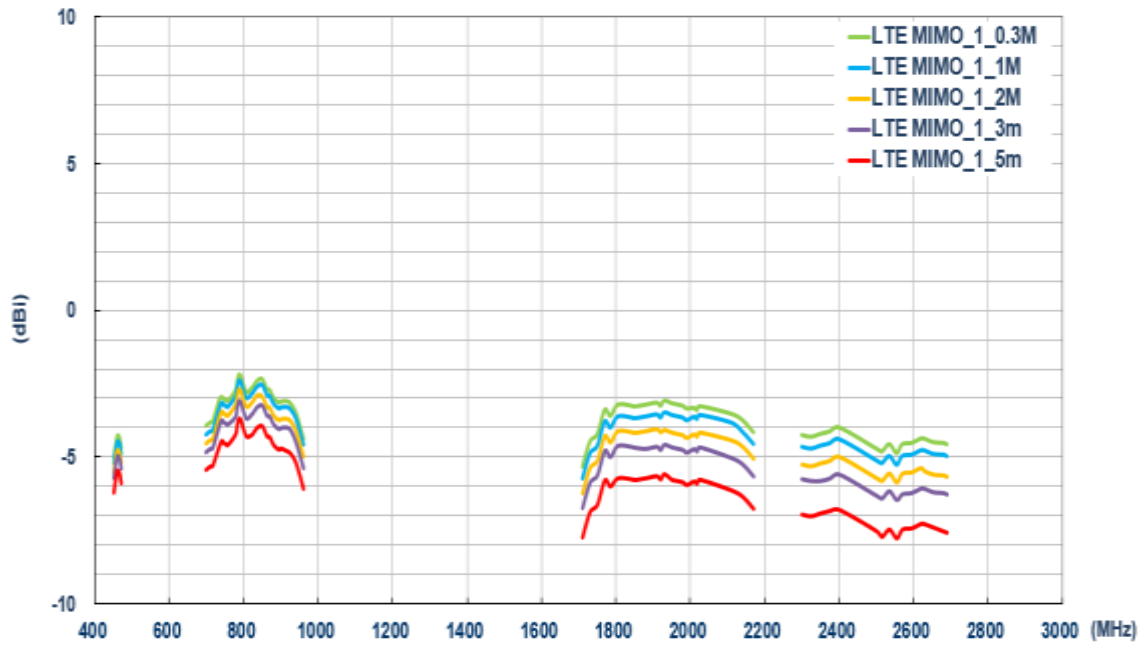

### 9.1.4. Peak Gain

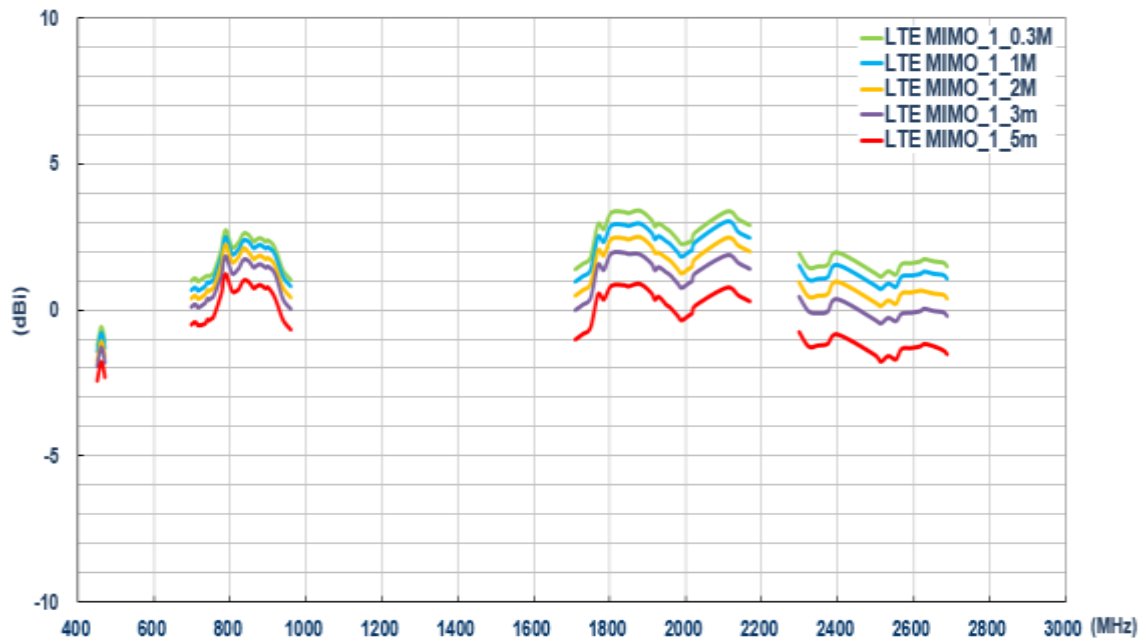

## 9.2. LTE MIMO2 Antenna

### 9.2.1. Return Loss

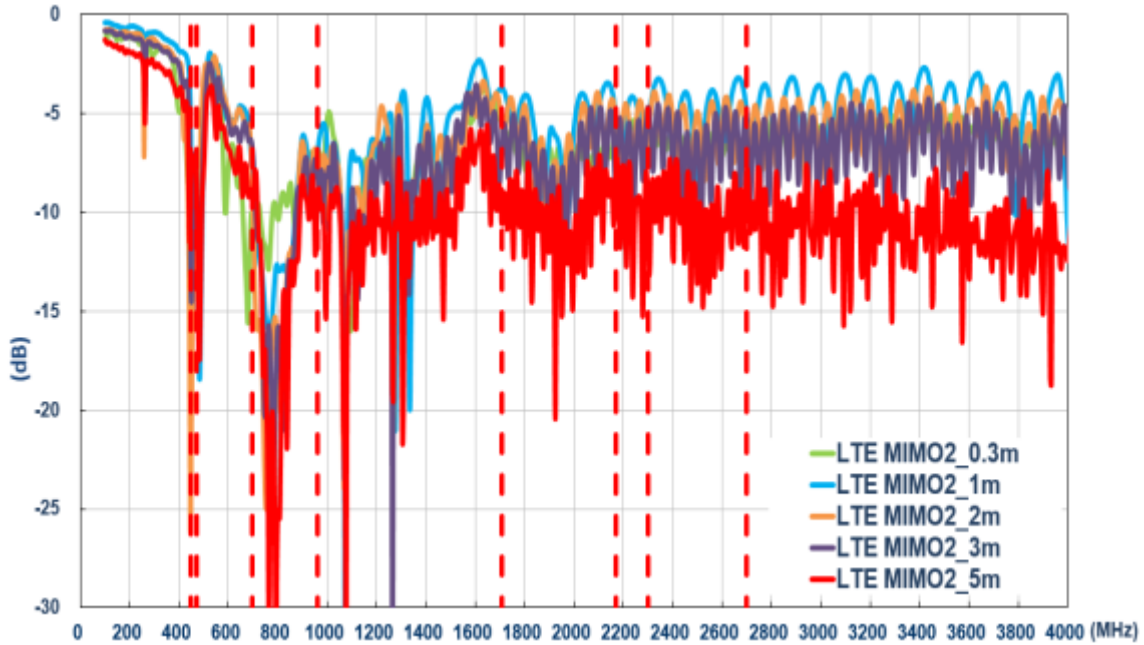

### 9.2.2. Efficiency

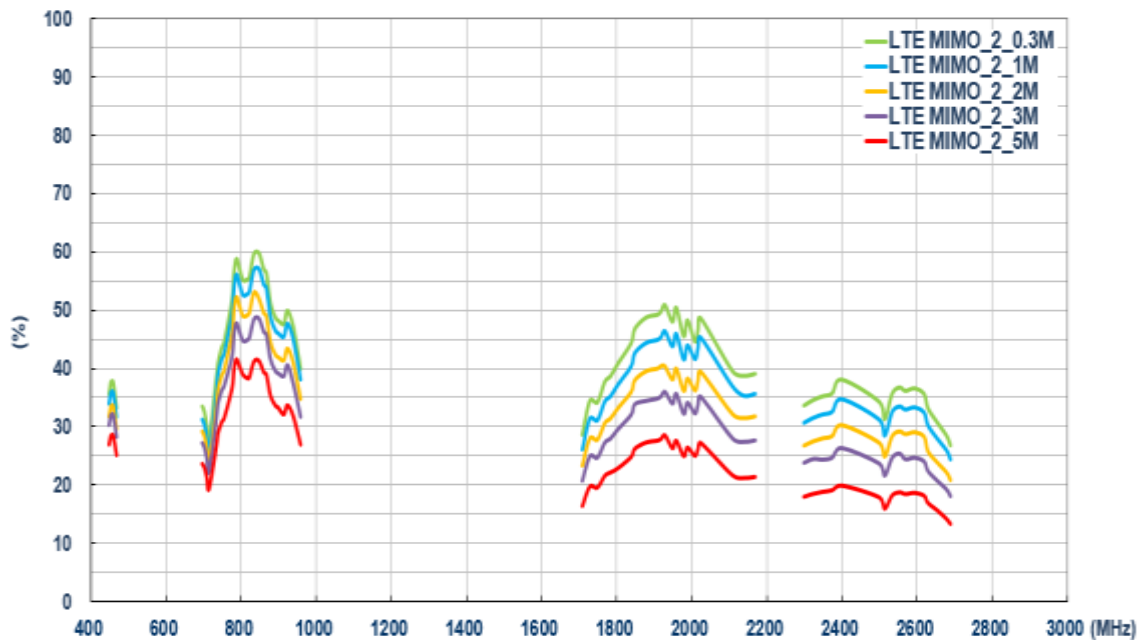

### 9.2.3. Average Gain

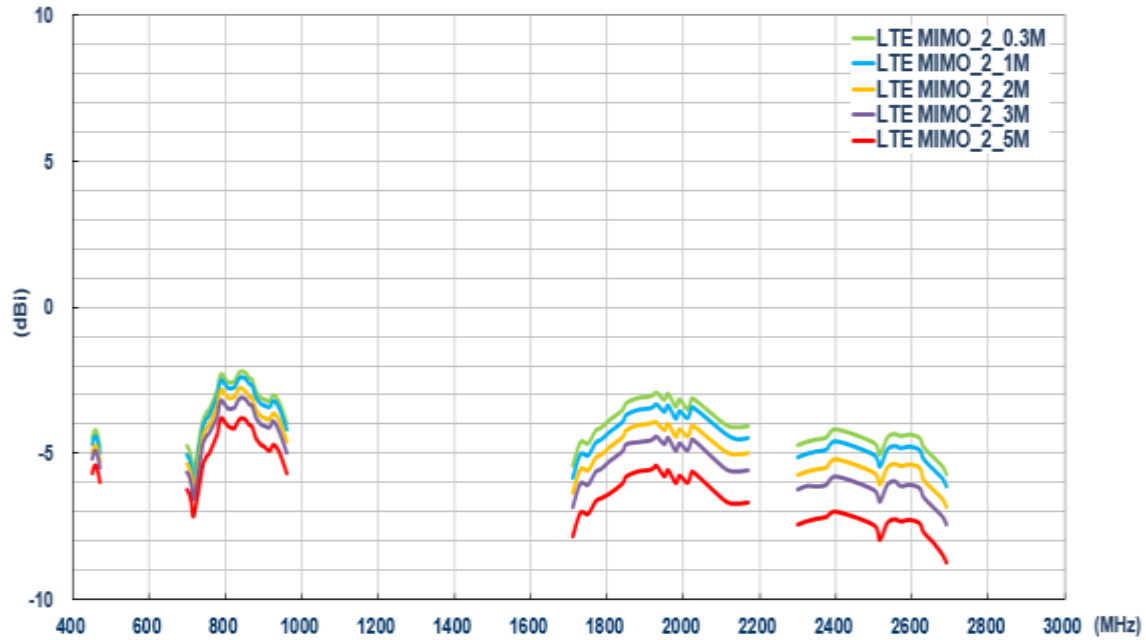

### 9.2.4. Peak Gain

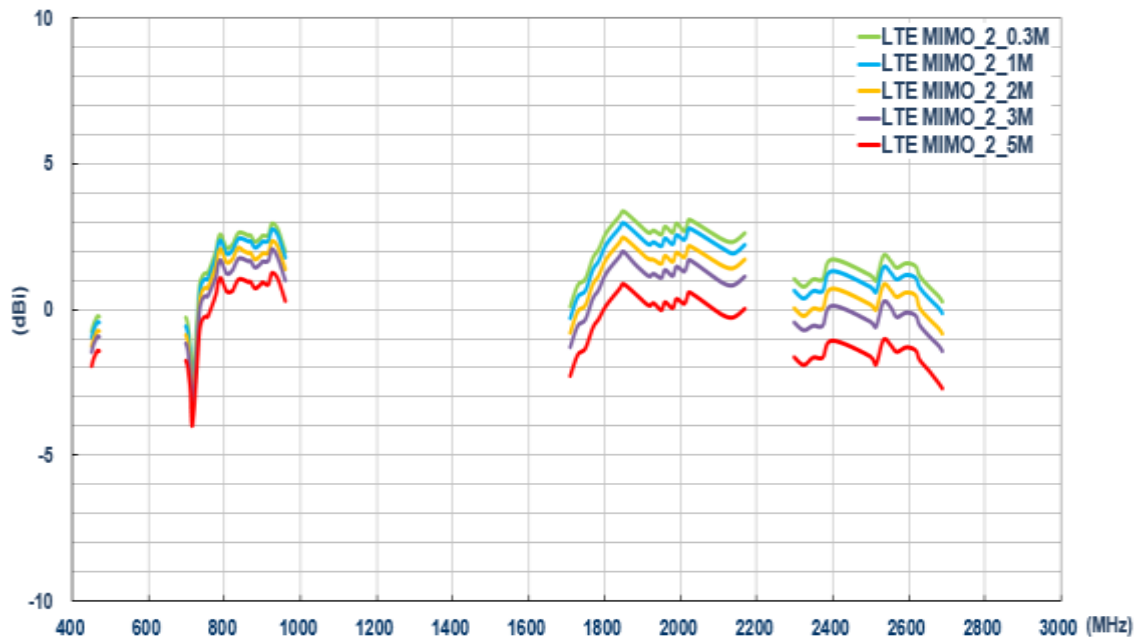



### 9.3. 2.4/5.8GHz MIMO1 Antenna

#### 9.3.1. Return Loss

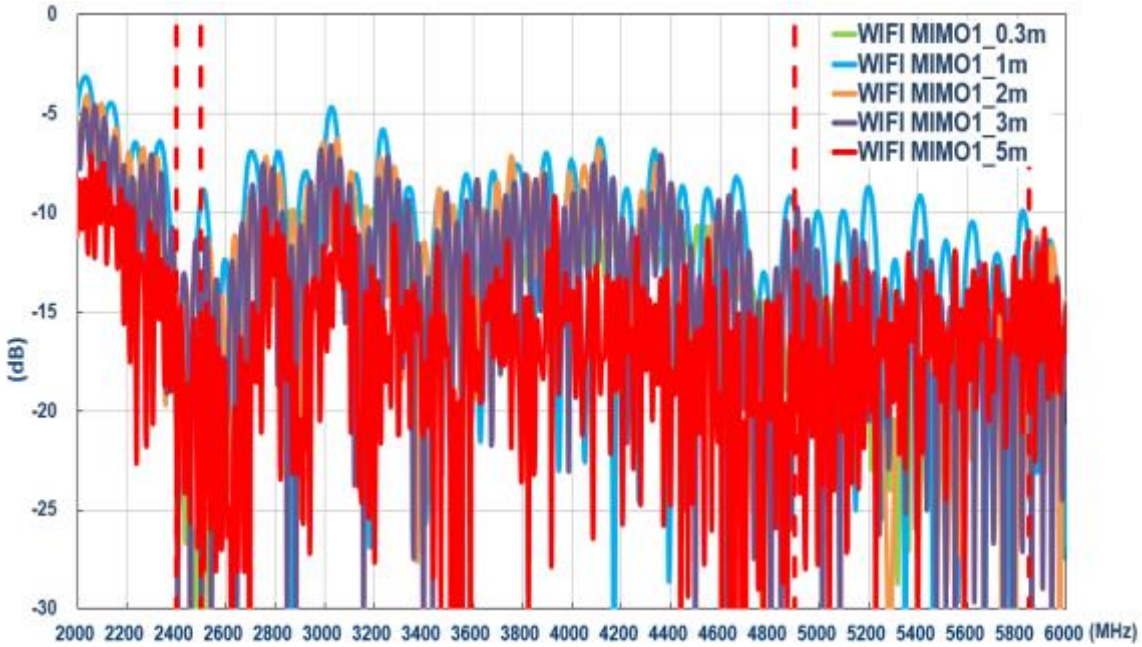

#### 9.3.2. Efficiency

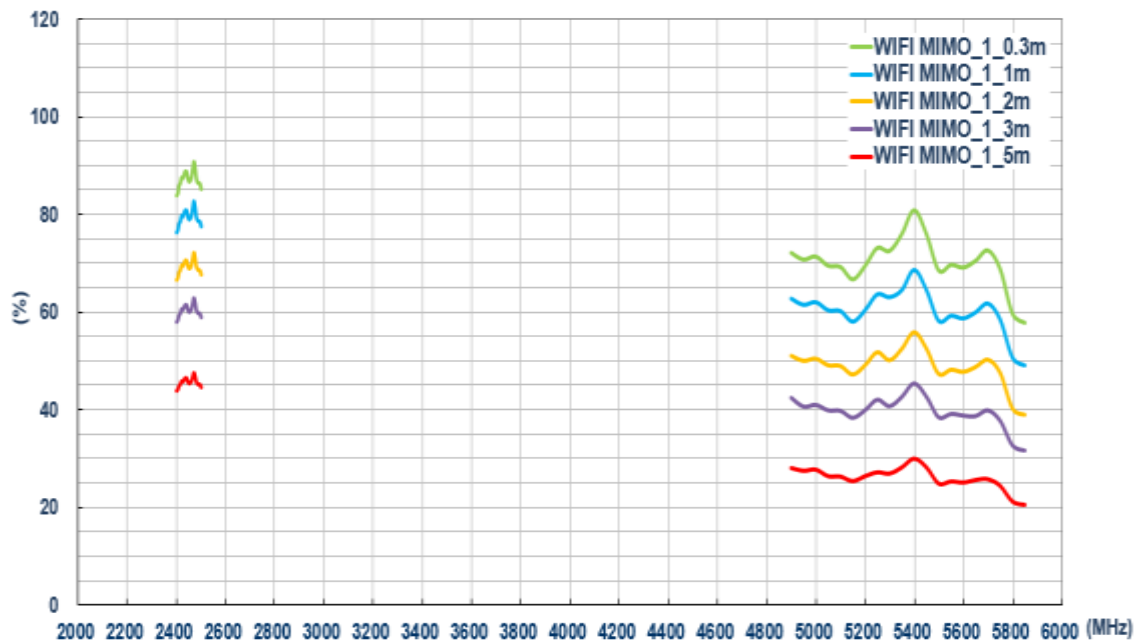

### 9.3.3. Average Gain

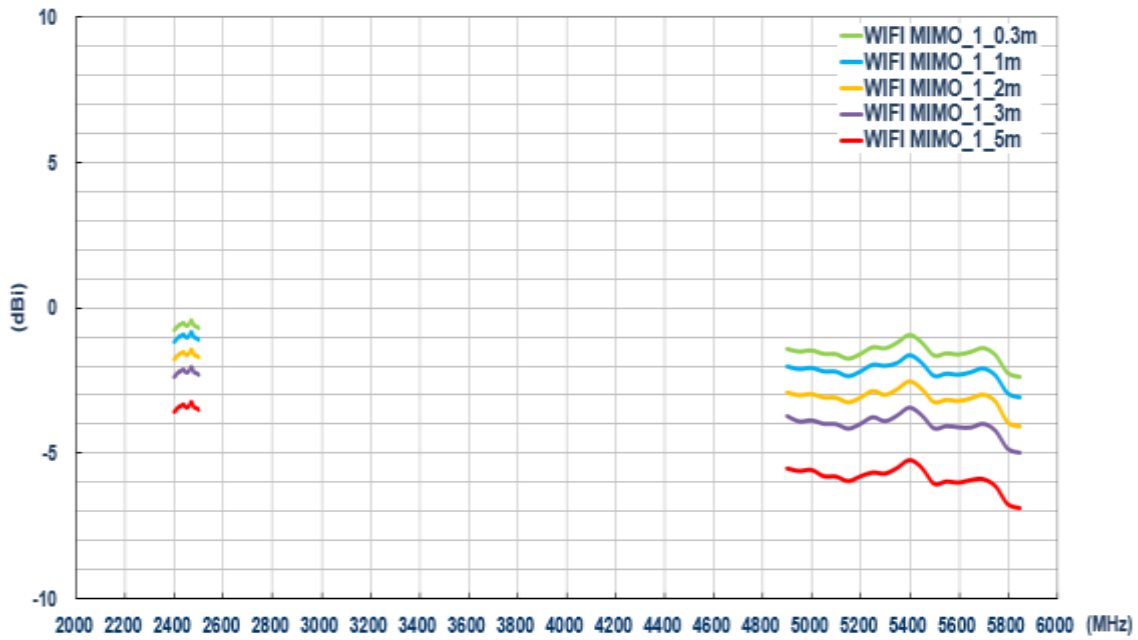

### 9.3.4. Peak Gain

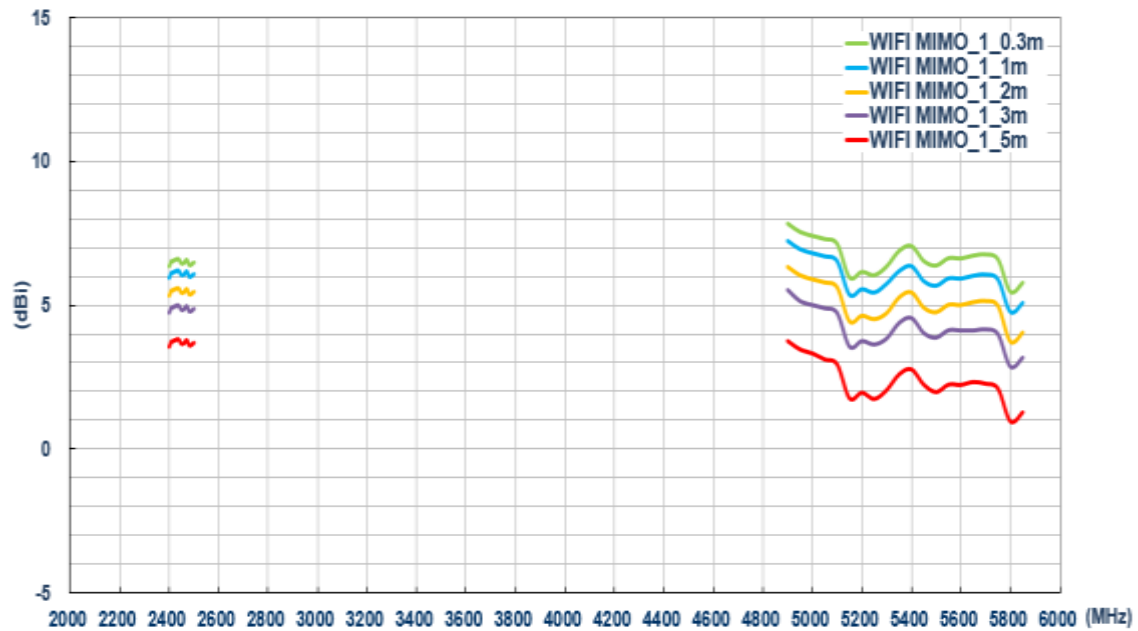

## 9.4. 2.4/5.8GHz MIMO2 Antenna

### 9.4.1. Return Loss

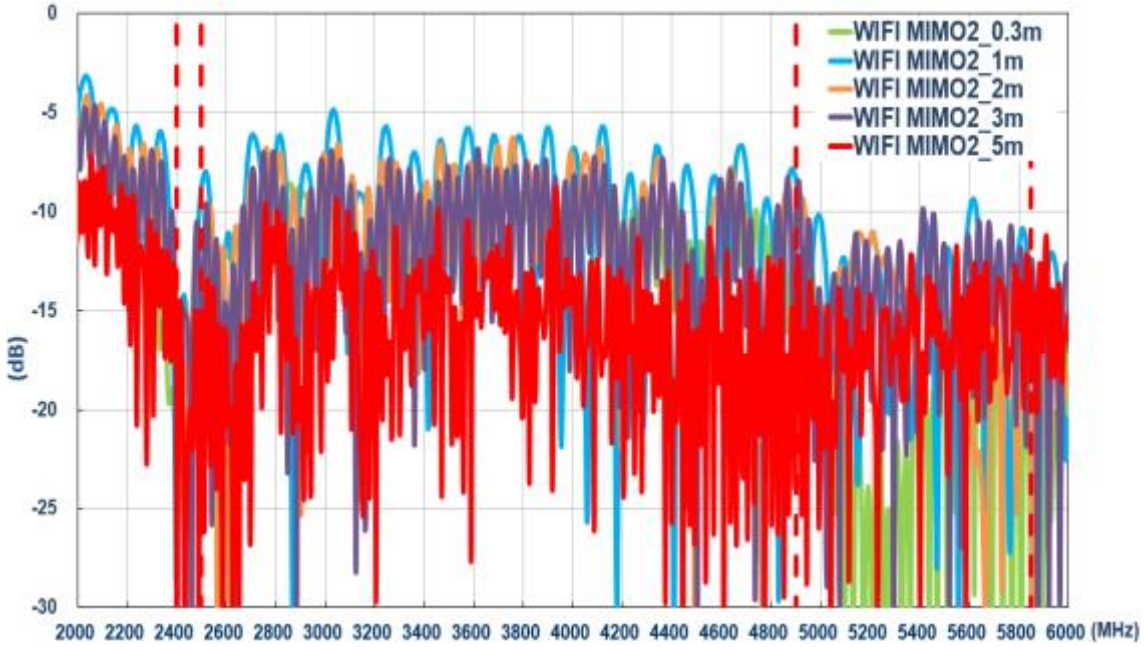

### 9.4.2. Efficiency

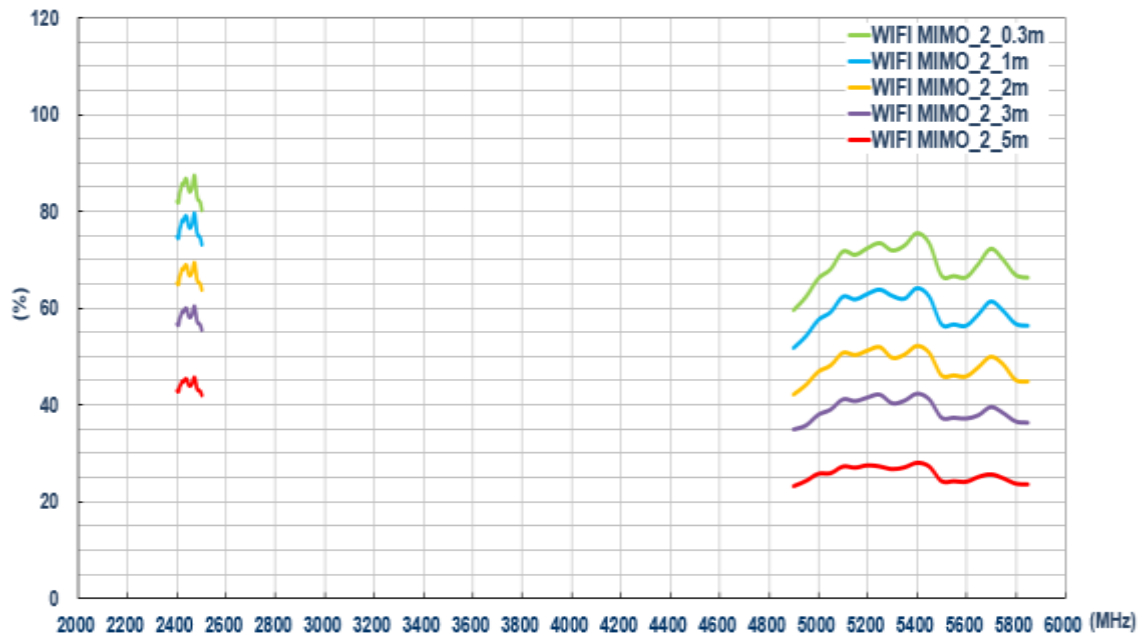

### 9.4.3. Average Gain

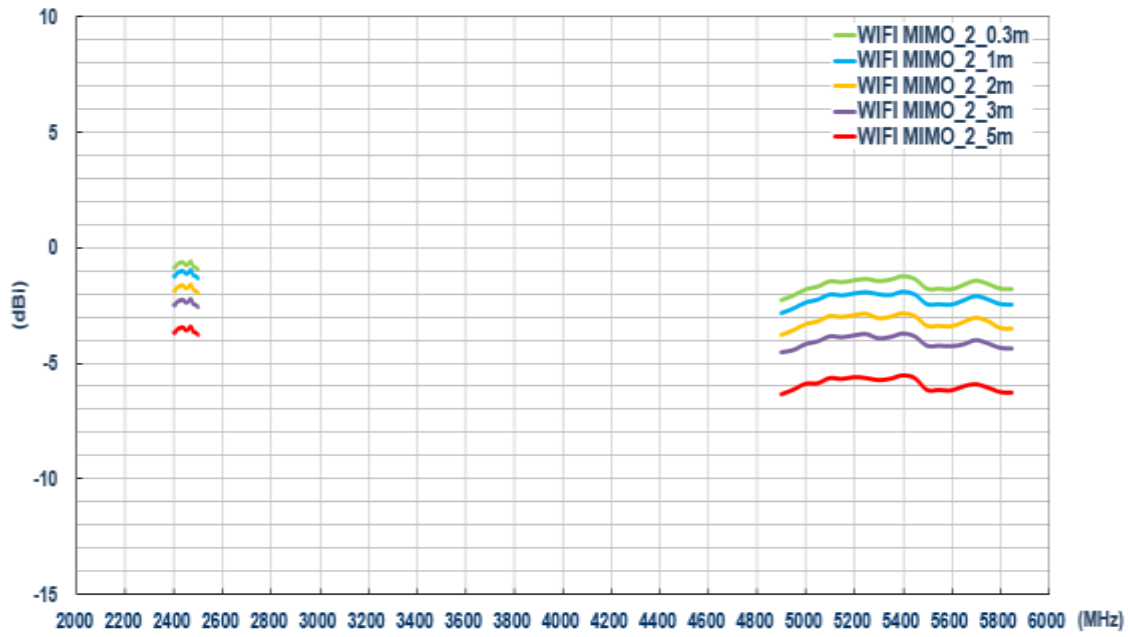

### 9.4.4. Peak Gain

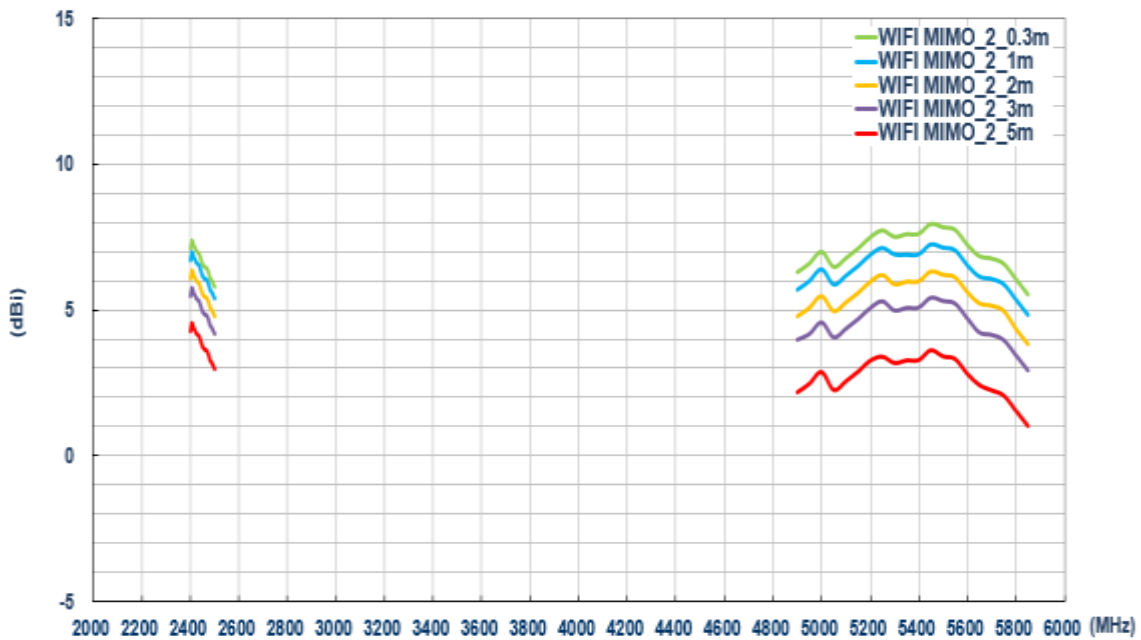

Taoglas makes no warranties based on the accuracy or completeness of the contents of this document and reserves the right to make changes to specifications and product descriptions at any time without notice. Taoglas reserves all rights to this document and the information contained herein.

Reproduction, use or disclosure to third parties without express permission is strictly prohibited.

Copyright © Taoglas Ltd.