

アキシャルリードインダクタ

AXIAL LEADED INDUCTORS

OPERATING TEMP	-25~+105°C (製品自己発熱を含む) (Including self-generated heat)
----------------	---



特長 FEATURES

- ・自動挿入に対し極めて高い信頼性を有するインダクタ
- ・自動化高速ラインによる生産の為、量産性に優れかつ高品質
- ・アキシャルリードタイプその他、ラジアルターピング、単品加工品がありバリエーションが豊富
- ・Extremely reliable inductors that are ideal for automatic insertion.
- ・Highly efficient automated production processes can provide high quality inductors in large volumes.
- ・Wide selection of configurations including axial leaded, formed radial leads and bulk products to meet most manufacturing needs.

用途 APPLICATIONS

- ・VTR、CTV、オーディオ、通信機、その他電子機器全般
- Consumer electronics such as VTRs, TVs, audio equipment, mobile communications, and general electronic appliances.

形名表記法 ORDERING CODE

1	3	4	5	6
形式	形状寸法(L×D)(mm以下)	リード加工形状(mm)	公称インダクタンス[μH]	インダクタンス許容差[%]
LA アキシャルインダクタ	02 3.4×2.3 (LAL/LAP) 3.6×2.4 (LAN)	KB フォーミング単品(04タイプ) KH フォーミング単品(03タイプ) KR フォーミング単品(02タイプ) NA ストレート単品 SK 縦形フォーミング TA アキシャルつづらターピング26.0幅 TB アキシャルつづらターピング52.0幅 VA 縦形ラジアルターピングピッチ2.5 VB 縦形ラジアルターピングピッチ5.0 VD ラジアルターピング	例 ※R=小数点 1R5 1.5 120 12	J ±5 K ±10 M ±20
2				7
製品区分				当社管理記号
L△ 一般 N△ 高電流タイプ P△ 一般(リード線径0.45φmm) △=スペース	03 7.0×2.7 04 9.8×4.0 05 14.0×5.5			△△△△ 標準品 △=スペース



1	3	4	5	6
Type	Body size(L×D)(mm)	Lead configurations(mm)	Nominal inductance[μH]	Inductance tolerance[%]
LA Axial inductor	02 3.4×2.3 (LAL/LAP) 3.6×2.4 (LAN)	KB Formed lead/bulk(04 type) KH Formed lead/bulk(03 type) KR Formed lead/bulk(02 type) NA Axial lead/bulk SK Formed lead(hair pin)/bulk(04 type) TA Axial lead(26mm lead space) /ammo pack(02/03 type) TB Axial lead(52mm lead space) /ammo pack(all types) VA Formed lead(hair pin) /ammo pack(02 type) VB Formed lead(hair pin) /ammo pack(03 type) VD Formed lead/ammo pack(02 type)	example ※R=decimal point 1R5 1.5 120 12	J ±5 K ±10 M ±20
2				7
Product Specification	03 7.0×2.7 04 9.8×4.0 05 14.0×5.5			Internal code
L△ Standard type N△ High current type P△ Standard type (lead diameter:0.45mm) △=Blank space				△△△△ Standard product △=Blank space

外形寸法 EXTERNAL DIMENSIONS

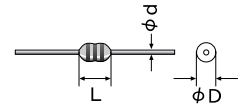

Type	Dimensions[mm](inch)			テーピング Taped		単品Bulk	
	L	φD	φd	ストレートStraight	フォーミングFormed	ストレートStraight	フォーミングFormed
LAL02	3.4max (0.134max)	2.3max (0.091max)	0.5±0.05 (0.020±0.002)	TB 	VD VA 	NA 	—
LAP02	3.4max (0.134max)	2.3max (0.091max)	0.45±0.05 (0.018±0.002)	TA 	—	—	KR
LAN02	3.6max (0.142max)	2.4max (0.094max)		—	—	—	—
LAL03	7.0max (0.276max)	2.6 ^{+0.1} _{-0.2} (0.102 ^{+0.004} _{-0.008})	※0.5±0.05 (0.020±0.002)	TA 	VB 	NA 	KH
LAL04	9.8max (0.386max)	4.0max (0.157max)	0.65±0.05 (0.026±0.002)	TB 	—	NA 	SK KB
LAL05	14.0max (0.551max)	5.5max (0.217max)	0.65±0.05 (0.026±0.002)	TB 	—	—	—

※VB : 0.6±0.05
(0.024±0.002)

Unit : mm (inch)

概略バリエーション AVAILABLE INDUCTANCE RANGE



代表値 Examples	Inductance	Imax [mA]	Rdcmax [Ω]	Imax [mA]	Rdcmax [Ω]	Imax [mA]	Rdcmax [Ω]	Imax [mA]	Rdcmax [Ω]	Imax [mA]	Rdcmax [Ω]
1μH	270	0.8	500	0.32	270	0.8	920	0.19	—	—	
10μH	160	2.5	280	1.0	160	2.5	500	0.58	—	—	
100μH	44	12	120	5.6	90	7.0	275	1.8	370	0.55	
1000μH	—	—	—	—	40	33.0	100	14.0	—	—	

セレクトショングイド
Selection Guide

アイテム一覧
Part Numbers

特性図
Electrical Characteristics

梱包
Packaging

信頼性
Reliability Data

使用上の注意
Precautions



etc

LAL/LAP02

形名 Ordering code	公称 インダクタンス Inductance [μH]	インダクタンス 許容差 Inductance Tolerance	Q (min.)	測定 周波数 Measuring frequency (MHz)	自己共振 周波数 Self-resonant frequency (MHz) (min.)	直流抵抗 DC Resistance [Ω] (max.)	定格電流 Rated current (mA) (max.)	
LA□02○R22K	0.22	±10%	35.0	25.2	450.0	0.40	400.0	
LA□02○R27K	0.27				410.0	0.43	380.0	
LA□02○R33K	0.33				360.0	0.48	370.0	
LA□02○R39K	0.39				300.0	0.51	350.0	
LA□02○R47K	0.47				230.0	0.56	330.0	
LA□02○R56K	0.56				210.0	0.61	320.0	
LA□02○R68K	0.68				190.0	0.67	310.0	
LA□02○R82K	0.82				170.0	0.74	290.0	
LA□02○1R0K	1.0				150.0	0.80	270.0	
LA□02○1R2K	1.2				110.0	0.9	260.0	
LA□02○1R5K	1.5				80.0	1.0	250.0	
LA□02○1R8K	1.8				60.0	1.1	240.0	
LA□02○2R2K	2.2				45.0	1.2	230.0	
LA□02○2R7K	2.7				40.0	1.3	220.0	
LA□02○3R3K	3.3				38.0	1.4	210.0	
LA□02○3R9K	3.9				35.0	1.6	200.0	
LA□02○4R7K	4.7				32.0	1.7	190.0	
LA□02○5R6K	5.6				30.0	1.9	180.0	
LA□02○6R8K	6.8		28.0	2.0	175.0			
LA□02○8R2K	8.2		26.0	2.2	165.0			
LA□02○100K	10.0		24.0	2.5	160.0			
LA□02○120K	12.0		22.0	2.5	150.0			
LA□02○150K	15.0		20.0	2.8	145.0			
LA□02○180K	18.0		18.0	3.1	140.0			
LA□02○220K	22.0		17.0	3.4	130.0			
LA□02○270K	27.0		16.0	4.3	80.0			
LA□02○330K	33.0		14.0	4.7	76.0			
LA□02○390K	39.0		13.0	5.2	74.0			
LA□02○470K	47.0		12.0	5.8	70.0			
LA□02○560K	56.0		11.0	6.4	68.0			
LA□02○680K	68.0		10.0	7.2	64.0			
LA□02○820K	82.0		9.5	11.0	46.0			
LA□02○101K	100.0		9.0	12.0	44.0			
LA□02○121K	120.0	8.0	13.0	42.0				
LA□02○151K	150.0	6.0	16.0	39.0				
LA□02○181K	180.0	5.5	18.0	37.0				
LA□02○221K	220.0	5.0	20.0	35.0				
			40.0	7.96	22.0	2.5	150.0	
					2.52	20.0	2.8	145.0
						18.0	3.1	140.0
						17.0	3.4	130.0
						16.0	4.3	80.0
						14.0	4.7	76.0
			13.0	5.2		74.0		
			12.0	5.8	70.0			
			11.0	6.4	68.0			
			10.0	7.2	64.0			
			9.5	11.0	46.0			
			9.0	12.0	44.0			
			8.0	13.0	42.0			
			6.0	16.0	39.0			
			5.5	18.0	37.0			
			5.0	20.0	35.0			

形名の□には製品区分記号(リード線径)が入ります。(L:標準0.5mm, P:0.45mm)

形名の○にはリード加工形状記号が入ります。

□ Please specify the Product Specification(lead diameter)code. (L:standard 0.5mm or P:0.45mm)

○ Please specify the Lead configuration code.

LAN02

形名 Ordering code	公称 インダクタンス Inductance [μH]	インダクタンス 許容差 Inductance Tolerance	Q (min.)	測定 周波数 Measuring frequency [MHz]	自己共振 周波数 Self-resonant frequency [MHz] (min.)	直流抵抗 DC Resistance [Ω] (max.)	定格電流 Rated current [mA] (max.)
LAN02○R12K	0.12	±10%	50.0	25.2	500.0	0.12	850.0
LAN02○R15K	0.15				500.0	0.14	800.0
LAN02○R18K	0.18				500.0	0.15	760.0
LAN02○R22K	0.22				500.0	0.16	730.0
LAN02○R27K	0.27				500.0	0.18	690.0
LAN02○R33K	0.33				480.0	0.19	660.0
LAN02○R39K	0.39				430.0	0.21	640.0
LAN02○R47K	0.47				380.0	0.23	610.0
LAN02○R56K	0.56				350.0	0.25	580.0
LAN02○R68K	0.68				310.0	0.27	550.0
LAN02○R82K	0.82				270.0	0.29	520.0
LAN02○1R0J	1.0				±5 %	40.0	7.96
LAN02○1R2J	1.2	210.0	0.35	480.0			
LAN02○1R5J	1.5	190.0	0.38	450.0			
LAN02○1R8J	1.8	140.0	0.42	430.0			
LAN02○2R2J	2.2	90.0	0.47	410.0			
LAN02○2R7J	2.7	70.0	0.52	390.0			
LAN02○3R3J	3.3	50.0	0.57	370.0			
LAN02○3R9J	3.9	35.0	0.63	360.0			
LAN02○4R7J	4.7	32.0	0.69	340.0			
LAN02○5R6J	5.6	30.0	0.75	320.0			
LAN02○6R8J	6.8	28.0	0.84	310.0			
LAN02○8R2J	8.2	26.0	0.92	290.0			
LAN02○100J	10.0	24.0	1.0	280.0			
LAN02○120J	12.0	22.0	1.0	280.0			
LAN02○150J	15.0	20.0	1.2	265.0			
LAN02○180J	18.0	18.0	1.3	250.0			
LAN02○220J	22.0	17.0	1.5	235.0			
LAN02○270J	27.0	15.0	1.7	220.0			
LAN02○330J	33.0	14.0	2.2	180.0			
LAN02○390J	39.0	13.0	2.4	170.0			
LAN02○470J	47.0	12.0	2.8	160.0			
LAN02○560J	56.0	10.0	4.1	140.0			
LAN02○680J	68.0	9.2	4.5	130.0			
LAN02○820J	82.0	8.8	5.0	125.0			
LAN02○101J	100.0	8.0	5.6	120.0			
LAN02○121J	120.0	50.0	0.796	6.6	9.2	90.0	
LAN02○151J	150.0			5.8	10.5	85.0	
LAN02○181J	180.0			5.4	11.5	80.0	
LAN02○221J	220.0			4.8	13.0	75.0	
LAN02○271J	270.0			3.6	16.0	70.0	
LAN02○331J	330.0			3.4	18.0	66.0	
LAN02○391J	390.0			3.2	20.0	63.0	
LAN02○471J	470.0			3.0	22.0	60.0	

形名の○にはリード加工形状記号が入ります。
○ Please specify the Lead configuration code.

LAL03

形名 Ordering code	公称 インダクタンス Inductance [μH]	インダクタンス 許容差 Inductance Tolerance	Q (min.)	測定 周波数 Measuring frequency [MHz]	自己共振 周波数 Self-resonant frequency [MHz] (min.)	直流抵抗 DC Resistance [Ω] (max.)	定格電流 Rated current [mA] (max.)		
LAL03○R22M	0.22	±20%	35.0	25.2	450.0	0.40	400.0		
LAL03○R27M	0.27				410.0	0.43	380.0		
LAL03○R33M	0.33				360.0	0.48	370.0		
LAL03○R39M	0.39				300.0	0.51	350.0		
LAL03○R47M	0.47				230.0	0.56	330.0		
LAL03○R56M	0.56				210.0	0.61	320.0		
LAL03○R68M	0.68		±10%	40.0	7.96	190.0	0.67	310.0	
LAL03○R82M	0.82					170.0	0.74	290.0	
LAL03○1R0M	1.0					150.0	0.80	270.0	
LAL03○1R2M	1.2					144.0	0.90	260.0	
LAL03○1R5M	1.5					131.0	1.0	250.0	
LAL03○1R8M	1.8					121.0	1.1	240.0	
LAL03○2R2M	2.2			±10%	50.0	2.52	110.0	1.2	230.0
LAL03○2R7M	2.7						100.0	1.3	220.0
LAL03○3R3K	3.3	94.0					1.4	210.0	
LAL03○3R9K	3.9	65.0					1.6	200.0	
LAL03○4R7K	4.7	56.0					1.7	190.0	
LAL03○5R6K	5.6	48.0					1.9	180.0	
LAL03○6R8K	6.8	±10%			50.0	0.796	37.0	2.0	175.0
LAL03○8R2K	8.2						25.0	2.2	165.0
LAL03○100K	10.0		21.0				2.5	160.0	
LAL03○120K	12.0		19.0				2.5	150.0	
LAL03○150K	15.0		17.0				2.8	145.0	
LAL03○180K	18.0		13.0				3.1	140.0	
LAL03○220K	22.0		±10%		50.0	0.796	9.6	3.4	130.0
LAL03○270K	27.0						7.2	3.8	125.0
LAL03○330K	33.0			6.3			4.1	120.0	
LAL03○390K	39.0			6.3			4.5	115.0	
LAL03○470K	47.0			6.3			4.9	110.0	
LAL03○560K	56.0			6.2			5.3	105.0	
LAL03○680K	68.0			±10%	50.0	0.796	5.7	5.8	100.0
LAL03○820K	82.0						5.3	6.3	95.0
LAL03○101K	100.0	4.8					7.0	90.0	
LAL03○121K	120.0	3.8					13.0	90.0	
LAL03○151K	150.0	3.5					15.0	85.0	
LAL03○181K	180.0	3.3					16.0	80.0	
LAL03○221K	220.0	±10%			50.0	0.796	3.0	17.0	75.0
LAL03○271K	270.0						2.8	19.0	65.0
LAL03○331K	330.0		2.6				20.0	60.0	
LAL03○391K	390.0		2.4				22.0	55.0	
LAL03○471K	470.0		2.25				24.0	55.0	
LAL03○561K	560.0		2.10				26.0	50.0	
LAL03○681K	680.0		±10%		50.0	0.796	1.95	28.0	45.0
LAL03○821K	820.0						1.85	30.0	40.0
LAL03○102K	1000.0			1.40			33.0	40.0	

形名の○にはリード加工形状記号が入ります。

○ Please specify the Lead configuration code.

LAL04

形名 Ordering code	公称 インダクタンス Inductance [μH]	インダクタンス 許容差 Inductance Tolerance	Q (min.)	測定 周波数 Measuring frequency [MHz]	自己共振 周波数 Self-resonant frequency [MHz] (min.)	直流抵抗 DC Resistance [Ω] (max.)	定格電流 Rated current [mA] (max.)			
LAL04○R22M	0.22	±20%	45.0	25.2	300.0	0.10	1400.0			
LAL04○R27M	0.27				270.0	0.11	1320.0			
LAL04○R33M	0.33				250.0	0.12	1280.0			
LAL04○R39M	0.39				230.0	0.13	1200.0			
LAL04○R47M	0.47				220.0	0.14	1150.0			
LAL04○R56M	0.56				200.0	0.15	1100.0			
LAL04○R68M	0.68				190.0	0.16	1030.0			
LAL04○R82M	0.82				172.0	0.17	980.0			
LAL04○1R0M	1.0				157.0	0.19	920.0			
LAL04○1R2M	1.2				144.0	0.21	880.0			
LAL04○1R5M	1.5	50.0	131.0	0.23	830.0					
LAL04○1R8M	1.8	55.0	121.0	0.25	790.0					
LAL04○2R2M	2.2	60.0	110.0	0.28	750.0					
LAL04○2R7M	2.7	65.0	100.0	0.30	720.0					
LAL04○3R3K	3.3	±10%	65.0	7.96	94.0	0.34	670.0			
LAL04○3R9K	3.9				65.0	0.37	640.0			
LAL04○4R7K	4.7				70.0	56.0	0.39	620.0		
LAL04○5R6K	5.6				48.0	0.43	590.0			
LAL04○6R8K	6.8				75.0	37.0	0.48	550.0		
LAL04○8R2K	8.2				80.0	25.0	0.52	530.0		
LAL04○100K	10.0				65.0	21.0	0.58	500.0		
LAL04○120K	12.0				50.0	19.0	0.63	480.0		
LAL04○150K	15.0							17.0	0.72	460.0
LAL04○180K	18.0							13.0	0.77	430.0
LAL04○220K	22.0	9.6	0.84	410.0						
LAL04○270K	27.0	7.2	0.94	390.0						
LAL04○330K	33.0	55.0	6.3	1.03				370.0		
LAL04○390K	39.0	50.0	6.3	1.12				350.0		
LAL04○470K	47.0	45.0	6.3	1.22				340.0		
LAL04○560K	56.0	40.0	6.2	1.34				320.0		
LAL04○680K	68.0	35.0	5.7	1.47				305.0		
LAL04○820K	82.0	30.0	5.3	1.62	290.0					
LAL04○101K	100.0	55.0	4.8	1.80	275.0					
LAL04○121K	120.0	45.0	3.8	3.70	185.0					
LAL04○151K	150.0	50.0	3.5	4.20	175.0					
LAL04○181K	180.0	55.0	3.3	4.60	165.0					
LAL04○221K	220.0	60.0	3.0	5.10	155.0					
LAL04○271K	270.0	65.0	0.796	2.8	5.80	145.0				
LAL04○331K	330.0			2.6	6.40	137.0				
LAL04○391K	390.0			2.4	7.00	133.0				
LAL04○471K	470.0			2.25	7.70	126.0				
LAL04○561K	560.0			2.10	8.50	120.0				
LAL04○681K	680.0			1.95	9.40	113.0				
LAL04○821K	820.0			55.0	1.85	10.50	105.0			
LAL04○102K	1000.0			50.0	1.40	14.00	100.0			

形名の○にはリード加工形状記号が入ります。
○ Please specify the Lead configuration code.

LAL05

形名 Ordering code	公称 インダクタンス Inductance [μH]	インダクタンス 許容差 Inductance Tolerance	Q (min.)	測定 周波数 Measuring frequency [MHz]	自己共振 周波数 Self-resonant frequency [MHz] (min.)	直流抵抗 DC Resistance [Ω] (max.)	定格電流 Rated current [A] (max.)		
LAL05○120K	12.0	±10%	30.0	2.52	11.0	0.15	1.05		
LAL05○150K	15.0				10.0	0.16	1.00		
LAL05○180K	18.0				9.0	0.18	0.82		
LAL05○220K	22.0				8.0	0.19	0.80		
LAL05○270K	27.0				7.0	0.21	0.70		
LAL05○330K	33.0				6.0	0.27	0.60		
LAL05○390K	39.0				5.5	0.30	0.54		
LAL05○470K	47.0				5.0	0.32	0.52		
LAL05○560K	56.0				20.0	0.796	4.5	0.36	0.49
LAL05○680K	68.0						4.0	0.40	0.45
LAL05○820K	82.0		3.7	0.43			0.40		
LAL05○101K	100.0		3.3	0.55			0.37		
LAL05○121K	120.0		3.0	1.10			0.31		
LAL05○151K	150.0		2.6	1.20			0.27		
LAL05○181K	180.0		2.3	1.30			0.25		
LAL05○221K	220.0		2.0	1.40			0.22		

形名の○にはリード加工形状記号が入ります。

○ Please specify the Lead configuration code.

直流重量特性例 DC Bias characteristics(Measured by HP4262A)

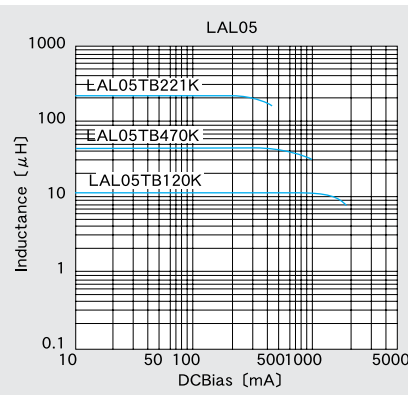
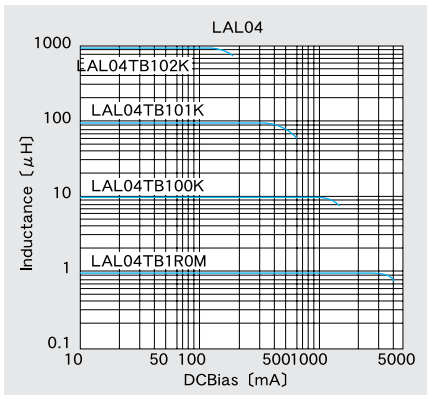
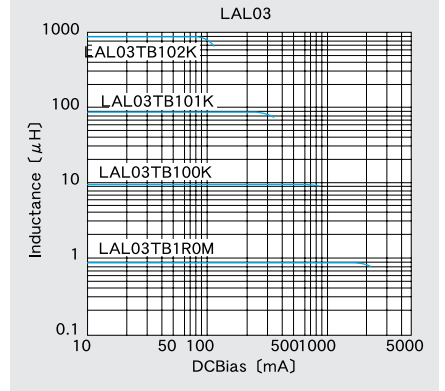
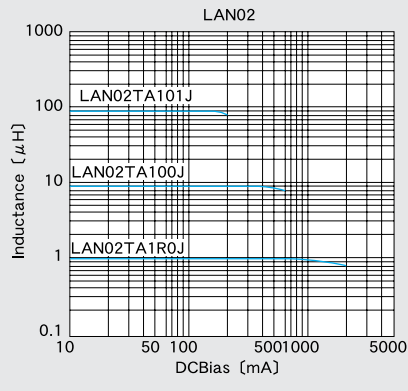
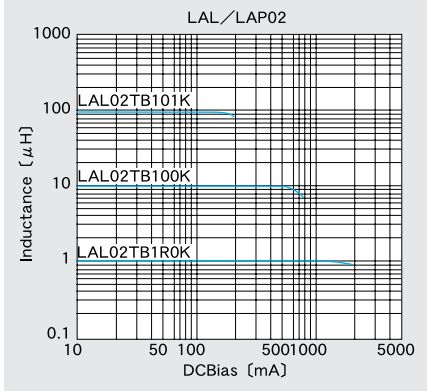

温度特性例 Temperature characteristics(Measured by HP4342A)

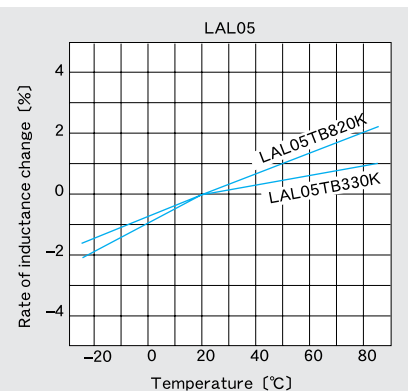
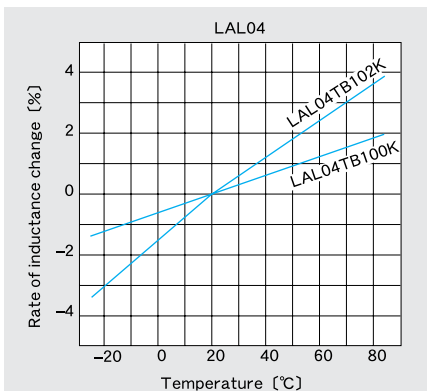
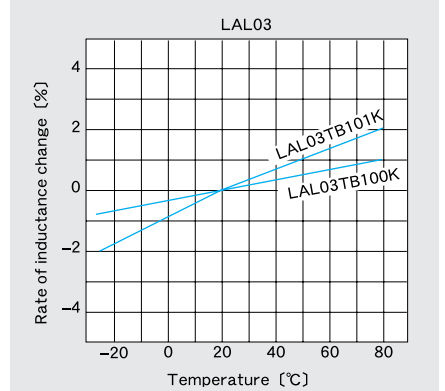
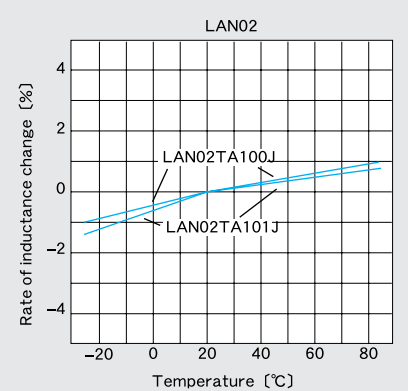
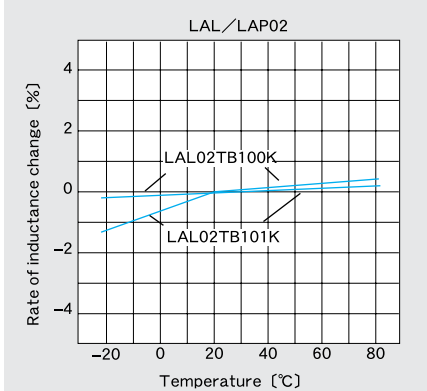

Q-周波数特性例 Q-Characteristics(Measured by HP4342A)

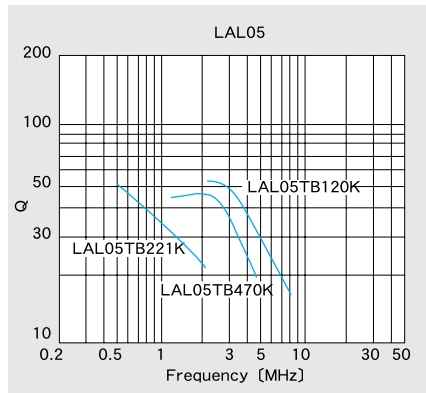
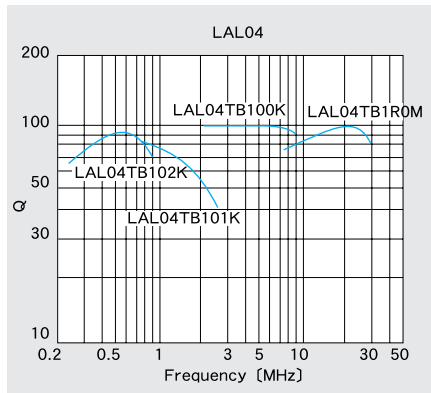
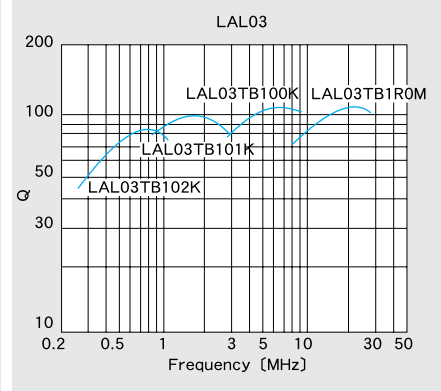
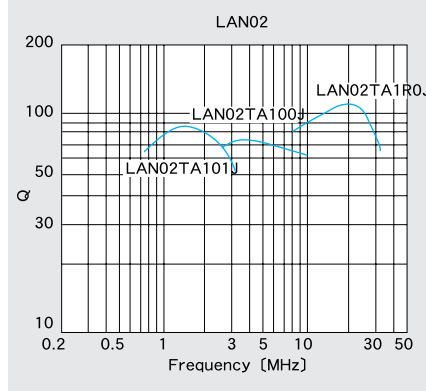
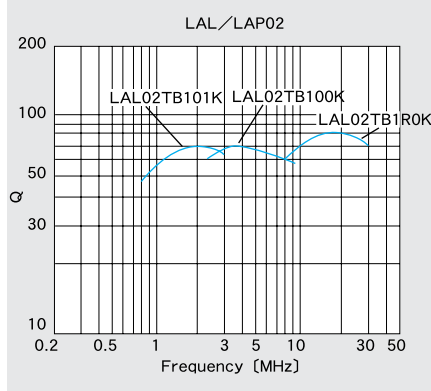

標準数量 Standard quantity

①アキシアルリードの横テーピング Taping for Straight Leads

Type	リード加工記号 Lead Configuration code	標準数量(pcs.) Standard quantity
LAL02	TB	2,000
LAP02	TA	2,000
LAN02	TA	2,000
LAL03	TA・TB	2,000
LAL04	TB	2,500
LAL05	TB	2,000

②アキシアルリードの縦テーピング Taping for Formed Leads

Type	リード加工記号 Lead Configuration code	標準数量(pcs.) Standard quantity
LAL02	VD・VA	2,000
LAL03	VB	2,000

③バルク(袋づめ) Bulk

Type	リード加工記号 Lead Configuration code	標準数量(pcs.) Standard quantity
LAL02	NA	500
LAP02	KR	2,000
LAN02	KR	500
LAL03	NA・KH	500
LAL04	NA・KB・SK	500

NA形状

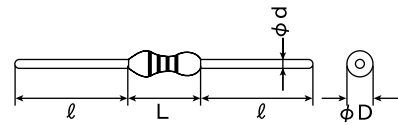

Type	寸法 Dimensions				最小挿入ピッチ Minimum insertion pitch
	ϕD	L	ϕd	l	
LAL02	2.3max (0.091max)	3.4max (0.134max)	0.50±0.05 (0.020±0.002)	24±2.0 (0.945±0.079)	5.0 (0.197)
LAL03	2.6 ^{+0.1} _{-0.2} (0.102 ^{+0.004} _{-0.008})	7.0max (0.276max)	0.50±0.05 (0.020±0.002)	22±2.0 (0.866±0.079)	10.0 (0.394)
LAL04	4.0max (0.157max)	9.8max (0.386max)	0.65±0.05 (0.026±0.002)	20±2.0 (0.787±0.079)	12.5 (0.492)

Unit : mm(inch)

KR/KH/KB形状

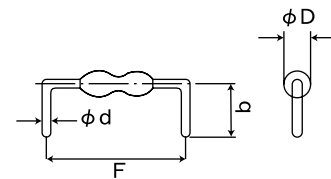

Type	リード加工 形状記号 Lead configuration code	寸法 Dimensions			
		ϕD	F	ϕd	b
LAP02	KR	2.3max (0.091max)	5.0±0.5 (0.197±0.020)	0.45±0.05 (0.018±0.002)	7.0±1.0 (0.276±0.039)
LAN02	KR	2.4max (0.094max)	5.0±0.5 (0.197±0.020)	0.45±0.05 (0.018±0.002)	7.0±1.0 (0.276±0.039)
LAL03	KH	2.6 ^{+0.1} _{-0.2} (0.102 ^{+0.004} _{-0.008})	10.0±0.5 (0.394±0.020)	0.50±0.05 (0.020±0.002)	6.5±0.5 (0.256±0.020)
LAL04	KB	4.0max (0.157max)	12.5±1.0 (0.492±0.039)	0.65±0.05 (0.026±0.002)	6.0±0.5 (0.236±0.020)

Unit : mm(inch)

SK形状

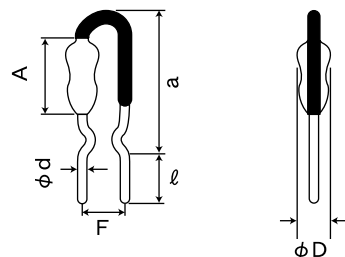

Type	寸法 Dimensions					
	A	a	ϕD	F	ϕd	l
LAL04	9.8max (0.386max)	14.0max (0.551max)	4.0max (0.157max)	5.0±1.5 (0.197±0.059)	0.65±0.05 (0.026±0.002)	6.0±1.0 (0.236±0.039)

Unit : mm(inch)

TA (a : 26mm lead space)形状
(1.02 inch)

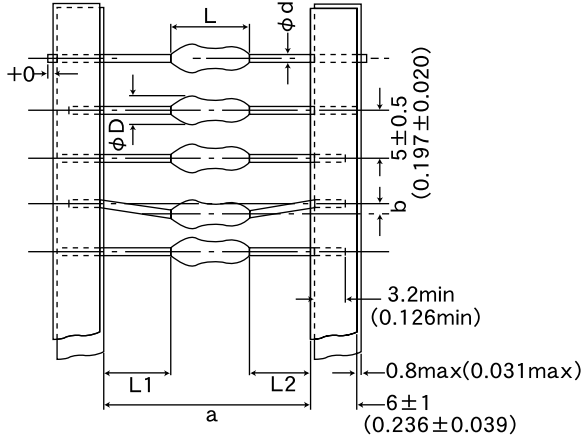

TB (a : 52mm lead space)形状
(2.05 inches)

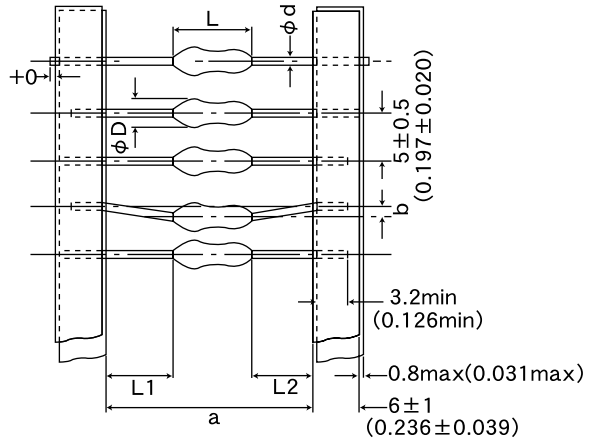

Type	寸法 Dimensions						最小挿入 ピッチ Minimum insertion pitch
	ϕD	L	a	b	$ L_1 - L_2 $	ϕd	
LAP02	2.3max (0.091max)	3.4max (0.134max)	$26^{+0.5}_{-0}$ (1.02 ^{+0.020} ₋₀)	0.8max (0.031max)	0.5max (0.020max)	0.45±0.05 (0.018±0.002)	5.0 (0.197)
LAN02	2.4max (0.094max)	3.6max (0.142max)	$26^{+0.5}_{-0}$ (1.02 ^{+0.020} ₋₀)	0.8max (0.031max)	0.5max (0.020max)	0.45±0.05 (0.018±0.002)	5.0 (0.197)
LAL03	$2.6^{+0.1}_{-0.2}$ (0.102 ^{+0.004} _{-0.008})	7.0max (0.276max)	$26^{+1}_{-0.5}$ (1.02 ^{+0.039} _{-0.020})	0.8max (0.031max)	1.0max (0.039max)	0.5±0.05 (0.020±0.002)	10.0 (0.394)

Unit : mm(inch)

Type	寸法 Dimensions						最小挿入 ピッチ Minimum insertion pitch
	ϕD	L	a	b	$ L_1 - L_2 $	ϕd	
LAL02	2.3max (0.091max)	3.4max (0.134max)	52^{+2}_{-1} (2.05 ^{+0.079} _{-0.039})	1.2max (0.047max)	1.0max (0.039max)	0.5±0.05 (0.020±0.002)	5.0 (0.197)
LAL03	$2.6^{+0.1}_{-0.2}$ (0.102 ^{+0.004} _{-0.008})	7.0max (0.276max)	52^{+2}_{-1} (2.05 ^{+0.079} _{-0.039})	1.2max (0.047max)	1.0max (0.039max)	0.5±0.05 (0.020±0.002)	10.0 (0.394)
LAL04	4.0max (0.157max)	9.8max (0.386)	52^{+2}_{-1} (2.05 ^{+0.079} _{-0.039})	1.2max (0.047max)	1.0max (0.039max)	0.65±0.05 (0.026±0.002)	12.5 (0.492)
LAL05	5.5max (0.217max)	14.0max (0.551)	52^{+2}_{-1} (2.05 ^{+0.079} _{-0.039})	1.2max (0.047max)	1.0max (0.039max)	0.65±0.05 (0.026±0.002)	17.5 (0.689)

Unit : mm(inch)

VD形状

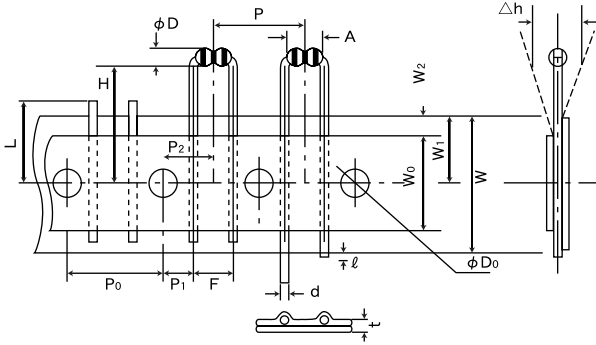

VA形状

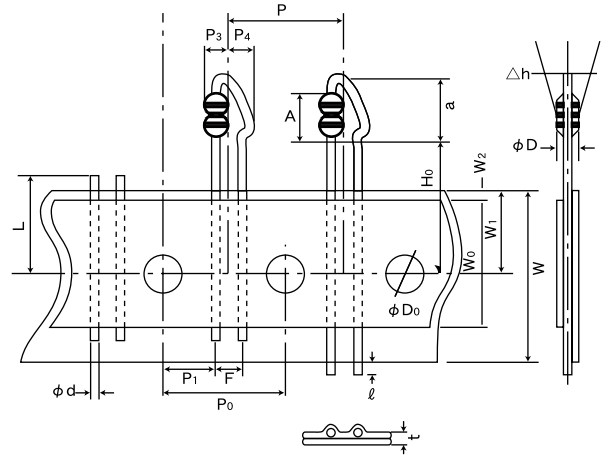

Type	記号 Symbol	寸法 Dimensions	記号 Symbol	寸法 Dimensions
LAL02	A	3.9max (0.154max)	W	18.0 ^{+1.0} _{-0.5} (0.709 ^{+0.039} _{-0.020})
	φD	2.3max (0.091max)	W ₀	12.5min (0.492min)
	H	19.5±0.5 (0.768±0.020)	W ₁	9.0 ^{+0.75} _{-0.5} (0.354 ^{+0.030} _{-0.020})
	P	12.7±1.0 (0.500±0.039)	W ₂	3.0max (0.118max)
	P ₀	12.7±0.3 (0.500±0.012)	ℓ	2.0max (0.079max)
	P ₁	3.85±0.7 (0.152±0.028)	φD ₀	4.0±0.3 (0.157±0.012)
	P ₂	6.35±0.5 (0.250±0.020)		
	F	5.08±0.5 (0.200±0.020)	φd	0.50±0.05 (0.020±0.002)
	Δh	0±1.0 (0±0.039)	L	11.0max (0.433max)
—	—	t	0.5±0.2 (0.020±0.008)	

Unit : mm(inch)

Type	記号 Symbol	寸法 Dimensions	記号 Symbol	寸法 Dimensions
LAL02	A	3.9max (0.154max)	W	18.0 ^{+1.0} _{-0.5} (0.709 ^{+0.039} _{-0.020})
	a	6.5max (0.256max)	W ₀	12.5min (0.492min)
	φD	2.3max (0.091max)	W ₁	9.0 ^{+0.75} _{-0.5} (0.354 ^{+0.030} _{-0.020})
	H ₀	16.0±1.0 (0.630±0.039)	W ₂	3.0max (0.118max)
	P	12.7±1.0 (0.500±0.039)	ℓ	2.0max (0.079max)
	P ₀	12.7±0.3 (0.500±0.012)	φD ₀	4.0±0.3 (0.157±0.012)
	P ₁	5.1±0.7 (0.201±0.028)	φd	0.50±0.05 (0.020±0.002)
	P ₂	6.35±0.5 (0.250±0.020)		
	P ₃	3.0max (0.118max)	L	11.0max (0.433max)
	P ₄	3.0max (0.118max)		
	F	2.5±0.5 (0.098±0.020)	t	0.5±0.2 (0.020±0.008)
	Δh	0±1.0 (0±0.039)	—	—

Unit : mm(inch)

VB形状

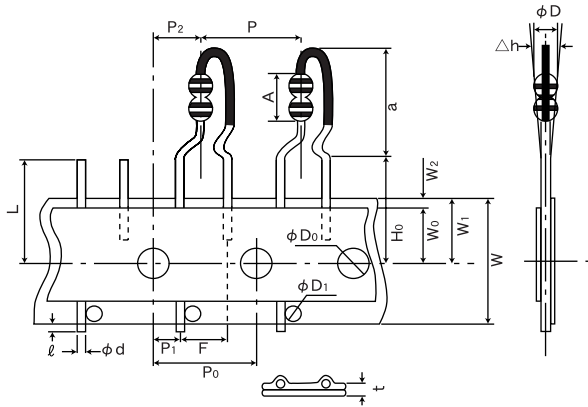

Type	記号 Symbol	寸法 Dimensions	記号 Symbol	寸法 Dimensions
LAL03	A	7.0max (0.276max)	W	18.0 ^{+1.0} _{-0.5} (0.709 ^{+0.039} _{-0.020})
	a	12.5max (0.492max)	W ₀	12.5min (0.492min)
	φD	2.7max (0.106max)	W ₁	9.0 ^{+0.75} _{-0.5} (0.354 ^{+0.030} _{-0.020})
	H ₀	16.0±0.5 (0.630±0.020)	W ₂	3.0max (0.118max)
	P	12.7±1.0 (0.500±0.039)	ℓ	1.0max (0.039max)
	P ₀	12.7±0.3 (0.500±0.012)	φD ₀	4.0±0.2 (0.157±0.008)
	P ₁	3.85±0.7 (0.152±0.028)	φD ₁	3.5max (0.138max)
	P ₂	6.35±1.0 (0.250±0.039)	φd	0.60±0.05 (0.024±0.002)
	F	5.0±1.0 (0.197±0.039)	L	11.0max (0.433max)
Δh	0±2.0 (0±0.079)	t	0.7±0.2 (0.028±0.008)	

Unit : mm(inch)

Item	Specified Value								Test Method and Remarks
	LA02 Type/ LA03 Type	LA04 Type	LA05 Type	LHL□□□/ LHF15BB/ LHFP□□BB	FBA/FBR	LAV35	FL05□ Type	FL06BT Type	
1. Operating temperature Range	-25~+105°C				-25~+85°C	-25~+105°C			LA・FL : Including self-generated heat LHL・LHF・LHFP : Including self-generated heat [LHL□□□, LHF15BB]
2. Storage temperature Range	-40~+85°C								
3. Rated current	Within the specified tolerance								LA : The maximum DC value having inductance within 10% and temperature increase within 20°C by the application of DC bias. LHL・LHF・LHFP・LAV35 : The maximum DC value having inductance decrease within 10% and temperature increase within the following specified temperature by the application of DC bias. 規定温度：20°C(LHL06, LAV35) : 25°C(LHL08, LHL10, LHL13) : 30°C(LHLC06, LHLZ06, LHL16, LHF15BB, LHFP□□BB) FB : No disconnection or appearance abnormality by continuous current application for 30 min. Chage after the application shall be within ±20% of the initial value. This is not guaranteed for electrical characteristics during current application. FL : The maximum DC value having temperature rise within specified value.
4. Impedance					Within the specified tolerance			Refer to individual specification	FB : Measuring equipment : Impedance analyzer (HP4191A) or its equivalent Measuring frequency : Specified frequency FL06BT : Measuring equipment : 4291A (HP) or its equivalent Measuring frequency : Specified frequency
5. Inductance	Within the specified tolerance					Within the specified tolerance			LA : Measuring equipment : LCR meter(HP4285A + HP42851A or its equivalent) Measuring frequency : Specified frequency LHL・LHF・LHFP : Measuring equipment : Q meter(HP4285A+HP42851A or its equivalent) LCR meter(HP4262A) or its equivalent(at 1KHz) Measuring frequency : Specified frequency LAV35 : Measuring equipment : Q meter(HP4285A+HP42851A or its equivalent) Measuring frequency : Specified frequency FL05R□ : Measuring equipment : HP4262A or its equivalent. Measuring frequency : 1KHz

Item	Specified Value								Test Method and Remarks												
	LA02 Type/ LA03 Type	LA04 Type	LA05 Type	LHL□□□/ LHF15BB/ LHFP□□BB	FBA/FBR	LAV35	FL05□ Type	FL06BT Type													
6.Q	Within the specified tolerance					Within the specified tolerance			LA : Measuring equipment : LCR meter(HP4285A+HP42851A or its equivalent) Measuring frequency : Specified frequency LHL · LHF · LHFP · LAV35 : Measuring equipment : Q meter(HP4285A+HP42851A or its equivalent) Q meter(HP4342A) or its equivalent Measuring frequency : Specified frequency												
7.DC Resistance	Within the specified tolerance								LA : Measuring equipment : low ohmmeter (A&D AD5812 or its equivalent) LHL · LHF · LHFP · FB · LAV35 · FL : Measuring equipment : DC ohmmeter												
8.Self resonance frequency	Within the specified tolerance					Within the specified tolerance			LA : Measuring equipment : Network analyzer(Anritsu MS620J or its equivalent) LHL · LHF · LHFP · LAV35 : Measuring equipment : (HP4191A, 4192A) its equivalent												
9.Temperature characteristic	$\Delta L/L$: Within±5%			$\Delta L/L$: Within±7%		$\Delta L/L$: Within±5%			LA : Change of maximum inductance deviation in step 1to5 <table border="1" style="margin-left: 20px;"> <thead> <tr> <th>step</th> <th>Temperature(°C)</th> </tr> </thead> <tbody> <tr> <td>1</td> <td>20</td> </tr> <tr> <td>2</td> <td>-25 (Minimum operating temperature)</td> </tr> <tr> <td>3</td> <td>20 (Standard temperature)</td> </tr> <tr> <td>4</td> <td>+85 (Maximum operating temperature)</td> </tr> <tr> <td>5</td> <td>20</td> </tr> </tbody> </table> LHL · LHF · LHFP · LAV35 : [LHL□□□, LHF15BB, LAV35, LHFP□□BB] Change of maximum inductance deviation in step 1to5 Temperature at step 1 : 20°C Temperature at step 2 : Minimum operating temperature Temperature at step 3 : 20°C (Standard temperature) Temperature at step 4 : Maximum operating temperature Temperature at step 5 : 20°C	step	Temperature(°C)	1	20	2	-25 (Minimum operating temperature)	3	20 (Standard temperature)	4	+85 (Maximum operating temperature)	5	20
step	Temperature(°C)																				
1	20																				
2	-25 (Minimum operating temperature)																				
3	20 (Standard temperature)																				
4	+85 (Maximum operating temperature)																				
5	20																				

Item	Specified Value								Test Method and Remarks																					
	LA02 Type/ LA03 Type	LA04 Type	LA05 Type	LHL□□□/ LHF15BB/ LHFP□□BB	FBA/FBR	LAV35	FL05□ Type	FL06BT Type																						
10. Terminal strength : tensile force	No abnormality such as cut lead, or looseness.			No abnormality such as cut lead, or looseness.	No abnormality such as cut lead, or looseness.				LA : Apply the stated tensile force progressively in the direction to draw terminal. <table border="1"> <tr> <th>force(N)</th> <th>duration(S)</th> </tr> <tr> <td>25</td> <td>5</td> </tr> </table> LHL · LHF · LAV · LHFP : Apply the stated tensile force progressively in the direction to draw terminal. <table border="1"> <tr> <th>Nominal wire diameter tensile ϕd(mm)</th> <th>force (N)</th> <th>duration(S)</th> </tr> <tr> <td>0.3 < ϕd ≤ 0.5</td> <td>5</td> <td rowspan="3">30±5</td> </tr> <tr> <td>0.5 < ϕd ≤ 0.8</td> <td>10</td> </tr> <tr> <td>0.8 < ϕd ≤ 1.2</td> <td>25</td> </tr> </table> FBA : 本体を固定し、端子方向に20±1Nの引張力を10±1秒間加える。 FL05R□ : Fix the component in the direction to draw terminal, and gradually apply the tensile force of 4.9 N.	force(N)	duration(S)	25	5	Nominal wire diameter tensile ϕd (mm)	force (N)	duration(S)	0.3 < ϕd ≤ 0.5	5	30±5	0.5 < ϕd ≤ 0.8	10	0.8 < ϕd ≤ 1.2	25							
force(N)	duration(S)																													
25	5																													
Nominal wire diameter tensile ϕd (mm)	force (N)	duration(S)																												
0.3 < ϕd ≤ 0.5	5	30±5																												
0.5 < ϕd ≤ 0.8	10																													
0.8 < ϕd ≤ 1.2	25																													
11. Over current				There shall be no scorch or short of wire.					LHL · LHF · LHFP : Measuring current : Rated current×2 Duration : 5min. Number of measuring : one time																					
12. Terminal strength : bending	No abnormality such as cut lead, or looseness.								LA : Suspend a mass at the end the terminal, incline the body though angel of 90 and return it to initial position. This operation is done over a period of 2-3 sec. Then second bend in the opposite direction shall be made. Number of bends : Two times. <table border="1"> <tr> <th>Nominal wire diameter tensile ϕd(mm)</th> <th>Bending force (N)</th> <th>Mass reference weight (kg)</th> </tr> <tr> <td>0.3 < ϕd ≤ 0.5</td> <td>2.5</td> <td>0.25</td> </tr> <tr> <td>0.5 < ϕd ≤ 0.8</td> <td>5</td> <td>0.50</td> </tr> </table> LH · FB · LAV : Suspend a mass at the end the terminal, incline the body though angel of 90 and return it to initial position. This operation is done over a period of 2-3 sec. Then second bend in the opposite direction shall be made. Number of bends : Two times. <table border="1"> <tr> <th>Nominal wire diameter tensile ϕd(mm)</th> <th>Bending force (N)</th> <th>Mass reference weight (kg)</th> </tr> <tr> <td>0.3 < ϕd ≤ 0.5</td> <td>2.5</td> <td>0.25</td> </tr> <tr> <td>0.5 < ϕd ≤ 0.8</td> <td>5</td> <td>0.5</td> </tr> <tr> <td>0.8 < ϕd ≤ 1.2</td> <td>10</td> <td>1.0</td> </tr> </table>	Nominal wire diameter tensile ϕd (mm)	Bending force (N)	Mass reference weight (kg)	0.3 < ϕd ≤ 0.5	2.5	0.25	0.5 < ϕd ≤ 0.8	5	0.50	Nominal wire diameter tensile ϕd (mm)	Bending force (N)	Mass reference weight (kg)	0.3 < ϕd ≤ 0.5	2.5	0.25	0.5 < ϕd ≤ 0.8	5	0.5	0.8 < ϕd ≤ 1.2	10	1.0
Nominal wire diameter tensile ϕd (mm)	Bending force (N)	Mass reference weight (kg)																												
0.3 < ϕd ≤ 0.5	2.5	0.25																												
0.5 < ϕd ≤ 0.8	5	0.50																												
Nominal wire diameter tensile ϕd (mm)	Bending force (N)	Mass reference weight (kg)																												
0.3 < ϕd ≤ 0.5	2.5	0.25																												
0.5 < ϕd ≤ 0.8	5	0.5																												
0.8 < ϕd ≤ 1.2	10	1.0																												
13. Insulation resistance : between the terminals and body				100M Ω min.					LHL · LHF : Applied voltage : 500 VDC Duration : 60 sec.																					
14. Insulation resistance : between terminals and core					1M Ω min. (Other than material code MA)				FBA · FBR : Applied voltage : 100 VDC Duration : 60±5 sec.																					
15. Withstanding : between the terminals and body				No abnormality such as insulation damage					[LHL□□□, LHF15BB] According to JIS C5102. 7. 1. 3 (C) Metal global method Applied voltage : 500 VDC Duration : 60 sec.																					

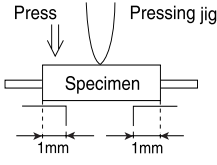
Item	Specified Value								Test Method and Remarks
	LA02 Type/ LA03 Type	LA04 Type	LA05 Type	LHL□□□/ LHF15BB/ LHFP□□BB	FBA/FBR	LAV35	FL05□ Type	FL06BT Type	
16.DC bias characteristic	ΔL/L : Within -10%					ΔL/L : -10% Within			LA · LAV35 : Measure inductance with application of rated current using LCR meter to compare it with the initial value.
17.Body strength	No abnormality as damage.				No significant damage such as cracks on body.	No abnormality as damage.			LA02 · LAV35 : Applied force : 30N Duration : 10 sec. Speed : Shall attain to specified force in 2 sec. LA03 · LA04 · LA05 : Applied force : 50N Duration : 10 sec. Speed : Shall attain to specified force in 2 sec. FB : Applied force : 50±3N Duration : 30±1 sec. 
18.Resistance to vibration	ΔL/L : Within±5% Q : 30min.	ΔL/L : Within±5% ΔQ/Q : Within±10%	ΔL/L : Within±5% Q : 15min.	Appearance : No abnormality ΔL/L : Within±5% Q change : Within±30%	Appearance : No abnormality Impedance change : Within±20%	ΔL/L : Within±5% Q : 30min.			LA : According to JIS C5102 8. 2 Vibration type : A Directions : 2 hrs each in X, Y and Z directions total : 6hrs. Frequency range : 10 to 55 to 10Hz(1min.) Amplitude : 1.5mm Mounting method : Soldering onto printed board. Recovery : At least 1hr of recovery under the standard condition after the test, followed by the measurement within 2hrs. LHL · LHF · LHFP · FB · LAV : According to JIS C0040 Vibration type : A Directions : 2 hrs each in X, Y and Z directions total : 6hrs. Frequency range : 10 to 55 to 10Hz(1min.) Amplitude : 1.5mm (But don't exceed acceleration 196m/s (two power) Mounting method : Soldering onto printed board.

Item	Specified Value								Test Method and Remarks
	LA02 Type/ LA03 Type	LA04 Type	LA05 Type	LHL□□□/ LHF15BB/ LHFP□□BB	FBA/FBR	LAV35	FL05□ Type	FL06BT Type	
19. Resistance to shock	No significant abnormality in appearance					No significant abnormality in appearance			LA・LAV35 : Drop test Impact material : concrete or vinyl tile Height : 1m Total number of drops : 10 times
20. Solderability	At least 75% of terminal electrode is covered by new solder.		At least 75% of lead	At least 90% of lead	At least 75% of lead	At least 75% of lead			LA : Solder temperature : 230±5°C Duration : 2±0.5 sec. LHL・LHF・LHFP : Solder temperature : 235±5°C Duration : 2±0.5 sec. Immersion depth : Up to 1.5mm from bottom of kinked part. [LHL06, LHLC06, LHLZ06] : Up to 1.5mm from bottom of case. [LHL08, LHL10, LHL13, LHL16] : Up to 1.5mm from bottom of base. [LHF15BB, LHFP□□BB] FB : Solder temperature : 230±5°C Duration : 3±1 sec. Immersion depth : Up to 1.5mm from terminal root. LAV35 : Solder temperature : 230±5°C Duration : 2±0.5 sec. FL05R□ : Solder temperature : 230±5°C Duration : 2±0.5 sec. Immersion depth : Up to 2~2.5mm from terminal root. FL06BT : Solder temperature : 230±5°C Duration : 3±1 sec. Immersion depth : Up to 0.5~1.0mm from terminal root.

Item	Specified Value								Test Method and Remarks
	LA02 Type/ LA03 Type	LA04 Type	LA05 Type	LHL□□□□/ LHF15BB/ LHFP□□BB	FBA/FBR	LAV35	FL05□ Type	FL06BT Type	
21. Resistance to soldering heat	No significant abnormality in appearance		<p>△L/L : Within ±5% Q : 15min.</p>	<p>No significant abnormality in appearance Inductance change : Within±5% Q change : Within±30%</p>	<p>No significant abnormality in appearance Impedance change : Within±20%</p>	<p>△L/L : Within±5% Q : 30min.</p>	Refer to individual specification	<p>No significant abnormality in appearance Impedance change : Within±20%</p>	<p>LA : Solder temperature : 260±5°C(LA02) 270±5°C(LA03 · LA04 · LA05) Duration : 5±0.5 sec. One time Immersion conditions : Inserted into substrate with t = 1.6mm Recovery : At least 1hr of recovery under the standard condition after the test, followed by the measurement within 2hrs. LHL · LHF · LHFP : Solder bath method Solder temperature : 260±5°C Duration : 10±1 sec. : Up to 1.5mm from bottom of kinked part. [LHL06, LHLC06, LHLZ06] : Up to 1.5mm from bottom of case. [LHL08, LHL10, LHL13, LHL16] : Up to 1.5mm from bottom of base. [LHF15BB, LHFP□□BB] Manual soldering Solder temperature : 350±10°C(At the tip of soldering iron) Duration : 5±1 sec. : Up to 1.5mm from bottom of kinked part. [LHL06, LHLC06, LHLZ06] : Up to 1.5mm from bottom of case. [LHL08, LHL10, LHL13, LHL16] : Up to 1.5mm from bottom of base. [LHF15BB, LHFP□□BB] Caution : No excessive pressing shall be applied to terminal Recovery : 4 to 24hrs of recovery under the standard condition after the test. FB : Solder bath method Condition 1 Solder temperature : 260±5°C Duration : 10±1 sec. Immersion depth : Up to 1.5mm from terminal root. Condition 2 Solder temperature : 350±5°C Duration : 3±1 sec. Immersion depth : Up to 1.5mm from terminal root. Recovery : 3hrs of recovery under the standard condition after the test. LAV35 : Solder temperature : 260±5°C Duration : 5±0.5 sec. Immersion depth : Up to 2.0 to 2.5mm from bottom of kinked part. Recovery : 4 to 24hrs of recovery under the standard condition after the test. FL : Solder condition : 260±5°C 10±1 sec. Immersion depth : Up to 0.5 to 1.0mm from terminal root. Recovery : 3hrs of recovery under the standard condition after the test.</p>

Item	Specified Value								Test Method and Remarks																																																												
	LA02 Type/ LA03 Type	LA04 Type	LA05 Type	LHL□□□/ LHF15BB/ LHFP□□BB	FBA/FBR	LAV35	FL05□ Type	FL06BT Type																																																													
22. Resisittance to solvent	Pleasa avoid the ultrasonic cleaning of this product.				No signifi- cant abnor- mality in ap- pearance Impedance change : Within±20%	P l e a s e avoid the ul- tra s o n i c cleaning of this product.			FB : Solvent temperature : 20~25°C Duration : 30±5 sec. Solvent type : Acetone, trichloroethylene Recovery : 3hrs of recovery under the standard condition after the test.																																																												
23. Thermnal shock	△L/L : Within±10% Q : 30min.	△L/L : Within±10% △Q/Q : Within±30%	△L/L : Within±10% Q : 15min.	Appearance : No abnor- mality Inductance change : Within±10% Q change : Within±30%	Appearance : No abnor- mality Impedance change : Within±20%	△L/L : Within±10% Q : 20min.	Refer to individual specifica- tion	Appearance : No abnor- mality Impedance change : Within±20%	LA : Conditions for 1cycle <table border="1"> <thead> <tr> <th>Step</th> <th>Temperature(°C)</th> <th>Duration(min)</th> </tr> </thead> <tbody> <tr> <td>1</td> <td>-25⁺⁰₋₃</td> <td>30±3</td> </tr> <tr> <td>2</td> <td>Room temperature</td> <td>Within 3</td> </tr> <tr> <td>3</td> <td>+85⁺²₋₀</td> <td>30±3</td> </tr> <tr> <td>4</td> <td>Room temperature</td> <td>Within 3</td> </tr> </tbody> </table> <p>Number of cycles : 5 cycles Recovery : At least 1hr of recovery under the standard condition after the removal from test chamber, followed by the measurement within 2hrs.</p> <p>LHL · LHF · FB : Accoding to JIS C0025 Conditions for 1 cycle <table border="1"> <thead> <tr> <th>Step</th> <th>Temperature(°C)</th> <th>Duration(min)</th> </tr> </thead> <tbody> <tr> <td>1</td> <td>Minimum operating temperature⁺⁰₋₃</td> <td>30±3</td> </tr> <tr> <td>2</td> <td>Room temperature</td> <td>Within 3</td> </tr> <tr> <td>3</td> <td>Maximum oparating temperature⁺²₋₀</td> <td>30±3</td> </tr> <tr> <td>4</td> <td>Room temperature</td> <td>Within 3</td> </tr> </tbody> </table> <p>Number of cycles : 10 cycles (LHL□□□, LHF□□BB, LHF15BB) : 5 cycles(FBA, FBR) Recovery : 4 to 24hrs of recovery under the standard condition after the removal from the test cfamber. (LHL□□□, LHF□□BB, LHF15BB) : 3hrs of recovery under the standard condition af- ter the removal from the test cfamber.(FBA, FBR)</p> <p>LAV : Conditions for 1 cycle <table border="1"> <thead> <tr> <th>Step</th> <th>Temperature(°C)</th> <th>Duration(min)</th> </tr> </thead> <tbody> <tr> <td>1</td> <td>Minimum operating temperature⁺⁰₋₃</td> <td>30±3</td> </tr> <tr> <td>2</td> <td>Room temperature</td> <td>Within 3</td> </tr> <tr> <td>3</td> <td>Maximum oparating temperature⁺²₋₀</td> <td>30±3</td> </tr> <tr> <td>4</td> <td>Room temperature</td> <td>Within 3</td> </tr> </tbody> </table> <p>Number of cycles : 10 cycles Recovery : At least 1hr of recovery under the standard condition after the removal from test chamber, followed by the measurement within 2hrs.</p> <p>FL : Accoding to JIS C0025 Conditions for 1 cycle <table border="1"> <thead> <tr> <th>Step</th> <th>Temperature(°C)</th> <th>Duration(min)</th> </tr> </thead> <tbody> <tr> <td>1</td> <td>-25⁺⁰₋₃</td> <td>30±3</td> </tr> <tr> <td>2</td> <td>Room temperature</td> <td>Within 3</td> </tr> <tr> <td>3</td> <td>+85⁺²₋₀</td> <td>30±3</td> </tr> <tr> <td>4</td> <td>Room temperature</td> <td>Within 3</td> </tr> </tbody> </table> <p>Number of cycles : 10 cycles Recovery : 1 to 2hrs of recovery under the standard condition after the removal from the test cfamber.</p> </p></p></p>	Step	Temperature(°C)	Duration(min)	1	-25 ⁺⁰ ₋₃	30±3	2	Room temperature	Within 3	3	+85 ⁺² ₋₀	30±3	4	Room temperature	Within 3	Step	Temperature(°C)	Duration(min)	1	Minimum operating temperature ⁺⁰ ₋₃	30±3	2	Room temperature	Within 3	3	Maximum oparating temperature ⁺² ₋₀	30±3	4	Room temperature	Within 3	Step	Temperature(°C)	Duration(min)	1	Minimum operating temperature ⁺⁰ ₋₃	30±3	2	Room temperature	Within 3	3	Maximum oparating temperature ⁺² ₋₀	30±3	4	Room temperature	Within 3	Step	Temperature(°C)	Duration(min)	1	-25 ⁺⁰ ₋₃	30±3	2	Room temperature	Within 3	3	+85 ⁺² ₋₀	30±3	4	Room temperature	Within 3
Step	Temperature(°C)	Duration(min)																																																																			
1	-25 ⁺⁰ ₋₃	30±3																																																																			
2	Room temperature	Within 3																																																																			
3	+85 ⁺² ₋₀	30±3																																																																			
4	Room temperature	Within 3																																																																			
Step	Temperature(°C)	Duration(min)																																																																			
1	Minimum operating temperature ⁺⁰ ₋₃	30±3																																																																			
2	Room temperature	Within 3																																																																			
3	Maximum oparating temperature ⁺² ₋₀	30±3																																																																			
4	Room temperature	Within 3																																																																			
Step	Temperature(°C)	Duration(min)																																																																			
1	Minimum operating temperature ⁺⁰ ₋₃	30±3																																																																			
2	Room temperature	Within 3																																																																			
3	Maximum oparating temperature ⁺² ₋₀	30±3																																																																			
4	Room temperature	Within 3																																																																			
Step	Temperature(°C)	Duration(min)																																																																			
1	-25 ⁺⁰ ₋₃	30±3																																																																			
2	Room temperature	Within 3																																																																			
3	+85 ⁺² ₋₀	30±3																																																																			
4	Room temperature	Within 3																																																																			

Item	Specified Value								Test Method and Remarks
	LA02 Type/ LA03 Type	LA04 Type	LA05 Type	LHL□□□/ LHF15BB/ LHFP□□BB	FBA/FBR	LAV35	FL05□ Type	FL06BT Type	
24.Damp heat	ΔL/L : Within±10% Q : 30min.	ΔL/L : Within±10% ΔQ/Q : Within±30%	ΔL/L : Within±10% Q : 15min.		Appearance : No abnormality Impedance change : Within±20%	ΔL/L : Within±10% Q : 20min.			LA · LAV35 : Temperature : 40±2°C Humidity : 90~95%RH Duration : 1000 hrs Recovery : At least 1hr of recovery under the standard removal from test chamber, followed by the measurement within 2hrs. FB : Temperature : 60±2°C Humidity : 90~95%RH Duration : 1000 hrs Recovery : 1 to 2hrs of recovery under the standard condition after the removal from the test chamber.
25.Loading under damp heat	ΔL/L : Within±10% Q : 30min.	ΔL/L : Within±10% ΔQ/Q : Within±30%	ΔL/L : Within±10% Q : 15min.	Appearance : No abnormality Inductance change : Within±10% Q change : Within±30%		ΔL/L : Within±10% Q : 20min.	Refer to individual specification	Appearance : No abnormality Impedance change : Within±20%	LA · LAV35 : Temperature : 40±2°C Humidity : 90~95%RH Duration : 1000 hrs Applied current : Rated current Recovery : At least 1hr of recovery under the standard removal from test chamber, followed by the measurement within 2hrs. LHL · LHF · LHFP : Temperature : 40±2°C Humidity : 90~95%RH Duration : 1000±24 hrs Applied current : Rated current Recovery : 1 to 2hrs of recovery under the standard condition after the removal from the test chamber. FL : Temperature : 60±3°C Humidity : 90~95%RH Duration : 500 (+12, -0)hrs Applied current : Rated current Recovery : 1 to 2hrs of recovery under the standard condition after the removal from the test chamber.
26.Loading at high temperature	ΔL/L : Within±10% Q : 30min.	ΔL/L : Within±10% ΔQ/Q : Within±30%	ΔL/L : Within±10% Q : 15min.			ΔL/L : Within±10% Q : 20min.			LA · LAV35 : Temperature : 85±2°C Duration : 1000 hrs Applied current : Rated current Recovery : At least 1hr of recovery under the standard removal from test chamber, followed by the measurement within 2hrs.

Item	Specified Value								Test Method and Remarks
	LA02 Type/ LA03 Type	LA04 Type	LA05 Type	LHL□□□/ LHF15BB/ LHFP□□BB	FBA/FBR	LAV35	FL05□ Type	FL06BT Type	
27.Low temperature life test	△L/L : Within±10% Q : 30min.	△L/L : Within±10% △Q/Q : Within±30%	△L/L : Within±10% Q : 15min.	Appearance : No abnormality Inductance change : Within±10% Q change : Within±30%		△L/L : Within±10% Q : 20min.	Refer to individual specification	Appearance : No abnormality Impedance change : Within±20%	LA : Temperature : -25±2°C Duration : 1000 hrs Recovery : At least 1hr of recovery under the standard removal from test chamber, followed by the measurement within 2hrs. LHL · LHF · LHFP : Temperature : -40±3°C Duration : 1000±24 hrs Recovery : 1 to 2hrs of recovery under the standard condition after the removal from the test chamber. LAV35 : Temperature : -40±3°C Duration : 1000 hrs Recovery : At least 1hr of recovery under the standard removal from test chamber, followed by the measurement within 2hrs. FL : Temperature : -40±3°C Duration : 500(+12, -0)hrs Recovery : 1 to 2hrs of recovery under the standard condition after the removal from the test chamber.
28.High temperature life test				Appearance : No abnormality Inductance change : Within±10% Q change : Within±30%			Refer to individual specification	Appearance : No abnormality Impedance change : Within±20%	LHL · LHF · LHFP : Temperature : 105±3°C Duration : 1000±24 hrs Recovery : 1 to 2hrs of recovery under the standard condition after the removal from the test chamber. FL : Temperature : 85±3°C Duration : 500(+12, -0)hrs Recovery : 1 to 2hrs of recovery under the standard condition after the removal from the test chamber.

PRECAUTIONS

LA Type, LH Type, FB Type, FL Type

Stages	Precautions	Technical considerations
1.Circuit Design	<p>Operating environment,</p> <p>1.The products described in this specification are intended for use in general electronic equipment,(office supply equipment, telecommunications systems, measuring equipment, and household equipment). They are not intended for use in mission-critical equipment or systems requiring special quality and high reliability (traffic systems, safety equipment, aerospace systems, nuclear control systems and medical equipment including life-support systems,) where product failure might result in loss of life, injury or damage. For such uses, contact TAIYO YUDEN Sales Department in advance.</p>	
2.PCB Design	<p>Design</p> <p>1.Please design insertion pitches of a base in the pitches that fitted a terminal interval.</p>	<p>1.When Inductors are mounted onto a PC board, hole dimensions on the board should match the lead pitch of the component, if not, it will cause breakage of the terminals or cracking of terminal roots covered with resin as excess stress travels through the terminal legs.</p>
3.Considerations for automatic placement	<p>Adjustment of mounting machine</p> <p>1.Excessive impact load should not be imposed on the products when mounting onto the PC boards.</p> <p>2.Mounting and soldering conditions should be checked beforehand.</p>	<p>1. When installing products, care should be taken not to apply distortion stress as it may deform the products.</p>
4.Soldering	<p>Wave soldering</p> <p>1.Please refer to the specifications in the catalog for a wave soldering.</p> <p>2.Do not immerse the entire Inductors in the flux during the soldering operation.</p> <p>Lead free soldering</p> <p>1.When using products with lead free soldering, we request to use them after confirming of adhesion, temperature of resistance to soldering heat, soldering etc sufficiently.</p> <p>Recommended conditions for using a soldering iron: Put the soldering iron on the land-pattern. Soldering iron's temperature - Below 350 °C Duration - 3 seconds or less The soldering iron should not directly touch the inductor.</p>	<p>1.If products are used beyond the range of the recommended conditions, heat stresses may deform the products, and consequently degrade the reliability of the products.</p>
5.Cleaning	<p>Cleaning conditions</p> <p>1.LA type, LH type Please do not do cleaning by a supersonic wave.</p>	<p>LA type, LH type</p> <p>1.If washing by supersonic waves, supersonic waves may deform products.</p>
6.Handling	<p>Handling</p> <p>1.Keep the inductors away from all magnets and magnetic objects.</p> <p>Mechanical considerations</p> <p>1.Please do not give the inductors any excessive mechanical shocks.</p> <p>2.LH type If inductors are dropped onto the floor or a hard surface they should not be used.</p> <p>Packing</p> <p>1.Please do not give the inductors any excessive mechanical shocks.</p> <p>In loading, please pay attention to handling indication mentioned in a packing box (a loading direction / number of maximum loading / fragile item).</p>	<p>1.There is a case that a characteristic varies with magnetic influence.</p> <p>1.There is a case to be damaged by a mechanical shock.</p> <p>2.LH type There is a case to be broken by a fall.</p> <p>1.There is a case that a lead route turns at by a fall or an excessive shock.</p>
7.Storage conditions	<p>Storage</p> <p>Storage</p> <p>1.To maintain the solderability of terminal electrodes and to keep the packing material in good condition, temperature and humidity in the storage area should be controlled..</p> <p>• Recommended conditions</p> <p>Ambient temperature 0~40°C</p> <p>Humidity Below 70 % RH</p> <p>The ambient temperature must be kept below 30°C. Even under ideal storage conditions, solderability of products electrodes may decrease as time passes. For this reason, inductors should be used within one year from the time of delivery.</p> <p>In case of storage over 6 months, solderability shall be checked before actual usage.</p>	<p>1. Under a high temperature and humidity environment, problems such as reduced solderability caused by oxidation of terminal electrodes and deterioration of taping/package materials may take place.</p>