

NR01 Series Process Sealed Rotaries



**Subminiature Rotaries with
Positive, Distinctive Detent**

General Specifications

Electrical Capacity (Resistive Load)

Logic Level: 0.4VA maximum @ 28V AC/DC maximum
(Applicable Range 0.1mA ~ 0.1A @ 20mV ~ 28V)
Note: Find additional explanation of operating range in Supplement section

Other Ratings

Contact Resistance: 100 milliohms maximum
Insulation Resistance: 100 megohms minimum @ 500V DC
Dielectric Strength: 500V AC minimum for 1 minute minimum
Mechanical Life: 30,000 cycles minimum
Electrical Life: 10,000 cycles minimum
Nominal Operating Torque: 0.02Nm (0.177 lb•in)
Contact Timing: Nonshorting
Indexing: 45° for 3-position, 4-position & 5-position

Materials & Finishes

Housing: Glass fiber reinforced polyester (PBT)
Base: Glass fiber reinforced polyamide
Rotor: Polyacetal
Movable Contactor: Beryllium copper with gold plating
Stationary Contacts: Phosphor bronze with gold plating
Terminals: Phosphor bronze with gold plating
Mounting Bracket: Steel with tin plating

Environmental Data

Operating Temperature Range: -25°C through +70°C (-13°F through +158°F)
Humidity: 90 ~ 95% humidity for 96 hours @ 40°C (104°F)
Vibration: 10 ~ 55Hz with peak-to-peak amplitude of 1.5mm traversing the frequency range & returning in 1 minute; 3 right angled directions for 2 hours
Shock: 50G (490m/s²) acceleration (tested in 6 right angled directions, with 5 shocks in each direction)

PCB Processing

Soldering: Wave Soldering Recommended: Preheat temperature 110°C; Preheat time 40 seconds; Peak Temperature 270°C; Peak Time 6 seconds; Thickness of PCB 1.6mm; 2 Cycles.
Manual Soldering Recommended: Temperature 390°C for 4 seconds, 2 cycles.
Cleaning: Automated cleaning. See Cleaning Specifications in Supplement section.

Standards & Certifications

The NR01 Series rotaries have not been tested for UL recognition or CSA certification. These switches are designed for use in a low-voltage, low-current, logic-level circuit. When used as intended in a logic-level circuit, the results do not produce hazardous energy.

Note: Values are determined by NKK's individual specification tests in a controlled environment, and do not certify that the product supports simultaneous multiple conditions.

Distinctive Characteristics

Totally sealed construction with internal o-ring, gasket between base and housing, and insert-molded terminals, gives protection for automated processing techniques.

Detent mechanism, with its spring-operated steel ball, gives distinct feel and crisp actuation for accurate switch setting.

Subminiature size and compact body contributes to high density mounting.

Bifurcated, self-wiping contact mechanism provides unequalled logic-level reliability and smoother, positive detent actuation.

Crimped bracket legs ensure secure PCB mounting and prevent dislodging during automated wave soldering.

Molded-in terminals prevent entry of flux and other contaminants.

.100" x .100" (2.54mm x 2.54mm) terminal spacing conforms to standard PC board grid spacing.

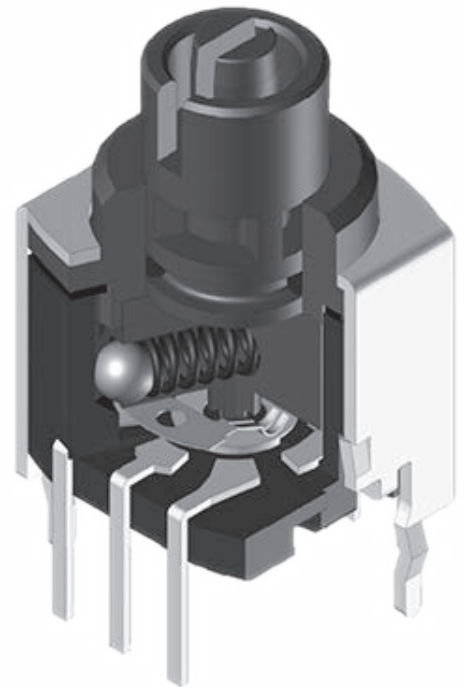

Applications

- Power Control Equipment
- Measuring Devices
- Telecommunication Equipment
- Medical Equipment
- Teaching Pendant

Actual Size

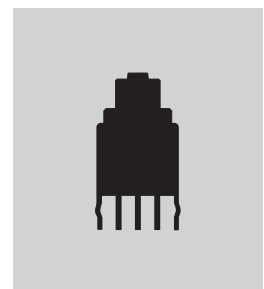

TYPICAL SWITCH ORDERING EXAMPLE

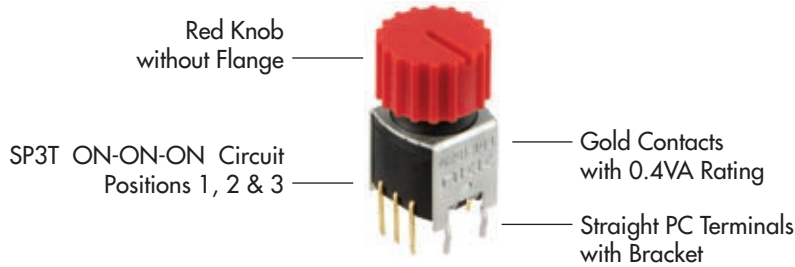
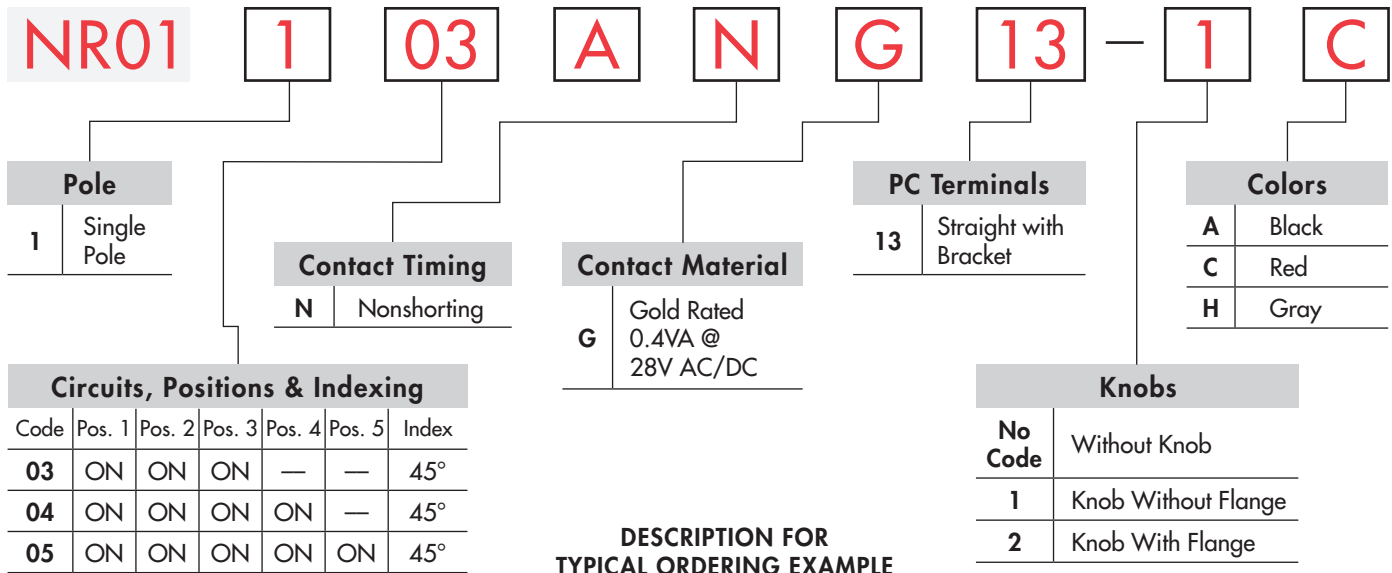

POLES & CIRCUITS

Pole	Model	Actuator Positions					Connected Terminals					Throw & Schematics
		Pos 1	Pos 2	Pos 3	Pos 4	Pos 5	Pos 1	Pos 2	Pos 3	Pos 4	Pos 5	
SP3T	NR01103	ON	ON	ON	—	—	C-2	C-3	C-4	—	—	
SP4T	NR01104	ON	ON	ON	ON	—	C-2	C-3	C-4	C-5	—	
SP5T	NR01105	ON	ON	ON	ON	ON	C-1	C-2	C-3	C-4	C-5	

Note: Terminal numbers are not actually on switch

CONTACT MATERIAL & RATING

G Gold over Bronze or Copper
Logic Level
0.4VA @ 28V AC/DC maximum

TERMINALS

13 Straight PC with Bracket

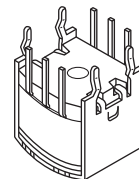

TYPICAL SWITCH DIMENSIONS

45° Indexing • SP3T • Straight PC

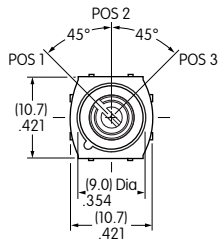

Actuator shown in Position 1

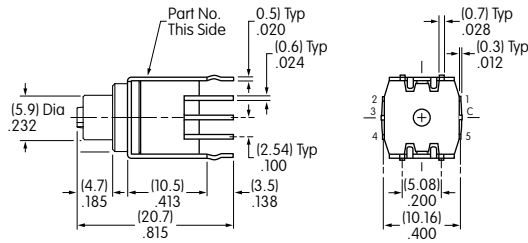

Terminals 1 & 5 are support pins

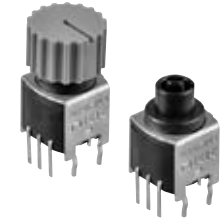
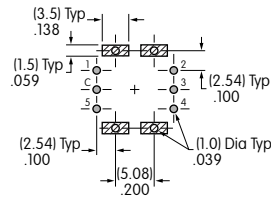

NR01103ANG13-1C

45° Indexing • SP4T • Straight PC

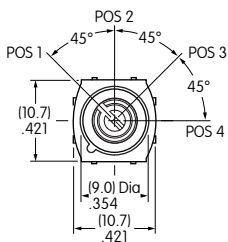

Actuator shown in Position 1

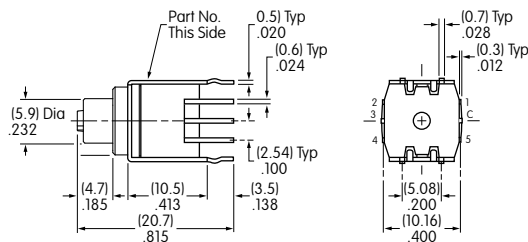

Terminal 1 is a support pin

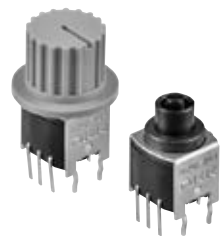
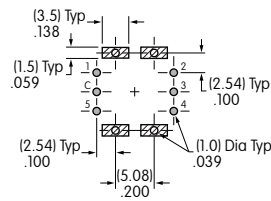

NR01104ANG13-2C

45° Indexing • SP5T • Straight PC

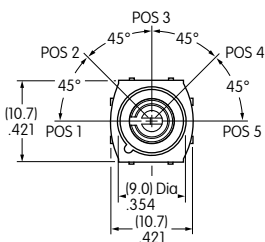

Actuator shown in Position 1

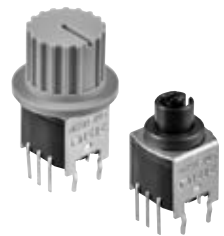
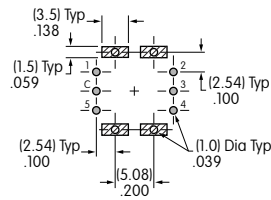
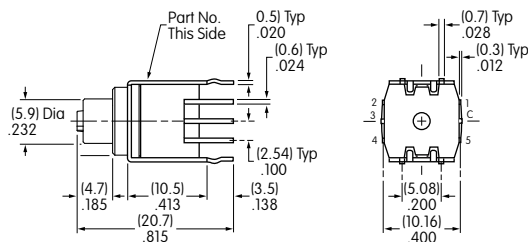

NR01105ANG13-2C

KNOBS

No Code

Without Knob

1 AT3008 Without Flange

Material:
Glass fiber reinforced polyamide

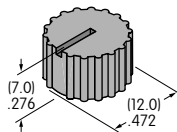

2 AT3009 With Flange

Material:
Glass fiber reinforced polyamide

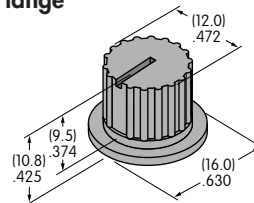

Knob Colors

- A** Black
- C** Red
- H** Gray

MOUNTING & INSTALLATION

Knob Installation

To prevent knob from disassembling from the switch, it is recommended to use the type with a flange. Mount the knob with the flange (AT3009, assembled to switch) beneath the panel, as shown in illustration.

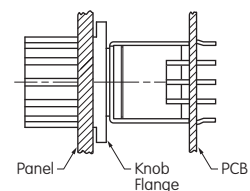

Ideal for Applications that Require Small Sizes with Precision & Reliability

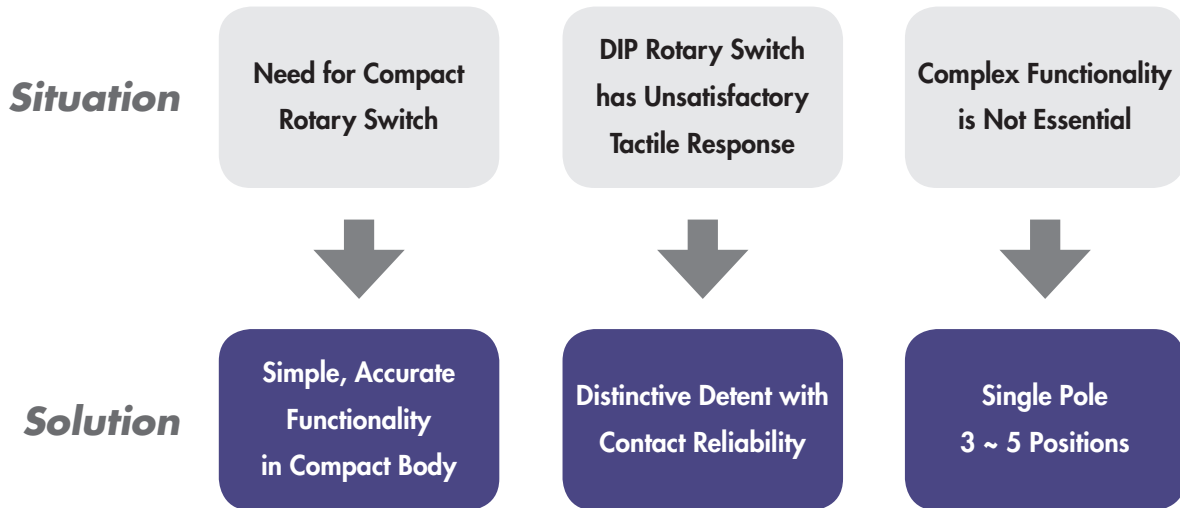

Advantages

- Simplified soldering and automated cleaning processes enhance production efficiency
- Reinforced bracket with crimped legs improves mounting stability and strength
- Easy, straightforward functionality
- Small, subminiature size with precise detent and crisp actuation

Typical Applications



Switching Function

F1, F2, F3, F4

Handheld Automation Devices



Input Switching





AC, DC, GND

Signal Mode Selection

CH1, CH2, DUAL

Measuring Devices

A Comprehensive Line of Rotary Switches Meets a Variety of Applications

PCB Mount Rotaries	NR01	MRB	MRA112	FR01
Specifications				
Number of Poles	1	1	1, 2, 4	—
Positions	3, 4, 5	2, 3	2 ~ 12	—
Electrical Capacity	0.4VA Max @ 28V AC/DC Max	0.4VA Max @ 28V AC/DC Max	250mA @ 125V AC	100mA @ 5V DC
Electrical Life	10,000 Operations Min	10,000 Operations Min	10,000 Operations Min	10,000 Detent Operations Min
Operating Temperature	-25 ~ +70°C (-13 ~ +158°F)	-10 ~ +70°C (+14 ~ +158°F)	-10 ~ +70°C (+14 ~ +158°F)	-25 ~ +85°C (-13 ~ +185°F)
External Dimensions	10.7 x 10.7mm (.421 x .421")	14.5 x 15.74mm (.571 x .620")	16mm Dia (.630" Dia)	10.0 x 10.0mm (.394 x .394")
Process Sealed	Yes	Yes	Yes	No

Subminiature & Ultra-Miniature DIP Rotaries

FR01



- 10mm
- Ultra-Thin
- 100mA @ 5/50V DC
- Subminiature

ND



- 8mm
- Process Sealed
- 100mA @ 5/50V DC
- Ultra-Miniature

SMT DIP Rotaries

FR02



- 10mm
- Ultra-Thin
- 100mA @ 5/50V DC
- Subminiature

ND3



- 8mm
- Process Sealed
- 100mA @ 5/50V DC
- Ultra-Miniature

Miniature & Subminiature Rotaries

NR01



- Process Sealed
- Positive Detent
- 0.4VA @ 28V AC/DC
- Subminiature

MRX



- Positive Detent
- Metal Bushing & Housing
- 1A @ 30V DC
- Miniature

MRB



- Process Sealed
- IP67 Rated
- 0.4VA @ 28V AC/DC
- Miniature

Standard Rotaries with Multiple Positions & Poles

HS13



- 6A @ 125V AC
- 10mm Bushing

TS



- 6A @ 125/250V AC
- 10mm Bushing

HS16



- 12A @ 125V AC
- 10mm Bushing

PS



- 30A @ 125/250V AC
- 10mm Bushing

NKK offers optional knobs for Rotary Switches. See Accessories or contact our Sales Department.

Effective Date July 2017



http://www.nkkswitches.com • 1.877.2BUYNKK (228.9655)
7850 East Gelding Drive • Scottsdale, AZ 85260 • Telephone 480.991.0942 • Fax 480.998.1435

