



Parameter	Ratings	Units
Blocking Voltage	600	V_P
Load Current	300	mA_{rms}
On State Voltage Drop	2.5	V_{rms} (at $I_L = 300 mA_{rms}$)
Operating Voltage	240	V_{rms}

Features

- Load Current up to $300 mA_{rms}$
- $600V_P$ Blocking Voltage
- 5mA Sensitivity
- Zero-Crossing Detection
- DC Control, AC Output
- Optically Isolated
- TTL and CMOS Compatible
- Low EMI and RFI Generation
- High Noise Immunity
- Machine Insertable, Wave Solderable

Applications

- Triac Driver
- Programmable Control
- Process Control
- Power Control Panels
- Remote Switching
- Gas Pump Electronics
- Contactors
- Large Relays
- Solenoids
- Motors
- Heaters

Description

The CPC1962 is an AC Solid State Switch using optical coupling with dual integrated SCR outputs to produce an ideal isolated triac driver. The CPC1962 switches are robust enough to provide a blocking voltage of up to $600V_P$. In addition, tightly controlled zero cross circuitry ensures switching of AC loads without the generation of transients.

The input and output circuits are optically coupled to provide $3750V_{rms}$ of isolation and noise immunity between the control and load circuits. As a result the CPC1962 is well suited for industrial environments where electromagnetic interference could disrupt the operation of electromechanical relays.

Approvals

- UL recognized file #: E69938

Ordering Information

Part #	Description
CPC1962G	6-Pin DIP (50/Tube)
CPC1962GS	6-Pin Surface Mount (50/Tube)
CPC1962GSTR	6-Pin Surface Mount (1000/Reel)

Pin Configuration

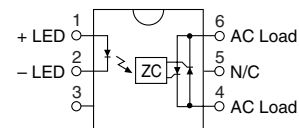

Absolute Maximum Ratings

Parameter	Ratings	Units
Blocking Voltage	600	V_P
Reverse Input Voltage	5	V
Input Control Current	50	mA
Peak (10ms)	1	A
Input Power Dissipation ¹	150	mW
Total Package Dissipation ²	800	mW
Isolation Voltage Input to Output	3750	V_{rms}
Operational Temperature	-40 to +85	°C
Storage Temperature	-40 to +125	°C

¹ Derate Linearly 1.33 mW/°C

² Derate Linearly 6.67 mW/°C

Electrical absolute maximum ratings are at 25°C

Absolute Maximum Ratings are stress ratings. Stresses in excess of these ratings can cause permanent damage to the device. Functional operation of the device at conditions beyond those indicated in the operational sections of this data sheet is not implied.

Electrical Characteristics

Parameters	Conditions	Symbol	Min	Typ	Max	Units
Output Characteristics @ 25°C						
Operating Voltage	-	V_L	5	-	240	V_{rms}
Load Current, Continuous	-	I_L	5	-	300	mA_{rms}
Off State Leakage Current	$V_L = 600V$	I_{LEAK}	-	-	1	μA
On-State Voltage Drop	$I_L = 300mA_{rms}$	V_{ON}	-	-	2.5	V_{rms}
Critical Rate of Rise	-	dv/dt	500	-	-	V/ μs
Holding Current	$I_F = 5mA$	I_H	-	200	-	μA
Switching Speeds						
Turn-on	$I_F = 5mA$	T_{ON}	-	-	0.5	cycles
Turn-off	$I_F = 5mA$	T_{OFF}	-	-	0.5	cycles
Zero-Cross Turn-On Voltage	1st half cycle	-	-	5	20	V
Sub. half cycle	-	-	-	-	1	V
Operating Frequency ¹	-	-	20	-	500	Hz
Load Power Factor for Guaranteed Turn-On ²	60Hz	PF	0.25	-	-	-
Input Characteristics @ 25°C						
Input Control Current ³	-	I_F	5	-	-	mA
Input Voltage Drop	$I_F = 5mA$	V_F	0.9	1.2	1.4	V
Input Drop-out Voltage	-	-	0.8	-	-	V
Reverse Input Current	$V_R = 5V$	I_R	-	-	10	μA
Common Characteristics @ 25°C						
Input to Output Capacitance	-	$C_{I/O}$	-	3	-	pF

¹ Zero Cross 1st half cycle @ <100Hz

² Snubber circuits may be required at low power factors.

³ For high noise environment use at least 10mA LED Current.

PERFORMANCE DATA*

CPC1962
Typical LED Forward Voltage Drop
(Ambient Temperature = 25°C)
 $I_F = 5\text{mA}_{DC}$

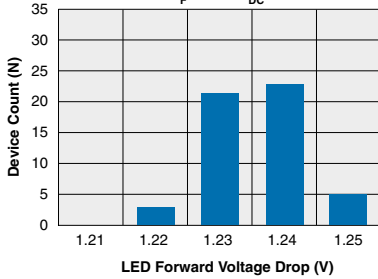

CPC1962
Typical On-State Output
Forward Voltage Distribution
(Ambient Temperature = 25°C)

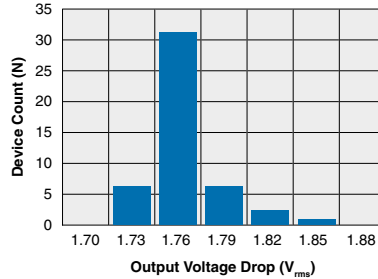

CPC1962
Typical Blocking Voltage Distribution
(Ambient Temperature = 25°C)

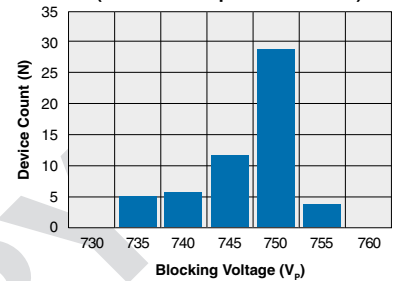

CPC1962
Typical I_F for Switch Operation
(Ambient Temperature = 25°C)

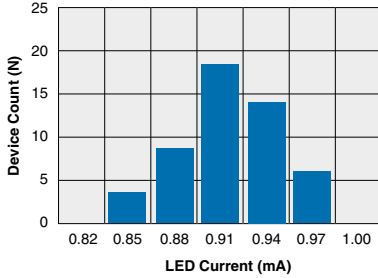

CPC1962
Typical Maximum Load
Current vs. Temperature

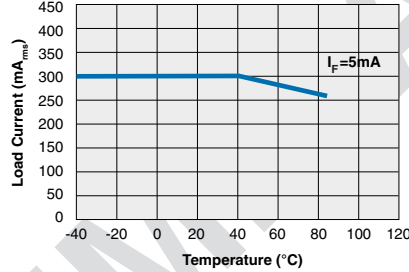

CPC1962
Typical Leakage vs. Temperature
@ Maximum Rated Load Voltage

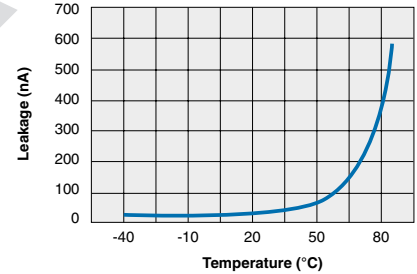

CPC1962
Typical Blocking Voltage
vs. Temperature

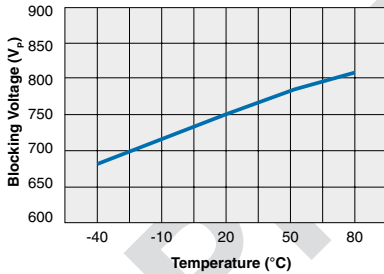

CPC1962
Typical Output Voltage Drop
vs. Temperature

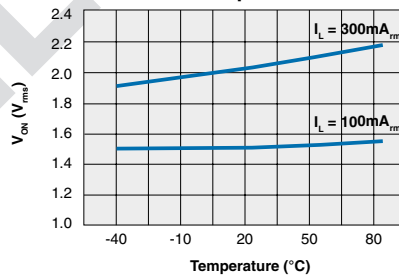

CPC1962
Typical LED Forward Voltage Drop
vs. Temperature

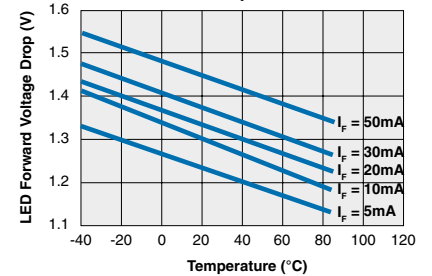

CPC1962
Typical I_F for Switch Operation
vs. Temperature

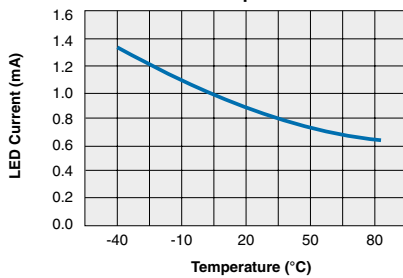

CPC1962
Maximum Surge Current (non-repetitive)
($T_J = 50^{\circ}\text{C}$ max)

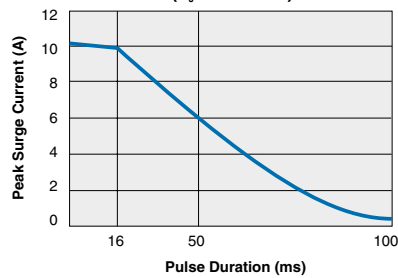

*The Performance data shown in the graphs above is typical of device performance. For guaranteed parameters not indicated in the written specifications, please contact our application department.

Manufacturing Information

Soldering

Recommended soldering processes are limited to 260°C component body temperature for 10 seconds.



Washing

Clare does not recommend ultrasonic cleaning or the use of chlorinated solvents.

MECHANICAL DIMENSIONS

6-Pin DIP Through Hole (Standard)

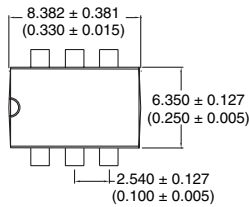
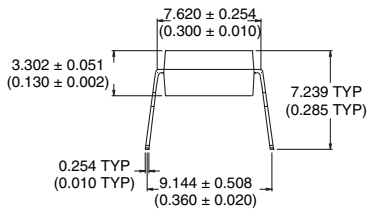

PC Board Pattern (Top View)

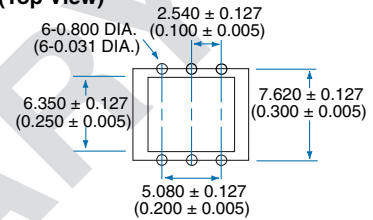

6-Pin Surface Mount ("S" Suffix)

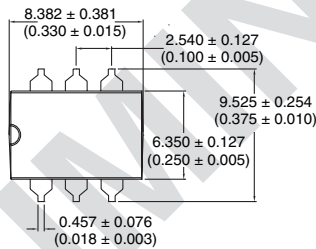
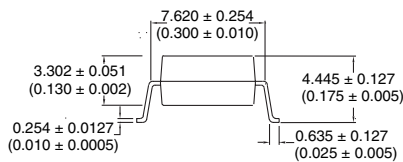

PC Board Pattern (Top View)

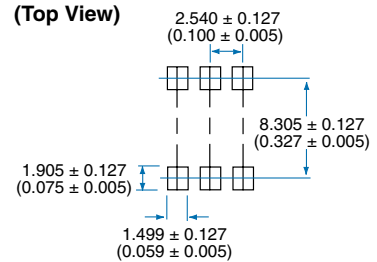

Tape and Reel Packaging for Surface Mount Package

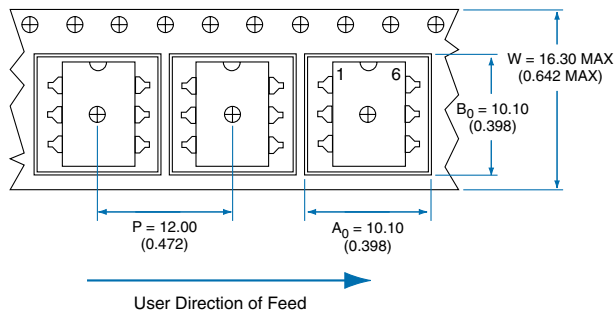
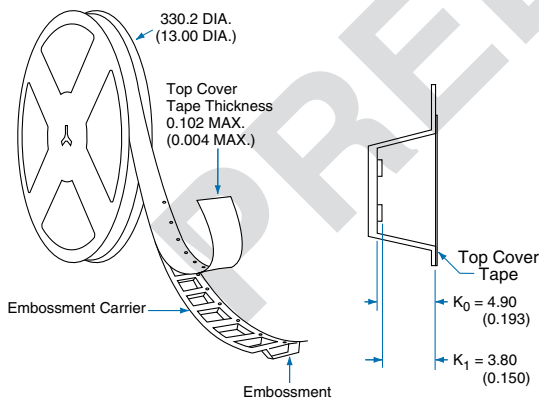

Dimensions:
mm
(inches)

For additional information please visit our website at: www.clare.com

Clare, Inc. makes no representations or warranties with respect to the accuracy or completeness of the contents of this publication and reserves the right to make changes to specifications and product descriptions at any time without notice. Neither circuit patent licenses nor indemnity are expressed or implied. Except as set forth in Clare's Standard Terms and Conditions of Sale, Clare, Inc. assumes no liability whatsoever, and disclaims any express or implied warranty, relating to its products including, but not limited to, the implied warranty of merchantability, fitness for a particular purpose, or infringement of any intellectual property right.

The products described in this document are not designed, intended, authorized or warranted for use as components in systems intended for surgical implant into the body, or in other applications intended to support or sustain life, or where malfunction of Clare's product may result in direct physical harm, injury, or death to a person or severe property or environmental damage. Clare, Inc. reserves the right to discontinue or make changes to its products at any time without notice.