



MCP73861/2/3/4

Advanced Single or Dual Cell, Fully Integrated Li-Ion/Li-Polymer Charge Management Controllers

Features:

- Linear Charge Management Controllers:
 - Integrated Pass Transistor
 - Integrated Current Sense
 - Reverse-Blocking Protection
- High-Accuracy Preset Voltage Regulation: $\pm 0.5\%$
- Four Selectable Voltage Regulation Options:
 - 4.1V, 4.2V – **MCP73861/3**
 - 8.2V, 8.4V – **MCP73862/4**
- Programmable Charge Current: 1.2A Maximum
- Programmable Safety Charge Timers
- Preconditioning of Deeply Depleted Cells
- Automatic End-of-Charge Control
- Optional Continuous Cell Temperature Monitoring
- Charge Status Output for Direct LED Drive
- Fault Output for Direct LED Drive
- Automatic Power-Down
- Thermal Regulation
- Temperature Range: -40°C to $+85^{\circ}\text{C}$
- Packaging: 16-Pin, 4 x 4 QFN
16-Pin SOIC

Applications:

- Lithium-Ion/Lithium-Polymer Battery Chargers
- Personal Data Assistants (PDAs)
- Cellular Telephones
- Hand-Held Instruments
- Cradle Chargers
- Digital Cameras
- MP3 Players

Description:

The MCP7386X family of devices features highly advanced linear charge management controllers for use in space-limited, cost-sensitive applications. The devices combine high-accuracy, constant voltage and current regulation, cell preconditioning, cell temperature monitoring, advanced safety timers, automatic charge termination, internal current sensing, reverse-blocking protection, charge status and fault indication in either a space-saving 16-pin 4 x 4 QFN package, or a 16-pin SOIC package. The MCP7386X provides a complete, fully functional, stand-alone charge management solution with a minimum number of external components.

The MCP73861/3 is intended for applications utilizing single-cell Lithium-Ion or Lithium-Polymer battery packs, while the MCP73862/4 is intended for dual series cell Lithium-Ion or Lithium-Polymer battery packs. The MCP73861/3 has two selectable voltage-regulation options available (4.1V and 4.2V), for use with either coke or graphite anodes and operate with an input voltage range of 4.5V to 12V. The MCP73862/4 has two selectable voltage-regulation options available (8.2V and 8.4V), for use with coke or graphite anodes, and operate with an input voltage range of 8.7V to 12V.

The MCP73861/2 and MCP73863/4 differ only in the function of the charge status output (STAT1) when a charge cycle has been completed. The MCP73861/2 flashes the output, while the MCP73863/4 turns the output off. Refer to [Section 5.2.1 “Charge Status Outputs \(STAT1, STAT2\)”](#).

The MCP7386X family of devices are fully specified over the ambient temperature range of -40°C to $+85^{\circ}\text{C}$.

MCP73861/2/3/4

Package Types

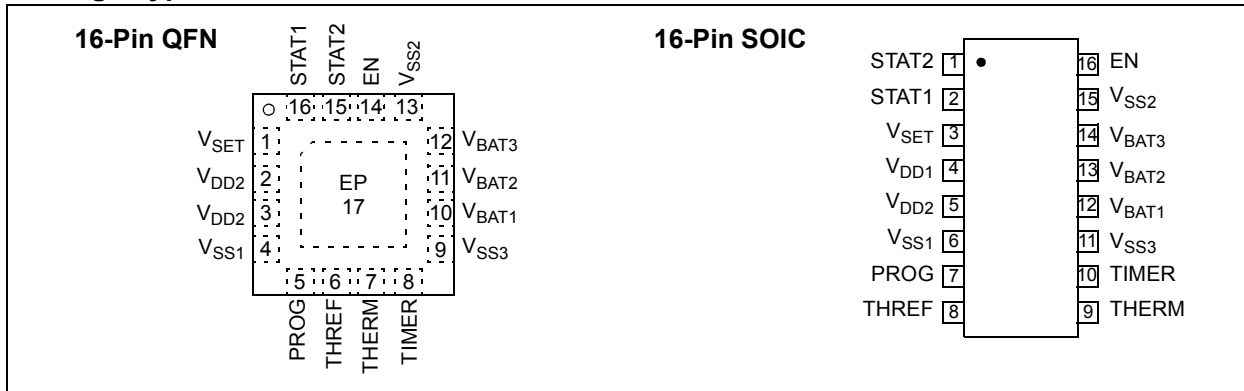

Typical Application

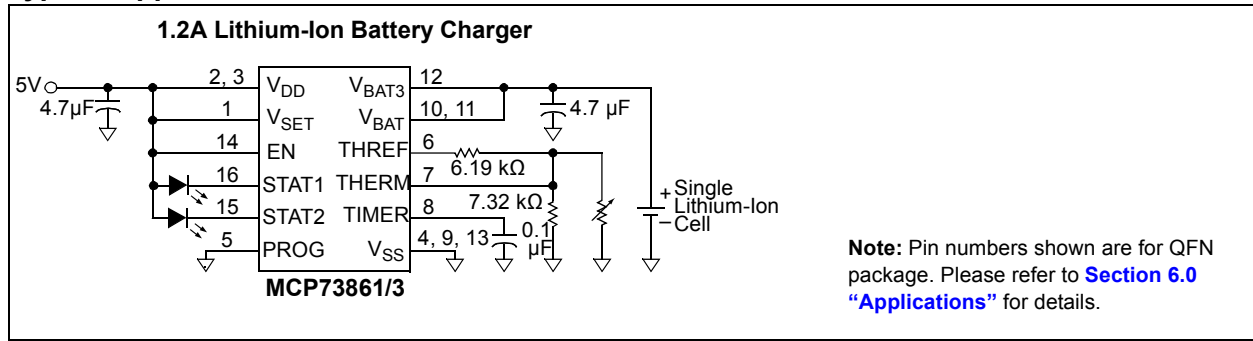

Functional Block Diagram

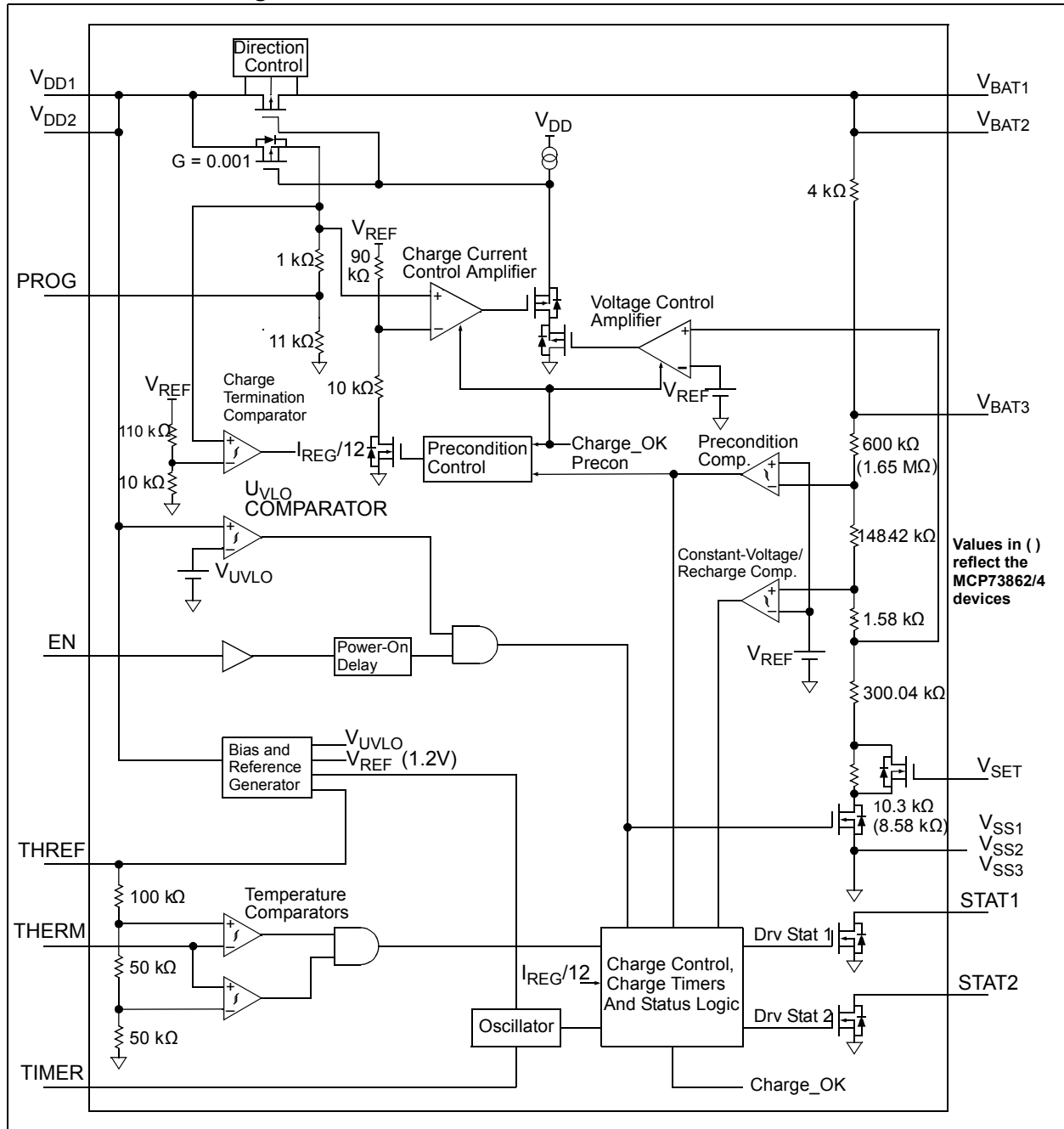

MCP73861/2/3/4

1.0 ELECTRICAL CHARACTERISTICS

Absolute Maximum Ratings†

V_{DDN}	13.5V
V_{BATN} , V_{SET} , EN, STAT1, STAT2 w.r.t. V_{SS}	-0.3 to ($V_{DD} + 0.3$)V
PROG, THREF, THERM, TIMER w.r.t. V_{SS}	-0.3 to 6V
Maximum Junction Temperature, T_J	Internally Limited
Storage temperature	-65°C to +150°C
ESD protection on all pins:	
Human Body Model (1.5 k Ω in series with 100 pF)....	≥ 4 kV
Machine Model (200 pF, No series resistance)	300V

† **Notice:** Stresses above those listed under “Maximum Ratings” may cause permanent damage to the device. This is a stress rating only and functional operation of the device at those or any other conditions above those indicated in the operational listings of this specification is not implied. Exposure to maximum rating conditions for extended periods may affect device reliability.

DC CHARACTERISTICS

Electrical Specifications: Unless otherwise indicated, all limits apply for $V_{DD} = [V_{REG}(typ.) + 0.3V]$ to 12V, $T_A = -40^\circ\text{C}$ to $+85^\circ\text{C}$. Typical values are at $+25^\circ\text{C}$, $V_{DD} = [V_{REG}(typ.) + 1.0V]$

Parameters	Sym.	Min.	Typ.	Max.	Units	Conditions
Supply Input						
Supply Voltage	V_{DD}	4.5	—	12	V	MCP73861/3
		8.7	—	12	V	MCP73862/4
Supply Current	I_{SS}	—	0.17	4	μA	Disabled
		—	0.53	4	mA	Operating
UVLO Start Threshold	V_{START}	4.25	4.5	4.65	V	MCP73861/3
		8.45	8.8	9.05	V	MCP73862/4 V_{DD} Low-to-High
UVLO Stop Threshold	V_{STOP}	4.20	4.4	4.55	V	MCP73861/3
		8.40	8.7	8.95	V	MCP73862/4 V_{DD} High-to-Low
Voltage Regulation (Constant-Voltage Mode)						
Regulated Output Voltage	V_{REG}	4.079	4.1	4.121	V	MCP73861/3 , $V_{SET} = V_{SS}$
		4.179	4.2	4.221	V	MCP73861/3 , $V_{SET} = V_{DD}$
		8.159	8.2	8.241	V	MCP73862/4 , $V_{SET} = V_{SS}$
		8.358	8.4	8.442	V	MCP73862/4 , $V_{SET} = V_{DD}$
$V_{DD} = [V_{REG}(typ.) + 1V]$, $I_{OUT} = 10$ mA $T_A = -5^\circ\text{C}$ to $+55^\circ\text{C}$						
Line Regulation	$ \Delta V_{BAT} / V_{BAT} / \Delta V_{DD}$	—	0.025	0.25	%/V	$V_{DD} = [V_{REG}(typ.) + 1V]$ to 12V $I_{OUT} = 10$ mA
Load Regulation	$ \Delta V_{BAT} / V_{BAT} $	—	0.01	0.25	%	$I_{OUT} = 10$ mA to 150 mA $V_{DD} = [V_{REG}(typ.) + 1V]$
Supply Ripple Attenuation	PSRR	—	60	—	dB	$I_{OUT} = 10$ mA, 10 Hz to 1 kHz
		—	42	—	dB	$I_{OUT} = 10$ mA, 10 Hz to 10 kHz
		—	28	—	dB	$I_{OUT} = 10$ mA, 10 Hz to 1 MHz
Output Reverse Leakage Current	$I_{DISCHARGE}$	—	0.23	1	μA	$V_{DD} < V_{BAT} = V_{REG}(typ.)$, $V_{DD} = 1.5$ k Ω to Ground
Output Reverse Leakage Switchover Time	$I_{DISCHARGE_SW}$	—	0	1000	ms	$V_{DD} < V_{BAT}$, $V_{DD} \leq 1.5$ k Ω to Ground

DC CHARACTERISTICS (CONTINUED)

Electrical Specifications: Unless otherwise indicated, all limits apply for $V_{DD} = [V_{REG}(typ.) + 0.3V]$ to 12V, $T_A = -40^\circ C$ to $+85^\circ C$. Typical values are at $+25^\circ C$, $V_{DD} = [V_{REG}(typ.) + 1.0V]$						
Parameters	Sym.	Min.	Typ.	Max.	Units	Conditions
Current Regulation (Fast Charge Constant-Current Mode)						
Fast Charge Current Regulation	I_{REG}	85	100	115	mA	PROG = OPEN
		1020	1200	1380	mA	PROG = V_{SS}
		425	500	575	mA	PROG = 1.6 k Ω $T_A = -5^\circ C$ to $+55^\circ C$
Preconditioning Current Regulation (Trickle Charge Constant-Current Mode)						
Precondition Current Regulation	I_{PREG}	5	10	15	mA	PROG = OPEN
		60	120	180	mA	PROG = V_{SS}
		25	50	75	mA	PROG = 1.6 k Ω $T_A = -5^\circ C$ to $+55^\circ C$
Precondition Threshold Voltage	V_{PTH}	2.70	2.80	2.90	V	MCP73861/3 , $V_{SET} = V_{SS}$
		2.75	2.85	2.95	V	MCP73861/3 , $V_{SET} = V_{DD}$
		5.40	5.60	5.80	V	MCP73862/4 , $V_{SET} = V_{SS}$
		5.50	5.70	5.90	V	MCP73862/4 , $V_{SET} = V_{DD}$ V_{BAT} Low-to-High
Charge Termination						
Charge Termination Current	I_{TERM}	6	8.5	11	mA	PROG = OPEN
		70	90	120	mA	PROG = V_{SS}
		32	41	50	mA	PROG = 1.6 k Ω $T_A = -5^\circ C$ to $+55^\circ C$
Automatic Recharge						
Recharge Threshold Voltage	V_{RTH}	$V_{REG} - 300$ mV	$V_{REG} - 200$ mV	$V_{REG} - 100$ mV	V	MCP73861/3
		$V_{REG} - 600$ mV	$V_{REG} - 400$ mV	$V_{REG} - 200$ mV	V	MCP73862/4 V_{BAT} High-to-Low
Thermistor Reference						
Thermistor Reference Output Voltage	V_{THREF}	2.475	2.55	2.625	V	$T_A = 25^\circ C$, $V_{DD} = V_{REG}(typ.) + 1V$, $I_{THREF} = 0$ mA
Thermistor Reference Source Current	I_{THREF}	200	—	—	μA	
Thermistor Reference Line Regulation	$ \frac{\Delta V_{THREF}}{V_{THREF}} / \frac{\Delta V_{DD}}{V_{DD}}$	—	0.1	0.25	%/V	$V_{DD} = [V_{REG}(typ.) + 1V]$ to 12V
Thermistor Reference Load Regulation	$ \frac{\Delta V_{THREF}}{V_{THREF}} $	—	0.01	0.10	%	$I_{THREF} = 0$ mA to 0.20 mA
Thermistor Comparator						
Upper Trip Threshold	V_{T1}	1.18	1.25	1.32	V	
Upper Trip Point Hysteresis	V_{T1HYS}	—	-50	—	mV	
Lower Trip Threshold	V_{T2}	0.59	0.62	0.66	V	
Lower Trip Point Hysteresis	V_{T2HYS}	—	80	—	mV	
Input Bias Current	I_{BIAS}	—	—	2	μA	
Status Indicator – STAT1, STAT2						
Sink Current	I_{SINK}	4	8	12	mA	
Low Output Voltage	V_{OL}	—	200	400	mV	$I_{SINK} = 1$ mA
Input Leakage Current	I_{LK}	—	0.01	1	μA	$I_{SINK} = 0$ mA, $V_{STAT1,2} = 12V$

MCP73861/2/3/4

DC CHARACTERISTICS (CONTINUED)

Electrical Specifications: Unless otherwise indicated, all limits apply for $V_{DD} = [V_{REG}(typ.) + 0.3V]$ to 12V, $T_A = -40^{\circ}C$ to $+85^{\circ}C$. Typical values are at $+25^{\circ}C$, $V_{DD} = [V_{REG}(typ.) + 1.0V]$

Parameters	Sym.	Min.	Typ.	Max.	Units	Conditions
Enable Input						
Input High Voltage Level	V_{IH}	1.4	—	—	V	
Input Low Voltage Level	V_{IL}	—	—	0.8	V	
Input Leakage Current	I_{LK}	—	0.01	1	μA	$V_{ENABLE} = 12V$
Thermal Shutdown						
Die Temperature	T_{SD}	—	155	—	$^{\circ}C$	
Die Temperature Hysteresis	T_{SDHYS}	—	10	—	$^{\circ}C$	

AC CHARACTERISTICS

Electrical Specifications: Unless otherwise indicated, all limits apply for $V_{DD} = [V_{REG}(typ.) + 0.3V]$ to 12V, $T_A = -40^{\circ}C$ to $+85^{\circ}C$. Typical values are at $+25^{\circ}C$, $V_{DD} = [V_{REG}(typ.) + 1.0V]$

Parameters	Sym.	Min.	Typ.	Max.	Units	Conditions
UVLO Start Delay	t_{START}	—	—	5	ms	V_{DD} Low-to-High
Current Regulation						
Transition Time Out of Preconditioning	t_{DELAY}	—	—	1	ms	$V_{BAT} < V_{PTH}$ to $V_{BAT} > V_{PTH}$
Current Rise Time Out of Preconditioning	t_{RISE}	—	—	1	ms	I_{OUT} Rising to 90% of I_{REG}
Fast Charge Safety Timer Period	t_{FAST}	1.1	1.5	1.9	Hours	$C_{TIMER} = 0.1 \mu F$
Preconditioning Current Regulation						
Preconditioning Charge Safety Timer Period	t_{PRECON}	45	60	75	Minutes	$C_{TIMER} = 0.1 \mu F$
Charge Termination						
Elapsed Time Termination Period	t_{TERM}	2.2	3	3.8	Hours	$C_{TIMER} = 0.1 \mu F$
Status Indicators						
Status Output turn-off	t_{OFF}	—	—	200	μs	$I_{SINK} = 1 mA$ to 0 mA
Status Output turn-on	t_{ON}	—	—	200	μs	$I_{SINK} = 0 mA$ to 1 mA

TEMPERATURE SPECIFICATIONS

Electrical Specifications: Unless otherwise indicated, all limits apply for $V_{DD} = [V_{REG}(typ.) + 0.3V]$ to 12V. Typical values are at $+25^{\circ}C$, $V_{DD} = [V_{REG}(typ.) + 1.0V]$

Parameters	Sym.	Min.	Typ.	Max.	Units	Conditions
Temperature Ranges						
Specified Temperature Range	T_A	-40	—	+85	$^{\circ}C$	
Operating Temperature Range	T_J	-40	—	+125	$^{\circ}C$	
Storage Temperature Range	T_A	-65	—	+150	$^{\circ}C$	
Thermal Package Resistances						
Thermal Resistance, 16-lead, 4 mm x 4 mm QFN	θ_{JA}	—	47	—	$^{\circ}C/W$	4-Layer JC51-7 Standard Board, Natural Convection
Thermal Resistance, 16-lead SOIC	θ_{JA}	—	86.1	—	$^{\circ}C/W$	4-Layer JC51-7 Standard Board, Natural Convection

2.0 TYPICAL PERFORMANCE CURVES

Note: The graphs and tables provided following this note are a statistical summary based on a limited number of samples and are provided for informational purposes only. The performance characteristics listed herein are not tested or guaranteed. In some graphs or tables, the data presented may be outside the specified operating range (e.g., outside specified power supply range) and therefore outside the warranted range.

NOTE: Unless otherwise indicated, $V_{DD} = [V_{REG}(typ.) + 1V]$, $I_{OUT} = 10\text{ mA}$ and $T_A = +25^\circ\text{C}$, Constant-voltage mode.

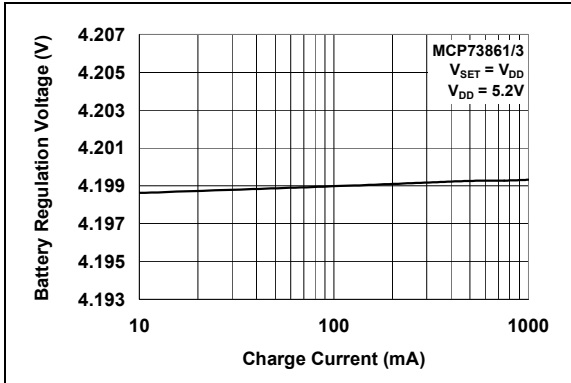

FIGURE 2-1: Battery Regulation Voltage (V_{BAT}) vs. Charge Current (I_{OUT}).

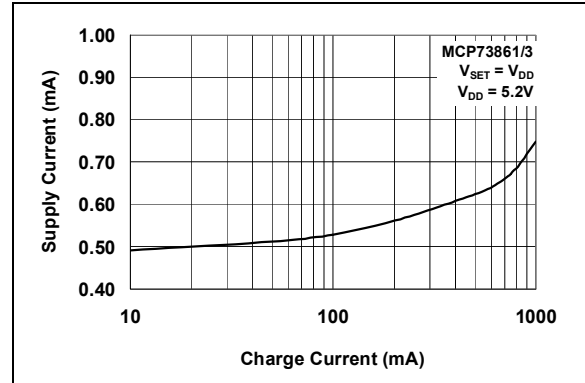

FIGURE 2-4: Supply Current (I_{SS}) vs. Charge Current (I_{OUT}).

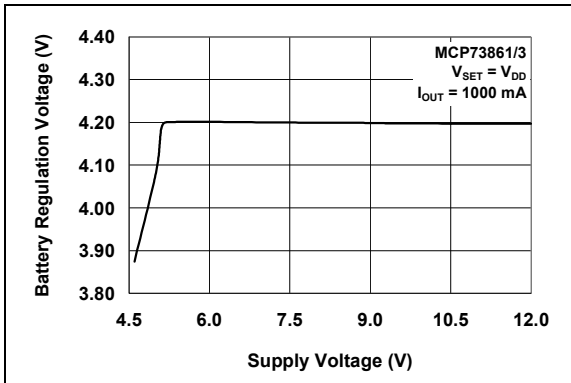

FIGURE 2-2: Battery Regulation Voltage (V_{BAT}) vs. Supply Voltage (V_{DD}).

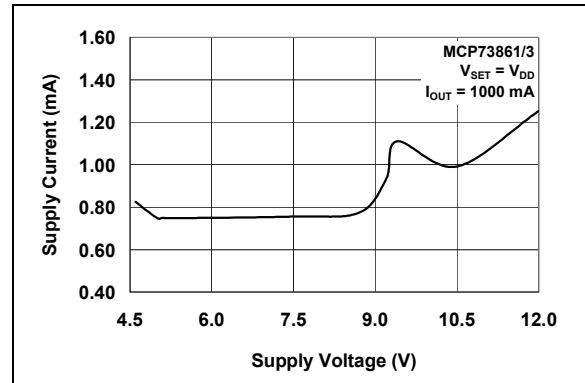

FIGURE 2-5: Supply Current (I_{SS}) vs. Supply Voltage (V_{DD}).

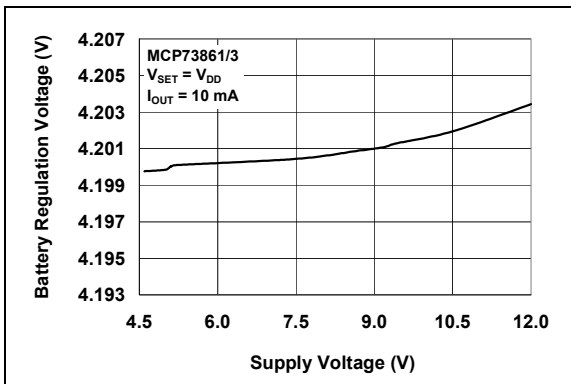

FIGURE 2-3: Battery Regulation Voltage (V_{BAT}) vs. Supply Voltage (V_{DD}).

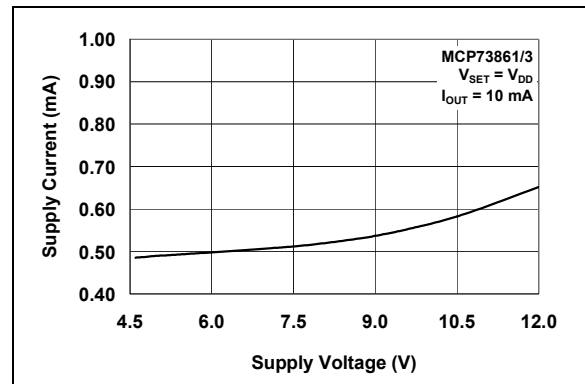

FIGURE 2-6: Supply Current (I_{SS}) vs. Supply Voltage (V_{DD}).

MCP73861/2/3/4

NOTE: Unless otherwise indicated, $V_{DD} = [V_{REG}(typ.) + 1V]$, $I_{OUT} = 10\text{ mA}$ and $T_A = +25^\circ\text{C}$, Constant-voltage mode.

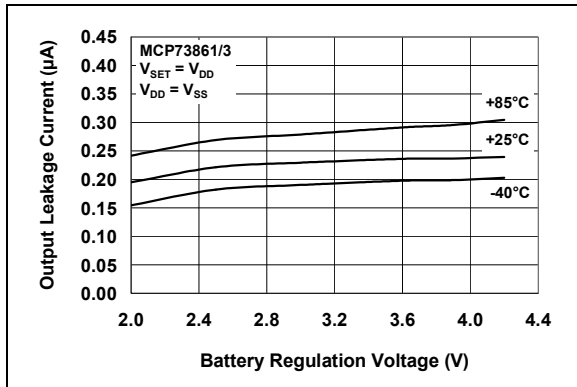

FIGURE 2-7: Output Leakage Current ($I_{DISCHARGE}$) vs. Battery Regulation Voltage (V_{BAT}).

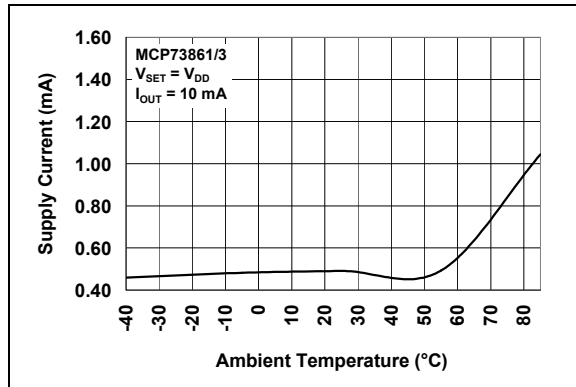

FIGURE 2-10: Supply Current (I_{SS}) vs. Ambient Temperature (T_A).

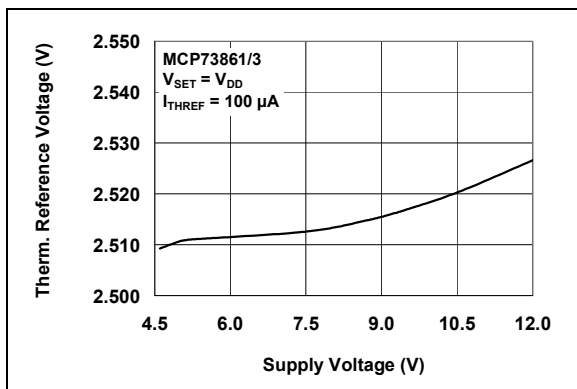

FIGURE 2-8: Thermistor Reference Voltage (V_{THREF}) vs. Supply Voltage (V_{DD}).

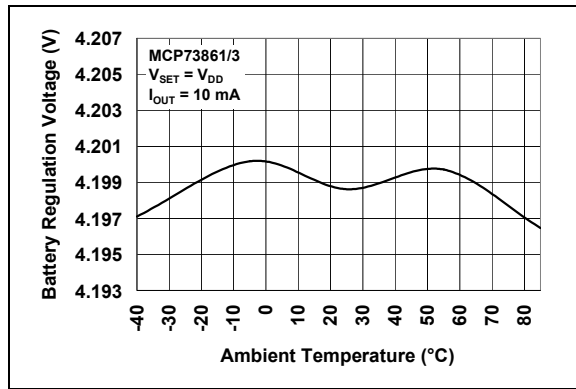

FIGURE 2-11: Battery Regulation Voltage (V_{BAT}) vs. Ambient Temperature (T_A).

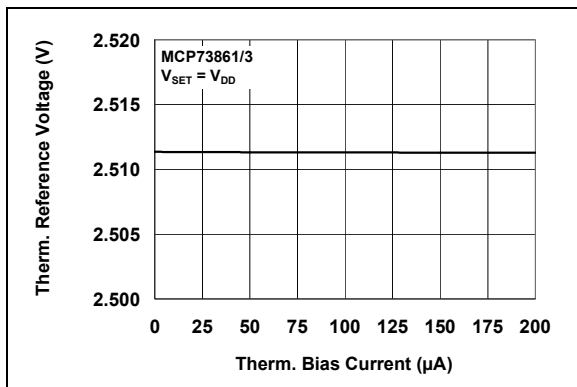

FIGURE 2-9: Thermistor Reference Voltage (V_{THREF}) vs. Thermistor Bias Current (I_{THREF}).

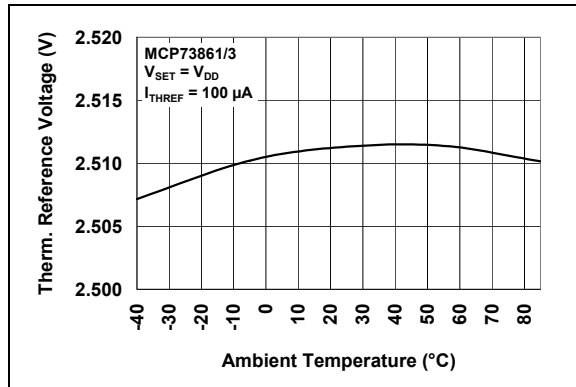

FIGURE 2-12: Thermistor Reference Voltage (V_{THREF}) vs. Ambient Temperature (T_A).

NOTE: Unless otherwise indicated, $V_{DD} = [V_{REG}(typ.) + 1V]$, $I_{OUT} = 10\text{ mA}$ and $T_A = +25^\circ\text{C}$, Constant-voltage mode.

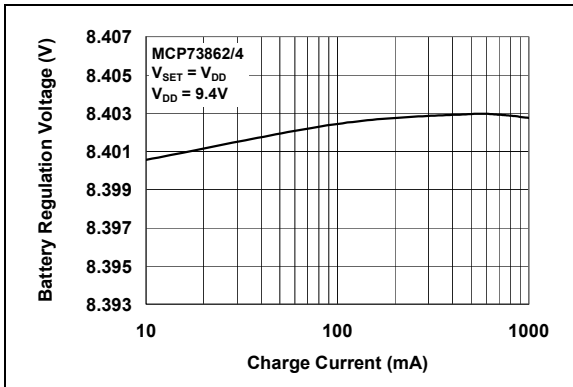

FIGURE 2-13: Battery Regulation Voltage (V_{BAT}) vs. Charge Current (I_{OUT}).

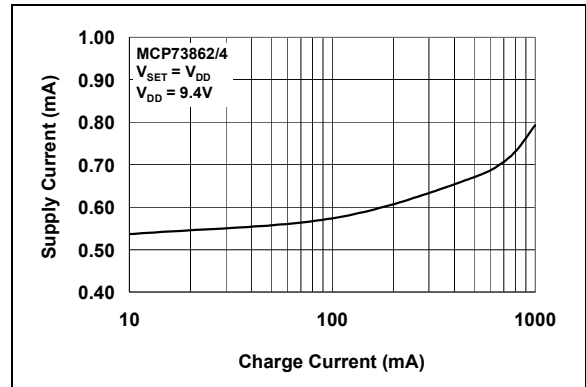

FIGURE 2-16: Supply Current (I_{SS}) vs. Charge Current (I_{OUT}).

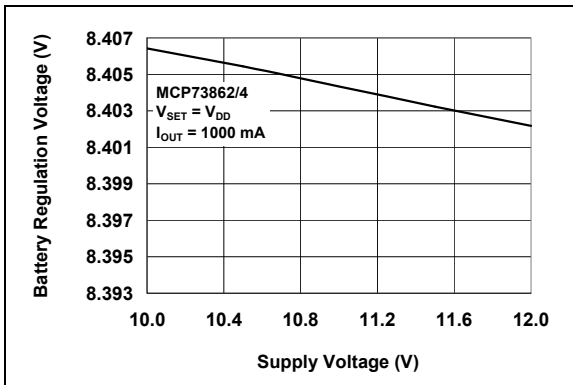

FIGURE 2-14: Battery Regulation Voltage (V_{BAT}) vs. Supply Voltage (V_{DD}).

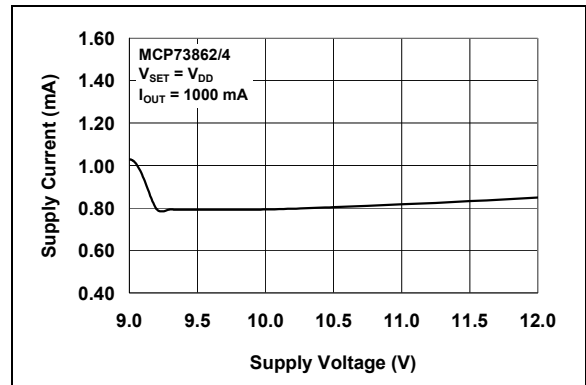

FIGURE 2-17: Supply Current (I_{SS}) vs. Supply Voltage (V_{DD}).

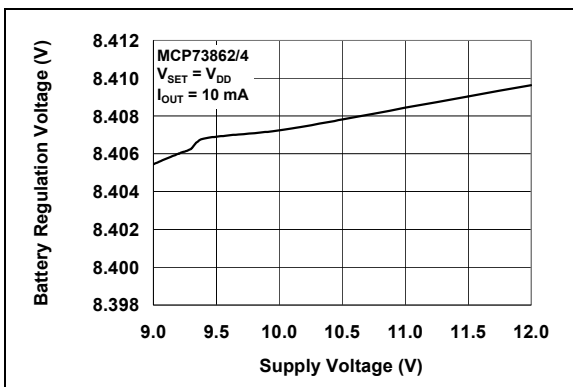

FIGURE 2-15: Battery Regulation Voltage (V_{BAT}) vs. Supply Voltage (V_{DD}).

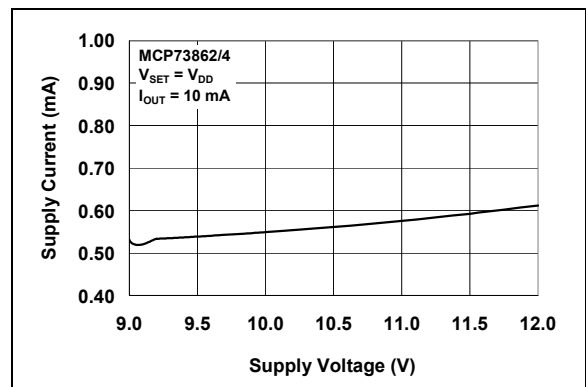

FIGURE 2-18: Supply Current (I_{SS}) vs. Supply Voltage (V_{DD}).

MCP73861/2/3/4

NOTE: Unless otherwise indicated, $V_{DD} = [V_{REG}(typ.) + 1V]$, $I_{OUT} = 10\text{ mA}$ and $T_A = +25^\circ\text{C}$, Constant-voltage mode.

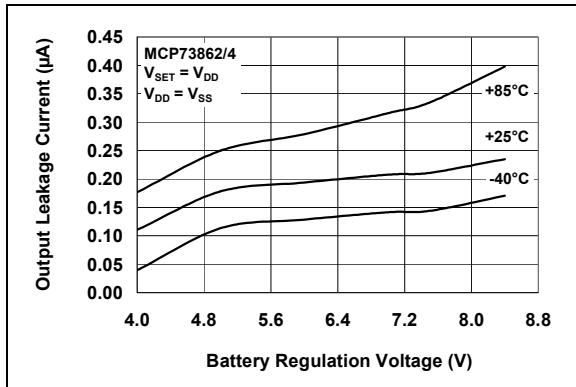

FIGURE 2-19: Output Leakage Current ($I_{DISCHARGE}$) vs. Battery Regulation Voltage (V_{BAT}).

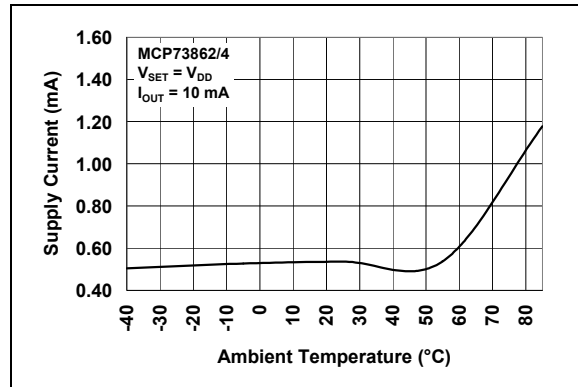

FIGURE 2-22: Supply Current (I_{SS}) vs. Ambient Temperature (T_A).

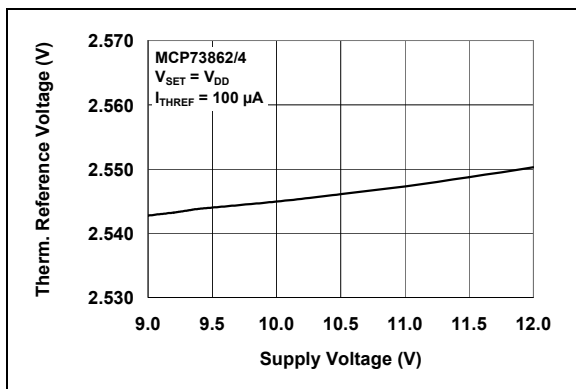

FIGURE 2-20: Thermistor Reference Voltage (V_{THREF}) vs. Supply Voltage (V_{DD}).

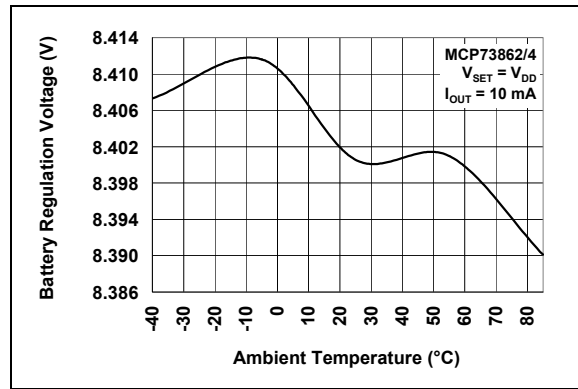

FIGURE 2-23: Battery Regulation Voltage (V_{BAT}) vs. Ambient Temperature (T_A).

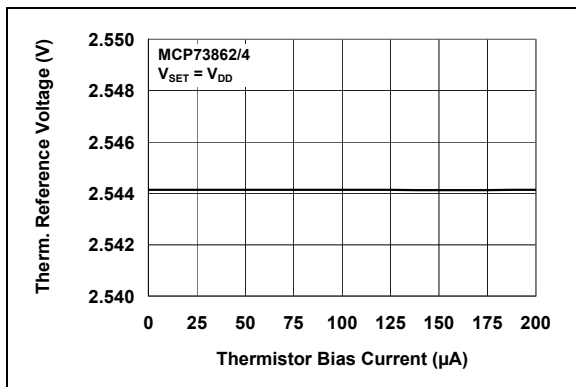

FIGURE 2-21: Thermistor Reference Voltage (V_{THREF}) vs. Thermistor Bias Current (I_{THREF}).

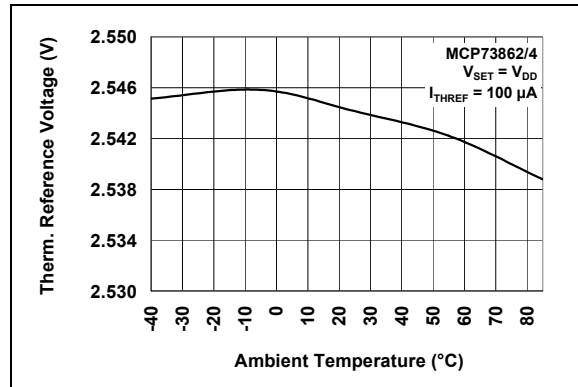

FIGURE 2-24: Thermistor Reference Voltage (V_{THREF}) vs. Ambient Temperature (T_A).

MCP73861/2/3/4

NOTE: Unless otherwise indicated, $V_{DD} = [V_{REG}(typ.) + 1V]$, $I_{OUT} = 10\text{ mA}$ and $T_A = +25^\circ\text{C}$, Constant-voltage mode.

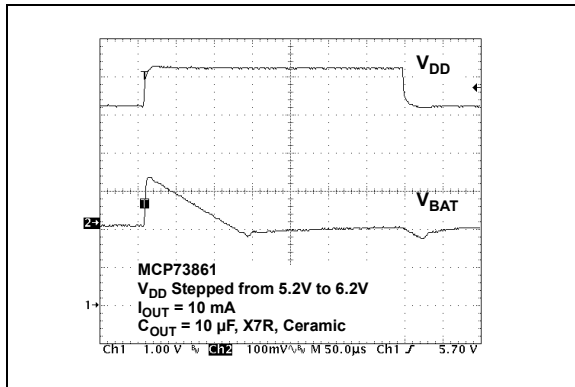

FIGURE 2-25: Line Transient Response.

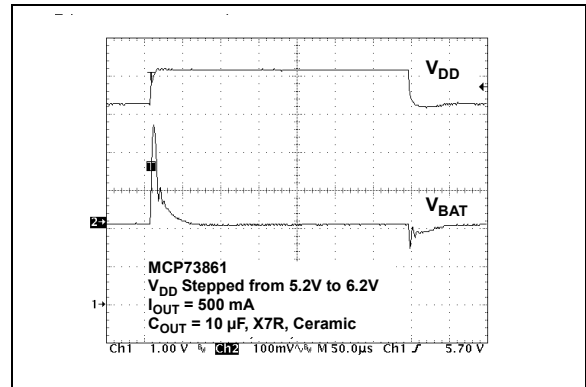

FIGURE 2-28: Line Transient Response.

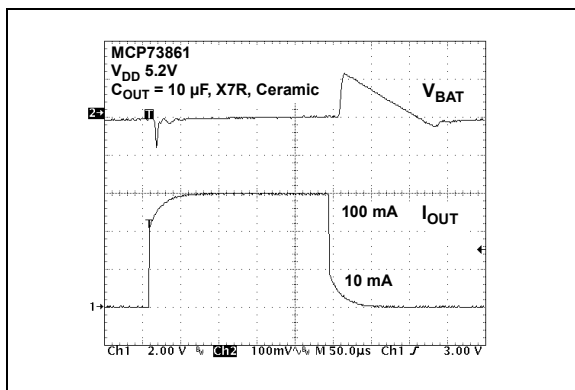

FIGURE 2-26: Load Transient Response.

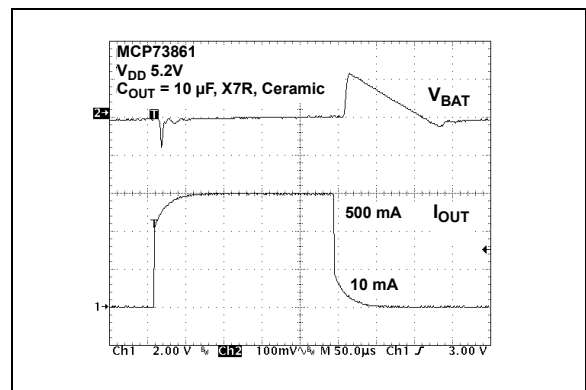

FIGURE 2-29: Load Transient Response.

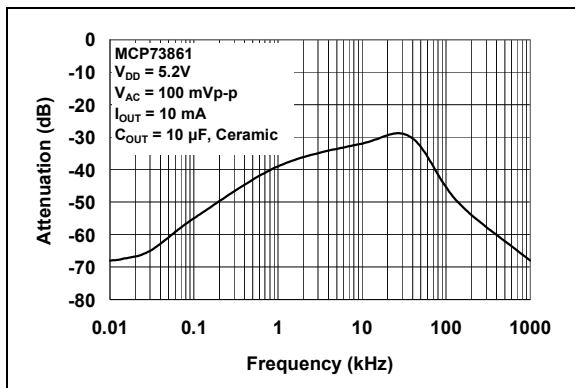

FIGURE 2-27: Power Supply Ripple Rejection.

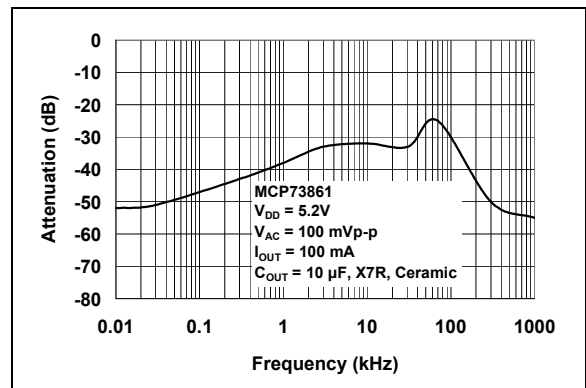

FIGURE 2-30: Power Supply Ripple Rejection.

MCP73861/2/3/4

NOTE: Unless otherwise indicated, $V_{DD} = [V_{REG}(typ.) + 1V]$, $I_{OUT} = 10\text{ mA}$ and $T_A = +25^\circ\text{C}$, Constant-voltage mode.

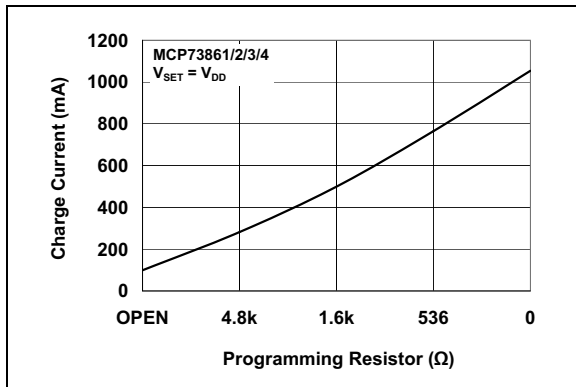

FIGURE 2-31: Charge Current (I_{OUT}) vs. Programming Resistor (R_{PROG}).

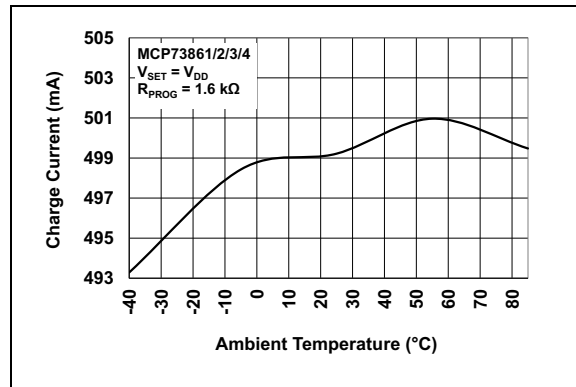

FIGURE 2-32: Charge Current (I_{OUT}) vs. Ambient Temperature (T_A).

3.0 PIN DESCRIPTION

The descriptions of the pins are listed in [Table 3.1](#).

TABLE 3-1: PIN FUNCTION TABLE

MCP73861/2/3/4		Symbol	Function
QFN	SOIC		
1	3	V_{SET}	Voltage Regulation Selection
2	4	V_{DD1}	Battery Management Input Supply
3	5	V_{DD2}	Battery Management Input Supply
4	6	V_{SS1}	Battery Management 0V Reference
5	7	PROG	Current Regulation Set
6	8	THREF	Cell Temperature Sensor Bias
7	9	THERM	Cell Temperature Sensor Input
8	10	TIMER	Timer Set
9	11	V_{SS3}	Battery Management 0V Reference
10	12	V_{BAT1}	Battery Charge Control Output
11	13	V_{BAT2}	Battery Charge Control Output
12	14	V_{BAT3}	Battery Voltage Sense
13	15	V_{SS2}	Battery Management 0V Reference
14	16	EN	Logic Enable
15	1	STAT2	Fault Status Output
16	2	STAT1	Charge Status Output
17	–	EP	Exposed Pad; Battery Management 0V Reference

3.1 Voltage Regulation Selection (V_{SET})

MCP73861/3: Connect V_{SET} to V_{SS} for 4.1V regulation voltage, connect to V_{DD} for 4.2V regulation voltage.

MCP73862/4: Connect V_{SET} to V_{SS} for 8.2V regulation voltage, connect to V_{DD} for 8.4V regulation voltage.

3.2 Battery Management Input Supply (V_{DD2} , V_{DD1})

A supply voltage of $[V_{REG} \text{ (typ.)} + 0.3V]$ to 12V is recommended. Bypass to V_{SS} with a minimum of 4.7 μF . A 1.5 k Ω resistor should be connected from V_{DD} to ground when using disconnectable supplies to force $V_{DD} < V_{BAT}$ when the supply is disconnected and assure low leakage current.

3.3 Battery Management 0V Reference (V_{SS1} , V_{SS2} , V_{SS3})

Connect to negative terminal of battery and input supply.

3.4 Current Regulation Set (PROG)

Preconditioning, fast and termination currents are scaled by placing a resistor from PROG to V_{SS} .

3.5 Cell Temperature Sensor Bias (THREF)

THREF is a voltage reference to bias external thermistor for continuous cell temperature monitoring and prequalification.

3.6 Cell Temperature Sensor Input (THERM)

THERM is an input for an external thermistor for continuous cell-temperature monitoring and prequalification. Connect to THREF/3 to disable temperature sensing.

3.7 Timer Set

All safety timers are scaled by $C_{TIMER}/0.1 \mu F$.

3.8 Battery Charge Control Output (V_{BAT1} , V_{BAT2})

Connect to positive terminal of battery. Drain terminal of internal P-channel MOSFET pass transistor. Bypass to V_{SS} with a minimum of 4.7 μF to ensure loop stability when the battery is disconnected.

3.9 Battery Voltage Sense (V_{BAT3})

V_{BAT3} is a voltage sense input. Connect to positive terminal of battery. A precision internal resistor divider regulates the final voltage on this pin to V_{REG} .

MCP73861/2/3/4

3.10 Logic Enable (EN)

EN is an input to force charge termination, initiate charge, clear faults or disable automatic recharge.

3.11 Fault Status Output (STAT2)

STAT2 is a current-limited, open-drain drive for direct connection to a LED for charge status indication. Alternatively, a pull-up resistor can be applied for interfacing to a host microcontroller.

3.12 Charge Status Output (STAT1)

STAT1 is a current-limited, open-drain drive for direct connection to a LED for charge status indication. Alternatively, a pull-up resistor can be applied for interfacing to a host microcontroller.

3.13 Exposed Pad (EP)

There is an internal electrical connection between the exposed thermal pad and V_{SS} . The EP must be connected to the same potential as the V_{SS} pin on the Printed Circuit Board (PCB).

4.0 DEVICE OVERVIEW

The MCP7386X family of devices are highly advanced linear charge management controllers. Refer to the functional block diagram. [Figure 4-2](#) depicts the operational flow algorithm from charge initiation to completion and automatic recharge.

4.1 Charge Qualification and Preconditioning

Upon insertion of a battery, or application of an external supply, the MCP7386X family of devices automatically performs a series of safety checks to qualify the charge. The input source voltage must be above the Undervoltage Lockout (UVLO) threshold, the enable pin must be above the logic-high level and the cell temperature must be within the upper and lower thresholds. The qualification parameters are continuously monitored. Deviation beyond the limits automatically suspends or terminates the charge cycle. The input voltage must deviate below the UVLO stop threshold for at least one clock period to be considered valid.

Once the qualification parameters have been met, the MCP7386X initiates a charge cycle. The charge status output is pulled low throughout the charge cycle (see [Table 5-1](#) for charge status outputs). If the battery voltage is below the preconditioning threshold (V_{PTH}), the MCP7386X preconditions the battery with a trickle-charge. The preconditioning current is set to approximately 10% of the fast charge regulation current. The preconditioning trickle-charge safely replenishes deeply depleted cells and minimizes heat dissipation during the initial charge cycle. If the battery voltage has not exceeded the preconditioning threshold before the preconditioning timer has expired, a fault is indicated and the charge cycle is terminated.

4.2 Constant Current Regulation – Fast Charge

Preconditioning ends, and fast charging begins, when the battery voltage exceeds the preconditioning threshold. Fast charge regulates to a constant current (I_{REG}), which is set via an external resistor connected to the PROG pin. Fast charge continues until the battery voltage reaches the regulation voltage (V_{REG}), or the fast charge timer expires; in which case, a fault is indicated and the charge cycle is terminated.

4.3 Constant Voltage Regulation

When the battery voltage reaches the regulation voltage (V_{REG}), constant voltage regulation begins. The MCP7386X monitors the battery voltage at the V_{BAT} pin. This input is tied directly to the positive terminal of the battery.

The MCP7386X selects the voltage regulation value based on the state of V_{SET} . With V_{SET} tied to V_{SS} , the MCP73861/3 and MCP73862/4 regulate to 4.1V and 8.2V, respectively. With V_{SET} tied to V_{DD} , the MCP73861/3 and MCP73862/4 regulate to 4.2V and 8.4V, respectively.

4.4 Charge Cycle Completion and Automatic Re-Charge

The MCP7386X monitors the charging current during the Constant-voltage regulation mode. The charge cycle is considered complete when the charge current has diminished below approximately 8% of the regulation current (I_{REG}), or the elapsed timer has expired.

The MCP7386X automatically begins a new charge cycle when the battery voltage falls below the recharge threshold (V_{RTH}), assuming all the qualification parameters are met.

4.5 Thermal Regulation

The MCP7386X family limits the charge current based on the die temperature. Thermal regulation optimizes the charge cycle time while maintaining device reliability. If thermal regulation is entered, the timer is automatically slowed down to ensure that a charge cycle will not terminate prematurely. [Figure 4-1](#) depicts the thermal regulation profile.

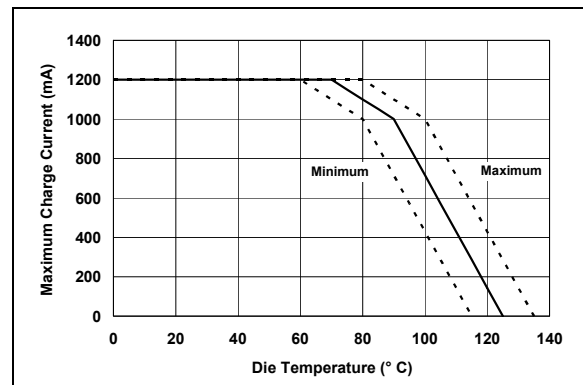

FIGURE 4-1: Typical Maximum Charge Current vs. Die Temperature.

4.6 Thermal Shutdown

The MCP7386X family suspends charge if the die temperature exceeds 155°C. Charging will resume when the die temperature has cooled by approximately 10°C. The thermal shutdown is a secondary safety feature in the event that there is a failure within the thermal regulation circuitry.

5.0 DETAILED DESCRIPTION

5.1 Analog Circuitry

5.1.1 BATTERY MANAGEMENT INPUT SUPPLY (V_{DD1} , V_{DD2})

The V_{DD} input is the input supply to the MCP7386X. The MCP7386X automatically enters a Power-down mode if the voltage on the V_{DD} input falls below the UVLO voltage (V_{STOP}). This feature prevents draining the battery pack when the V_{DD} supply is not present. The V_{DD} inputs should be tied to ground with a resistor $\leq 1.5\text{ k}\Omega$ to prevent V_{DD} from floating and staying at V_{BAT} level if the input supply is disconnected. The resistor will assure that $V_{DD} < V_{BAT}$ when the input supply is removed.

5.1.2 PROG INPUT

Fast charge current regulation can be scaled by placing a programming resistor (R_{PROG}) from the PROG input to V_{SS} . Connecting the PROG input to V_{SS} allows for a maximum fast charge current of 1.2A, typically. The minimum fast charge current is 100 mA, set by letting the PROG input float. The following formula calculates the value for R_{PROG} :

$$R_{PROG} = \frac{13.2 - 11 \times I_{REG}}{12 \times I_{REG} - 1.2}$$

Where:

I_{REG} = the desired fast charge current in amps.

R_{PROG} = measured in $\text{k}\Omega$.

The preconditioning trickle-charge current and the charge termination current are scaled to approximately 10% and 8% of I_{REG} respectively.

5.1.3 CELL TEMPERATURE SENSOR BIAS (THREF)

A 2.5V voltage reference is provided to bias an external thermistor for continuous cell temperature monitoring and prequalification. A ratio metric window comparison is performed at threshold levels of $V_{THREF}/2$ and $V_{THREF}/4$.

5.1.4 CELL TEMPERATURE SENSOR INPUT (THERM)

The MCP73861/2/3/4 continuously monitors temperature by comparing the voltage between the THERM input and V_{SS} with the upper and lower temperature thresholds. A negative or positive temperature coefficient, NTC or PTC thermistor and an external voltage-divider typically develop this voltage. The temperature sensing circuit has its own reference to which it performs a ratio metric comparison. Therefore, it is immune to fluctuations in the supply input (V_{DD}). The

temperature-sensing circuit is removed from the system when V_{DD} is not applied, eliminating additional discharge of the battery pack.

Figure 6-1 depicts a typical application circuit with connection of the THERM input. The resistor values of R_{T1} and R_{T2} are calculated with the following equations.

For NTC thermistors:

$$R_{T1} = \frac{2 \times R_{COLD} \times R_{HOT}}{R_{COLD} - R_{HOT}}$$

$$R_{T2} = \frac{2 \times R_{COLD} \times R_{HOT}}{R_{COLD} - 3 \times R_{HOT}}$$

For PTC thermistors:

$$R_{T1} = \frac{2 \times R_{COLD} \times R_{HOT}}{R_{HOT} - R_{COLD}}$$

$$R_{T2} = \frac{2 \times R_{COLD} \times R_{HOT}}{R_{HOT} - 3 \times R_{COLD}}$$

Where:

R_{COLD} and R_{HOT} are the thermistor resistance values at the temperature window of interest.

Applying a voltage equal to $V_{THREF}/3$ to the THERM input disables temperature monitoring.

5.1.5 TIMER SET INPUT (TIMER)

The TIMER input programs the period of the safety timers by placing a timing capacitor (C_{TIMER}) between the TIMER input pin and V_{SS} . Three safety timers are programmed via the timing capacitor.

The preconditioning safety timer period:

$$t_{PRECON} = \frac{C_{TIMER}}{0.1\mu F} \times 1.0\text{Hours}$$

The fast charge safety timer period:

$$t_{FAST} = \frac{C_{TIMER}}{0.1\mu F} \times 1.5\text{Hours}$$

The elapsed time termination period:

$$t_{TERM} = \frac{C_{TIMER}}{0.1\mu F} \times 3.0\text{Hours}$$

The preconditioning timer starts after qualification and resets when the charge cycle transitions to the fast charge, Constant-current mode. The fast charge timer and the elapsed timer start once the MCP7386X transitions from preconditioning. The fast charge timer resets when the charge cycle transitions to the Constant-voltage mode. The elapsed timer will expire and terminate the charge if the sensed current does not diminish below the termination threshold.

MCP73861/2/3/4

During thermal regulation, the timer is slowed down proportional to the charge current.

5.1.6 BATTERY VOLTAGE SENSE (V_{BAT3})

The MCP7386X monitors the battery voltage at the V_{BAT3} pin. This input is tied directly to the positive terminal of the battery pack.

5.1.7 BATTERY CHARGE CONTROL OUTPUT (V_{BAT1} , V_{BAT2})

The battery charge control output is the drain terminal of an internal P-channel MOSFET. The MCP7386X provides constant current and voltage regulation to the battery pack by controlling this MOSFET in the linear region. The battery charge control output should be connected to the positive terminal of the battery pack.

5.2 Digital Circuitry

5.2.1 CHARGE STATUS OUTPUTS (STAT1, STAT2)

Two status outputs provide information on the state of charge. The current-limited, open-drain outputs can be used to illuminate external LEDs. Optionally, a pull-up resistor can be used on the output for communication with a host microcontroller. [Table 5-1](#) summarizes the state of the status outputs during a charge cycle.

TABLE 5-1: STATUS OUTPUTS

CHARGE CYCLE STAT1	STAT1	STAT2
Qualification	Off	Off
Preconditioning	On	Off
Constant-Current Fast Charge	On	Off
Constant-Voltage	On	Off
Charge Complete	Flashing (1 Hz, 50% duty cycle) (MCP73861/2)	Off (All Devices)
	Off (MCP73863/4)	
Fault	Off	On
THERM Invalid	Off	Flashing (1 Hz 50% duty cycle)
Disabled – Sleep mode	Off	Off
Input Voltage Disconnected (1.5K Ω Pulldown)	Off	Off

Legend: Off state: Open-drain is high-impedance
 On state: Open-drain can sink current typically 7 mA
 Flashing: Toggles between off state and on state

The flashing rate (1 Hz) is based off a timer capacitor (C_{TIMER}) of 0.1 μ F. The rate will vary based on the value of the timer capacitor.

During a Fault condition, the STAT1 status output will be off and the STAT2 status output will be on. To recover from a Fault condition, the input voltage must be removed and then reapplied, or the enable input (EN) must be de-asserted to a logic-low, then asserted to a logic-high.

When the voltage on the THERM input is outside the preset window, the charge cycle will not start, or will be suspended. The charge cycle is not terminated and recovery is automatic. The charge cycle will resume (or start) once the THERM input is valid and all other qualification parameters are met. During an invalid THERM condition, the STAT1 status output will be off and the STAT2 status output will flash.

5.2.2 V_{SET} INPUT

The V_{SET} input selects the regulated output voltage of the MCP7386X. With V_{SET} tied to V_{SS} , the MCP73861/3 and MCP73862/4 regulate to 4.1V and 8.2V, respectively. With V_{SET} tied to V_{DD} , the MCP73861/3 and MCP73862/4 regulate to 4.2V and 8.4V, respectively.

5.2.3 LOGIC ENABLE (EN)

The logic enable input pin (EN) can be used to terminate a charge at any time during the charge cycle, as well as to initiate a charge cycle or initiate a recharge cycle.

Applying a logic-high input signal to the EN pin, or tying it to the input source, enables the device. Applying a logic-low input signal disables the device and terminates a charge cycle. When disabled, the device's supply current is reduced to 0.17 μ A, typically.

6.0 APPLICATIONS

The MCP7386X is designed to operate in conjunction with a host microcontroller or in stand-alone applications. The MCP7386X provides the preferred charge algorithm for Lithium-Ion and Lithium-Polymer cells Constant-current followed by Constant-voltage.

Figure 6-1 illustrates a typical stand-alone application circuit, while Figures 6-2 and 6-3 illustrate the accompanying charge profile

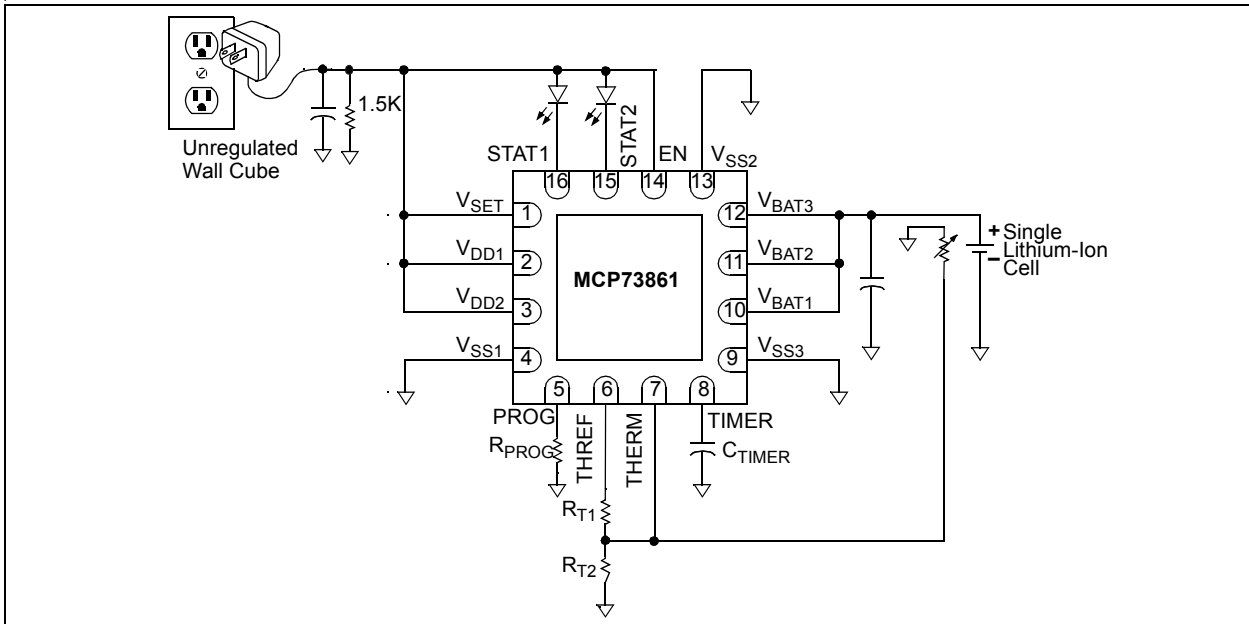

FIGURE 6-1: Typical Application Circuit.

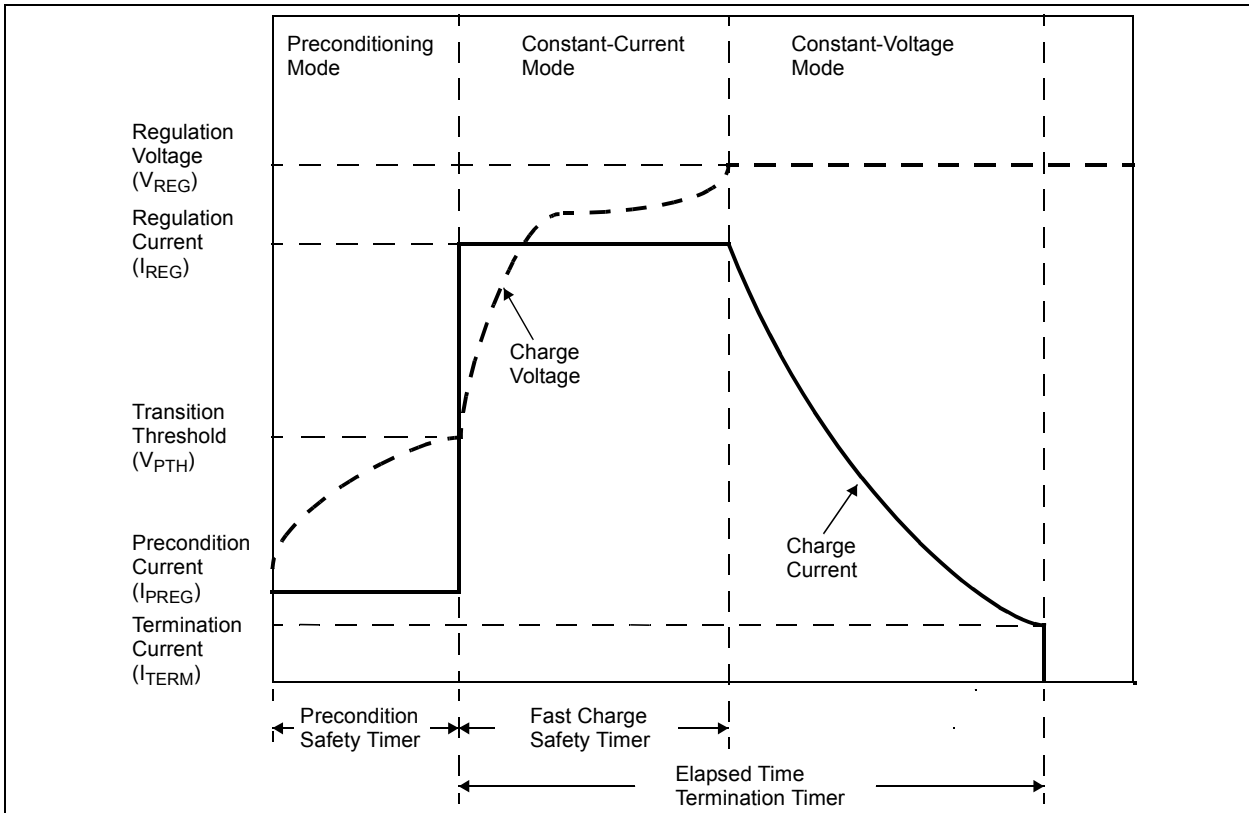

FIGURE 6-2: Typical Charge Profile.

MCP73861/2/3/4

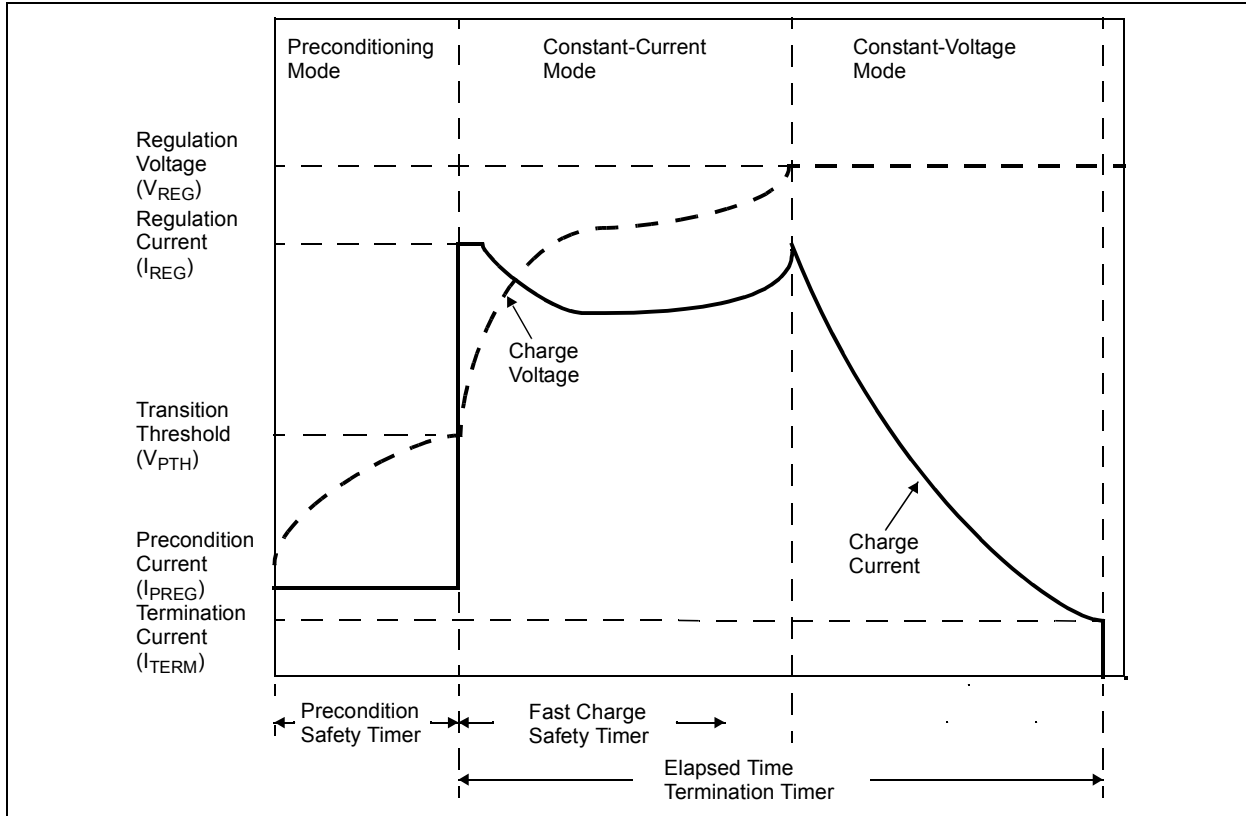

FIGURE 6-3: Typical Charge Profile in Thermal Regulation.

6.1 Application Circuit Design

Due to the low efficiency of linear charging, the most important factors are thermal design and cost, which are a direct function of the input voltage, output current and thermal impedance between the battery charger and the ambient cooling air. The worst-case situation is when the device has transitioned from the Preconditioning mode to the Constant-current mode. In this situation, the battery charger has to dissipate the maximum power. A trade-off must be made between the charge current, cost and thermal requirements of the charger.

6.1.1 COMPONENT SELECTION

Selection of the external components in [Figure 6-1](#) is crucial to the integrity and reliability of the charging system. The following discussion is intended as a guide for the component selection process.

6.1.1.1 Current Programming Resistor (R_{PROG})

The preferred fast charge current for Lithium-Ion cells is at the 1C rate, with an absolute maximum current at the 2C rate. For example, a 500 mAh battery pack has a preferred fast charge current of 500 mA. Charging at this rate provides the shortest charge cycle times without degradation to the battery pack performance or life.

1200 mA is the maximum charge current obtainable from the MCP7386X. For this situation, the PROG input should be connected directly to V_{SS}.

6.1.1.2 Thermal Considerations

The worst-case power dissipation in the battery charger occurs when the input voltage is at the maximum and the device has transitioned from the Preconditioning mode to the Constant-current mode. In this case, the power dissipation is:

$$PowerDissipation = (V_{DDMAX} - V_{PTHMIN}) \times I_{REGMAX}$$

Where:

- V_{DDMAX} = the maximum input voltage
- I_{REGMAX} = the maximum fast charge current
- V_{PTHMIN} = the minimum transition threshold voltage

Power dissipation with a 5V, ±10% input voltage source is:

$$PowerDissipation = (5.5V - 2.7V) \times 575mA = 1.61W$$

With the battery charger mounted on a 1 in² pad of 1 oz. copper, the junction temperature rise is 60°C, approximately. This would allow for a maximum operating ambient temperature of 50°C before thermal regulation is entered.

6.1.1.3 External Capacitors

The MCP7386X is stable with or without a battery load. In order to maintain good AC stability in the Constant-voltage mode, a minimum capacitance of 4.7 µF is recommended to bypass the V_{BAT} pin to V_{SS}. This capacitance provides compensation when there is no battery load. In addition, the battery and interconnections appear inductive at high frequencies. These elements are in the control feedback loop during Constant-voltage mode. Therefore, the bypass capacitance may be necessary to compensate for the inductive nature of the battery pack.

Virtually any good quality output filter capacitor can be used, independent of the capacitor's minimum Effective Series Resistance (ESR) value. The actual value of the capacitor (and its associated ESR) depends on the output load current. A 4.7 µF ceramic, tantalum or aluminum electrolytic capacitor at the output is usually sufficient to ensure stability for up to a 1A output current.

6.1.1.4 Reverse-Blocking Protection

The MCP7386X provides protection from a faulted or shorted input, or from a reversed-polarity input source. Without the protection, a faulted or shorted input would discharge the battery pack through the body diode of the internal pass transistor.

6.1.1.5 Enable Interface

In the stand-alone configuration, the enable pin is generally tied to the input voltage. The MCP7386X automatically enters a Low-power mode when voltage on the V_{DD} input falls below the UVLO voltage (V_{STOP}), reducing the battery drain current to 0.23 µA, typically.

6.1.1.6 Charge Status Interface

Two status outputs provide information on the state of charge. The current-limited, open-drain outputs can be used to illuminate external LEDs. Refer to [Table 5-1](#) for a summary of the state of the status outputs during a charge cycle.

6.2 PCB Layout Issues

For optimum voltage regulation, place the battery pack as close as possible to the device's V_{BAT} and V_{SS} pins, recommended to minimize voltage drops along the high current-carrying PCB traces.

If the PCB layout is used as a heatsink, adding many vias in the heatsink pad can help conduct more heat to the backplane of the PCB, thus reducing the maximum junction temperature.

MCP73861/2/3/4

NOTES:

7.0 PACKAGING INFORMATION

7.1 Package Marking Information

16-Lead QFN

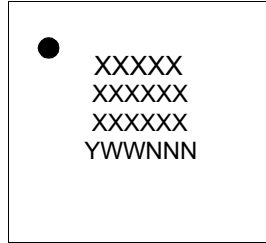

Example:

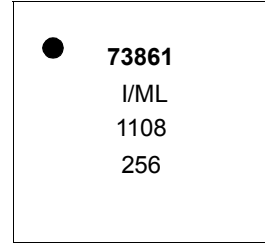

16-Lead SOIC (150 mil)

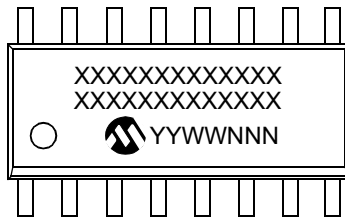

Example:

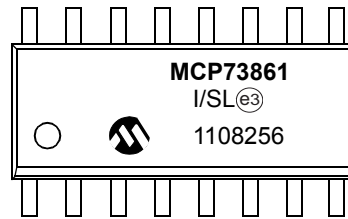

Legend:	XX...X	Customer-specific information
	Y	Year code (last digit of calendar year)
	YY	Year code (last 2 digits of calendar year)
	WW	Week code (week of January 1 is week '01')
	NNN	Alphanumeric traceability code
	(e3)	Pb-free JEDEC designator for Matte Tin (Sn)
	*	This package is Pb-free. The Pb-free JEDEC designator (e3) can be found on the outer packaging for this package.

Note: In the event the full Microchip part number cannot be marked on one line, it will be carried over to the next line, thus limiting the number of available characters for customer-specific information.

MCP73861/2/3/4

16-Lead Plastic Quad Flat, No Lead Package (ML) – 4x4x0.9 mm Body [QFN]

Note: For the most current package drawings, please see the Microchip Packaging Specification located at <http://www.microchip.com/packaging>

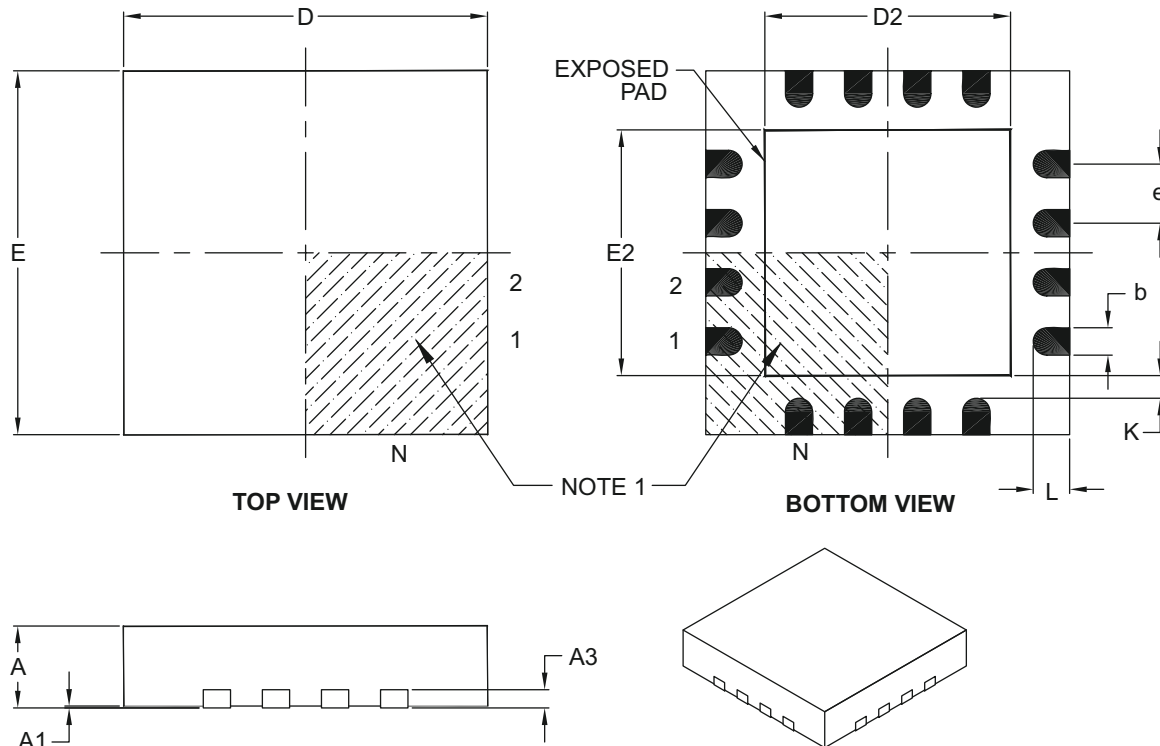

Dimension Limits	Units	MILLIMETERS		
		MIN	NOM	MAX
Number of Pins	N	16		
Pitch	e	0.65 BSC		
Overall Height	A	0.80	0.90	1.00
Standoff	A1	0.00	0.02	0.05
Contact Thickness	A3	0.20 REF		
Overall Width	E	4.00 BSC		
Exposed Pad Width	E2	2.50	2.65	2.80
Overall Length	D	4.00 BSC		
Exposed Pad Length	D2	2.50	2.65	2.80
Contact Width	b	0.25	0.30	0.35
Contact Length	L	0.30	0.40	0.50
Contact-to-Exposed Pad	K	0.20	–	–

Notes:

- Pin 1 visual index feature may vary, but must be located within the hatched area.
- Package is saw singulated.
- Dimensioning and tolerancing per ASME Y14.5M.

BSC: Basic Dimension. Theoretically exact value shown without tolerances.

REF: Reference Dimension, usually without tolerance, for information purposes only.

Microchip Technology Drawing C04-127B

16-Lead Plastic Quad Flat, No Lead Package (ML) - 4x4x0.9mm Body [QFN]

Note: For the most current package drawings, please see the Microchip Packaging Specification located at <http://www.microchip.com/packaging>

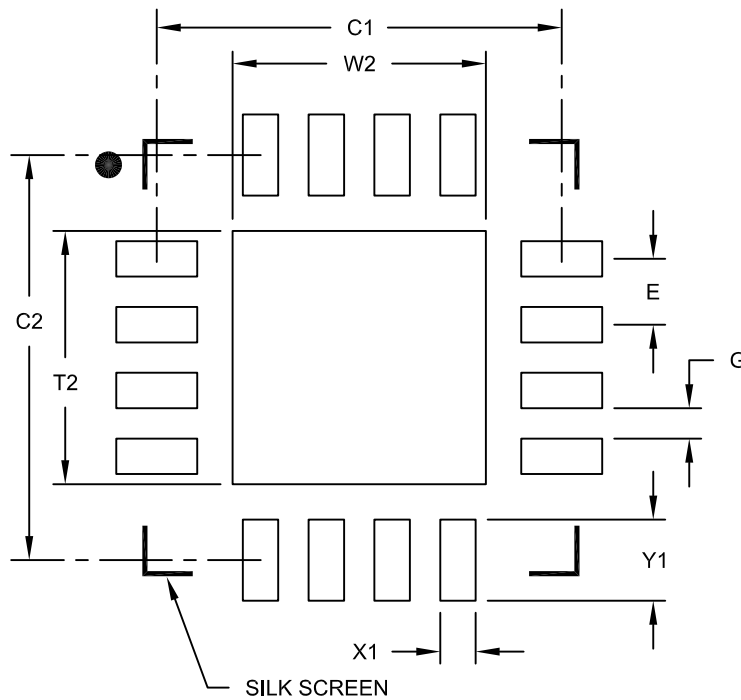

RECOMMENDED LAND PATTERN

Dimension Limits	Units	MILLIMETERS		
		MIN	NOM	MAX
Contact Pitch	E	0.65 BSC		
Optional Center Pad Width	W2			2.50
Optional Center Pad Length	T2			2.50
Contact Pad Spacing	C1		4.00	
Contact Pad Spacing	C2		4.00	
Contact Pad Width (X16)	X1			0.35
Contact Pad Length (X16)	Y1			0.80
Distance Between Pads	G	0.30		

Notes:

1. Dimensioning and tolerancing per ASME Y14.5M

BSC: Basic Dimension. Theoretically exact value shown without tolerances.

Microchip Technology Drawing No. C04-2127A

MCP73861/2/3/4

16-Lead Plastic Small Outline (SL) - Narrow, 3.90 mm Body [SOIC]

Note: For the most current package drawings, please see the Microchip Packaging Specification located at <http://www.microchip.com/packaging>

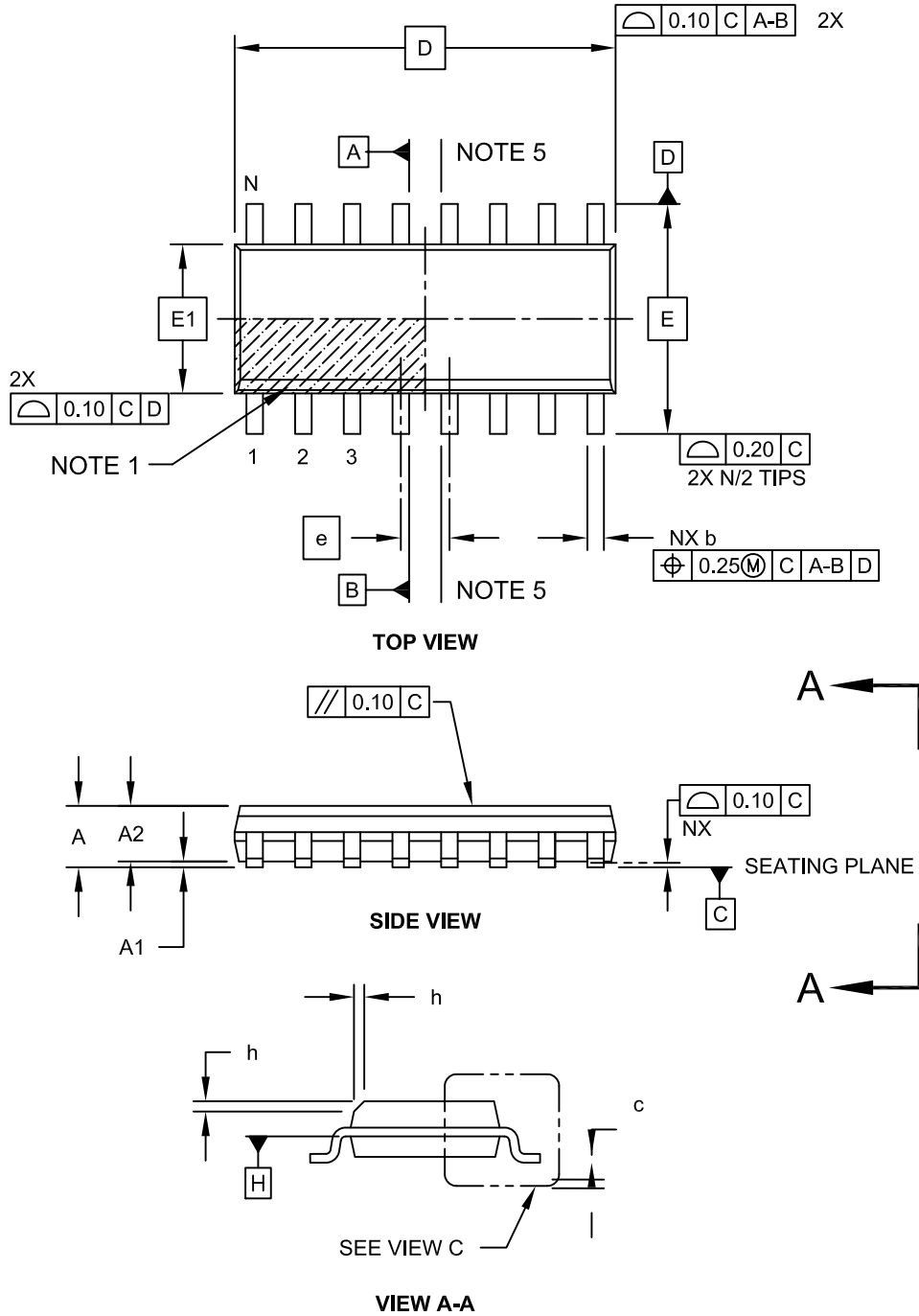

Microchip Technology Drawing No. C04-108C Sheet 1 of 2

16-Lead Plastic Small Outline (SL) - Narrow, 3.90 mm Body [SOIC]

Note: For the most current package drawings, please see the Microchip Packaging Specification located at <http://www.microchip.com/packaging>

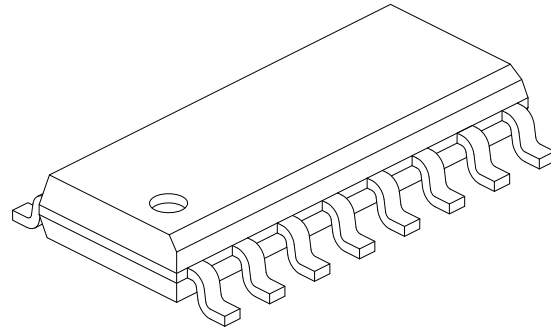
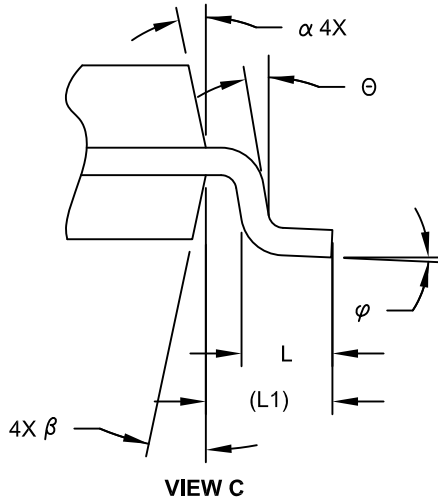

Dimension Limits	Units	MILLIMETERS		
		MIN	NOM	MAX
Number of Pins	N	16		
Pitch	e	1.27 BSC		
Overall Height	A	-	-	1.75
Molded Package Thickness	A2	1.25	-	-
Standoff §	A1	0.10	-	0.25
Overall Width	E	6.00 BSC		
Molded Package Width	E1	3.90 BSC		
Overall Length	D	9.90 BSC		
Chamfer (Optional)	h	0.25	-	0.50
Foot Length	L	0.40	-	1.27
Footprint	L1	1.04 REF		
Lead Angle	Θ	0°	-	-
Foot Angle	φ	0°	-	8°
Lead Thickness	c	0.10	-	0.25
Lead Width	b	0.31	-	0.51
Mold Draft Angle Top	α	5°	-	15°
Mold Draft Angle Bottom	β	5°	-	15°

Notes:

- Pin 1 visual index feature may vary, but must be located within the hatched area.
- § Significant Characteristic
- Dimension D does not include mold flash, protrusions or gate burrs, which shall not exceed 0.15 mm per end. Dimension E1 does not include interlead flash or protrusion, which shall not exceed 0.25 mm per side.
- Dimensioning and tolerancing per ASME Y14.5M
 BSC: Basic Dimension. Theoretically exact value shown without tolerances.
 REF: Reference Dimension, usually without tolerance, for information purposes only.
- Datums A & B to be determined at Datum H.

Microchip Technology Drawing No. C04-108C Sheet 2 of 2

MCP73861/2/3/4

16-Lead Plastic Small Outline (SL) - Narrow, 3.90 mm Body [SOIC]

Note: For the most current package drawings, please see the Microchip Packaging Specification located at <http://www.microchip.com/packaging>

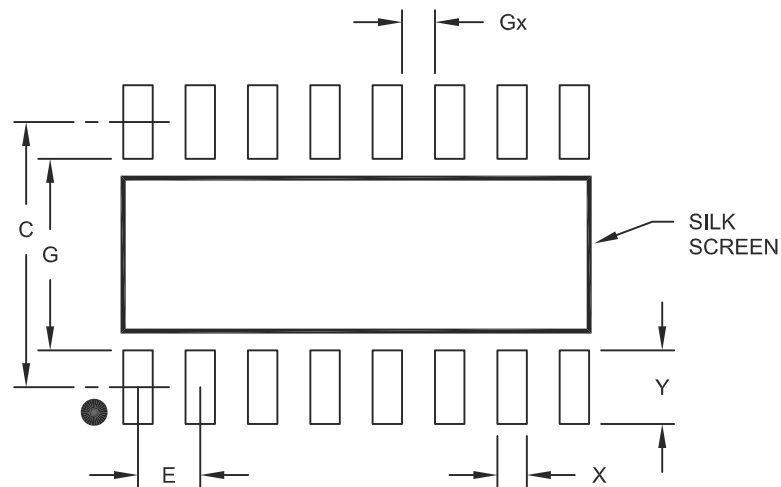

RECOMMENDED LAND PATTERN

Dimension Limits	Units	MILLIMETERS		
		MIN	NOM	MAX
Contact Pitch	E	1.27 BSC		
Contact Pad Spacing	C		5.40	
Contact Pad Width	X			0.60
Contact Pad Length	Y			1.50
Distance Between Pads	Gx	0.67		
Distance Between Pads	G	3.90		

Notes:

1. Dimensioning and tolerancing per ASME Y14.5M

BSC: Basic Dimension. Theoretically exact value shown without tolerances.

Microchip Technology Drawing No. C04-2108A

APPENDIX A: REVISION HISTORY

Revision F (March 2013)

The following is the list of modifications:

1. Added the Output Reverse Leakage Switchover Time parameter to the DC Characteristics table.
2. Updated Section 3.2.
3. Updated Section 5.1.1.
4. Updated [Figure 6-1](#).

Revision E (April 2011)

The following is the list of modifications:

1. Updated [Figure 2-4](#).

Revision D (December 2008)

The following is the list of modifications:

1. Updated package outline diagrams.

Revision C (August 2005)

The following is the list of modifications:

1. Added MCP73863 and MCP73864 devices throughout data sheet.
2. Added Appendix A: Revision History.
3. Updated QFN and SOIC package diagrams.

Revision B (December 2004)

The following is the list of modifications:

Added SOIC package throughout data sheet.

Revision A (June 2004)

Original Release of this Document.

MCP73861/2/3/4

NOTES:

PRODUCT IDENTIFICATION SYSTEM

To order or obtain information, e.g., on pricing or delivery, contact the Microchip sales office.

<u>PART NO.</u>		<u>X</u>	<u>/XX</u>	Examples:
Device	Temperature Range		Package	
Device:	MCP73861:	Single-Cell Charge Controller with Temperature Monitor		a) MCP73861-I/ML: Single-Cell Controller 16LD-QFN package.
	MCP73861T:	Single-Cell Charge Controller with Temperature Monitor, Tape and Reel		b) MCP73861T-I/ML: Tape and Reel, Single-Cell Controller 16LD-QFN package.
	MCP73862:	Dual Series Cells Charge Controller with Temperature Monitor		c) MCP73861-I/SL: Single-Cell Controller 16LD-SOIC package.
	MCP73862T:	Dual Series Cells Charge Controller with Temperature Monitor, Tape and Reel		d) MCP73861T-I/SL: Tape and Reel, Single-Cell Controller 16LD-SOIC package.
	MCP73863:	Single-cell Charge Controller with Temperature Monitor		a) MCP73862-I/ML: Dual-Cell Controller 16LD-QFN package.
	MCP73863T:	Single-Cell Charge Controller with Temperature Monitor, Tape and Reel		b) MCP73862T-I/ML: Tape and Reel, Dual-Cell Controller 16LD-QFN package.
	MCP73864:	Dual Series Cells Charge Controller with Temperature Monitor		c) MCP73862-I/SL: Dual-Cell Controller 16LD-SOIC package.
	MCP73864T:	Dual Series Cells Charge Controller with Temperature Monitor, Tape and Reel		d) MCP73862T-I/SL: Tape and Reel, Dual-Cell Controller 16LD-SOIC package.
Temperature Range:	I	= -40°C to +85°C (Industrial)		a) MCP73863-I/ML: Single-Cell Controller 16LD-QFN package.
Package:	ML	= Plastic Quad Flat No Lead, 4x4 mm Body (QFN), 16-lead		b) MCP73863T-I/ML: Tape and Reel, Single-Cell Controller 16LD-QFN package.
	SL	= Plastic Small Outline, 150 mm Body (SOIC), 16-lead		c) MCP73863-I/SL: Single-Cell Controller 16LD-SOIC package.
				d) MCP73863T-I/SL: Tape and Reel, Single-Cell Controller 16LD-SOIC package.
				a) MCP73864-I/ML: Dual-Cell Controller 16LD-QFN package.
				b) MCP73864T-I/ML: Tape and Reel, Dual-Cell Controller 16LD-QFN package.
				c) MCP73864-I/SL: Dual-Cell Controller 16LD-SOIC package.
				d) MCP73864T-I/SL: Tape and Reel, Dual-Cell Controller 16LD-SOIC package.

MCP73861/2/3/4

NOTES:

Note the following details of the code protection feature on Microchip devices:

- Microchip products meet the specification contained in their particular Microchip Data Sheet.
- Microchip believes that its family of products is one of the most secure families of its kind on the market today, when used in the intended manner and under normal conditions.
- There are dishonest and possibly illegal methods used to breach the code protection feature. All of these methods, to our knowledge, require using the Microchip products in a manner outside the operating specifications contained in Microchip's Data Sheets. Most likely, the person doing so is engaged in theft of intellectual property.
- Microchip is willing to work with the customer who is concerned about the integrity of their code.
- Neither Microchip nor any other semiconductor manufacturer can guarantee the security of their code. Code protection does not mean that we are guaranteeing the product as “unbreakable.”

Code protection is constantly evolving. We at Microchip are committed to continuously improving the code protection features of our products. Attempts to break Microchip's code protection feature may be a violation of the Digital Millennium Copyright Act. If such acts allow unauthorized access to your software or other copyrighted work, you may have a right to sue for relief under that Act.

Information contained in this publication regarding device applications and the like is provided only for your convenience and may be superseded by updates. It is your responsibility to ensure that your application meets with your specifications. MICROCHIP MAKES NO REPRESENTATIONS OR WARRANTIES OF ANY KIND WHETHER EXPRESS OR IMPLIED, WRITTEN OR ORAL, STATUTORY OR OTHERWISE, RELATED TO THE INFORMATION, INCLUDING BUT NOT LIMITED TO ITS CONDITION, QUALITY, PERFORMANCE, MERCHANTABILITY OR FITNESS FOR PURPOSE. Microchip disclaims all liability arising from this information and its use. Use of Microchip devices in life support and/or safety applications is entirely at the buyer's risk, and the buyer agrees to defend, indemnify and hold harmless Microchip from any and all damages, claims, suits, or expenses resulting from such use. No licenses are conveyed, implicitly or otherwise, under any Microchip intellectual property rights.

Trademarks

The Microchip name and logo, the Microchip logo, dsPIC, FlashFlex, KEELOQ, KEELOQ logo, MPLAB, PIC, PICmicro, PICSTART, PIC³² logo, rPIC, SST, SST Logo, SuperFlash and UNI/O are registered trademarks of Microchip Technology Incorporated in the U.S.A. and other countries.

FilterLab, Hampshire, HI-TECH C, Linear Active Thermistor, MTP, SEEVAL and The Embedded Control Solutions Company are registered trademarks of Microchip Technology Incorporated in the U.S.A.

Silicon Storage Technology is a registered trademark of Microchip Technology Inc. in other countries.

Analog-for-the-Digital Age, Application Maestro, BodyCom, chipKIT, chipKIT logo, CodeGuard, dsPICDEM, dsPICDEM.net, dsPICworks, dsSPEAK, ECAN, ECONOMONITOR, FanSense, HI-TIDE, In-Circuit Serial Programming, ICSP, Mindi, MiWi, MPASM, MPF, MPLAB Certified logo, MPLIB, MPLINK, mTouch, Omniclient Code Generation, PICC, PICC-18, PICDEM, PICDEM.net, PICkit, PICtail, REAL ICE, rFLAB, Select Mode, SQI, Serial Quad I/O, Total Endurance, TSHARC, UniWinDriver, WiperLock, ZENA and Z-Scale are trademarks of Microchip Technology Incorporated in the U.S.A. and other countries.

SQTP is a service mark of Microchip Technology Incorporated in the U.S.A.

GestIC and ULPP are registered trademarks of Microchip Technology Germany II GmbH & Co. KG, a subsidiary of Microchip Technology Inc., in other countries.

All other trademarks mentioned herein are property of their respective companies.

© 2004-2013, Microchip Technology Incorporated, Printed in the U.S.A., All Rights Reserved.

 Printed on recycled paper.

ISBN: 9781620770405

QUALITY MANAGEMENT SYSTEM
CERTIFIED BY DNV
== ISO/TS 16949 ==

Microchip received ISO/TS-16949:2009 certification for its worldwide headquarters, design and wafer fabrication facilities in Chandler and Tempe, Arizona; Gresham, Oregon and design centers in California and India. The Company's quality system processes and procedures are for its PIC[®] MCUs and dsPIC[®] DSCs, KEELOQ[®] code hopping devices, Serial EEPROMs, microperipherals, nonvolatile memory and analog products. In addition, Microchip's quality system for the design and manufacture of development systems is ISO 9001:2000 certified.



MICROCHIP

Worldwide Sales and Service

AMERICAS

Corporate Office
2355 West Chandler Blvd.
Chandler, AZ 85224-6199
Tel: 480-792-7200
Fax: 480-792-7277
Technical Support:
<http://www.microchip.com/support>
Web Address:
www.microchip.com

Atlanta
Duluth, GA
Tel: 678-957-9614
Fax: 678-957-1455

Boston
Westborough, MA
Tel: 774-760-0087
Fax: 774-760-0088

Chicago
Itasca, IL
Tel: 630-285-0071
Fax: 630-285-0075

Cleveland
Independence, OH
Tel: 216-447-0464
Fax: 216-447-0643

Dallas
Addison, TX
Tel: 972-818-7423
Fax: 972-818-2924

Detroit
Farmington Hills, MI
Tel: 248-538-2250
Fax: 248-538-2260

Indianapolis
Noblesville, IN
Tel: 317-773-8323
Fax: 317-773-5453

Los Angeles
Mission Viejo, CA
Tel: 949-462-9523
Fax: 949-462-9608

Santa Clara
Santa Clara, CA
Tel: 408-961-6444
Fax: 408-961-6445

Toronto
Mississauga, Ontario,
Canada
Tel: 905-673-0699
Fax: 905-673-6509

ASIA/PACIFIC

Asia Pacific Office
Suites 3707-14, 37th Floor
Tower 6, The Gateway
Harbour City, Kowloon
Hong Kong
Tel: 852-2401-1200
Fax: 852-2401-3431

Australia - Sydney
Tel: 61-2-9868-6733
Fax: 61-2-9868-6755

China - Beijing
Tel: 86-10-8569-7000
Fax: 86-10-8528-2104

China - Chengdu
Tel: 86-28-8665-5511
Fax: 86-28-8665-7889

China - Chongqing
Tel: 86-23-8980-9588
Fax: 86-23-8980-9500

China - Hangzhou
Tel: 86-571-2819-3187
Fax: 86-571-2819-3189

China - Hong Kong SAR
Tel: 852-2943-5100
Fax: 852-2401-3431

China - Nanjing
Tel: 86-25-8473-2460
Fax: 86-25-8473-2470

China - Qingdao
Tel: 86-532-8502-7355
Fax: 86-532-8502-7205

China - Shanghai
Tel: 86-21-5407-5533
Fax: 86-21-5407-5066

China - Shenyang
Tel: 86-24-2334-2829
Fax: 86-24-2334-2393

China - Shenzhen
Tel: 86-755-8864-2200
Fax: 86-755-8203-1760

China - Wuhan
Tel: 86-27-5980-5300
Fax: 86-27-5980-5118

China - Xian
Tel: 86-29-8833-7252
Fax: 86-29-8833-7256

China - Xiamen
Tel: 86-592-2388138
Fax: 86-592-2388130

China - Zhuhai
Tel: 86-756-3210040
Fax: 86-756-3210049

ASIA/PACIFIC

India - Bangalore
Tel: 91-80-3090-4444
Fax: 91-80-3090-4123

India - New Delhi
Tel: 91-11-4160-8631
Fax: 91-11-4160-8632

India - Pune
Tel: 91-20-2566-1512
Fax: 91-20-2566-1513

Japan - Osaka
Tel: 81-6-6152-7160
Fax: 81-6-6152-9310

Japan - Tokyo
Tel: 81-3-6880-3770
Fax: 81-3-6880-3771

Korea - Daegu
Tel: 82-53-744-4301
Fax: 82-53-744-4302

Korea - Seoul
Tel: 82-2-554-7200
Fax: 82-2-558-5932 or
82-2-558-5934

Malaysia - Kuala Lumpur
Tel: 60-3-6201-9857
Fax: 60-3-6201-9859

Malaysia - Penang
Tel: 60-4-227-8870
Fax: 60-4-227-4068

Philippines - Manila
Tel: 63-2-634-9065
Fax: 63-2-634-9069

Singapore
Tel: 65-6334-8870
Fax: 65-6334-8850

Taiwan - Hsin Chu
Tel: 886-3-5778-366
Fax: 886-3-5770-955

Taiwan - Kaohsiung
Tel: 886-7-213-7828
Fax: 886-7-330-9305

Taiwan - Taipei
Tel: 886-2-2508-8600
Fax: 886-2-2508-0102

Thailand - Bangkok
Tel: 66-2-694-1351
Fax: 66-2-694-1350

EUROPE

Austria - Wels
Tel: 43-7242-2244-39
Fax: 43-7242-2244-393

Denmark - Copenhagen
Tel: 45-4450-2828
Fax: 45-4485-2829

France - Paris
Tel: 33-1-69-53-63-20
Fax: 33-1-69-30-90-79

Germany - Munich
Tel: 49-89-627-144-0
Fax: 49-89-627-144-44

Italy - Milan
Tel: 39-0331-742611
Fax: 39-0331-466781

Netherlands - Drunen
Tel: 31-416-690399
Fax: 31-416-690340

Spain - Madrid
Tel: 34-91-708-08-90
Fax: 34-91-708-08-91

UK - Wokingham
Tel: 44-118-921-5869
Fax: 44-118-921-5820

11/29/12