

SODDERLUG DETAIL  
SCALE 2X

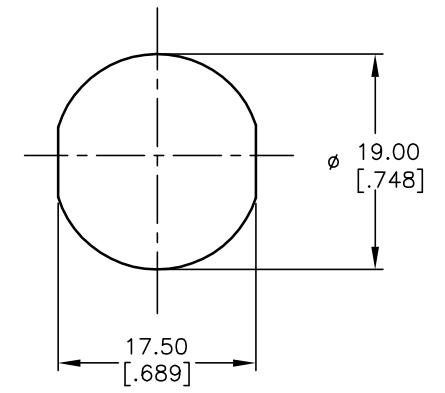

RECOMMENDED PANEL CUTOUT

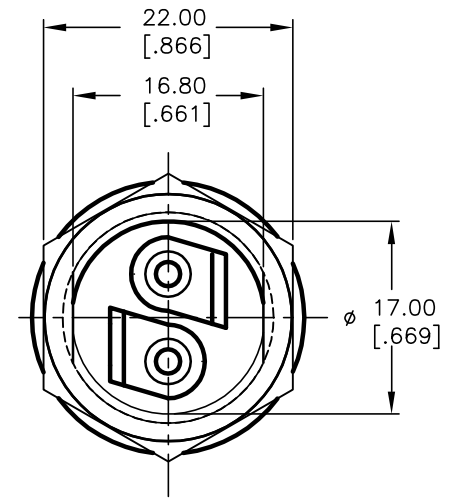
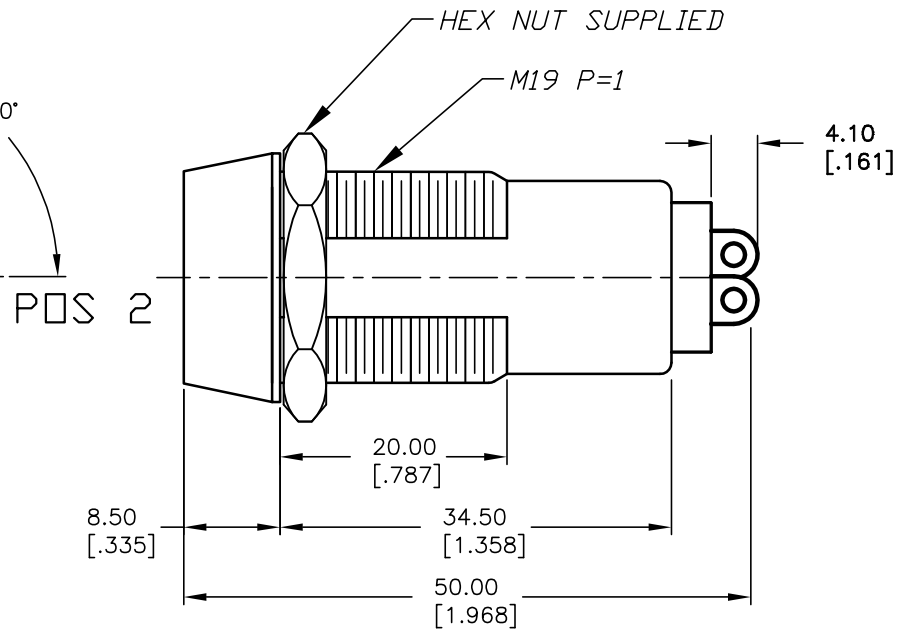
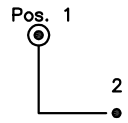

CIRCUIT: SPST  
CONTACT CONFIGURATION

SWITCH FUNCTION	
POS 1	POS 2
↑	→
OFF	ON

LEGEND

- = INDICATE NO KEY PULL
- ⊙ = INDICATES KEY PULL POSSIBLE

NOTES:

1. ALL DIMENSIONS IN MM [INCH]
2. GENERAL TOLERANCE: X.X=±0.4  
X.XX=±0.25
3. TERM. NOS. FOR REFERENCE ONLY.
4. RATING: 4A @125VAC, 2A @250VAC
5. CONTACT RESISTANCE: 10mILLI-OHMS
6. DIELECTRIC STRENGTH: 1500 VAC-1Minute
7. INSULATION RESISTANCE: 500 Mega-OHMS
8. MATERIALS:

HOUSING: ZINC ALLOY DIE CAST  
CYLINDER: ZINC ALLOY W/CHROME PLATING  
TERMINAL AND CONTACTS: SILVER PLATED  
TUMBLER: 5 DISC MECHANISM W/DUST SHUTTER  
KEYS 7312 (2): BRASS W/NICKEL PLATING  
DOUBLE CUT REVERSIBLE

**E-SWITCH®**

A	14089	RELEASED FOR PRODUCTION	6/10/04	AR
REV.	ECN No.	DESCRIPTION	DATE	CHKD

TITLE				
K0119A-7312				
SCALE	DATE	DR	DWG	REV
1.5:1	6/10/04	AR	K200142	A

THE INFORMATION CONTAINED IN THIS DOCUMENT  
IS PROPRIETARY TO E-SWITCH AND IS  
NOT TO BE COPIED OR TRANSFERRED