

## GaAs pHEMT MMIC 2 WATT POWER AMPLIFIER WITH POWER DETECTOR, 9 - 14 GHz



### Typical Applications

The HMC952 is ideal for:

- Point-to-Point Radios
- Point-to-Multi-Point Radios
- SATCOM

### Features

- +35 dBm Pout @ 28% PAE
- High Output IP3: +42 dBm
- High Gain: 36 dB
- DC Supply: +6V @ 1400 mA
- No External Matching Required
- Die Size: 3.46 x 1.73 x 0.1 mm

### Functional Diagram

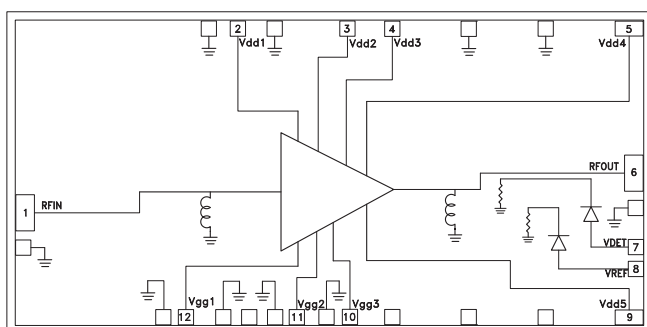

### General Description

The HMC952 is a four-stage GaAs pHEMT MMIC 2 Watt Power Amplifier with an integrated temperature compensated on-chip Power Detector which operates between 9 and 14 GHz. The HMC952 provides 36 dB of gain and +35 dBm of saturated output power at 28% PAE from a +6V power supply. The HMC952 exhibits excellent linearity and is optimized for high capacity Point-to-Point and Point-to-Multi-Point Radio systems. The amplifier configuration and high gain make it an excellent candidate for last stage signal amplification preceding the antenna. All data is taken with the chip in a 50 Ohm test fixture connected via (2) 0.025 mm (1 mil) diameter wire bonds of 0.31mm (12 mil) length.

### Electrical Specifications, $T_A = +25^\circ C$ , Vdd1, Vdd2, Vdd3, Vdd4, Vdd5 = +6V, Idd = 1400 mA [1]

Parameter	Min.	Typ.	Max.	Min.	Typ.	Max.	Units	
Frequency Range	9 - 10		10 - 14					GHz
Gain	34	37		33	36		dB	
Gain Variation Over Temperature		0.04			0.04		dB/ °C	
Input Return Loss		12			16		dB	
Output Return Loss		8			12		dB	
Output Power for 1 dB Compression (P1dB)	31	34		31.5	34.5		dBm	
Saturated Output Power (Psat)		35			35		dBm	
Output Third Order Intercept (IP3)[2]		41			42.5		dBm	
Total Supply Current (Idd)		1400			1400		mA	

[1] Adjust Vgg between -2 to 0V to achieve Idd = 1400 mA typical.

[2] Measurement taken at Pout / Tone = +20 dBm

**GaAs pHEMT MMIC 2 WATT POWER AMPLIFIER  
WITH POWER DETECTOR, 9 - 14 GHz**



**Broadband Gain &  
Return Loss vs. Frequency**

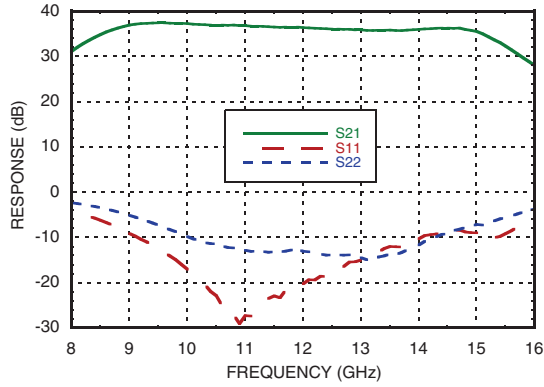

**Gain vs. Temperature**

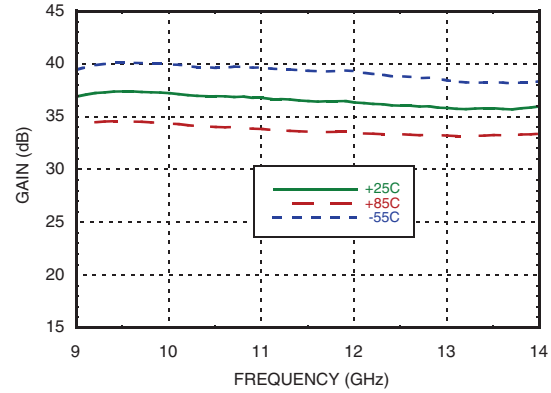

**Input Return Loss vs. Temperature**

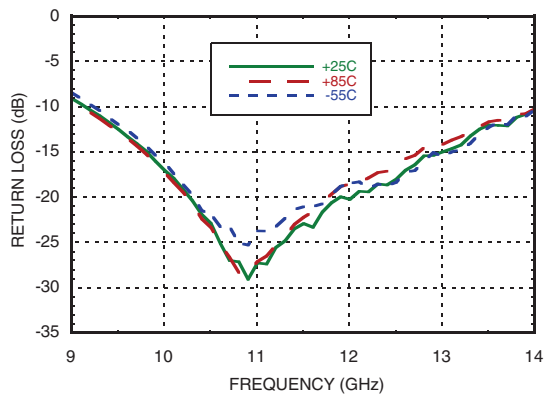

**Output Return Loss vs. Temperature**

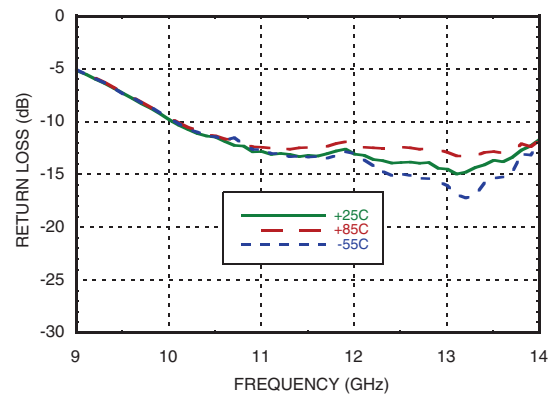

**P1dB vs. Temperature**

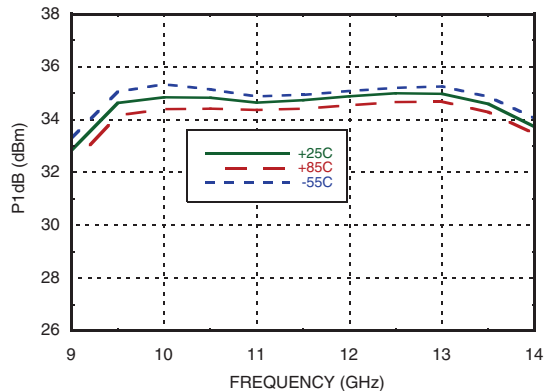

**P1dB vs. Supply Voltage [1]**

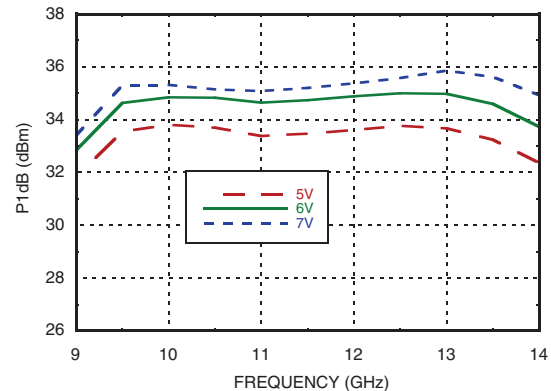

[1] 7V plot taken at I<sub>dd</sub>= 1200 mA, 5V and 6V plots taken I<sub>dd</sub>= 1400mA.

v02.0813

**GaAs pHEMT MMIC 2 WATT POWER AMPLIFIER  
WITH POWER DETECTOR, 9 - 14 GHz**



**Psat vs. Temperature**

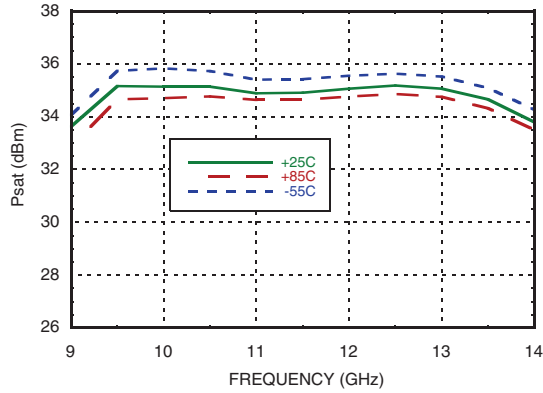

**Psat vs. Supply Voltage [1]**

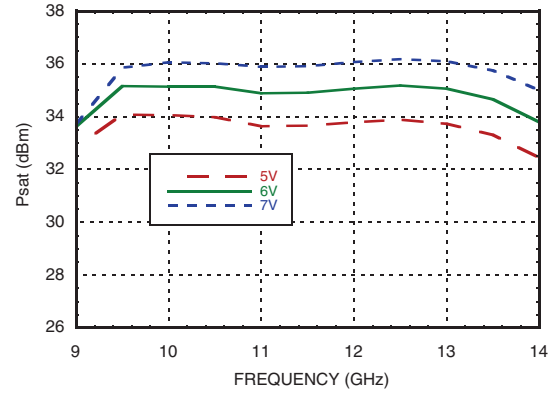

**P1dB vs. Supply Current (Idd)**

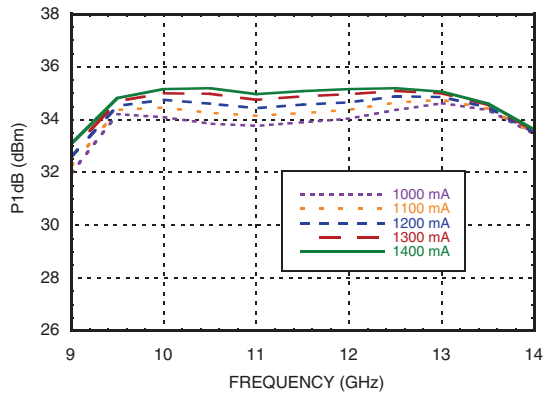

**Psat vs. Supply Current (Idd)**

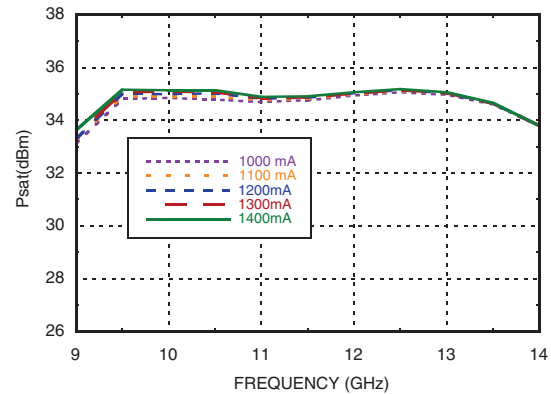

**Output IP3 vs. Temperature, Pout/Tone = +20 dBm**

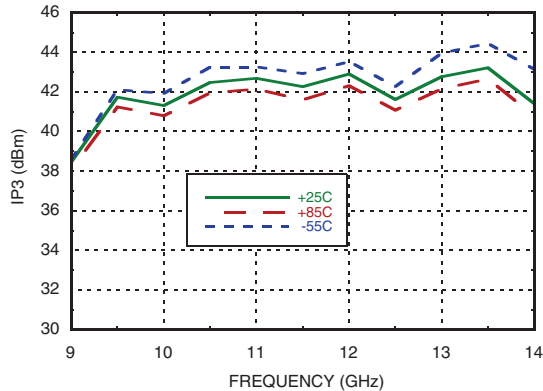

**Output IP3 vs. Supply Current, Pout/Tone = +20 dBm**

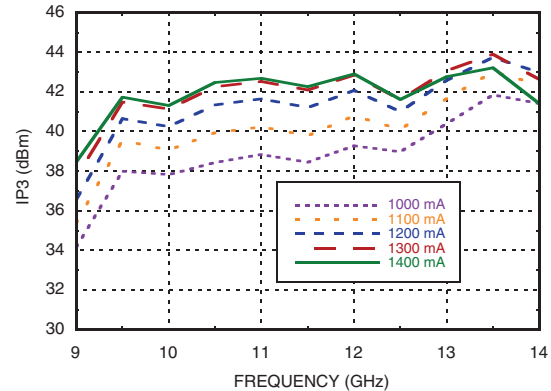

[1] 7V plot taken at Idd= 1200 mA, 5V and 6V plots taken Idd= 1400mA.

v02.0813

**GaAs pHEMT MMIC 2 WATT POWER AMPLIFIER WITH POWER DETECTOR, 9 - 14 GHz**



**Output IP3 vs. Supply Voltage, Pout/Tone = +20 dBm [1]**

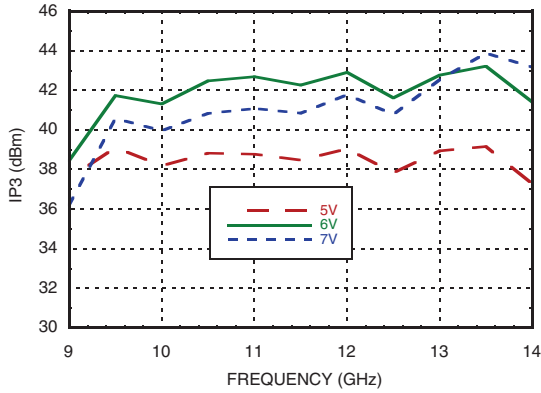

**Output IM3 @ Vdd = +5V**

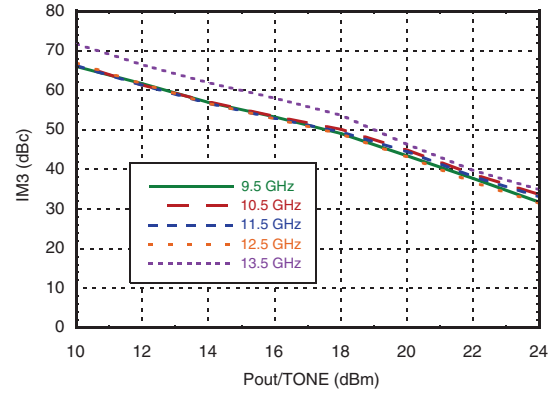

**Output IM3 @ Vdd = +6V**

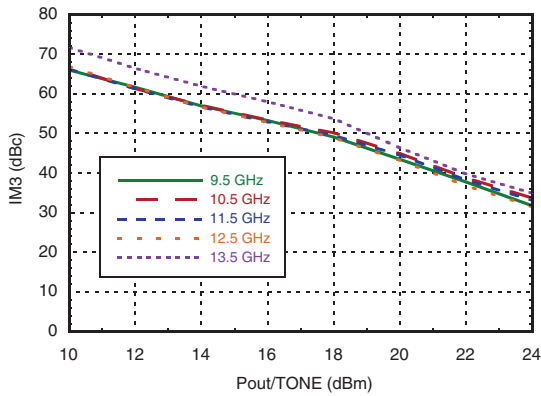

**Output IM3 @ Vdd = +7V [2]**

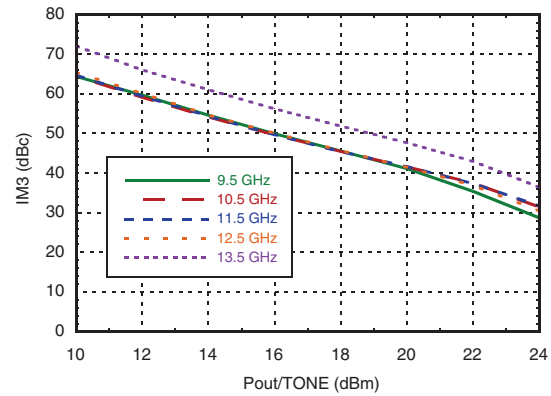

**Noise Figure vs Temperature**

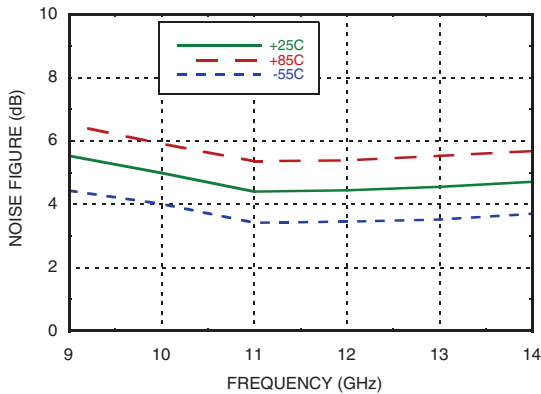

**Power Compression @ 9.5 GHz**

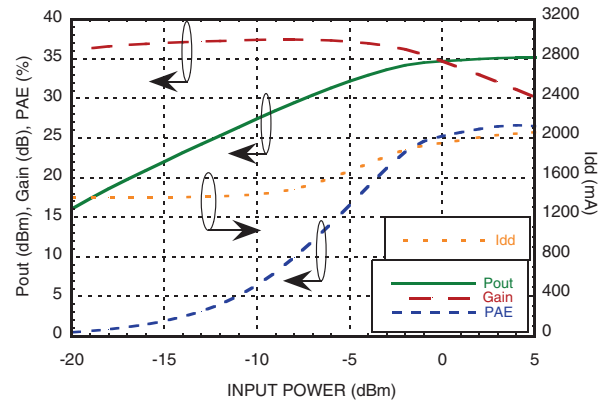

[1] 7V plot taken at Idd= 1200 mA, 5V and 6V plots taken Idd= 1400mA.

[2] 7V plot taken at Idd= 1200 mA.

Information furnished by Analog Devices is believed to be accurate and reliable. However, no responsibility is assumed by Analog Devices for its use, nor for any infringements of patents or other rights of third parties that may result from its use. Specifications subject to change without notice. No license is granted by implication or otherwise under any patent or patent rights of Analog Devices. Trademarks and registered trademarks are the property of their respective owners.

For price, delivery, and to place orders: Analog Devices, Inc., One Technology Way, P.O. Box 9106, Norwood, MA 02062-9106 Phone: 781-329-4700 • Order online at [www.analog.com](http://www.analog.com) Application Support: Phone: 1-800-ANALOG-D

**GaAs pHEMT MMIC 2 WATT POWER AMPLIFIER WITH POWER DETECTOR, 9 - 14 GHz**



AMPLIFIERS - LINEAR & POWER - CHIP

**Power Compression @ 11.5 GHz**

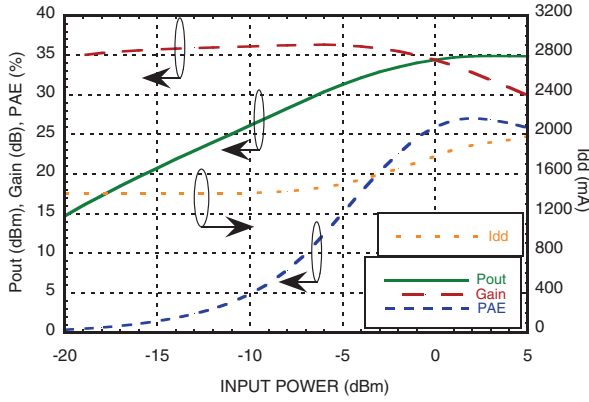

**Power Compression @ 13.5 GHz**

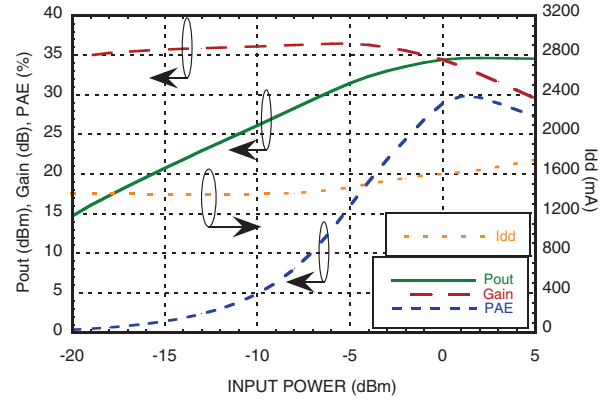

**Detector Voltage vs. Frequency & Temperature**

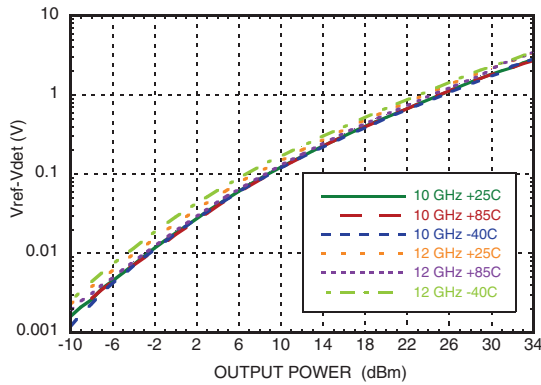

**Reverse Isolation vs. Temperature**

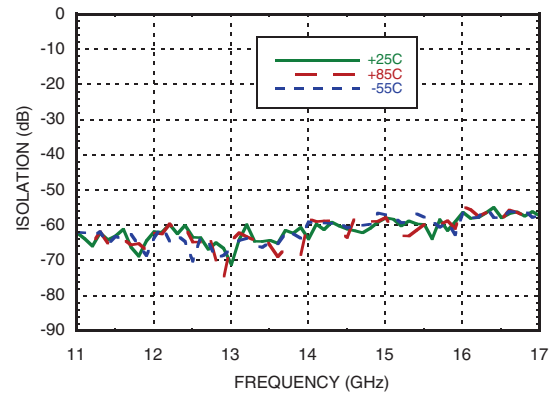

**Gain & Power vs. Supply Current @ 11.5 GHz**

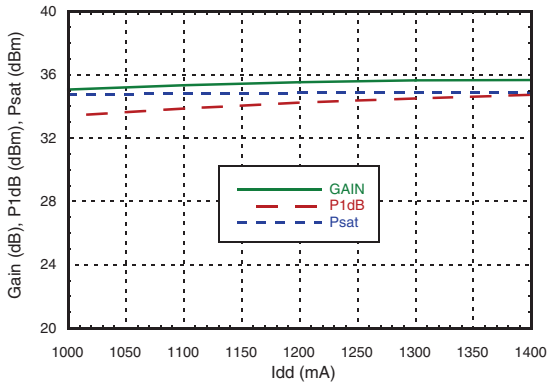

**Gain & Power vs. Supply Voltage @ 11.5 GHz**

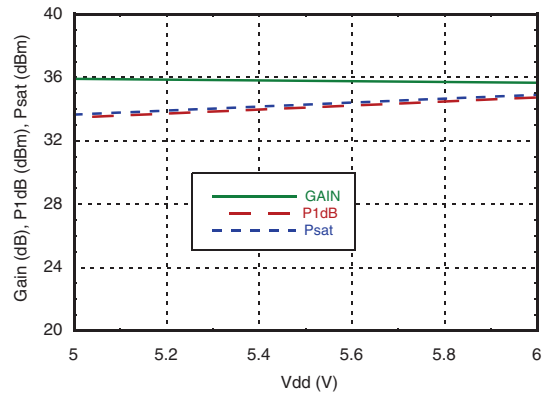

Information furnished by Analog Devices is believed to be accurate and reliable. However, no responsibility is assumed by Analog Devices for its use, nor for any infringements of patents or other rights of third parties that may result from its use. Specifications subject to change without notice. No license is granted by implication or otherwise under any patent or patent rights of Analog Devices. Trademarks and registered trademarks are the property of their respective owners.

For price, delivery, and to place orders: Analog Devices, Inc., One Technology Way, P.O. Box 9106, Norwood, MA 02062-9106 Phone: 781-329-4700 • Order online at [www.analog.com](http://www.analog.com) Application Support: Phone: 1-800-ANALOG-D



v02.0813

## GaAs pHEMT MMIC 2 WATT POWER AMPLIFIER WITH POWER DETECTOR, 9 - 14 GHz

### Power Dissipation

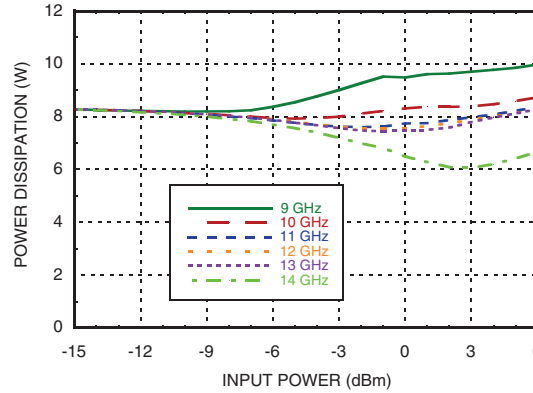

### Absolute Maximum Ratings

Drain Bias Voltage (Vdd)	+8V
Gate Bias Voltage (Vgg)	-3 ~ 0 Vdc
RF Input Power (RFIN)	+24 dBm
Channel Temperature	150 °C
Continuous P <sub>diss</sub> (T= 85 °C) (derate 133 mW/°C above 85 °C)	8.6 W
Thermal Resistance (channel to die bottom)	7.5 °C/W
Storage Temperature	-65 to +150 °C
Operating Temperature	-55 to +85 °C
ESD sensitivity (HBM)	Class 0, Passed 150V

### Typical Supply Current vs. Vdd

Vdd (V)	I <sub>dd</sub> (mA)
+5.0	1400
+6.0	1400
+7.0	1200

Note: Amplifier will operate over full voltage ranges shown above. V<sub>gg</sub> adjusted to achieve I<sub>dd</sub> = 1400 mA at +6V. V<sub>gg</sub> adjusted to achieve I<sub>dd</sub> = 1200 mA at +7V



ELECTROSTATIC SENSITIVE DEVICE  
OBSERVE HANDLING PRECAUTIONS

**GaAs pHEMT MMIC 2 WATT POWER AMPLIFIER  
WITH POWER DETECTOR, 9 - 14 GHz**



**Outline Drawing**

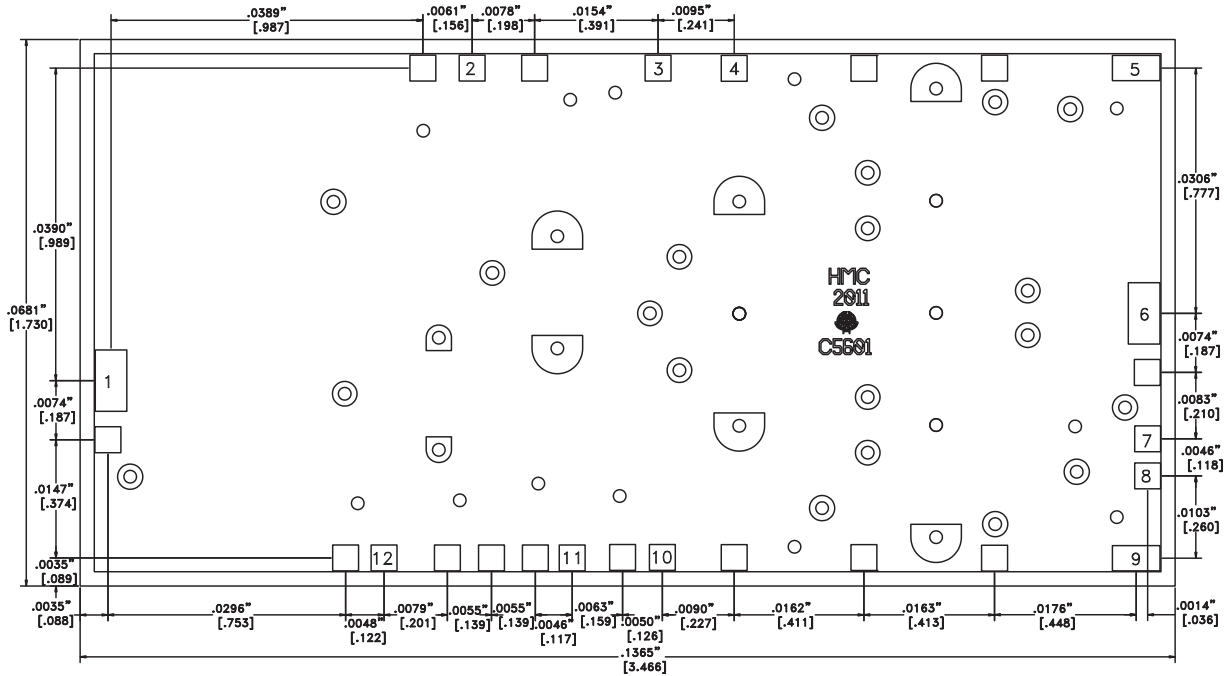

**NOTES:**

1. ALL DIMENSIONS ARE IN INCHES [MM]
2. DIE THICKNESS IS .004"
3. TYPICAL BOND PAD IS .0032" SQUARE
4. TYPICAL RF BOND PAD IS .0039 X .0076"
5. BACKSIDE METALLIZATION: GOLD
6. BOND PAD METALLIZATION: GOLD
7. BACKSIDE METAL IS GROUND.
8. CONNECTION NOT REQUIRED FOR UNLABELED BOND PADS.
9. OVERALL DIE SIZE ± .002"

**Die Packaging Information [1]**

Standard	Alternate
GP-1 (Gel Pack)	[2]



[1] Refer to the "Packaging Information" section for die packaging dimensions.

[2] For alternate packaging information contact Hittite Microwave Corporation.

## GaAs pHEMT MMIC 2 WATT POWER AMPLIFIER WITH POWER DETECTOR, 9 - 14 GHz

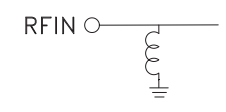
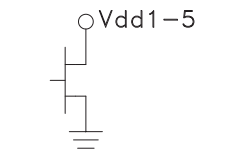
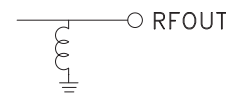
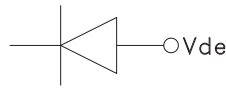
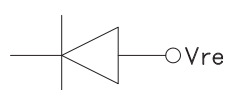
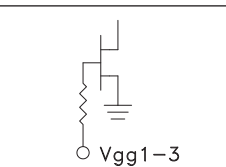

### Pad Descriptions

Pad Number	Function	Description	Interface Schematic
1	RFIN	This pad is DC coupled and matched to 50 Ohms.	
2 - 5, 9	Vdd1, Vdd2, Vdd3, Vdd4, Vdd5	Drain bias voltage for amplifier. External bypass capacitors of 100pF, 10nF, and 4.7uF are required.	
6	RFOUT	This pad is DC coupled and matched to 50 Ohms.	
7	Vdet	DC voltage representing RF output power rectified by diode which is biased through an external resistor. See application circuit.	
8	Vref	DC bias of diode biased through external resistor, used for temperature compensation of Vdet. See application circuit	
10 - 12	Vgg3, Vgg2, Vgg1	Gate control for amplifier. External bypass capacitors of 100pF and 100nF are required	
Die Bottom	GND	Die bottom must be connected to RF/DC ground.	



**GaAs pHEMT MMIC 2 WATT POWER AMPLIFIER  
WITH POWER DETECTOR, 9 - 14 GHz**



**Application Circuit**

**AMPLIFIERS - LINEAR & POWER - CHIP**

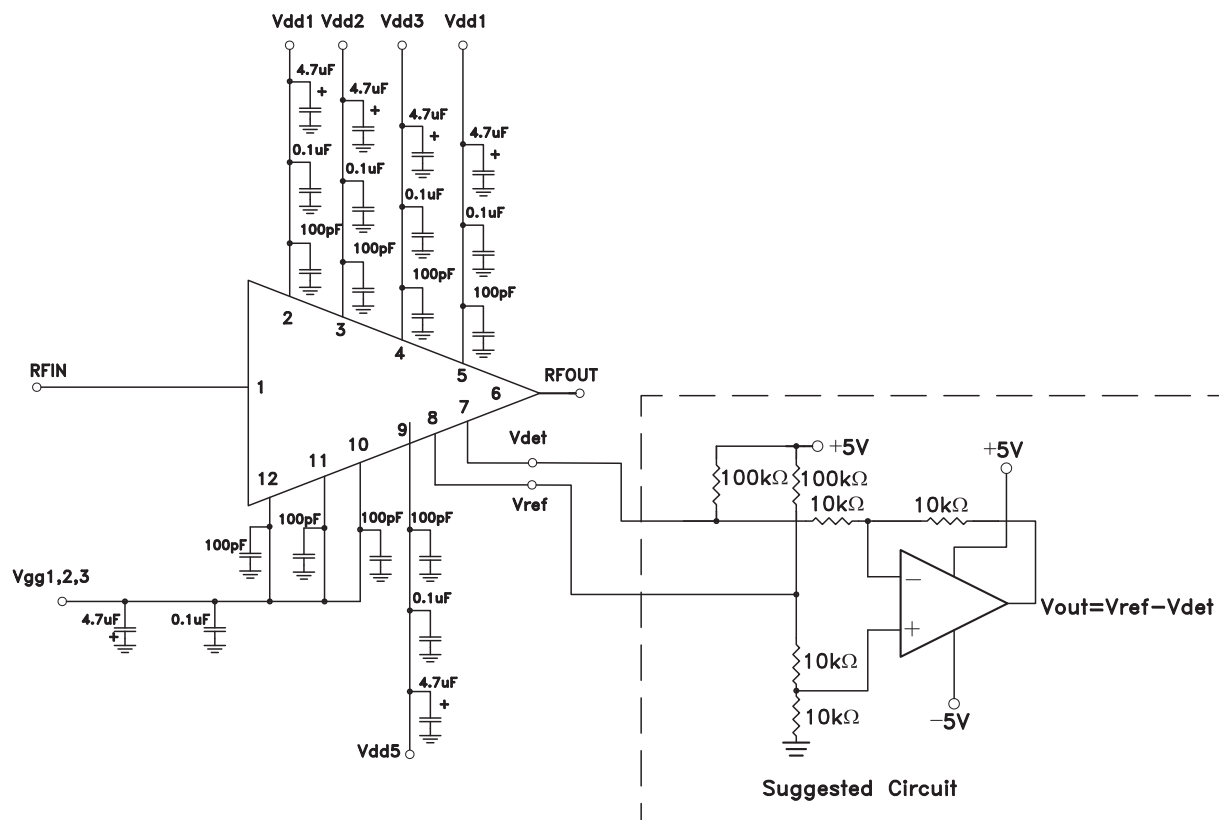

Information furnished by Analog Devices is believed to be accurate and reliable. However, no responsibility is assumed by Analog Devices for its use, nor for any infringements of patents or other rights of third parties that may result from its use. Specifications subject to change without notice. No license is granted by implication or otherwise under any patent or patent rights of Analog Devices. Trademarks and registered trademarks are the property of their respective owners.

For price, delivery, and to place orders: Analog Devices, Inc., One Technology Way, P.O. Box 9106, Norwood, MA 02062-9106 Phone: 781-329-4700 • Order online at [www.analog.com](http://www.analog.com) Application Support: Phone: 1-800-ANALOG-D



v02.0813

**GaAs pHEMT MMIC 2 WATT POWER AMPLIFIER  
WITH POWER DETECTOR, 9 - 14 GHz**

**Assembly Diagram**

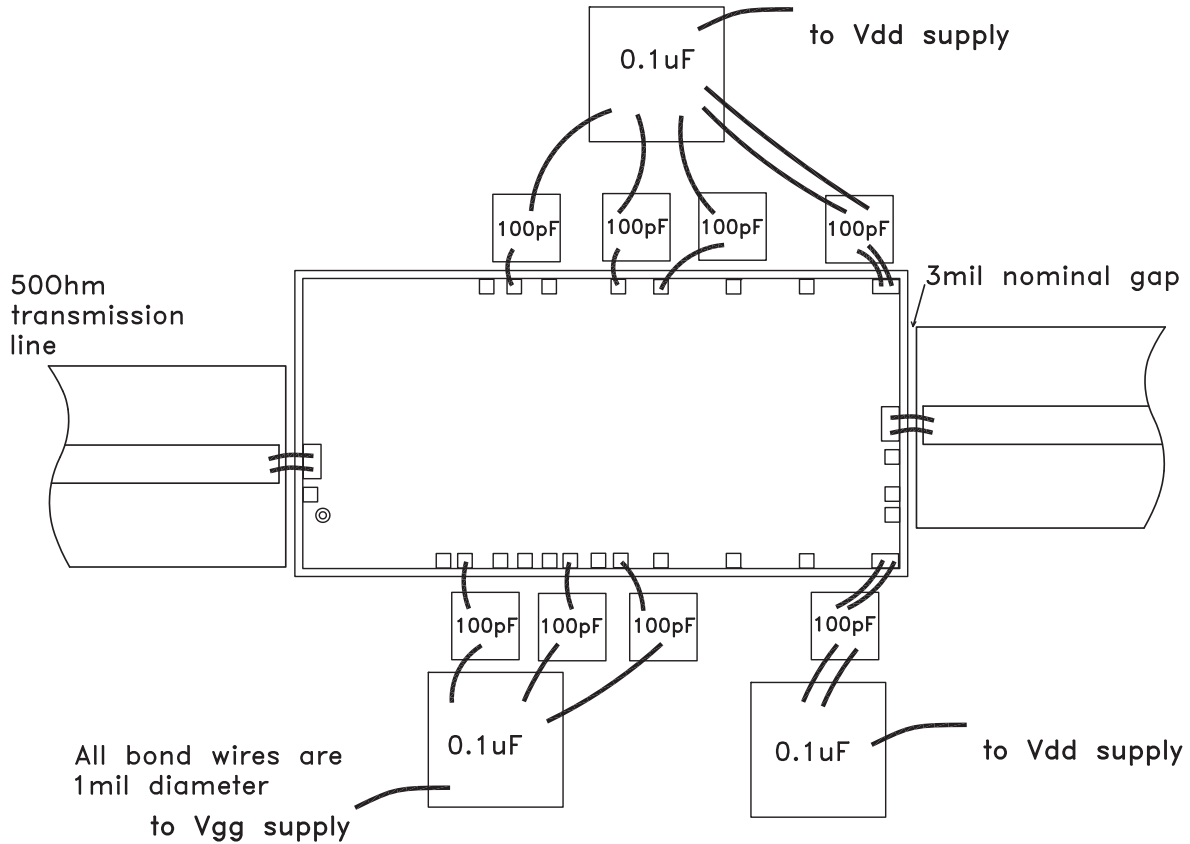

Information furnished by Analog Devices is believed to be accurate and reliable. However, no responsibility is assumed by Analog Devices for its use, nor for any infringements of patents or other rights of third parties that may result from its use. Specifications subject to change without notice. No license is granted by implication or otherwise under any patent or patent rights of Analog Devices. Trademarks and registered trademarks are the property of their respective owners.

For price, delivery, and to place orders: Analog Devices, Inc., One Technology Way, P.O. Box 9106, Norwood, MA 02062-9106 Phone: 781-329-4700 • Order online at [www.analog.com](http://www.analog.com) Application Support: Phone: 1-800-ANALOG-D

## GaAs pHEMT MMIC 2 WATT POWER AMPLIFIER WITH POWER DETECTOR, 9 - 14 GHz



### Mounting & Bonding Techniques for Millimeterwave GaAs MMICs

The die should be attached directly to the ground plane eutectically or with conductive epoxy (see HMC general Handling, Mounting, Bonding Note).

50 Ohm Microstrip transmission lines on 0.127mm (5 mil) thick alumina thin film substrates are recommended for bringing RF to and from the chip (Figure 1). If 0.254mm (10 mil) thick alumina thin film substrates must be used, the die should be raised 0.150mm (6 mils) so that the surface of the die is coplanar with the surface of the substrate. One way to accomplish this is to attach the 0.102mm (4 mil) thick die to a 0.150mm (6 mil) thick molybdenum heat spreader (moly-tab) which is then attached to the ground plane (Figure 2).

Microstrip substrates should be located as close to the die as possible in order to minimize bond wire length. Typical die-to-substrate spacing is 0.076mm to 0.152 mm (3 to 6 mils).

#### Handling Precautions

Follow these precautions to avoid permanent damage.

**Storage:** All bare die are placed in either Waffle or Gel based ESD protective containers, and then sealed in an ESD protective bag for shipment. Once the sealed ESD protective bag has been opened, all die should be stored in a dry nitrogen environment.

**Cleanliness:** Handle the chips in a clean environment. DO NOT attempt to clean the chip using liquid cleaning systems.

**Static Sensitivity:** Follow ESD precautions to protect against  $> \pm 250V$  ESD strikes.

**Transients:** Suppress instrument and bias supply transients while bias is applied. Use shielded signal and bias cables to minimize inductive pick-up.

**General Handling:** Handle the chip along the edges with a vacuum collet or with a sharp pair of bent tweezers. The surface of the chip may have fragile air bridges and should not be touched with vacuum collet, tweezers, or fingers.

#### Mounting

The chip is back-metallized and can be die mounted with AuSn eutectic preforms or with electrically conductive epoxy. The mounting surface should be clean and flat.

**Eutectic Die Attach:** A 80/20 gold tin preform is recommended with a work surface temperature of 255 °C and a tool temperature of 265 °C. When hot 90/10 nitrogen/hydrogen gas is applied, tool tip temperature should be 290 °C. DO NOT expose the chip to a temperature greater than 320 °C for more than 20 seconds. No more than 3 seconds of scrubbing should be required for attachment.

**Epoxy Die Attach:** Apply a minimum amount of epoxy to the mounting surface so that a thin epoxy fillet is observed around the perimeter of the chip once it is placed into position. Cure epoxy per the manufacturer's schedule.

#### Wire Bonding

Ball or wedge bond with 0.025mm (1 mil) diameter pure gold wire. Thermosonic wirebonding with a nominal stage temperature of 150 °C and a ball bonding force of 40 to 50 grams or wedge bonding force of 18 to 22 grams is recommended. Use the minimum level of ultrasonic energy to achieve reliable wirebonds. Wirebonds should be started on the chip and terminated on the package or substrate. All bonds should be as short as possible  $< 0.31mm$  (12 mils).

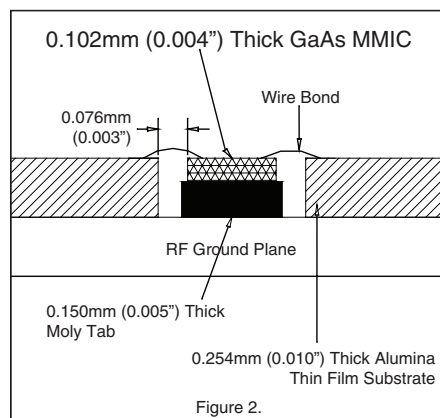
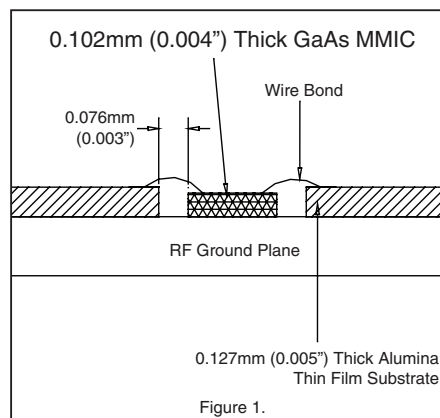



Notes:

HMC952

v02.0813

**GaAs pHEMT MMIC 2 WATT POWER AMPLIFIER  
WITH POWER DETECTOR, 9 - 14 GHz**