

MIRA-WW

~60° wide medium beam optimized for LUXEON M/MX. Assembly with holder and installation tape.

TECHNICAL SPECIFICATIONS:

Dimensions	Ø 35.0 mm
Height	15.8 mm
Fastening	tape
Colour	white
Box size	480 x 280 x 300 mm
Box weight	10.4 kg
Quantity in Box	840 pcs
ROHS compliant	yes ⓘ



MATERIAL SPECIFICATIONS:

Component	Type	Material	Colour
MIRA-WW	Lens	PC	clear
MINNIE-HLD-M-WHT	Holder	PC	white
SPUTNIK-TAPE	Tape	Acrylic tape	black

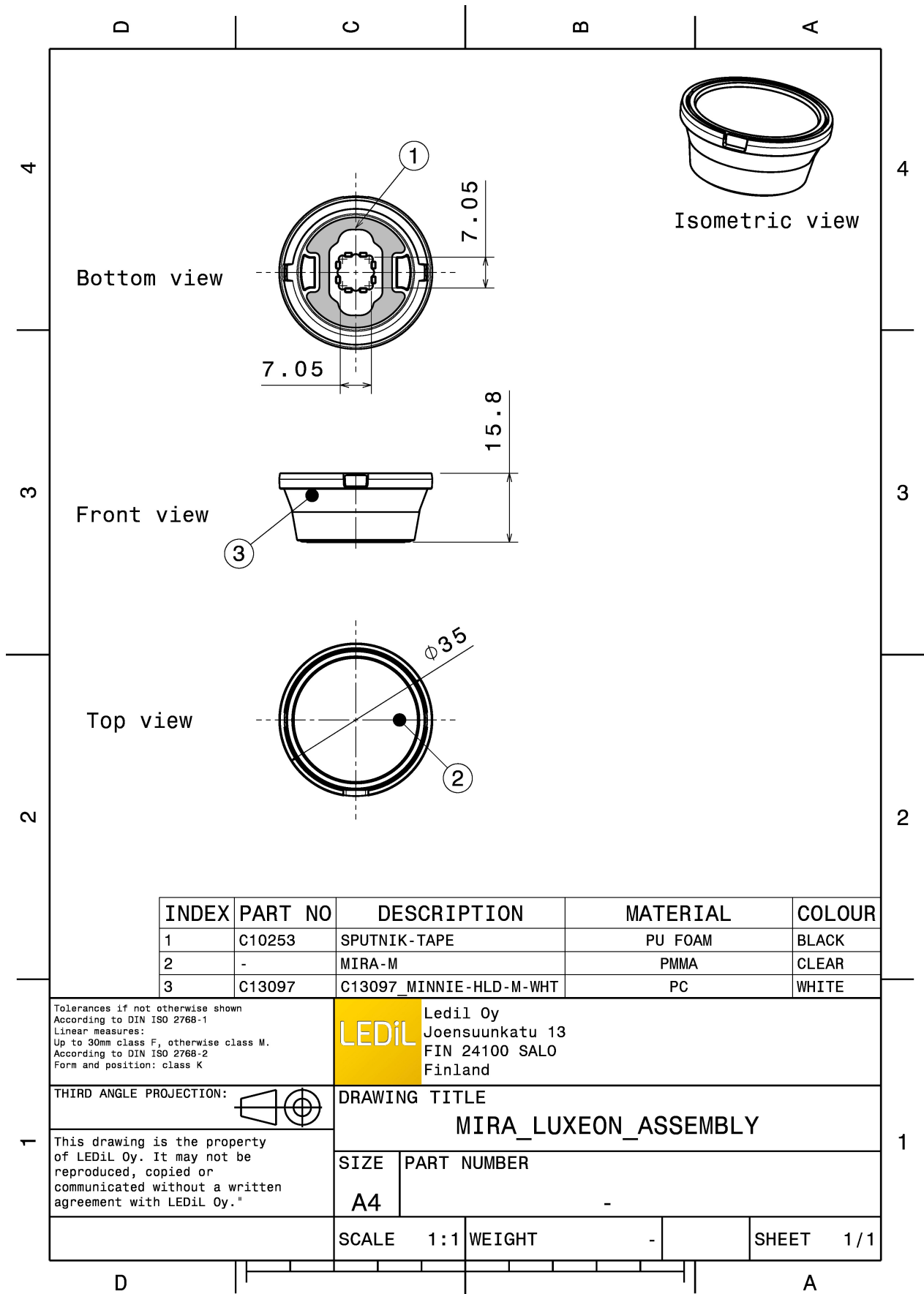

PHOTOMETRIC DATA (MEASURED):



LED MHD-E/G
 FWHM 61.0°
 Efficiency 81 %
 Peak intensity 0.730 cd/lm
 Required components:

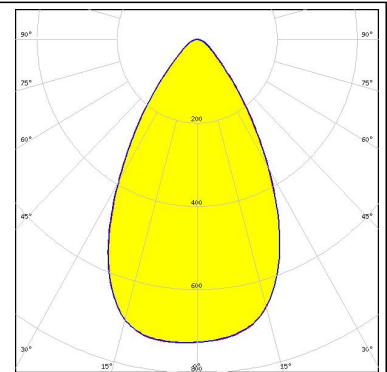
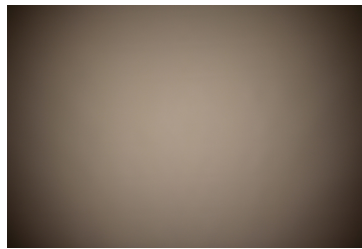

LED MK-R
 FWHM 60.0°
 Efficiency 80 %
 Peak intensity 0.800 cd/lm
 Required components:

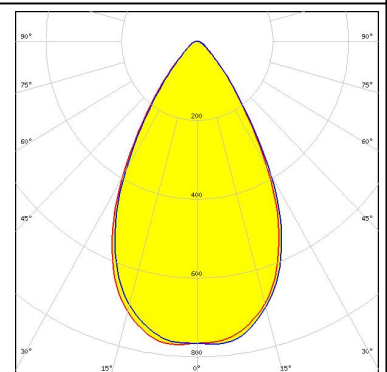
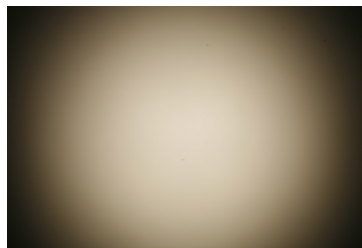

LED XHP70
 FWHM 61.0°
 Efficiency 82 %
 Peak intensity 0.760 cd/lm
 Required components:

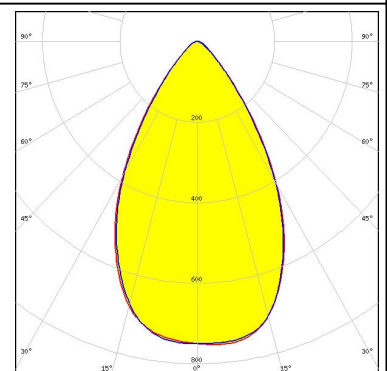
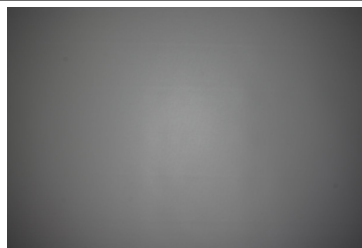

LED LUXEON M/MX
 FWHM 57.0°
 Efficiency 82 %
 Peak intensity 0.800 cd/lm
 Required components:

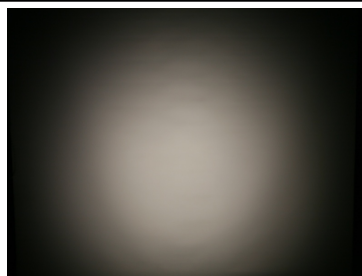

PHOTOMETRIC DATA (SIMULATED):



LED XHP70.2
FWHM 64.5°
Efficiency 72 %
Peak intensity 0.700 cd/lm
Required components:

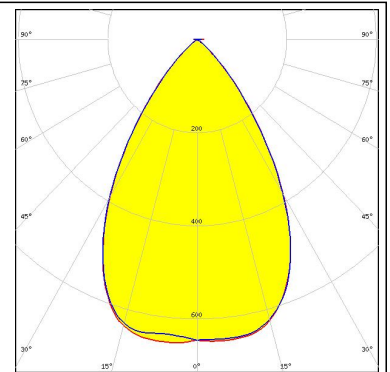

LED OSCONIQ P 7070
FWHM 53.0°
Efficiency 86 %
Peak intensity 1.100 cd/lm
Required components:

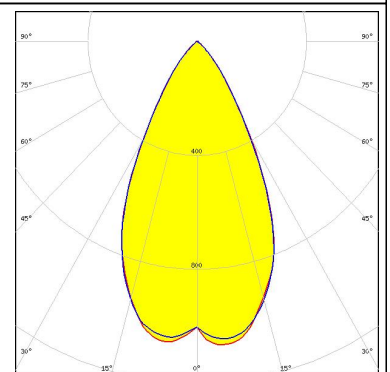

GENERAL INFORMATION:

NOTE: The typical beam angle will be changed by different color, chip size and chip position tolerance. The typical total beam angle is the full angle measured where the luminous intensity is half of the peak value.

MATERIALS:

As part of our continuous research and improvement processes, and to ensure the best possible quality and availability of our products, LEDiL reserves the right to change material grades without notice.

PRODUCT DATA USER AGREEMENT AND DISCLAIMER:

The measured data in the provided downloadable LEDiL Product Datasheets and Mechanical 2D-Drawings is rounded and provided as reference for planning. LEDiL Oy's optical specifications have been verified by conducting performance testing of the products in accordance with the company's quality system. The reported data are averaged results of multiple measurements with typical variation. LEDiL Oy reserves the right to without prior notification make changes and improvements to its products.

LEDiL Oy assumes neither warranty, nor guarantee nor any other liability of any kind for the contents and correctness of the provided data. The provided data has been generated with highest diligence but the provided data may in reality not represent the complete possible variation range of all intrinsic parameters. Therefore, in certain cases a deviation from the provided data could occur.

LEDiL Oy reserves the right to undertake technical changes of its products without further notification which could lead to changes in the provided data. LEDiL Oy assumes no liability of any kind for the possible deviation from any provided data or any other damage resulting from the usage of the provided data.

The user agrees to this disclaimer and user agreement with the download or usage of the provided files.

LEDiL Oy

Joensuunkatu 13
FI-24240 SALO
Finland

LEDiL Inc.

228 West Page Street
Suite D
Sycamore IL 60178
USA

Local sales and technical support

[www.ledil.com/
where_to_buy](http://www.ledil.com/where_to_buy)

Shipping locations

Salo, Finland
Hong Kong, China

Distribution Partners

[www.ledil.com/
where_to_buy](http://www.ledil.com/where_to_buy)