

NTMS5P02, NVMS5P02

Power MOSFET -5.4 Amps, -20 Volts

P-Channel Enhancement-Mode Single SOIC-8 Package

Features

- High Density Power MOSFET with Ultra Low $R_{DS(on)}$ Providing Higher Efficiency
- Miniature SOIC-8 Surface Mount Package – Saves Board Space
- Diode Exhibits High Speed with Soft Recovery
- I_{DSS} Specified at Elevated Temperature
- Drain-to-Source Avalanche Energy Specified
- Mounting Information for the SOIC-8 Package is Provided
- These Devices are Pb-Free and are RoHS Compliant
- NVMS Prefix for Automotive and Other Applications Requiring Unique Site and Control Change Requirements; AEC-Q101 Qualified and PPAP Capable

Applications

- Power Management in Portable and Battery-Powered Products, i.e.: Computers, Printers, PCMCIA Cards, Cellular & Cordless Telephones



ON Semiconductor®

<http://onsemi.com>

V_{DSS}	$R_{DS(on)}$ TYP	I_D MAX
-20 V	26 mΩ @ -4.5 V	-5.4 A

Single P-Channel

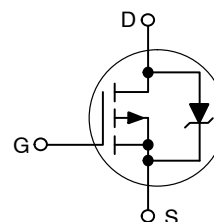

MARKING DIAGRAM & PIN ASSIGNMENT

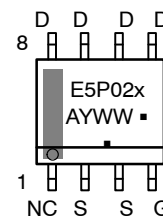

E5P02 = Specific Device Code
 x = Blank or S
 A = Assembly Location
 Y = Year
 WW = Work Week
 ■ = Pb-Free Package

(Note: Microdot may be in either location)

ORDERING INFORMATION

Device	Package	Shipping†
NTMS5P02R2G	SOIC-8 (Pb-Free)	2500 / Tape & Reel
NVMS5P02R2G	SOIC-8 (Pb-Free)	2500 / Tape & Reel

†For information on tape and reel specifications, including part orientation and tape sizes, please refer to our Tape and Reel Packaging Specifications Brochure, BRD8011/D

NTMS5P02, NVMS5P02

MAXIMUM RATINGS ($T_J = 25^\circ\text{C}$ unless otherwise noted)

Rating	Symbol	Value	Unit
Drain-to-Source Voltage	V_{DSS}	-20	V
Drain-to-Gate Voltage ($R_{GS} = 1.0\ \text{m}\Omega$)	V_{DGR}	-20	V
Gate-to-Source Voltage – Continuous	V_{GS}	± 10	V
Thermal Resistance – Junction-to-Ambient (Note 1) Total Power Dissipation @ $T_A = 25^\circ\text{C}$ Continuous Drain Current @ 25°C Continuous Drain Current @ 70°C Maximum Operating Power Dissipation Maximum Operating Drain Current Pulsed Drain Current (Note 4)	$R_{\theta JA}$ P_D I_D I_D P_D I_D I_{DM}	50 2.5 -7.05 -5.62 1.2 -4.85 -28	$^\circ\text{C/W}$ W A A W A A
Thermal Resistance – Junction-to-Ambient (Note 2) Total Power Dissipation @ $T_A = 25^\circ\text{C}$ Continuous Drain Current @ 25°C Continuous Drain Current @ 70°C Maximum Operating Power Dissipation Maximum Operating Drain Current Pulsed Drain Current (Note 4)	$R_{\theta JA}$ P_D I_D I_D P_D I_D I_{DM}	85 1.47 -5.40 -4.30 0.7 -3.72 -20	$^\circ\text{C/W}$ W A A W A A
Thermal Resistance – Junction-to-Ambient (Note 3) Total Power Dissipation @ $T_A = 25^\circ\text{C}$ Continuous Drain Current @ 25°C Continuous Drain Current @ 70°C Maximum Operating Power Dissipation Maximum Operating Drain Current Pulsed Drain Current (Note 4)	$R_{\theta JA}$ P_D I_D I_D P_D I_D I_{DM}	159 0.79 -3.95 -3.15 0.38 -2.75 -12	$^\circ\text{C/W}$ W A A W A A
Operating and Storage Temperature Range	T_J, T_{stg}	-55 to +150	$^\circ\text{C}$
Single Pulse Drain-to-Source Avalanche Energy – Starting $T_J = 25^\circ\text{C}$ ($V_{DD} = -20\ \text{Vdc}$, $V_{GS} = -5.0\ \text{Vdc}$, Peak $I_L = -8.5\ \text{Apk}$, $L = 10\ \text{mH}$, $R_G = 25\ \Omega$)	E_{AS}	360	mJ
Maximum Lead Temperature for Soldering Purposes, 1/8" from case for 10 seconds	T_L	260	$^\circ\text{C}$

Stresses exceeding Maximum Ratings may damage the device. Maximum Ratings are stress ratings only. Functional operation above the Recommended Operating Conditions is not implied. Extended exposure to stresses above the Recommended Operating Conditions may affect device reliability.

1. Mounted onto a 2" square FR-4 Board (1" sq. 2 oz Cu 0.06" thick single sided), $t \leq 10$ seconds.
2. Mounted onto a 2" square FR-4 Board (1" sq. 2 oz Cu 0.06" thick single sided), $t =$ steady state.
3. Minimum FR-4 or G-10 PCB, $t =$ Steady State.
4. Pulse Test: Pulse Width = 300 μs , Duty Cycle = 2%.

NTMS5P02, NVMS5P02

ELECTRICAL CHARACTERISTICS (T_C = 25°C unless otherwise noted) (Note 5)

Characteristic	Symbol	Min	Typ	Max	Unit
----------------	--------	-----	-----	-----	------

OFF CHARACTERISTICS

Drain-to-Source Breakdown Voltage (V _{GS} = 0 Vdc, I _D = -250 μAdc) Temperature Coefficient (Positive)	V _{(BR)DSS}	-20 -	- -15	- -	Vdc mV/°C
Zero Gate Voltage Drain Current (V _{DS} = -16 Vdc, V _{GS} = 0 Vdc, T _J = 25°C) (V _{DS} = -16 Vdc, V _{GS} = 0 Vdc, T _J = 125°C) (V _{DS} = -20 Vdc, V _{GS} = 0 Vdc, T _J = 25°C)	I _{DSS}	- - -	- - -0.2	-1.0 -10 -	μAdc
Gate-Body Leakage Current (V _{GS} = -10 Vdc, V _{DS} = 0 Vdc)	I _{GSS}	-	-	-100	nAdc
Gate-Body Leakage Current (V _{GS} = +10 Vdc, V _{DS} = 0 Vdc)	I _{GSS}	-	-	100	nAdc

ON CHARACTERISTICS

Gate Threshold Voltage (V _{DS} = V _{GS} , I _D = -250 μAdc) Temperature Coefficient (Negative)	V _{GS(th)}	-0.65 -	-0.9 2.9	-1.25 -	Vdc mV/°C
Static Drain-to-Source On-State Resistance (V _{GS} = -4.5 Vdc, I _D = -5.4 Adc) (V _{GS} = -2.5 Vdc, I _D = -2.7 Adc)	R _{DS(on)}	- -	0.026 0.037	0.033 0.048	Ω
Forward Transconductance (V _{DS} = -9.0 Vdc, I _D = -5.4 Adc)	g _{FS}	-	15	-	Mhos

DYNAMIC CHARACTERISTICS

Input Capacitance	(V _{DS} = -16 Vdc, V _{GS} = 0 Vdc, f = 1.0 MHz)	C _{ISS}	-	1375	1900	pF
Output Capacitance		C _{OSS}	-	510	900	
Reverse Transfer Capacitance		C _{RSS}	-	200	380	

SWITCHING CHARACTERISTICS (Notes 6 & 7)

Turn-On Delay Time	(V _{DD} = -16 Vdc, I _D = -1.0 Adc, V _{GS} = -4.5 Vdc, R _G = 6.0 Ω)	t _{d(on)}	-	18	35	ns
Rise Time		t _r	-	25	50	
Turn-Off Delay Time		t _{d(off)}	-	70	125	
Fall Time		t _f	-	55	100	
Turn-On Delay Time	(V _{DD} = -16 Vdc, I _D = -5.4 Adc, V _{GS} = -4.5 Vdc, R _G = 6.0 Ω)	t _{d(on)}	-	22	-	ns
Rise Time		t _r	-	70	-	
Turn-Off Delay Time		t _{d(off)}	-	65	-	
Fall Time		t _f	-	90	-	
Total Gate Charge	(V _{DS} = -16 Vdc, V _{GS} = -4.5 Vdc, I _D = -5.4 Adc)	Q _{tot}	-	20	35	nC
Gate-Source Charge		Q _{gs}	-	4.0	-	
Gate-Drain Charge		Q _{gd}	-	7.0	-	

BODY-DRAIN DIODE RATINGS (Note 6)

Diode Forward On-Voltage	(I _S = -5.4 Adc, V _{GS} = 0 V) (I _S = -5.4 Adc, V _{GS} = 0 Vdc, T _J = 125°C)	V _{SD}	- -	-0.95 -0.72	-1.25 -	Vdc
Reverse Recovery Time	(I _S = -5.4 Adc, V _{GS} = 0 Vdc, di _S /dt = 100 A/μs)	t _{rr}	-	40	75	ns
		t _a	-	20	-	
		t _b	-	20	-	
Reverse Recovery Stored Charge		Q _{RR}	-	0.03	-	μC

5. Handling precautions to protect against electrostatic discharge is mandatory.
6. Indicates Pulse Test: Pulse Width = 300 μs max, Duty Cycle = 2%.
7. Switching characteristics are independent of operating junction temperature.

NTMS5P02, NVMS5P02

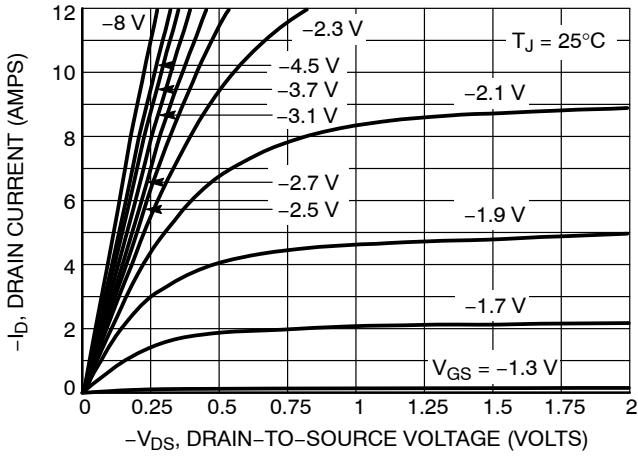

Figure 1. On-Region Characteristics

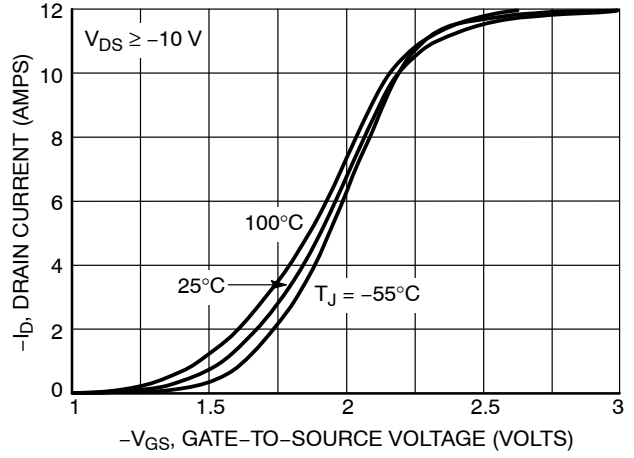

Figure 2. Transfer Characteristics

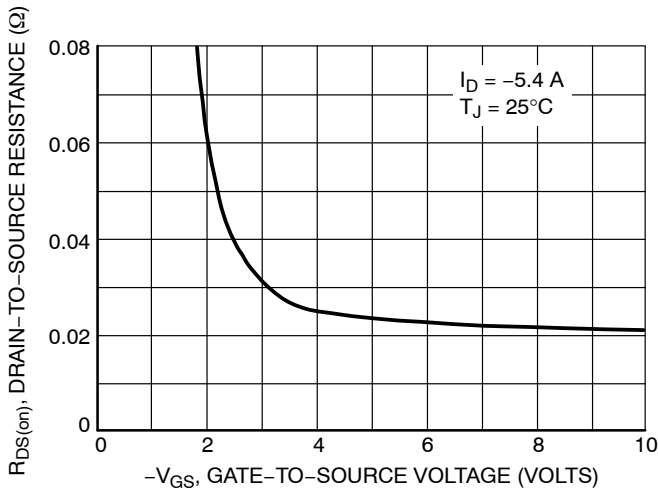

Figure 3. On-Resistance versus Gate-To-Source Voltage

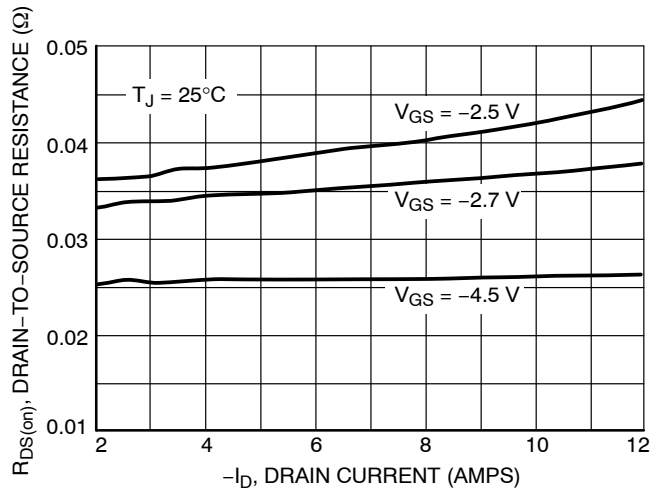

Figure 4. On-Resistance versus Drain Current and Gate Voltage

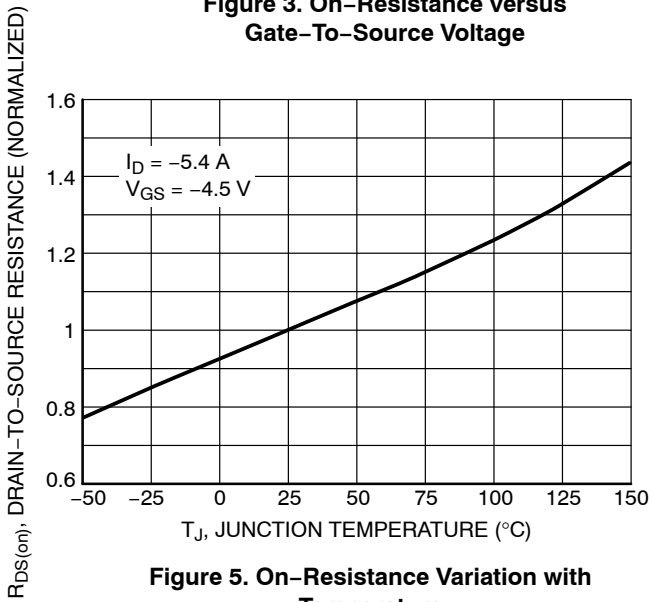

Figure 5. On-Resistance Variation with Temperature

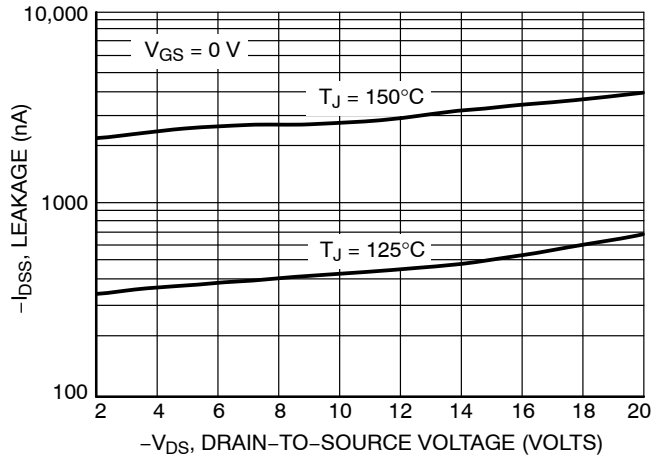

Figure 6. Drain-To-Source Leakage Current versus Voltage

NTMS5P02, NVMS5P02

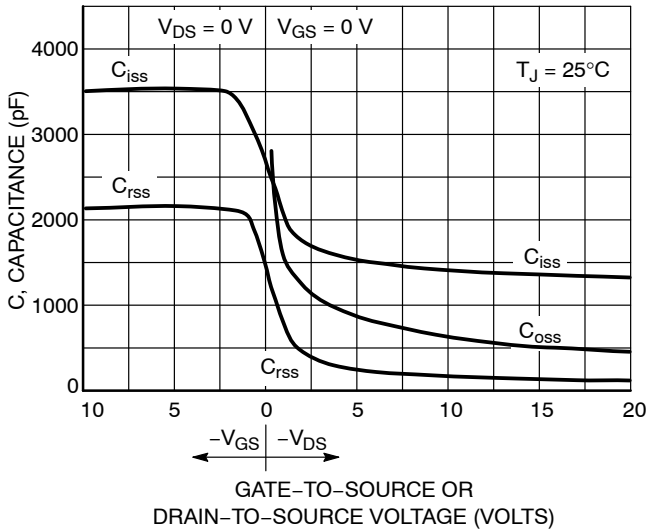

Figure 7. Capacitance Variation

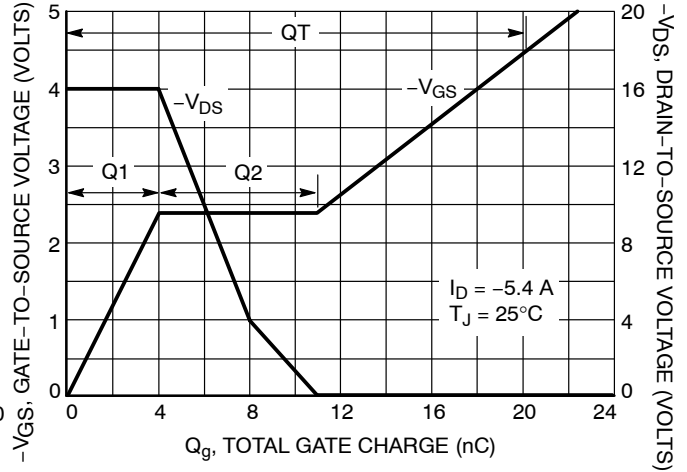

Figure 8. Gate-To-Source and Drain-To-Source Voltage versus Total Charge

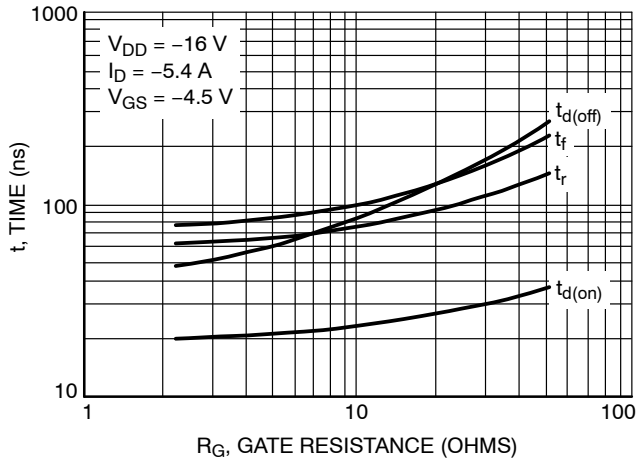

Figure 9. Resistive Switching Time Variation versus Gate Resistance

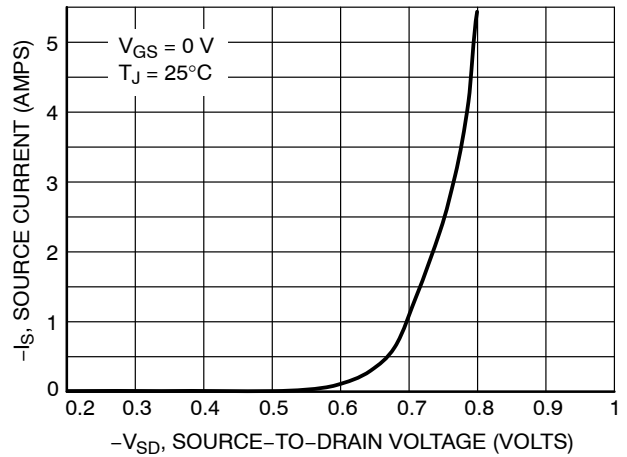

Figure 10. Diode Forward Voltage versus Current

DRAIN-TO-SOURCE DIODE CHARACTERISTICS

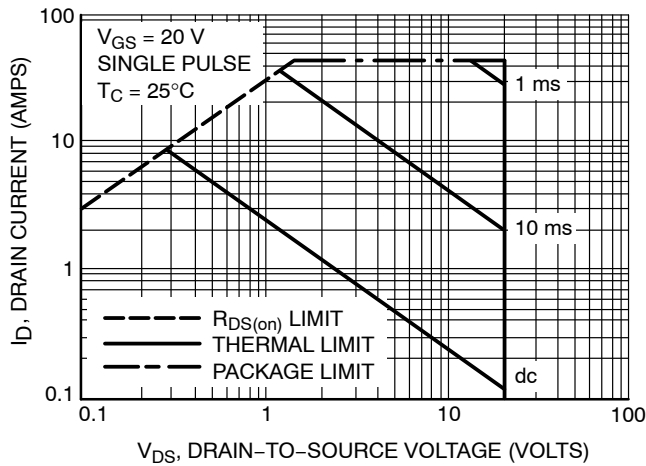

Figure 11. Maximum Rated Forward Biased Safe Operating Area

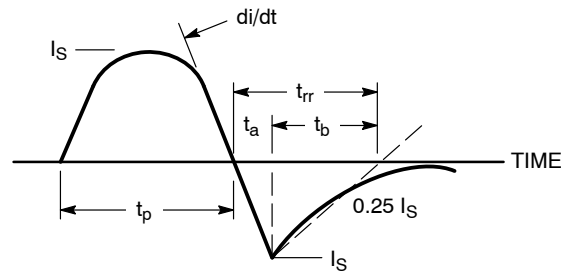

Figure 12. Diode Reverse Recovery Waveform

NTMS5P02, NVMS5P02

TYPICAL ELECTRICAL CHARACTERISTICS

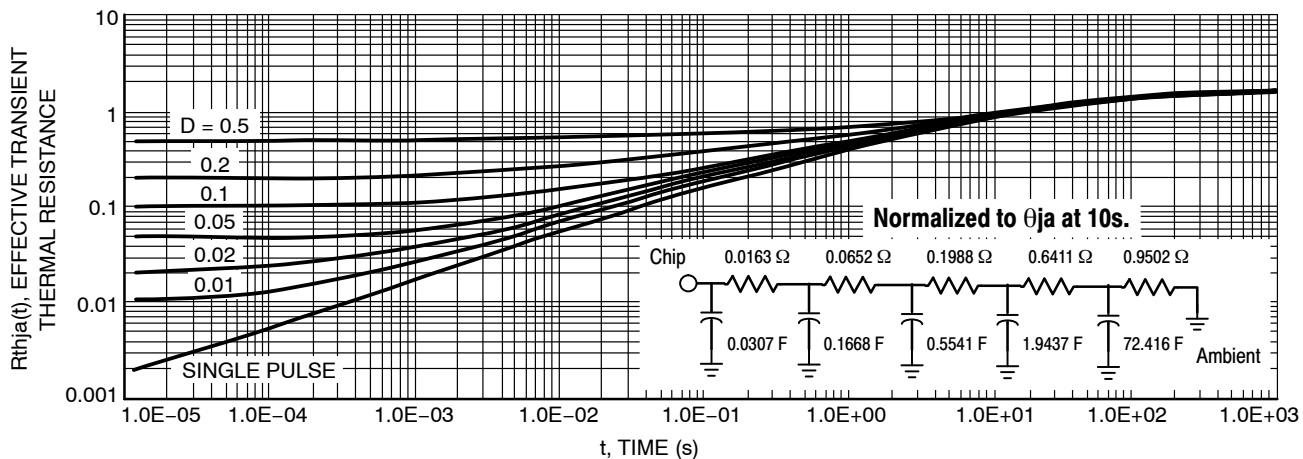
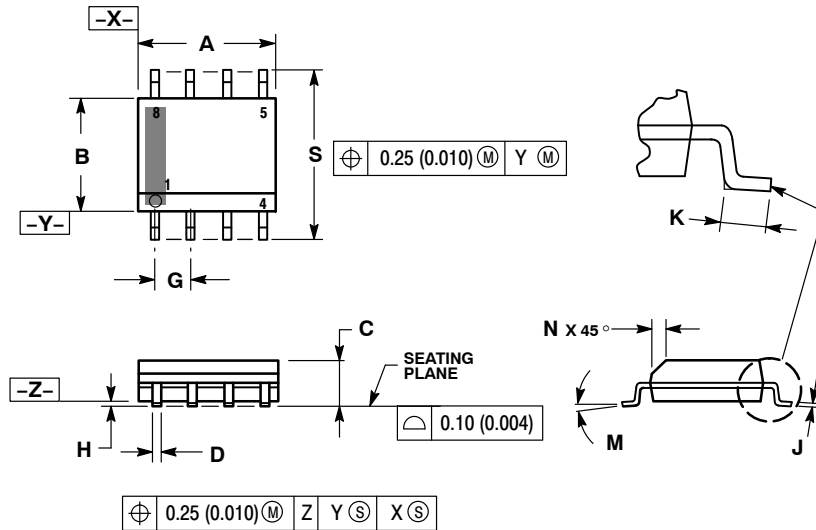

Figure 13. Thermal Response

NTMS5P02, NVMS5P02

PACKAGE DIMENSIONS

SOIC-8 NB
CASE 751-07
ISSUE AK



NOTES:

1. DIMENSIONING AND TOLERANCING PER ANSI Y14.5M, 1982.
2. CONTROLLING DIMENSION: MILLIMETER.
3. DIMENSION A AND B DO NOT INCLUDE MOLD PROTRUSION.
4. MAXIMUM MOLD PROTRUSION 0.15 (0.006) PER SIDE.
5. DIMENSION D DOES NOT INCLUDE DAMBAR PROTRUSION. ALLOWABLE DAMBAR PROTRUSION SHALL BE 0.127 (0.005) TOTAL IN EXCESS OF THE D DIMENSION AT MAXIMUM MATERIAL CONDITION.
6. 751-01 THRU 751-06 ARE OBSOLETE. NEW STANDARD IS 751-07.

DIM	MILLIMETERS		INCHES	
	MIN	MAX	MIN	MAX
A	4.80	5.00	0.189	0.197
B	3.80	4.00	0.150	0.157
C	1.35	1.75	0.053	0.069
D	0.33	0.51	0.013	0.020
G	1.27 BSC		0.050 BSC	
H	0.10	0.25	0.004	0.010
J	0.19	0.25	0.007	0.010
K	0.40	1.27	0.016	0.050
M	0°	8°	0°	8°
N	0.25	0.50	0.010	0.020
S	5.80	6.20	0.228	0.244

STYLE 13:

- PIN 1: N.C.
 2. SOURCE
 3. SOURCE
 4. GATE
 5. DRAIN
 6. DRAIN
 7. DRAIN
 8. DRAIN

SOLDERING FOOTPRINT*

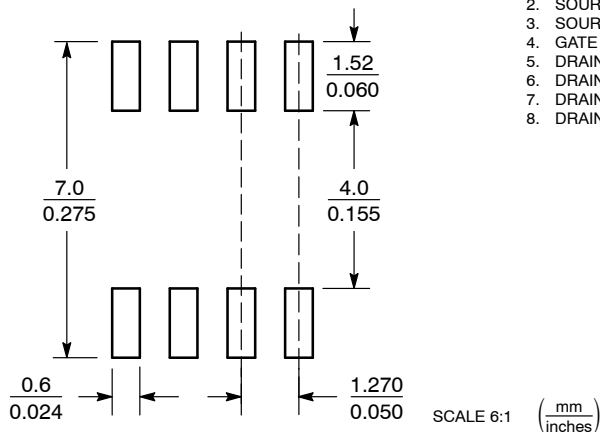

*For additional information on our Pb-Free strategy and soldering details, please download the ON Semiconductor Soldering and Mounting Techniques Reference Manual, SOLDERRM/D.

ON Semiconductor and are registered trademarks of Semiconductor Components Industries, LLC (SCILLC). SCILLC reserves the right to make changes without further notice to any products herein. SCILLC makes no warranty, representation or guarantee regarding the suitability of its products for any particular purpose, nor does SCILLC assume any liability arising out of the application or use of any product or circuit, and specifically disclaims any and all liability, including without limitation special, consequential or incidental damages. "Typical" parameters which may be provided in SCILLC data sheets and/or specifications can and do vary in different applications and actual performance may vary over time. All operating parameters, including "Typicals" must be validated for each customer application by customer's technical experts. SCILLC does not convey any license under its patent rights nor the rights of others. SCILLC products are not designed, intended, or authorized for use as components in systems intended for surgical implant into the body, or other applications intended to support or sustain life, or for any other application in which the failure of the SCILLC product could create a situation where personal injury or death may occur. Should Buyer purchase or use SCILLC products for any such unintended or unauthorized application, Buyer shall indemnify and hold SCILLC and its officers, employees, subsidiaries, affiliates, and distributors harmless against all claims, costs, damages, and expenses, and reasonable attorney fees arising out of, directly or indirectly, any claim of personal injury or death associated with such unintended or unauthorized use, even if such claim alleges that SCILLC was negligent regarding the design or manufacture of the part. SCILLC is an Equal Opportunity/Affirmative Action Employer. This literature is subject to all applicable copyright laws and is not for resale in any manner.

PUBLICATION ORDERING INFORMATION

LITERATURE FULFILLMENT:
 Literature Distribution Center for ON Semiconductor
 P.O. Box 5163, Denver, Colorado 80217 USA
 Phone: 303-675-2175 or 800-344-3860 Toll Free USA/Canada
 Fax: 303-675-2176 or 800-344-3867 Toll Free USA/Canada
 Email: orderlit@onsemi.com

N. American Technical Support: 800-282-9855 Toll Free
 USA/Canada
 Europe, Middle East and Africa Technical Support:
 Phone: 421 33 790 2910
 Japan Customer Focus Center
 Phone: 81-3-5817-1050

ON Semiconductor Website: www.onsemi.com
 Order Literature: <http://www.onsemi.com/orderlit>

For additional information, please contact your local Sales Representative