



An Integrated Device Technology, Inc. Company

Model: FXTC-HE73 Series Preliminary

HCMOS 7 x 5mm 3.3V TCXO **Freq: 0.75 MHz to 250MHz**



Features

- ✔ EXTREMELY Low Jitter
- ✔ XPRESSO Delivery
- ✔ Frequency Resolution to six decimal places
- ✔ -40 to +85°C operating temperatures
- ✔ Tri-State Enable / Disable Feature
- ✔ Industry Standard Package, Footprint & Pin-Out
- ✔ Fully RoHS compliant
- ✔ Serial ID with Comprehensive Traceability



Applications

- Medical Monitoring and Measurement
- Telecom and Networking
- Test and Measurement Detection, Sensing, and Metering
- Military Communications
- Signal Processing and Data acquisition.

Description

XPRESSO-TC is a breakthrough in configurable Frequency Control Solutions. XPRESSO-TC utilizes a family of proprietary ASICs, designed and developed by Fox, with a key focus on noise reduction technologies and tight temperature stability.

The 3rd order Delta Sigma Modulator reduces noise to the levels that are comparable to traditional Bulk Quartz and SAW oscillators.

With short lead-time, low cost, low noise, wide frequency range, and excellent temperature performance, XPRESSO-TC is an ideal choice over the conventional technologies.

Finished XPRESSO-TC parts are 100% final tested.

Contents

	page
Model Selection & Part Number Guide	2
Absolute Maximums	3
Electrical Characteristics	3
Output Wave Characteristics	4
Phase Noise	5
Jitter	5
Pin Assignment	6
Recommended Circuit	6
Reflow	6
Mechanical Drawing and Pad Layout	7
Tape and Reel Specification	8
Label	8
Traceability – LOT Number & Serial Identification	9
Environmental Test	10
Fox Contact Information	11



Model Selection Guide & Fox Part Number

STEP #1: Customer selects the Model Description and provides to Fox Customer Service
Model Description

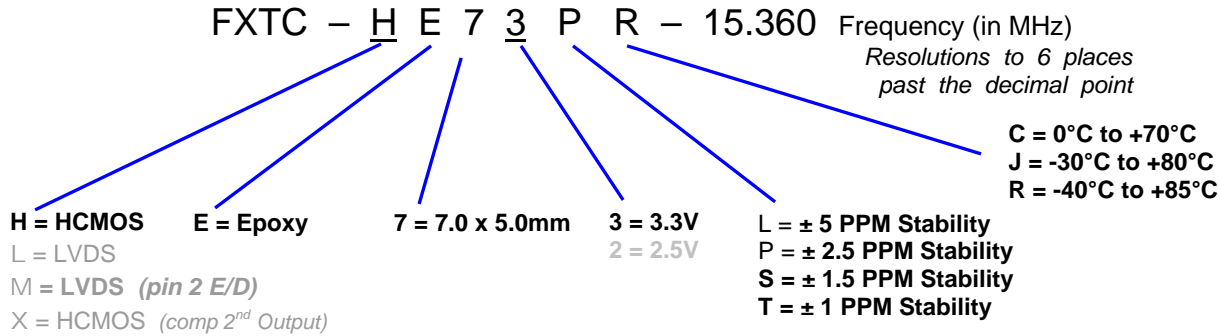

*Not all stability and operating temps possible

STEP #2: The Fox Customer Service team provides a customer specific Part Number for use on their Bill Of Materials (BOM).

Fox Part Number (The assigned Fox Part Number must be on the BOM – not the above Model Description)
(This will ensure receipt of the proper part)

The 1st Field
Product Code #
775 = FXTC-HE73

775 – 15.360 – 2

The 2nd Field
The Customer's Frequency

The 3rd Field
Fox Internally Generated Number
(If any specification changes, the last digits change)
(The same specs for a different customer also changes the last digits)

This example, **FXTC-HE73PR-15.360** = Temperature Compensated, HCMOS Output, Epoxy, 7 x 5mm Package, 3.3V, ±2.5 PPM Stability, -40 to +85°C Temperature Range, at 15.360 MHz



Absolute Maximum Ratings (Useful life may be impaired. For user guidelines only, not tested)

Parameters	Symbol	Condition	Maximum Value (unless otherwise noted)
Input Voltage	V_{DD}		-0.5V to +4.0V
Operating Temperature	T_{AMAX}		-55°C to +105°C
Storage Temperature	T_{STG}		-55°C to +125°C
Junction Temperature			125°C
ESD Sensitivity	HBM	Human Body Model	1 kV

Electrical Characteristics

Parameters	Symbol	Condition	Maximum Value (unless otherwise noted)
Frequency Range	F_o		0.75 to 250.000 MHz*
Initial Frequency Tolerance		$T_a=25^\circ\text{C}$ (after 2 reflows)	± 2 PPM
Frequency Stability over Temp (ref 25C)		0°C to +70°C -30°C to +80°C -40°C to +85°C	± 5 , 2.5, 1.5, 1 PPM ± 5 , 2.5, 1.5 PPM ± 5 , 2.5 PPM
Frequency Stability Over Voltage Change		($V_{DD} \pm 5\%$)	± 0.5 PPM
Frequency Stability Over Load Change		($CL \pm 10\%$)	± 0.2 PPM
Aging per Year			± 1 PPM
Temperature Range	T_o	Standard operating Extended option	0°C to +70°C -30°C to +80°C -40°C to +85°C
	T_{STG}	Storage	-55°C to +125°C
Supply Voltage	V_{DD}	Standard	3.3 V $\pm 5\%$
Input Current	I_{DD}	15pF Load - All frequencies	
		0.75 ~ 20 MHz	40 mA
		20+ ~ 50 MHz	43 mA
		50+ ~ 130 MHz	55 mA
		130+ ~ 200 MHz	63 mA
200+ ~ 250 MHz	68 mA		
Output Load	HCMOS	Standard	15 pF
		Optional To 125 MHz	30 pF
Start-Up Time	T_s		10 mS
Output Enable / Disable Time			100 nS

*Not all frequencies may be available.



Output Wave Characteristics			
Parameters	Symbol	Condition	Maximum Value (unless otherwise noted)
Output LOW Voltage	V_{OL}	15pF Load - All frequencies 0.75 to 150 MHz 150+ to 250 MHz	10% V_{DD} 20% V_{DD}
Output HIGH Voltage	V_{OH}	15pF Load - All frequencies 0.75 to 150 MHz 150+ to 250 MHz	90% V_{DD} MIN 80% V_{DD} MIN
Output Symmetry (See Drawing Below)		15pF Load - All frequencies @ 50% V_{DD} Level	45% ~ 55%
Output Enable (PIN # 2) Voltage	V_{IH}		$\geq 70\% V_{DD}$
Output Disable (PIN # 2) Voltage	V_{IL}		$\leq 30\% V_{DD}$
Cycle Rise Time (See Drawing Below)	T_R	15pF Load - All frequencies 0.75 to 150 MHz 150+ to 250 MHz	3 nS (10%-90%) 3 nS (20%-80%)
Cycle Fall Time (See Drawing Below)	T_F	15pF Load - All frequencies 0.75 to 150 MHz 150+ to 250 MHz	3 nS (90%-10%) 3 nS (80%-20%)

If 30% to 70% times are used, Rise and Fall times change to 1.5 nS from 0.75 to 250MHz
If 20% to 80% times are used, Rise and Fall times change to 2 nS from 0.75 to 150MHz

Rise Time / Fall Time Measurements

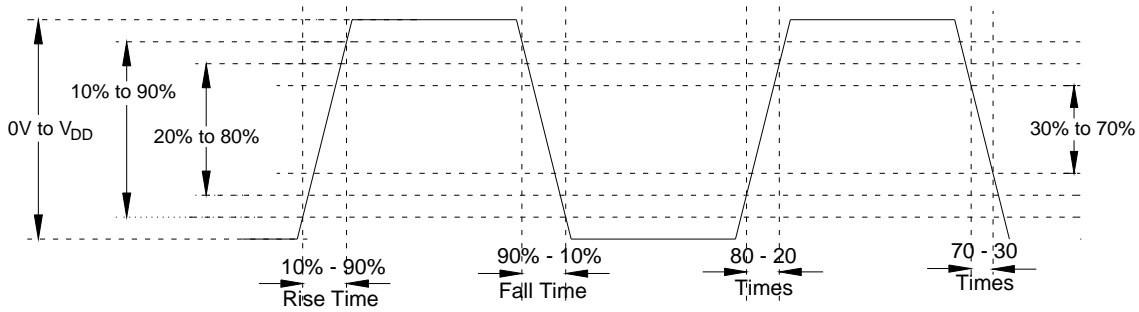

Oscillator Symmetry

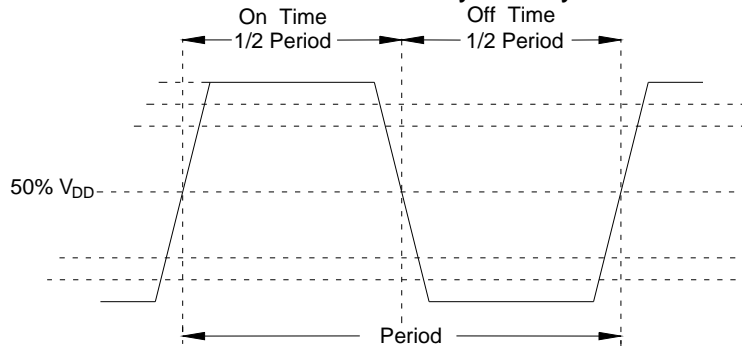

Ideally, Symmetry should be 50/50 -- Other expressions are 45/55 or 55/45

Phase Noise

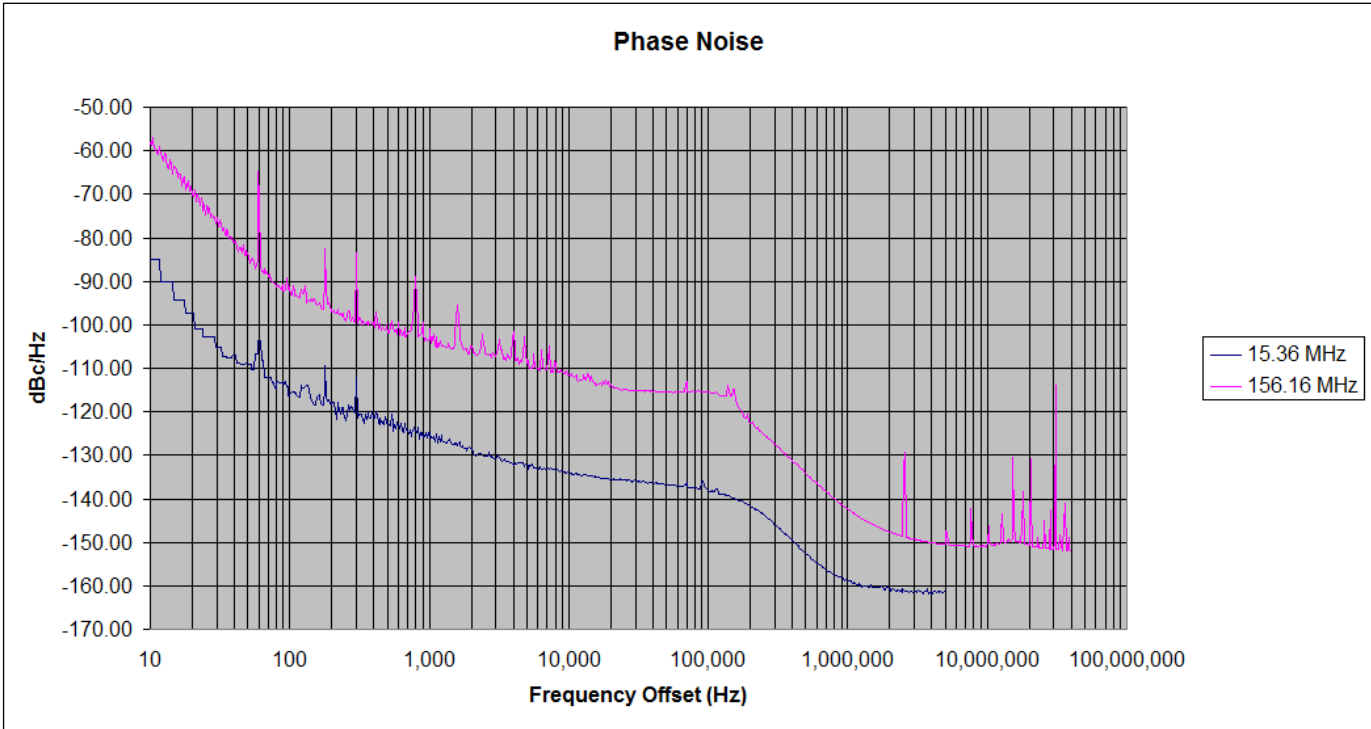

Phase Noise was measured on an Agilent 5052A Phase Noise Measurement System; measured directly into 50 ohm input; $V_{DD} = 3.3V$. 15.36MHz only to 5MHz offset due to Equipment Limitation.

Jitter is frequency dependent. Below are typical measured values at select frequencies.

Phase Jitter & Time Interval Error (TIE)

Frequency	Phase Jitter		TIE (Sigma of Jitter Distribution)	Units
	12kHz to 20MHz (Fo = 156.16 MHz)	12kHz to 5MHz (Fo = 15.36 MHz)		
15.36 MHz		0.94	3.5	pS RMS
156.16 MHz		1.10	3.9	pS RMS

Phase Jitter is integrated from Agilent 5052A Phase Noise Measurement System; measured directly into 50 ohm input; $V_{DD} = 3.3V$.

TIE was measured on LeCroy LC684 Digital Storage Scope, directly into 50 ohm input, with Amherst M1 software; $V_{DD} = 3.3V$.

Per **MJSQ spec** (Methodologies for Jitter and Signal Quality specifications)

Random & Deterministic Jitter Composition

Frequency	Random (Rj) (pS RMS)	Deterministic (Dj) (pS P-P)	Total Jitter (Tj) (14 x Rj) + Dj
15.36 MHz	1.68	8.7	32.7
156.16 MHz	1.47	10.3	31.3

Rj and Dj, measured on LeCroy LC684 Digital Storage Scope, directly into 50 ohm input, with Amherst M1 software.

Per **MJSQ spec** (Methodologies for Jitter and Signal Quality specifications)

Pin Description and Recommended Circuit

Pin #	Name	Type	Function
1	E / D ¹	Control	Enable / Disable Control of Output (0 = Disabled)
2	GND	Ground	Electrical Ground for V _{DD}
3	Output	Output	HCMOS Oscillator Output
4	V _{DD} ²	Power	Power Supply Source Voltage

NOTES:

- Includes pull-up resistor to V_{DD} to provide output when the pin (1) is No Connect.
- Installation should include a 0.01μF bypass capacitor placed between V_{DD} (Pin 4) and GND (Pin 2) to minimize power supply line noise.

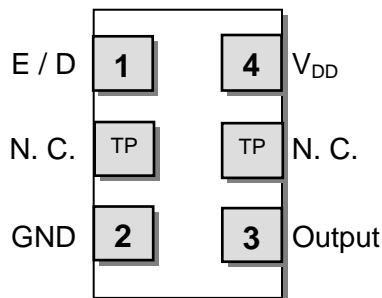

Terminations as viewed from the Top

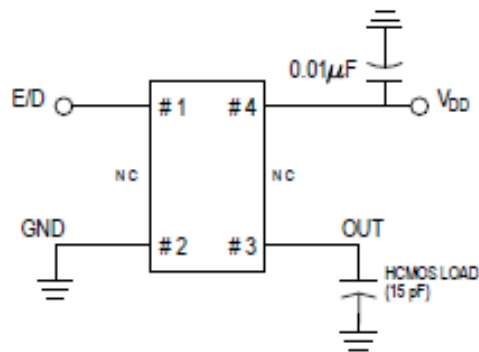

Enable / Disable Control

Pin # 1 (state)	Output (Pin # 3)
OPEN (No Connection)	ACTIVE Output
"1" Level $V_{IH} \geq 70\% V_{DD}$	ACTIVE Output
"0" Level $V_{IL} \leq 30\% V_{DD}$	High Impedance

Soldering Reflow Profile (2 times Maximum at 260°C for 10 seconds MAX)

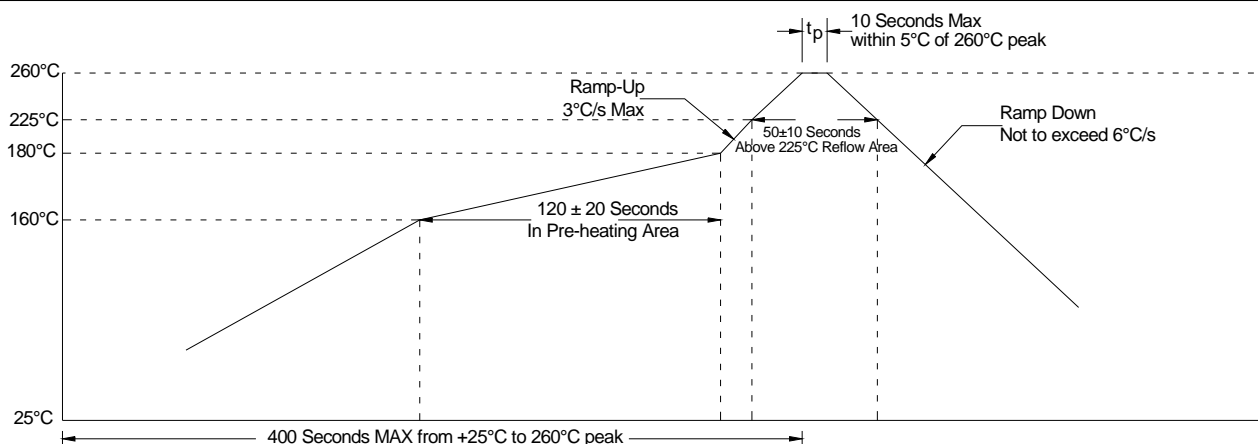

Mechanical Dimensional Drawing & Pad Layout

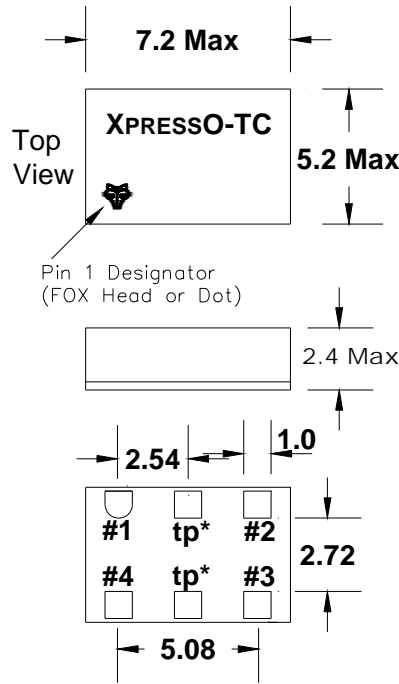

Actual part marking is depicted.

See Traceability (pg. 9) for more information

Recommended Solder Pad Layout

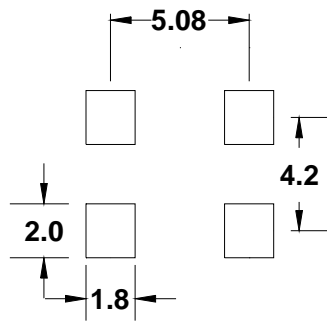

Note: XPRESSO HCMOS TCXOs are designed to fit on industry standard, 4 pad, layouts

Pin Connections

- #1) OE
- #2) GND
- #3) Output
- #4) VDD

* tp = test points and are no connect.

Drawing is for reference to critical specifications defined by size measurements. Certain non-critical visual attributes, such as side castellations, reference pin shape, etc. may vary

Tape and Reel Dimensions (mm)

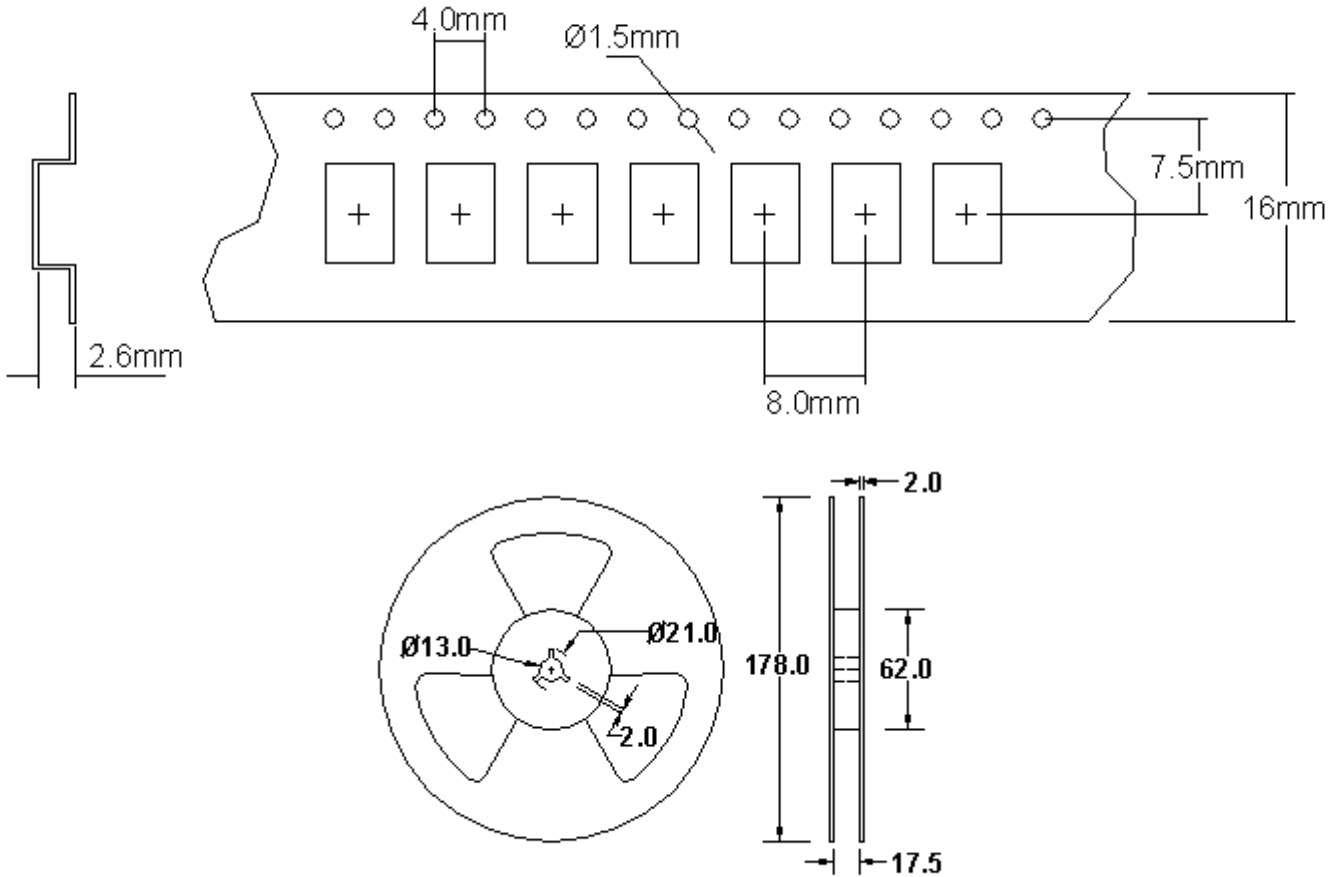

Std. reel qty. - 500 pcs.

Labeling (Reels and smaller packaging are labeled with the below) [Subject to Review]

- Fox Part Number: 775-15.36-2 →
- Quantity: 500 pieces →
- Description: **FXTC-HE73PR-15.360** →
- Date Code: **0745** →
(YYWW 2007 45th wk)
- LOT #: **24435** →

SKU **775-15.360-2**

QTY: 500

DESC **FXTC-HE73PR-15.360**

DATE CODE: 0745

LOT: 24435

Xpress0®

Covered by one or more of listed
U.S. Patents: 6,664,860, 5,960,403
5,960,405, 5,952,890, 6,188,290
Foreign Patents:
China ZL 98802217.6 Mexico 232
R.S.A. 98/0896, ROC 120851,
Singapore 67081; 67082,
EP 0958652 Hong Kong HK1026079
Malaysia MY-118540-A
Philippines Patent: 1-1998-000246
US and Foreign Patents Pending

Xpress0® is a Registered Trademark of Fox Electronics

**Pb-Free
RoHS Compliant
Category (e4)**



Traceability – LOT Number & Serial Identification

LOT Number

The LOT Number has direct ties to the customer purchase order. The LOT Number is marked on the “Reel” label, and also stored internally on non-volatile memory inside the XPRESSO-TC part. XPRESSO-TC parts that are shipped Tape and Reel, are also placed in an Electro Static Discharge (ESD) bag and will have the LOT Number labeled on the exterior of the ESD bag.

It is recommended that the XPRESSO-TC parts remain in this ESD bag during storage for protection and identification.

If the parts become separated from the label showing the LOT Number, it can be retrieved from inside one of the parts, and the information that can be obtained is listed below:

- Customer Purchase Order Number
- Internal Fox Sales Order Number
- Dates that the XPRESSO-TC part was shipped from the factory
- The assigned customer part number
- The specification that the part was designed for

Serial Identification

The Serial ID is the individualized information about the configuration of that particular XpressO-TC part. The Serial ID is unique for each and every XPRESSO-TC -TC part, and can be read by special Fox equipment.

With the Serial ID, the below information can be obtained about that individual, XPRESSO-TC part:

- Equipment that the XPRESSO-TC part was configured on
- Raw material used to configure the XPRESSO-TC part
- Traceability of the raw material back to the foundries manufacturing lot
- Date and Time that the part was configured
- Any optimized electrical parameters based on customer specifications
- Electrical testing of the actual completed part
- Human resource that was monitoring the configuration of the part

Fox has equipment placed at key Fox locations World Wide to read the Lot Identification and Serial Number of any XPRESSO-TC part produced and can then obtain the information from above within 24 hour

Environmental Testing

Parameter	Test Method
Mechanical Shock	MIL-STD-202, Method 213 Half sine wave (Figure 213-1) Test condition C (100g, 6mS)
Mechanical Vibration	MIL-STD-202, Method 204 Freq.range: 10~2000Hz Peak to peak amplitude:1.52mm. Peak acceleration:5G (49m/s ²) 3 direction(X, Y,Z),each 20min,Total 12cycles
High Temperature Burn-in	Under Power @ 125°C for 2000 Hours
Temperature Cycle	Power off -55°C ~ +125°C 15 minutes each temp 100 cycles
Humidity	MIL-STD-202, Method 103B, Test condition B. Power off Relative Humidity = 90 to 95%. Ta = 40C. Duration = 96 hours.



An Integrated Device Technology, Inc. Company

Model: FXTC-HE73 Series Preliminary

Notes:

Patent Numbers:

US 6,664,860, US 5,960,403, US 5,952,890; US 5,960,405; US 6,188,290; Foreign Patents: R.S.A. 98/0866, R.O.C. 120851; Singapore 67081, 67082; EP 0958652
China ZL 98802217.6, Malaysia MY-118540-A, Philippines 1-1998-000245, Hong Kong #HK1026079, Mexico #232179
US and Foreign Patents Pending
XpressO™ Fox Electronics

Contact Information

Email: www.foxonline.com/email.htm

(USA) Worldwide Headquarters

Tel: 888-GET-2-FOX
Outside US: +1.239.693.0099
Fax: +1.239.693.1554

Fox Asia

Tel: +852.2854.4285
Fax: +81.3.3377.5221

Fox Japan

Tel: +81.3.3374.2079
Fax: +81.3.3377.5221

Fox MEA

Tel: +44 1283 568153

Fox Canada

Tel: North America 239.464.2501
Outside US: +1.239.693.0099

All specifications subject to change without notice.

