



Product Overview

The LuxStrip II A006 is a powerful compact light engine built on a Printed Circuit Board (PCB) and thermally engineered to accommodate high brightness LEDs. Utilizing "driver on board" technology allows the entire unit to easily be integrated into fixtures where space is at a premium. The LuxStrip II is a perfect solution for applications such as general lighting, fluorescent replacement, sign, channel letters, and architectural lighting. As a standard offering at 12", the LuxStrip II comes with up to six CREE® XP-E or XP-G* devices. Strips can be cut to specific lengths, as short as 4". The strips are designed to interconnect to allow for varying lengths, and can be deployed in lengths up to 12 feet. Optics are available for directional lighting. Standard optical options are 5°, 8°, and 20°. Other options may be added to suit custom applications.

Unlike traditional PCBs, the driver for the LuxStrip II is conveniently contained on board, allowing power supplies which deliver a fixed voltage to be used. An industry standard 24VDC power supply is ideal for use with LuxStrip II. This is due to the use of a LUXdrive series power module, which allows for a fixed voltage input while maintaining a true, constant-current regulated output for the LEDs. Power and dimming control voltage is connected via a low profile board-to-board connector at the end of the strip, and utilizes a unique polarized connection for goof proof assembly. Several strips can be stacked/attached together upto 12 feet typical. "Stub" sections can be shortened at 2" increments to fit any length requirement.

* - Units can be customized for other LEDs or redesigned for OEM applications - Contact LUXdrive for more information

Features

- Designed to operate on 24VDC
- On board driver provides constant current
- 12" x .95", cuttable every 2", min length 4"
- Fits the Dialight 22mm optics (OPXP-1-xxxx)
- Easily joined for up to 12 feet length
- 0 to 100% dimming w/signal pass-through
- Works with 0-10V Dimmers, Lutron Nova T®
- Polarized connections - No Goofs
- Compatible with CREE® XP-E, and XP-G
- Series configuration eliminates current hogging

Typical Applications

- Line lighting and wall wash
- Automotive, RV & Marine Lighting
- Tight space and cove lighting
- Point of Purchase Lighting
- Desk & Reading Lamps
- Fluorescent replacement fixtures
- Cabinet & Display Case Lighting
- Sign & Channel Letters



Figure 1
(6) CREE XP-G LEDs in series
(VIN= 24VDC) and end-feeding another strip



Luminous Flux

Table 1
Typical Luminous Flux at LED Junction Temperature of 25°C

Type	Part Number	Color	Drive Current in (mA)	Luminous Flux	CRI	Continuous length (feet)	Power Consumption (per foot)
Cree XP-G	A006-GW750-35	5000K White	350	700 typ	75 typ	12 max	7W
	A006-GW750-70	5000K White	700	1270 typ	75 typ	8 max	15W
	A006-GW740-35	4000K White	350	700 typ	75 typ	12 max	7W
	A006-GW740-70	4000K White	700	1270 typ	75 typ	8 max	15W
	A006-GW830-35	3000K White	350	630 typ	80 typ	12 max	7W
	A006-GW830-70	3000K White	700	1080 typ	80 typ	8 max	15W
Cree XP-E	A006-EW750-35	5000K White	350	630 typ	75 typ	12 max	7W
	A006-EW750-70	5000K White	700	1080 typ	75 typ	8 max	15W
	A006-EW740-35	4000K White	350	630 typ	75 typ	12 max	7W
	A006-EW740-70	4000K White	700	1080 typ	75 typ	8 max	15W
	A006-EW830-35	3000K White	350	450 typ	80 typ	12 max	7W
	A006-EW830-70	3000K White	700	810 typ	80 typ	8 max	15W

Notes for Table 1:

1. Custom units available upon request, restrictions apply. Contact LUXdrive for additional details.
2. See CREE® XP-E, and XP-G data sheets for more details.

Part Number Identification

The part number is explained below:

A006- A B C DD - EE

Where:

A006 designates the LUXdrive Product ID for a LuxStrip II board

A designates LED Type (G for XP-G, E for XP-E, C for XP-C)

B designates LED color (W= White)

C designates CRI value (7= 75typ, 8=80 typ, 0 for direct color variants)

DD designates Color Variant (30=3000K White, 40=4000K White, 50=5000K White)

EE designates Drive Current (35=350mA, 70=700mA)

Thermal Resistance (LED junctions to bottom of PCB)

LuxStrip II with XP-G LEDs in white 2.5° C/W

Operating Temperature (T_{opr})..... -40° to 100°C³

LED junction temperature must be kept within manufacturers limits. See CREE® XP-E, XP-G data sheets for more details

³FR4 board temperature

Heat Sinking and Mounting

The LuxStrip II has five mounting points for #4, or #6 screws used with fiber or nylon washers. These screw holes are provided to allow secure connection to the heat sink. Thermal epoxy, or double-sided thermal tape may be used for speedy and easy assembly. The LuxStrip II should be attached to additional heat sink for proper thermal management. At minimum, a heat sink of a metal plate (copper or aluminum), attached using a thermal interface material (such as LUXdrive A006-TAT), should be used to increase the area exposed to free air. The LuxStrip II FR4 Printed Circuit Board has a backing plate that is electrically isolated from the emitter. It is not necessary to use an electrically insulating thermal interface material.

Table 2

Part Number	Description	Number of Feet	Compatible With
A006-TAT	Thermal Adhesive	180	A006

Connection Diagram

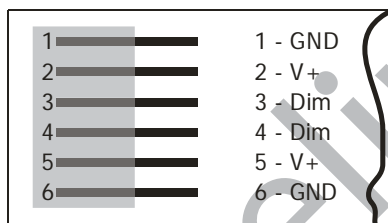

Figure 2
LuxStrip II wiring diagram

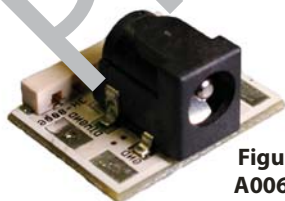

Figure 3
A006-PN

There are two different types of wiring connectors available for the LuxStrip II. Both connectors are 24.1mm (0.95") wide and 19.1mm (0.75") long. The A006-HE which has four wires, two wires for power in and two wires for dimming, and the A006-HN which has 2 wires for power in. Also available are the Barrel Plug connectors A006-PE and A006-PN. Both Barrel Plug connectors feature a 2.5mm center positive plug. The A006-PE has dimming wires while the A006-PN does not. Both Barrel Plug solutions offer solderless setup of the system.

Custom connectors available upon request, restrictions apply. Contact LUXdrive for additional details.

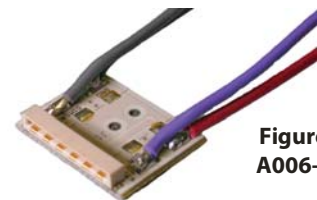
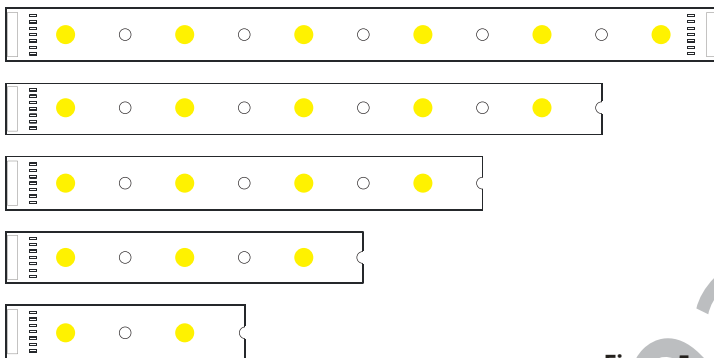

Figure 4
A006-HE

Configuration

To be able to fit lengths of less than 12", the LuxStrip II can be trimmed as necessary. This method is called "stub", where the unpowered end of the strip is cut to fit the fixture or extrusion. A common hacksaw and soldering iron is all that is required to allow for field modification of the strips to accommodate custom installations. Jumper pads are available at each cut point to shorten the electrical length of each string. Simply jump the pad that is located before the cut. The remaining LEDs will get the proper current and voltage since they have their own driver. As the length of the LuxStrip II is reduced, the minimum voltage to power the unit is also reduced. Using this approach, here are the possible lengths:



Length	Number of LEDs
305mm (12")	6
254mm (10")	5
203mm (8")	4
152mm (6")	3
102mm (4")	2

Figure 5
Typical "stub" strip cut lengths and results

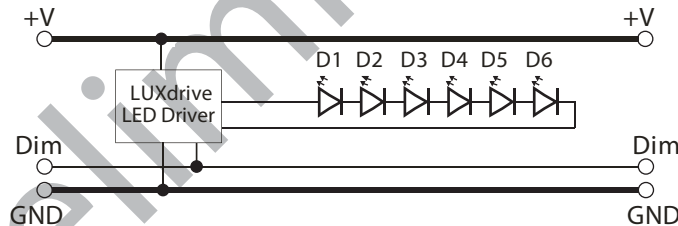

Figure 6
Electrical equivalent of LuxStrip II

Optics

The LuxStrip II can be fitted with many different optics from the major optics manufacturers. Dialight optics, also offered by LUXdrive, offer five different illumination patterns: spot (5°), frosted spot (7°), medium (8°), wide (20°), and oval (8° x 25°) (Note that LED type and color will have a slight effect on illumination pattern, e.g., non-white LEDs give a narrower distribution). See the Dialight CREETM XP[®] ADHESIVE-BACKED LENS SYSTEM" data sheet for more information, including typical light distribution patterns.

Table 3

TYPE	Part Number	Description	Number of LEDs	Half Width Viewing Angle	Compatible With
LuxStrip II	L2-OPXP-1-SPOT	Spot Base Module	1	5°	A006
	L2-OPXP-1-SDIF	Frosted Spot Base Module	1	7°	A006
	L2-OPXP-1-MED	Medium Base Module	1	8°	A006
	L2-OPXP-1-WIDE	Wide Frosted Base Module	1	20°	A006
	L2-OPXP-1-OVAL	Oval Base Module	1	8° x 25°	A006

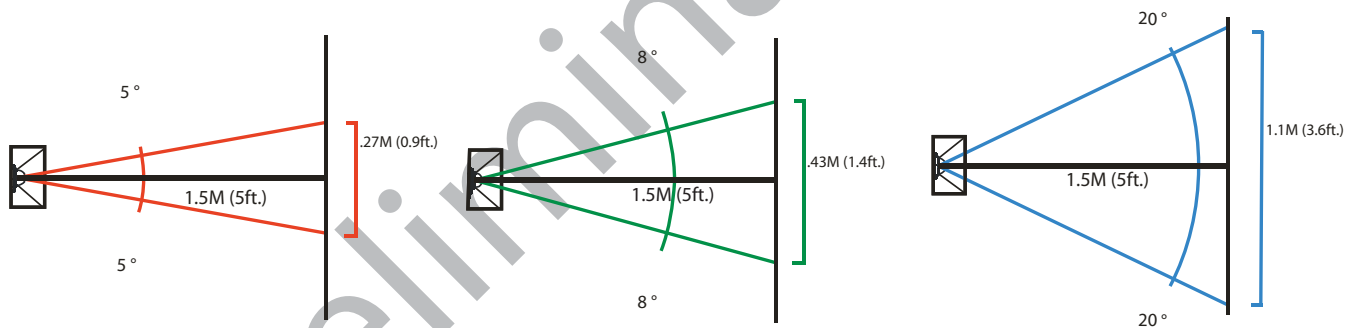

Figure 7
standard illumination patterns available,
and approximate diffusion at 1.5M (5ft.)



Figure 8
LuxStrip II with optics.

Physical Dimensions

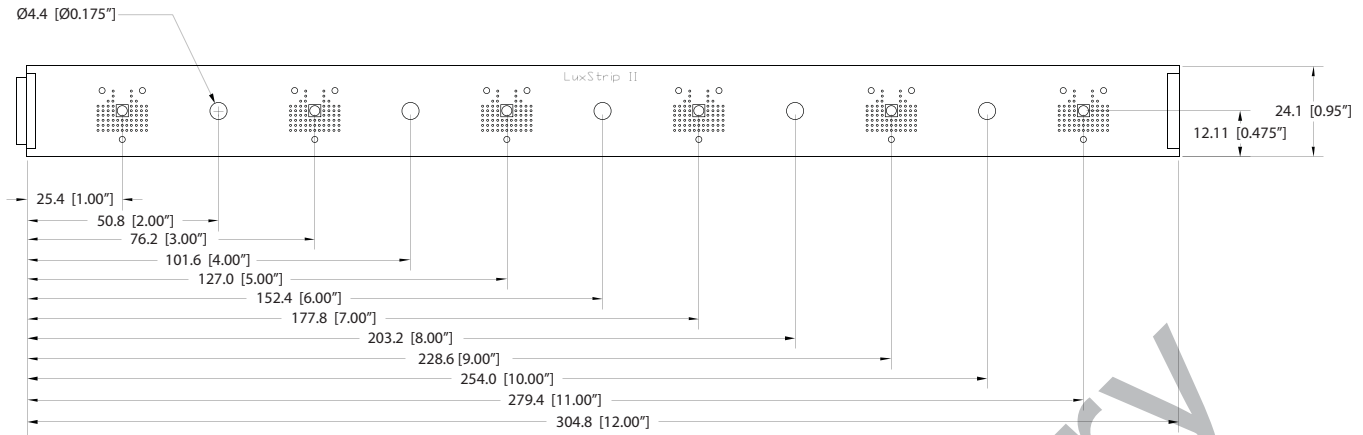

Figure 9a
Top View - Typical Physical Dimensions,
Including Mounting Holes

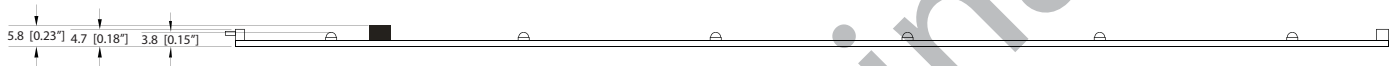

Figure 9b
Side View - Typical Height

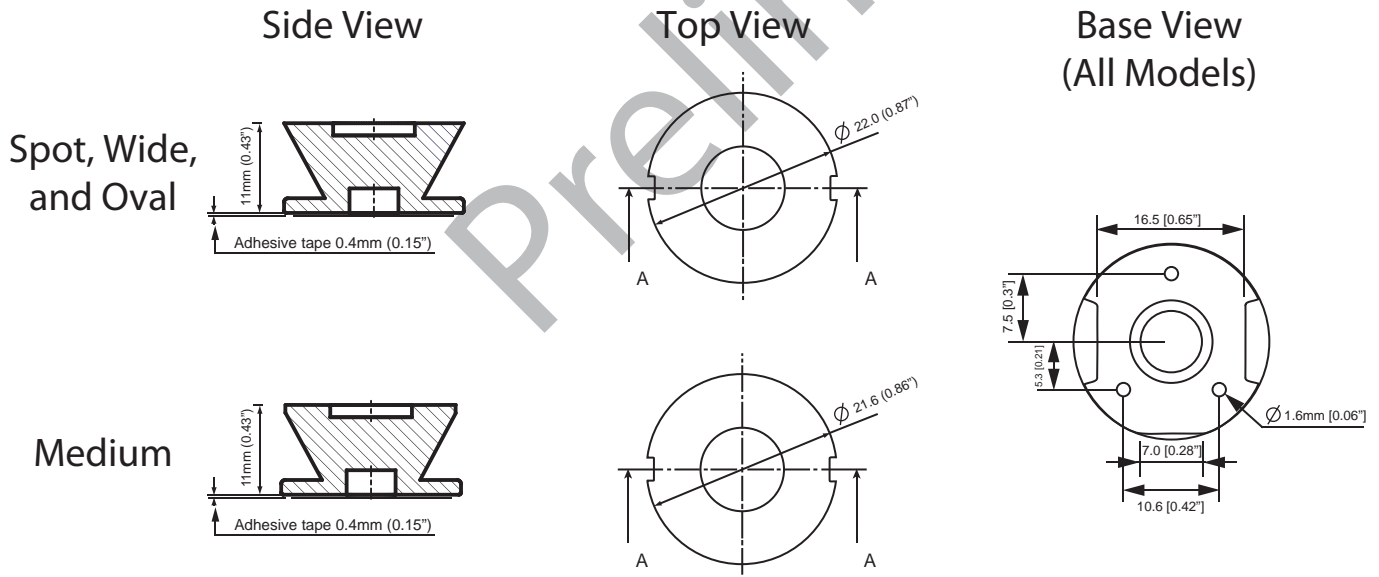

Figure 10
Typical Dimensions for the Dialight Optic.