

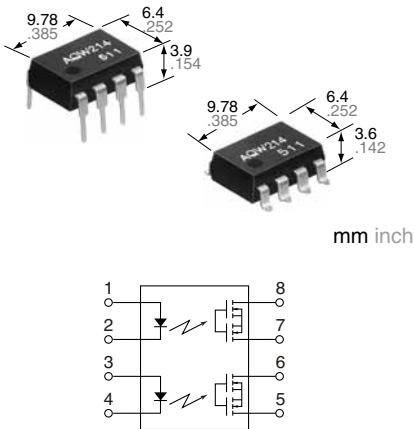

Compact DIP8-pin type of 60V to 600V load voltage

**PhotoMOS®
GU 2 Form A
(AQW21○)**



mm inch

RoHS compliant

FEATURES

- 1. Compact 8-pin DIP size**
The device comes in a compact (W) 6.4 × (L) 9.78 × (H) 3.9 mm (W) .252 × (L) .385 × (H) .154 inch, 8-pin DIP size (through hole terminal type).
- 2. Applicable for 2 Form A use as well as two independent 1 Form A use**
- 3. Controls low-level analog signals**
PhotoMOS feature extremely low closed-circuit offset voltage to enable control of low-level analog signals without distortion.
- 4. High sensitivity and high speed response**
Can control max. 0.6 A load current with 5 mA input current. Fast operation speed of typ. 0.65 ms (AQW212).

- 5. Low-level off state leakage current of max. 1 μA**
- 6. Wide variation of load voltage 60V to 600V**

TYPICAL APPLICATIONS

- High-speed inspection machines
- Telephones equipment
- Computer

TYPES

	Output rating*		Package	Part No.				Packing quantity	
				Through hole terminal	Surface-mount terminal			Tube	Tape and reel
	Load voltage	Load current		Tube packing style		Tape and reel packing style			
AC/DC dual use	60V	500 mA	DIP8-pin	AQW212	AQW212A	AQW212AX	AQW212AZ	1 tube contains: 50 pcs. 1 batch contains: 500 pcs.	1,000 pcs.
	100 V	300 mA		AQW215	AQW215A	AQW215AX	AQW215AZ		
	200 V	160 mA		AQW217	AQW217A	AQW217AX	AQW217AZ		
	350 V	120 mA		AQW210	AQW210A	AQW210AX	AQW210AZ		
	400 V	100 mA		AQW214	AQW214A	AQW214AX	AQW214AZ		
	600 V	40 mA		AQW216	AQW216A	AQW216AX	AQW216AZ		

*Indicate the peak AC and DC values.

Note: The surface mount terminal shape indicator "A" and the packing style indicator "X" or "Z" are not marked on the device.

RATING

1. Absolute maximum ratings (Ambient temperature: 25°C 77°F)

Item		Symbol	AQW212(A)	AQW215(A)	AQW217(A)	AQW210(A)	AQW214(A)	AQW216(A)	Remarks	
Input	LED forward current	I _F	50 mA							
	LED reverse voltage	V _R	5 V							
	Peak forward current	I _{FP}	1 A							f = 100 Hz, Duty factor = 0.1%
	Power dissipation	P _{in}	75 mW							
Output	Load voltage (peak AC)	V _L	60 V	100 V	200 V	350 V	400 V	600 V		
	Continuous load current	I _L	0.50 A (0.60A)	0.30 A (0.35 A)	0.16 A (0.2 A)	0.12 A (0.14 A)	0.10 A (0.13 A)	0.04 A (0.05 A)	Peak AC, DC (): in case of using only 1 channel	
	Peak load current	I _{peak}	1.5 A	0.9 A	0.48 A	0.36 A	0.3 A	0.12 A	A connection: 100 ms (1 shot), V _L = DC	
	Power dissipation	P _{out}	800 mW							
Total power dissipation		P _T	850 mW							
I/O isolation voltage		V _{iso}	1,500 V AC							Between input and output/between contact sets
Temperature limits	Operating	T _{opr}	-40°C to +85°C -40°F to +185°F							Non-condensing at low temperatures
	Storage	T _{stg}	-40°C to +100°C -40°F to +212°F							

GU 2 Form A (AQW210)

2. Electrical characteristics (Ambient temperature: 25°C 77°F)

Item		Symbol	AQW212(A)	AQW215(A)	AQW217(A)	AQW210(A)	AQW214(A)	AQW216(A)	Condition
Input	LED operate current	Typical	0.9 mA						I _L = Max.
		Maximum	3 mA						
	LED turn off current	Minimum	0.4 mA						I _L = Max.
		Typical	0.8 mA						
LED dropout voltage	Typical	1.25 V (1.14 V at I _F = 5 mA)						I _F = 50 mA	
	Maximum	1.5 V							
Output	On resistance	Typical	0.83 Ω	2.3 Ω	11 Ω	23 Ω	30 Ω	70 Ω	I _F = 5 mA I _L = Max. Within 1 s on time
		Maximum	2.5 Ω	4.0 Ω	15 Ω	35 Ω	50 Ω	120 Ω	
	Off state leakage current	Maximum	1 μA						
Transfer characteristics	Turn on time*	Typical	0.65 ms	0.60 ms	0.25 ms	0.25 ms	0.31 ms	0.28 ms	I _F = 5 mA I _L = Max.
		Maximum	2 ms	2 ms	1.0 ms	0.5 ms	0.5 ms	0.5 ms	
	Turn off time*	Typical	0.08 ms	0.06 ms	0.05 ms	0.05 ms	0.05 ms	0.04 ms	I _F = 5 mA I _L = Max.
		Maximum	0.2 ms						
	I/O capacitance	Typical	0.8 pF						f = 1 MHz V _S = 0 V
		Maximum	1.5 pF						
Initial I/C isolation resistance	Minimum	1,000 MΩ						500 V DC	

*Turn on/Turn off time

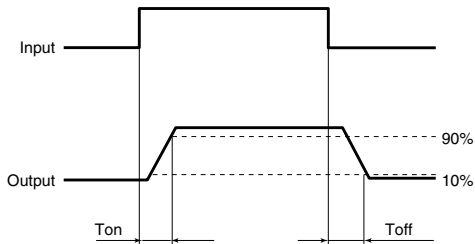

RECOMMENDED OPERATING CONDITIONS

Please obey the following conditions to ensure proper device operation and resetting.

Item	Symbol	Recommended value	Unit
Input LED current	I _F	5	mA

■ These products are not designed for automotive use.

If you are considering to use these products for automotive applications, please contact your local Panasonic Corporation technical representative.

REFERENCE DATA

1. Load current vs. ambient temperature characteristics

Allowable ambient temperature: -40°C to +85°C
-40°F to +185°F

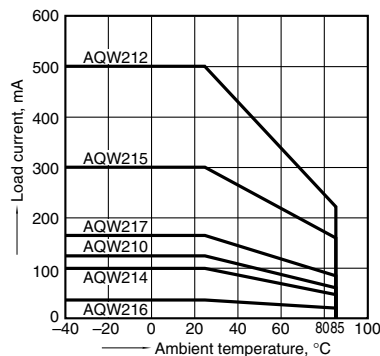

2.-(1) On resistance vs. ambient temperature characteristics

Measured portion: between terminals 5 and 6, 7 and 8;
LED current: 5 mA; Load voltage: Max. (DC);
Continuous load current: Max. (DC)

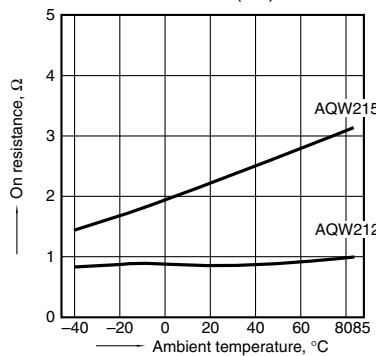

2.-(2) On resistance vs. ambient temperature characteristics

Measured portion: between terminals 5 and 6, 7 and 8;
LED current: 5 mA; Load voltage: Max. (DC);
Continuous load current: Max. (DC)

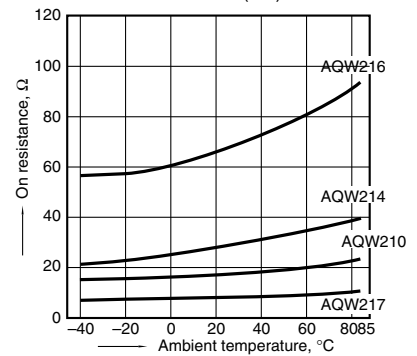

3. Turn on time vs. ambient temperature characteristics

LED current: 5 mA; Load voltage: Max. (DC); Continuous load current: Max. (DC)

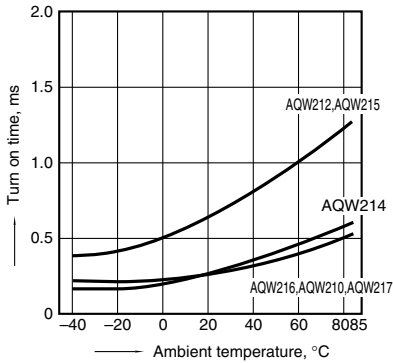

4. Turn off time vs. ambient temperature characteristics

LED current: 5 mA; Load voltage: Max. (DC); Continuous load current: Max. (DC)

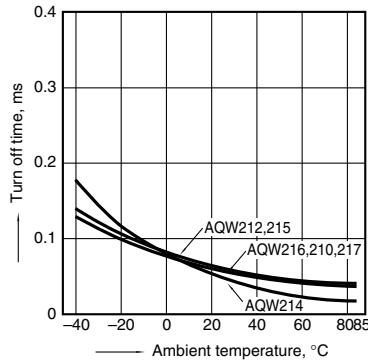

5. LED operate current vs. ambient temperature characteristics

Sample: All types; Load voltage: Max. (DC); Continuous load current: Max. (DC)

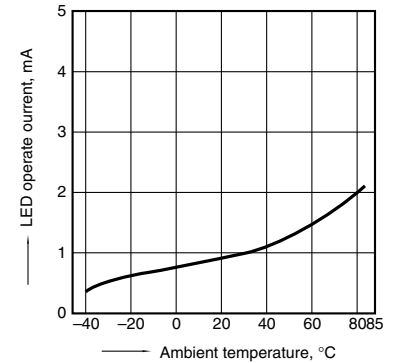

6. LED turn off current vs. ambient temperature characteristics

Sample: All types; Load voltage: Max. (DC); Continuous load current: Max. (DC)

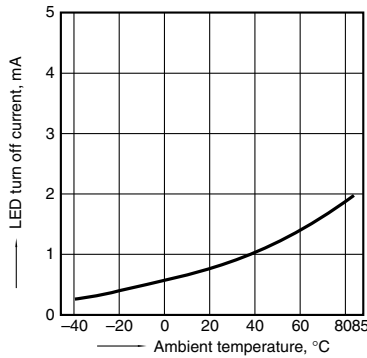

7. LED dropout voltage vs. ambient temperature characteristics

Sample: All types; LED current: 5 to 50 mA

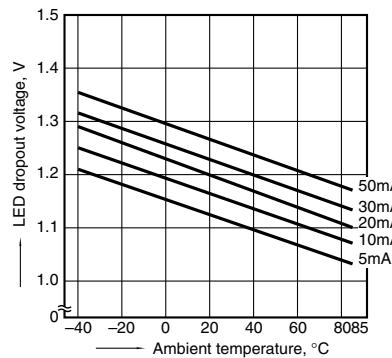

8.-(1) Current vs. voltage characteristics of output at MOS portion

Measured portion: between terminals 5 and 6, 7 and 8; Ambient temperature: 25°C 77°F

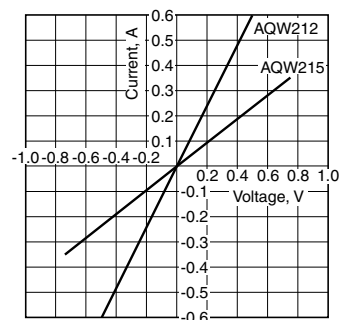

8.-(2) Current vs. voltage characteristics of output at MOS portion

Measured portion: between terminals 5 and 6, 7 and 8; Ambient temperature: 25°C 77°F

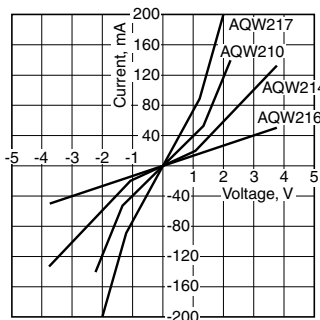

9.-(1) Off state leakage current vs. load voltage characteristics

Measured portion: between terminals 5 and 6, 7 and 8; Ambient temperature: 25°C 77°F

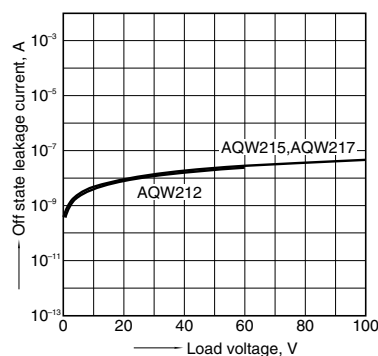

9.-(2) Off state leakage current vs. load voltage characteristics

Measured portion: between terminals 5 and 6, 7 and 8; Ambient temperature: 25°C 77°F

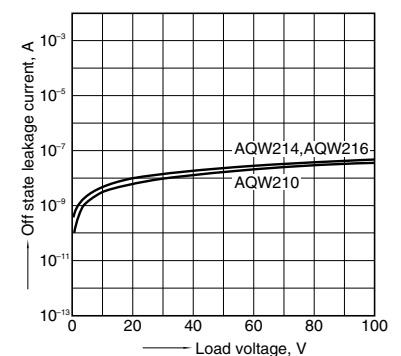

10. Turn on time vs. LED forward current characteristics

Measured portion: between terminals 5 and 6, 7 and 8; Load voltage: Max. (DC); Continuous load current: Max. (DC); Ambient temperature: 25°C 77°F

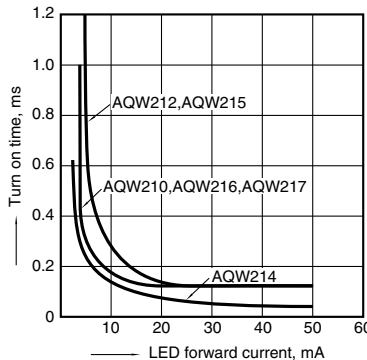

11. Turn off time vs. LED forward current characteristics

Measured portion: between terminals 5 and 6, 7 and 8; Load voltage: Max. (DC); Continuous load current: Max. (DC); Ambient temperature: 25°C 77°F

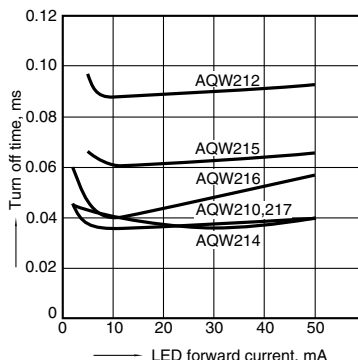

12. Output capacitance vs. applied voltage characteristics

Measured portion: between terminals 5 and 6, 7 and 8; Frequency: 1 MHz; Ambient temperature: 25°C 77°F

