

## MAX12930/MAX12931

## Two-Channel Digital Isolators

### General Description

The MAX12930/MAX12931 are a family of 2-channel, 3.75kV/5kVRMS digital galvanic isolators using Maxim's proprietary process technology. These devices transfer digital signals between circuits with different power domains while using as little as 0.65mW per channel at 1Mbps with 1.8V.

The two channels of the MAX12931 transfer data in opposite directions, and this makes the MAX12931 ideal for isolating the TX and RX lines of a transceiver. The MAX12930 features two channels transferring data in the same direction.

Both devices are available with a maximum data rate of either 25Mbps or 150Mbps and with the default outputs that are either high or low. The default is the state the output assumes when the input is not powered, or if the input is open-circuit. See the [Ordering Information](#) for suffixes associated with each option. Independent 1.71V to 5.5V supplies on each side of the isolator also make the devices suitable for use as level translators.

The MAX12930/MAX12931 are available in an 8-pin, narrow-body SOIC package. In addition, the MAX12931 is available in a 16-pin, wide-body SOIC package. The package material has a minimum comparative tracking index (CTI) of 600V, which gives it a group 1 rating in creepage tables. All devices are rated for operation at ambient temperatures of -40°C to +125°C.

### Benefits and Features

- Robust Galvanic Isolation of Digital Signals
  - Withstands 5kV<sub>RMS</sub> for 60s (VISO) Wide-Body
  - Withstands 3.75kV<sub>RMS</sub> for 60s (VISO) Narrow-Body
  - Continuously Withstands 848V<sub>RMS</sub> (VIOWM) Wide-Body
  - Continuously Withstands 445V<sub>RMS</sub> (VIOWM) Narrow-Body
  - Withstands ±10kV Surge between GNDA and GNDB with 1.2/50µs waveform
  - High CMTI (50kV/µs, typ)
- Options to Support a Broad Range of Applications
  - 2 Data Rates (25Mbps/150Mbps)
  - 2 Channel Direction Configurations
  - 2 Output Default States (High or Low)
- Low Power Consumption
  - 1.3mW per Channel at 1Mbps with V<sub>DD</sub> = 3.3V
  - 3.3mW per Channel at 100Mbps with V<sub>DD</sub> = 1.8V

### Applications

- Fieldbus Communications for Industrial Automation
- Isolated RS232, RS-485/RS-422, CAN
- General Isolation Application
- Battery Management
- Medical Systems

### Functional Diagrams

[Ordering Information](#) appears at end of data sheet.

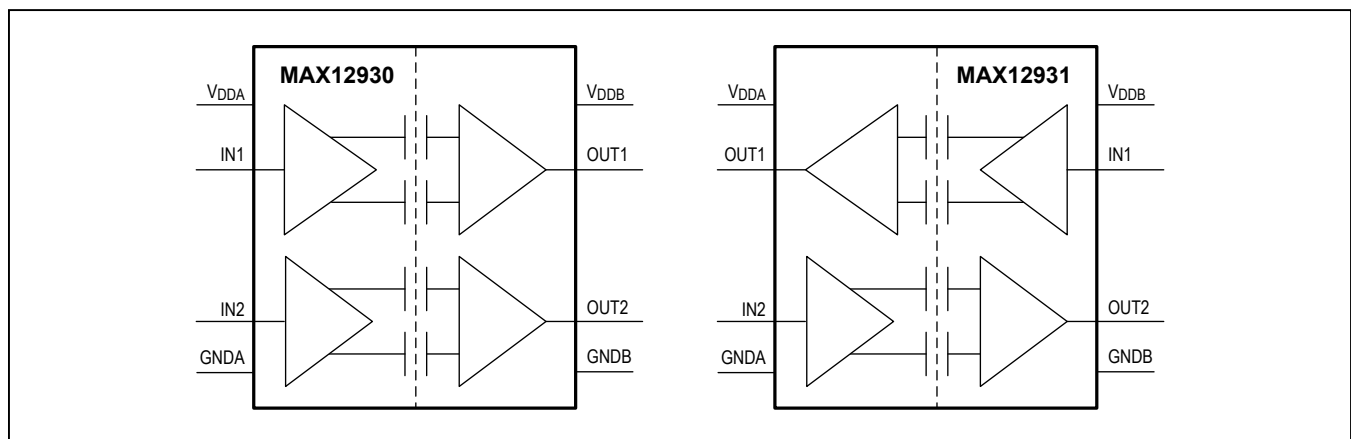

**Absolute Maximum Ratings**

V <sub>DDA</sub> to GNDA.....	-0.3V to +6V	Continuous Power Dissipation (T <sub>A</sub> = +70°C) Wide SOIC (derate 14.1mW/°C above +70°C) ..... 1126.8mW Narrow SOIC (derate 13.3mW/°C above +70°C).....588.2mW Operating Temperature Range..... -40°C to +125°C Maximum Junction Temperature ..... +150°C Storage Temperature Range ..... -60°C to +150°C Soldering Temperature (reflow) ..... +260°C
V <sub>DDB</sub> to GNDB.....	-0.3V to +6V	
IN_ on SIDE A to GNDA.....	-0.3V to +6V	
IN_ on SIDE B to GNDB.....	-0.3V to +6V	
OUT_ on SIDE A to GNDA.....	-0.3V to V <sub>DDA</sub> + 0.3V	
OUT_ on SIDE B to GNDB.....	-0.3V to V <sub>DDB</sub> + 0.3V	
Short-Circuit Duration		
OUT_ on SIDE A to GNDA, OUT_ on SIDE B to GNDB		
.....	Continuous	

Stresses beyond those listed under "Absolute Maximum Ratings" may cause permanent damage to the device. These are stress ratings only, and functional operation of the device at these or any other conditions beyond those indicated in the operational sections of the specifications is not implied. Exposure to absolute maximum rating conditions for extended periods may affect device reliability.

**Package Thermal Characteristics (Note 1)**

Wide SOIC		Narrow SOIC	
Junction-to-Ambient Thermal Resistance (θ <sub>JA</sub> ) .....	71°C/W	Junction-to-Ambient Thermal Resistance (θ <sub>JA</sub> ) .....	136°C/W
Junction-to-Case Thermal Resistance (θ <sub>JC</sub> ).....	23°C/W	Junction-to-Case Thermal Resistance (θ <sub>JC</sub> ).....	38°C/W

**Note 1:** Package thermal resistances were obtained using the method described in JEDEC specification JESD51-7, using a four-layer board. For detailed information on package thermal considerations, refer to [www.maximintegrated.com/thermal-tutorial](http://www.maximintegrated.com/thermal-tutorial).

**DC Electrical Characteristics**

(V<sub>DDA</sub> - V<sub>GNDA</sub> = 1.71V to 5.5V, V<sub>DDB</sub> - V<sub>GNDB</sub> = 1.71V to 5.5V, C<sub>L</sub> = 15pF, T<sub>A</sub> = -40°C to +125°C, unless otherwise noted. Typical values are at V<sub>DDA</sub> - V<sub>GNDA</sub> = 3.3V, V<sub>DDB</sub> - V<sub>GNDB</sub> = 3.3V, GNDA = GNDB, T<sub>A</sub> = 25°C, unless otherwise noted.) (Note 2)

PARAMETER	SYMBOL	CONDITIONS	MIN	TYP	MAX	UNITS
<b>POWER SUPPLY</b>						
Supply Voltage	V <sub>DDA</sub>	Relative to GNDA	1.71		5.5	V
	V <sub>DDB</sub>	Relative to GNDB	1.71		5.5	
Undervoltage-Lockout Threshold	V <sub>UVLO_</sub>	V <sub>DD_</sub> rising	1.5	1.6	1.66	V
Undervoltage-Lockout Threshold Hysteresis	V <sub>UVLO_HYST</sub>			45		mV

**DC Electrical Characteristics (continued)**

( $V_{DDA} - V_{GNDA} = 1.71V$  to  $5.5V$ ,  $V_{DDB} - V_{GNDB} = 1.71V$  to  $5.5V$ ,  $C_L = 15pF$ ,  $T_A = -40^{\circ}C$  to  $+125^{\circ}C$ , unless otherwise noted. Typical values are at  $V_{DDA} - V_{GNDA} = 3.3V$ ,  $V_{DDB} - V_{GNDB} = 3.3V$ ,  $GNDA = GNDB$ ,  $T_A = 25^{\circ}C$ , unless otherwise noted.) (Note 2)

PARAMETER	SYMBOL	CONDITIONS	MIN	TYP	MAX	UNITS
Supply Current (MAX12930_) (Note 3)	I <sub>DDA</sub>	1MHz square wave, C <sub>L</sub> = 0pF	V <sub>DDA</sub> = 5V	0.32	0.58	mA
			V <sub>DDA</sub> = 3.3V	0.31	0.54	
			V <sub>DDA</sub> = 2.5V	0.3	0.53	
			V <sub>DDA</sub> = 1.8V	0.29	0.39	
		12.5MHz square wave, C <sub>L</sub> = 0pF	V <sub>DDA</sub> = 5V	0.81	1.26	
			V <sub>DDA</sub> = 3.3V	0.8	1.20	
			V <sub>DDA</sub> = 2.5V	0.78	1.18	
			V <sub>DDA</sub> = 1.8V	0.77	1.01	
		50MHz square wave, C <sub>L</sub> = 0pF	V <sub>DDA</sub> = 5V	2.15	3.00	
			V <sub>DDA</sub> = 3.3V	2.09	2.91	
			V <sub>DDA</sub> = 2.5V	2.06	2.88	
			V <sub>DDA</sub> = 1.8V	2	2.62	
	I <sub>DDB</sub>	1MHz square wave, C <sub>L</sub> = 0pF	V <sub>DDB</sub> = 5V	0.5	0.83	mA
			V <sub>DDB</sub> = 3.3V	0.47	0.79	
			V <sub>DDB</sub> = 2.5V	0.45	0.76	
			V <sub>DDB</sub> = 1.8V	0.4	0.67	
		12.5MHz square wave, C <sub>L</sub> = 0pF	V <sub>DDB</sub> = 5V	1.37	1.83	
			V <sub>DDB</sub> = 3.3V	1.02	1.40	
			V <sub>DDB</sub> = 2.5V	0.87	1.22	
			V <sub>DDB</sub> = 1.8V	0.71	1.00	
		50MHz square wave, C <sub>L</sub> = 0pF	V <sub>DDB</sub> = 5V	4.21	4.99	
			V <sub>DDB</sub> = 3.3V	2.81	3.39	
			V <sub>DDB</sub> = 2.5V	2.21	2.69	
			V <sub>DDB</sub> = 1.8V	1.69	2.04	

**DC Electrical Characteristics (continued)**

( $V_{DDA} - V_{GNDA} = 1.71V$  to  $5.5V$ ,  $V_{DDB} - V_{GNDB} = 1.71V$  to  $5.5V$ ,  $C_L = 15pF$ ,  $T_A = -40^{\circ}C$  to  $+125^{\circ}C$ , unless otherwise noted. Typical values are at  $V_{DDA} - V_{GNDA} = 3.3V$ ,  $V_{DDB} - V_{GNDB} = 3.3V$ ,  $GNDA = GNDB$ ,  $T_A = 25^{\circ}C$ , unless otherwise noted.) (Note 2)

PARAMETER	SYMBOL	CONDITIONS	MIN	TYP	MAX	UNITS	
Supply Current (MAX12931_) (Note 3)	$I_{DDA}$	1MHz square wave, $C_L = 0pF$	$V_{DDA} = 5V$	0.42	0.70	mA	
			$V_{DDA} = 3.3V$	0.39	0.67		
			$V_{DDA} = 2.5V$	0.38	0.64		
			$V_{DDA} = 1.8V$	0.36	0.56		
		12.5MHz square wave, $C_L = 0pF$	$V_{DDA} = 5V$	1.07	1.52		
			$V_{DDA} = 3.3V$	0.89	1.29		
			$V_{DDA} = 2.5V$	0.81	1.19		
			$V_{DDA} = 1.8V$	0.73	1.03		
		50MHz square wave, $C_L = 0pF$	$V_{DDA} = 5V$	3.06	3.87		
			$V_{DDA} = 3.3V$	2.37	3.06		
			$V_{DDA} = 2.5V$	2.08	2.72		
			$V_{DDA} = 1.8V$	1.82	2.33		
	$I_{DDB}$	1MHz square wave, $C_L = 0pF$	$V_{DDB} = 5V$	0.42	0.70		mA
			$V_{DDB} = 3.3V$	0.39	0.67		
			$V_{DDB} = 2.5V$	0.38	0.64		
			$V_{DDB} = 1.8V$	0.36	0.56		
		12.5MHz square wave, $C_L = 0pF$	$V_{DDB} = 5V$	1.07	1.52		
			$V_{DDB} = 3.3V$	0.89	1.29		
			$V_{DDB} = 2.5V$	0.81	1.19		
			$V_{DDB} = 1.8V$	0.73	1.03		
		50MHz square wave, $C_L = 0pF$	$V_{DDB} = 5V$	3.06	3.87		
			$V_{DDB} = 3.3V$	2.37	3.06		
			$V_{DDB} = 2.5V$	2.08	2.72		
			$V_{DDB} = 1.8V$	1.82	2.33		
<b>LOGIC INPUTS AND OUTPUTS</b>							
Input High Voltage	$V_{IH}$	$2.25V \leq V_{DD\_} \leq 5.5V$	$0.7 \times V_{DD\_}$			V	
		$1.71V \leq V_{DD\_} < 2.25V$	$0.75 \times V_{DD\_}$				
Input Low Voltage	$V_{IL}$	$2.25V \leq V_{DD\_} \leq 5.5V$	0.8			V	
		$1.71V \leq V_{DD\_} < 2.25V$	0.7				
Input Hysteresis	$V_{HYS}$	MAX1293_B/E	410			mV	
		MAX1293_C/F	80				
Input Pullup Current (Note 4)	$I_{PU}$	IN_, MAX1293_B/C	-10	-5	-1.5	$\mu A$	
Input Pulldown Current (Note 4)	$I_{PD}$	IN_, MAX1293_E/F	1.5	5	10	$\mu A$	
Input Capacitance	$C_{IN}$	IN_, $f_{SW} = 1MHz$	2			pF	

### DC Electrical Characteristics (continued)

( $V_{DDA} - V_{GNDA} = 1.71V$  to  $5.5V$ ,  $V_{DDB} - V_{GNDB} = 1.71V$  to  $5.5V$ ,  $C_L = 15pF$ ,  $T_A = -40^\circ C$  to  $+125^\circ C$ , unless otherwise noted. Typical values are at  $V_{DDA} - V_{GNDA} = 3.3V$ ,  $V_{DDB} - V_{GNDB} = 3.3V$ ,  $GNDA = GNDB$ ,  $T_A = 25^\circ C$ , unless otherwise noted.) (Note 2)

PARAMETER	SYMBOL	CONDITIONS	MIN	TYP	MAX	UNITS
Output Voltage High (Note 4)	$V_{OH}$	$I_{OUT} = 4mA$ source	$V_{DD\_} - 0.4$			V
Output Voltage Low (Note 4)	$V_{OL}$	$I_{OUT} = 4mA$ sink			0.4	V

### Dynamic Characteristics MAX1293\_B/E

( $V_{DDA} - V_{GNDA} = 1.71V$  to  $5.5V$ ,  $V_{DDB} - V_{GNDB} = 1.71V$  to  $5.5V$ ,  $C_L = 15pF$ ,  $T_A = -40^\circ C$  to  $+125^\circ C$ , unless otherwise noted. Typical values are at  $V_{DDA} - V_{GNDA} = 3.3V$ ,  $V_{DDB} - V_{GNDB} = 3.3V$ ,  $GNDA = GNDB$ ,  $T_A = 25^\circ C$ , unless otherwise noted.) (Notes 2,3)

PARAMETER	SYMBOL	CONDITIONS	MIN	TYP	MAX	UNITS
Common-Mode Transient Immunity	CMTI	$IN\_ = GND\_$ or $V_{DD\_}$ (Note 5)		50		kV/ $\mu s$
Maximum Data Rate	$DR_{MAX}$		25			Mbps
Minimum Pulse Width	$PW_{MIN}$				40	ns
Glitch Rejection			10	17	29	ns
Propagation Delay (Figure 1)	$t_{PLH}$	$4.5V \leq V_{DD\_} \leq 5.5V$	17.4	23.9	32.5	ns
		$3.0V \leq V_{DD\_} \leq 3.6V$	17.6	24.4	33.7	
		$2.25V \leq V_{DD\_} \leq 2.75V$	18.3	25.8	36.7	
		$1.71V \leq V_{DD\_} \leq 1.89V$	20.7	29.6	43.5	
	$t_{PHL}$	$4.5V \leq V_{DD\_} \leq 5.5V$	16.9	23.4	33.6	
		$3.0V \leq V_{DD\_} \leq 3.6V$	17.2	24.2	35.1	
		$2.25V \leq V_{DD\_} \leq 2.75V$	17.8	25.4	38.2	
		$1.71V \leq V_{DD\_} \leq 1.89V$	19.8	29.3	45.8	
Pulse Width Distortion	PWD		0.4	4	ns	
Propagation Delay Skew Part-to-Part (same channel)	$t_{SPLH}$	$4.5V \leq V_{DD\_} \leq 5.5V$			15.1	ns
		$3.0V \leq V_{DD\_} \leq 3.6V$			15	
		$2.25V \leq V_{DD\_} \leq 2.75V$			15.4	
		$1.71V \leq V_{DD\_} \leq 1.89V$			20.5	
	$t_{SPHL}$	$4.5V \leq V_{DD\_} \leq 5.5V$			13.9	
		$3.0V \leq V_{DD\_} \leq 3.6V$			14.2	
		$2.25V \leq V_{DD\_} \leq 2.75V$			16	
		$1.71V \leq V_{DD\_} \leq 1.89V$			21.8	
Propagation Delay Skew Channel-to-Channel (Same Direction) MAX12930 only	$t_{SCSLH}$			2	ns	
	$t_{SCSHL}$			2		

**Dynamic Characteristics MAX1293\_B/E (continued)**

( $V_{DDA} - V_{GNDA} = 1.71V$  to  $5.5V$ ,  $V_{DDB} - V_{GNDB} = 1.71V$  to  $5.5V$ ,  $C_L = 15pF$ ,  $T_A = -40^\circ C$  to  $+125^\circ C$ , unless otherwise noted. Typical values are at  $V_{DDA} - V_{GNDA} = 3.3V$ ,  $V_{DDB} - V_{GNDB} = 3.3V$ ,  $GNDA = GNDB$ ,  $T_A = 25^\circ C$ , unless otherwise noted.) (Notes 2,3)

PARAMETER	SYMBOL	CONDITIONS	MIN	TYP	MAX	UNITS
Propagation Delay Skew Channel-to-Channel (Opposite Direction) MAX12931 Only	$t_{SCOLH}$				2	ns
	$t_{SCOHL}$				2	
Peak Eye Diagram Jitter	$T_{JIT(PK)}$	25Mbps		250		ps
Rise Time	$t_R$	$4.5V \leq V_{DD\_} \leq 5.5V$			1.6	ns
		$3.0V \leq V_{DD\_} \leq 3.6V$			2.2	
		$2.25V \leq V_{DD\_} \leq 2.75V$			3	
		$1.71V \leq V_{DD\_} \leq 1.89V$			4.5	
Fall Time	$t_F$	$4.5V \leq V_{DD\_} \leq 5.5V$			1.4	ns
		$3.0V \leq V_{DD\_} \leq 3.6V$			2	
		$2.25V \leq V_{DD\_} \leq 2.75V$			2.8	
		$1.71V \leq V_{DD\_} \leq 1.89V$			5.1	

**Dynamic Characteristics MAX1293\_C/F**

( $V_{DDA} - V_{GNDA} = 1.71V$  to  $5.5V$ ,  $V_{DDB} - V_{GNDB} = 1.71V$  to  $5.5V$ ,  $C_L = 15pF$ ,  $T_A = -40^{\circ}C$  to  $+125^{\circ}C$ , unless otherwise noted. Typical values are at  $V_{DDA} - V_{GNDA} = 3.3V$ ,  $V_{DDB} - V_{GNDB} = 3.3V$ ,  $GNDA = GNDB$ ,  $T_A = 25^{\circ}C$ , unless otherwise noted.) (Notes 2,3)

PARAMETER	SYMBOL	CONDITIONS	MIN	TYP	MAX	UNITS
Common-Mode Transient Immunity	CMTI	$IN_ = GND_$ or $V_{DD-}$ (Note 5)		50		kV/us
Maximum Data Rate	DR <sub>MAX</sub>		150			Mbps
Minimum Pulse Width	PW <sub>MIN</sub>	$2.25V \leq V_{DD-} \leq 5.5V$			5	ns
		$1.71V \leq V_{DD-} \leq 1.89V$			6.67	
Propagation Delay (Figure 1)	t <sub>PLH</sub>	$4.5V \leq V_{DD-} \leq 5.5V$	4.1	5.4	9.2	ns
		$3.0V \leq V_{DD-} \leq 3.6V$	4.2	5.9	10.2	
		$2.25V \leq V_{DD-} \leq 2.75V$	4.9	7.1	13.4	
		$1.71V \leq V_{DD-} \leq 1.89V$	7.1	10.9	20.3	
	t <sub>PHL</sub>	$4.5V \leq V_{DD-} \leq 5.5V$	4.3	5.6	9.4	
		$3.0V \leq V_{DD-} \leq 3.6V$	4.4	6.2	10.5	
		$2.25V \leq V_{DD-} \leq 2.75V$	5.1	7.3	14.1	
		$1.71V \leq V_{DD-} \leq 1.89V$	7.2	10.9	21.7	
Pulse Width Distortion	PWD		0.3	2		ns
Propagation Delay Skew Part-to-Part (same channel)	t <sub>SPLH</sub>	$4.5V \leq V_{DD-} \leq 5.5V$			3.7	ns
		$3.0V \leq V_{DD-} \leq 3.6V$			4.3	
		$2.25V \leq V_{DD-} \leq 2.75V$			6	
		$1.71V \leq V_{DD-} \leq 1.89V$			10.3	
	t <sub>SPHL</sub>	$4.5V \leq V_{DD-} \leq 5.5V$			3.8	
		$3.0V \leq V_{DD-} \leq 3.6V$			4.7	
		$2.25V \leq V_{DD-} \leq 2.75V$			6.5	
		$1.71V \leq V_{DD-} \leq 1.89V$			11.5	
Propagation Delay Skew Channel-to-Channel (same direction) MAX12930 only	t <sub>SCSLH</sub>				2	ns
	t <sub>SCSHL</sub>				2	
Propagation Delay Skew Channel-to-Channel (opposite direction) MAX12931 only	t <sub>SCOLH</sub>				2	ns
	t <sub>SCOHL</sub>				2	
Peak Eye Diagram Jitter	T <sub>JIT(PK)</sub>	150Mbps		90		ps

### Dynamic Characteristics MAX1293\_C/F (continued)

( $V_{DDA} - V_{GNDA} = 1.71V$  to  $5.5V$ ,  $V_{DDB} - V_{GNDB} = 1.71V$  to  $5.5V$ ,  $C_L = 15pF$ ,  $T_A = -40^{\circ}C$  to  $+125^{\circ}C$ , unless otherwise noted. Typical values are at  $V_{DDA} - V_{GNDA} = 3.3V$ ,  $V_{DDB} - V_{GNDB} = 3.3V$ ,  $GNDA = GNDB$ ,  $T_A = 25^{\circ}C$ , unless otherwise noted.) (Notes 2,3)

PARAMETER	SYMBOL	CONDITIONS	MIN	TYP	MAX	UNITS
Rise Time	$t_R$	$4.5V \leq V_{DD\_} \leq 5.5V$			1.6	ns
		$3.0V \leq V_{DD\_} \leq 3.6V$			2.2	
		$2.25V \leq V_{DD\_} \leq 2.75V$			3	
		$1.71V \leq V_{DD\_} \leq 1.89V$			4.5	
Fall Time	$t_F$	$4.5V \leq V_{DD\_} \leq 5.5V$			1.4	ns
		$3.0V \leq V_{DD\_} \leq 3.6V$			2	
		$2.25V \leq V_{DD\_} \leq 2.75V$			2.8	
		$1.71V \leq V_{DD\_} \leq 1.89V$			5.1	

**Note 2:** All devices are 100% production tested at  $T_A = +25^{\circ}C$ . Specifications over temperature are guaranteed by design.

**Note 3:** Not production tested. Guaranteed by design and characterization.

**Note 4:** All currents into the device are positive. All currents out of the device are negative. All voltages are referenced to their respective ground (GNDA or GNDB), unless otherwise noted.

**Note 5:** CMTI is the maximum sustainable common-mode voltage slew rate while maintaining the correct output. CMTI applies to both rising and falling common-mode voltage sedges. Tested with the transient generator connected between GNDA and GNDB ( $V_{CM} = 1000V$ ),

### ESD Protection

PARAMETER	SYMBOL	CONDITIONS	MIN	TYP	MAX	UNITS
ESD		Human Body Model, all pins		$\pm 3$		kV



## Insulation Characteristics

**Table 1. Narrow SOIC Insulation Characteristic**

PARAMETER	SYMBOL	CONDITIONS	VALUE	UNITS
Partial Discharge Test Voltage	$V_{PR}$	Method B1 = $V_{IORM} \times 1.875$ ( $t = 1s$ , partial discharge < 5pC)	1182	$V_P$
Maximum Repetitive Peak Isolation Voltage	$V_{IORM}$	(Note 6)	630	$V_P$
Maximum Working Isolation Voltage	$V_{IOWM}$	Continuous RMS voltage (Note 6)	445	$V_{RMS}$
Maximum Transient Isolation Voltage	$V_{IOTM}$	$t = 1s$	6000	$V_P$
Maximum Withstand Isolation Voltage	$V_{ISO}$	$f_{SW} = 60Hz$ , duration = 60s (Note 7)	3750	$V_{RMS}$
Maximum Surge Isolation Voltage	$V_{IOSM}$	Basic Insulation, 1.2/50 $\mu s$ pulse per IEC61000-4-5	10	kV
Insulation Resistance	$R_S$	$T_A = 150^\circ C$ , $V_{IO} = 500V$	$>10^9$	$\Omega$
Barrier Capacitance Side A to Side B	$C_{IO}$	$f_{SW} = 1MHz$ (Note 8)	2	pF
Minimum Creepage Distance	CPG	Narrow SOIC	4	mm
Minimum Clearance Distance	CLR	Narrow SOIC	4	mm
Internal Clearance		Distance through insulation	0.015	mm
Comparative Tracking Index	CTI	Material Group I (IEC60112)	>600	
Climate Category			40/125/21	
Pollution Degree (DIN VDE 0110, Table 1)			2	

**Table 2. Wide SOIC Insulation Characteristic**

PARAMETER	SYMBOL	CONDITIONS	VALUE	UNITS
Partial Discharge Test Voltage	$V_{PR}$	Method B1 = $V_{IORM} \times 1.875$ ( $t = 1s$ , partial discharge < 5pC)	2250	$V_P$
Maximum Repetitive Peak Isolation Voltage	$V_{IORM}$	(Note 6)	1200	$V_P$
Maximum Working Isolation Voltage	$V_{IOWM}$	Continuous RMS voltage (Note 6)	848	$V_{RMS}$
Maximum Transient Isolation Voltage	$V_{IOTM}$	$t = 1s$	8400	$V_P$
Maximum Withstand Isolation Voltage	$V_{ISO}$	$f_{SW} = 60Hz$ , duration = 60s (Note 7)	5000	$V_{RMS}$
Maximum Surge Isolation Voltage	$V_{IOSM}$	Basic Insulation, 1.2/50 $\mu s$ pulse per IEC61000-4-5	10	kV
Insulation Resistance	$R_S$	$T_A = 150^\circ C$ , $V_{IO} = 500V$	$>10^9$	$\Omega$
Barrier Capacitance Side A to Side B	CIO	$f_{SW} = 1MHz$ (Note 8)	2	pF
Minimum Creepage Distance	CPG	Wide SOIC	8	mm
Minimum Clearance Distance	CLR	Wide SOIC	8	mm
Internal Clearance		Distance through insulation	0.015	mm
Comparative Tracking Index	CTI	Material Group I (IEC60112)	>600	
Climate Category			40/125/21	
Pollution Degree (DIN VDE 0110, Table 1)			2	

**Note 6:**  $V_{ISO}$ ,  $V_{IOWM}$  and  $V_{IORM}$  are defined by the IEC 60747-5-5 standard.

**Note 7:** Product is qualified  $V_{ISO}$  for 60s. 100% production tested at 120% of  $V_{ISO}$  for 1s.

**Note 8:** Capacitance is measured with all pins on field-side and logic-side tied together.

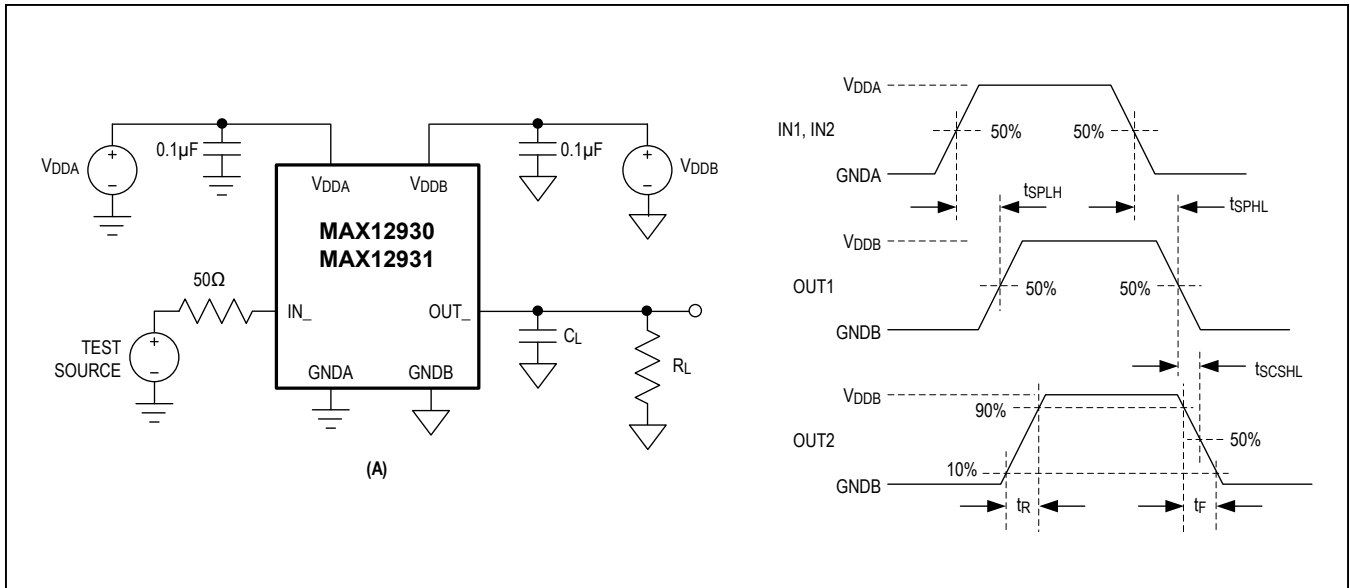
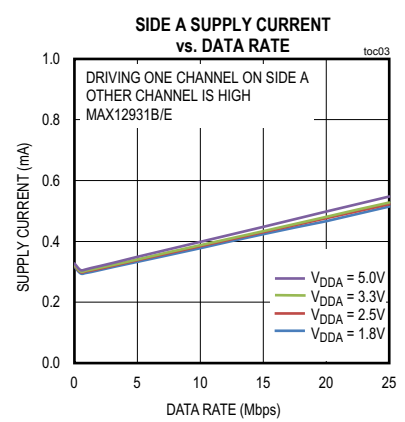
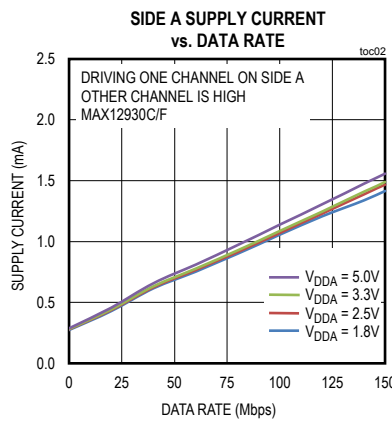
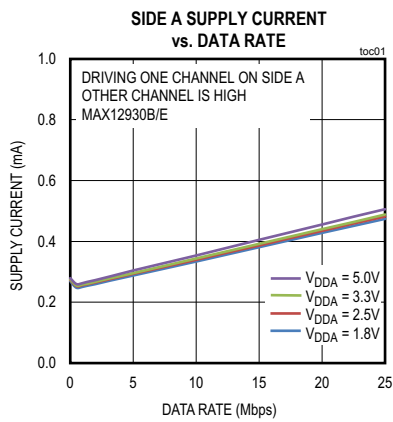

Figure 1. Test Circuit (A) and Timing Diagram (B)

### Typical Operating Characteristics

(V<sub>VDDA</sub> - V<sub>GNDA</sub> = +3.3V, V<sub>VDDB</sub> - V<sub>GNDB</sub> = +3.3V, V<sub>GNDA</sub> = V<sub>GNDB</sub>, T<sub>A</sub> = +25°C, unless otherwise noted.)



Typical Operating Characteristics (continued)

( $V_{DDA} - V_{GNDA} = +3.3V$ ,  $V_{VDDb} - V_{GNDB} = +3.3V$ ,  $V_{GNDA} = V_{GNDB}$ ,  $T_A = +25^\circ C$ , unless otherwise noted.)

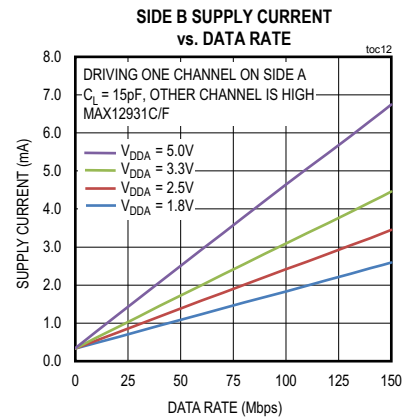
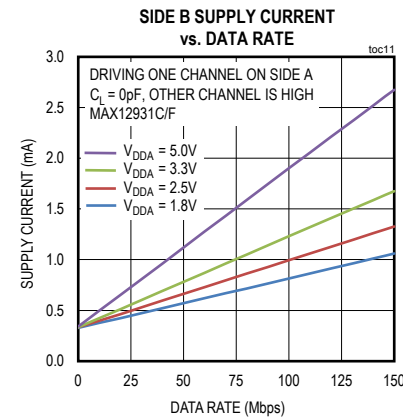
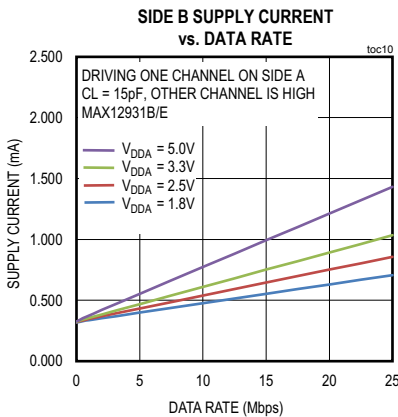
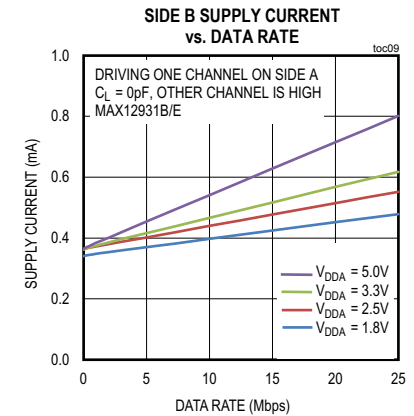
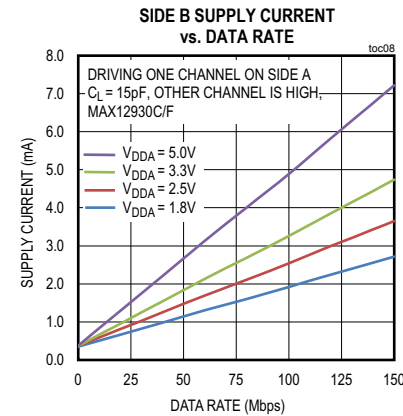
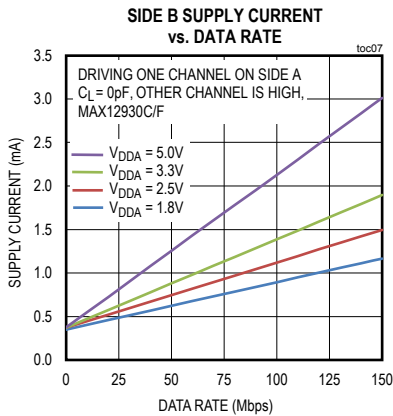
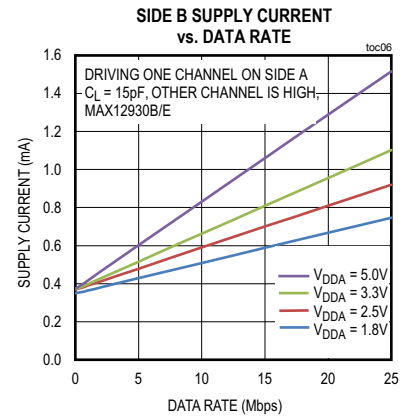
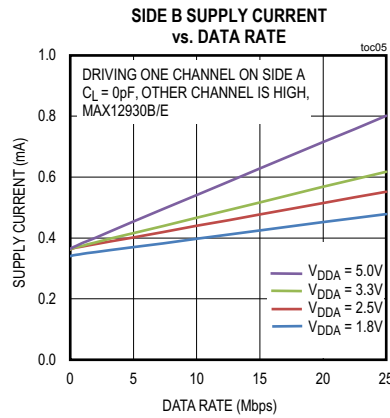
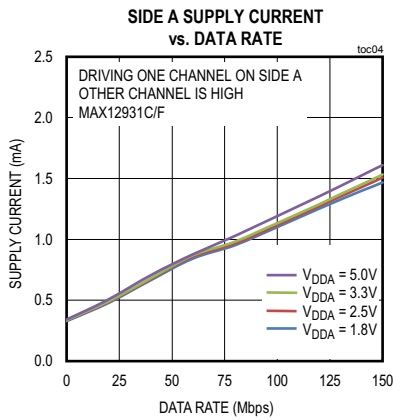

Typical Operating Characteristics (continued)

( $V_{DDA} - V_{GNDA} = +3.3V$ ,  $V_{DDB} - V_{GNDB} = +3.3V$ ,  $V_{GNDA} = V_{GNDB}$ ,  $T_A = +25^\circ C$ , unless otherwise noted.)

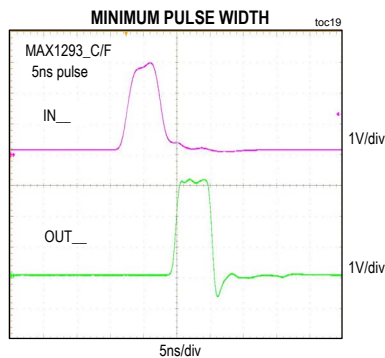
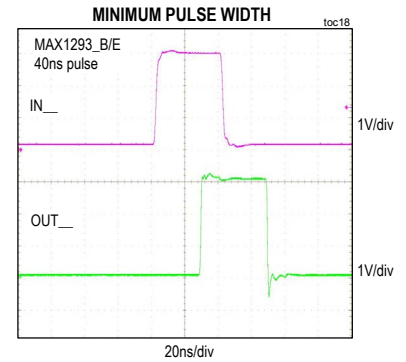
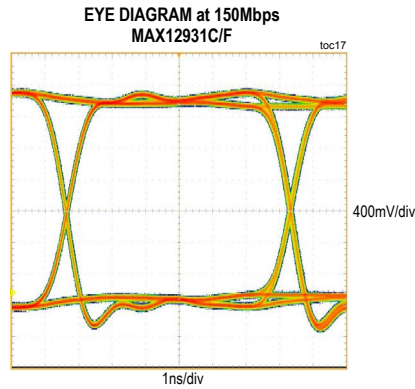
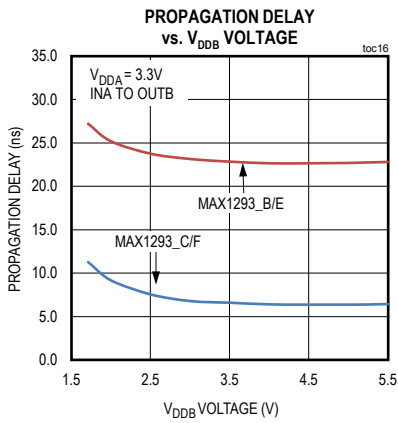
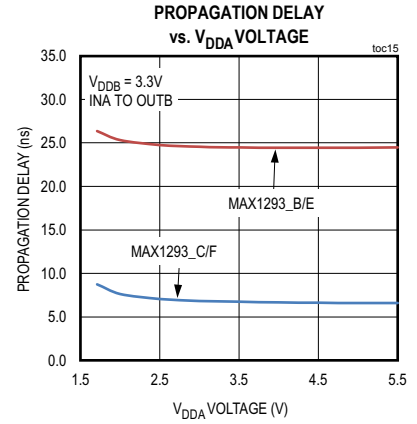
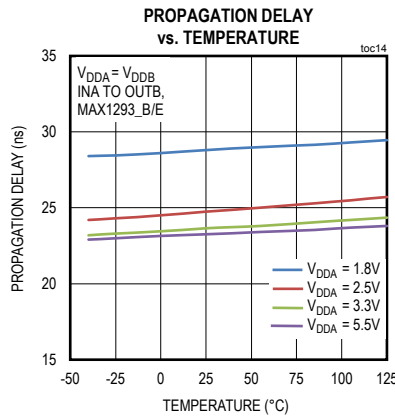
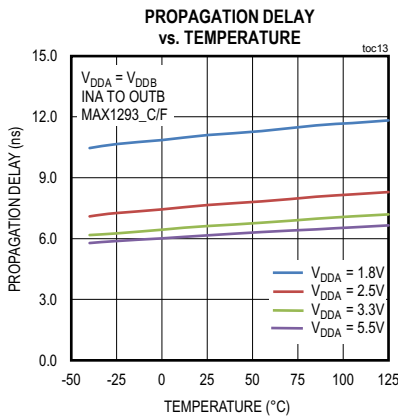

Pin Configurations

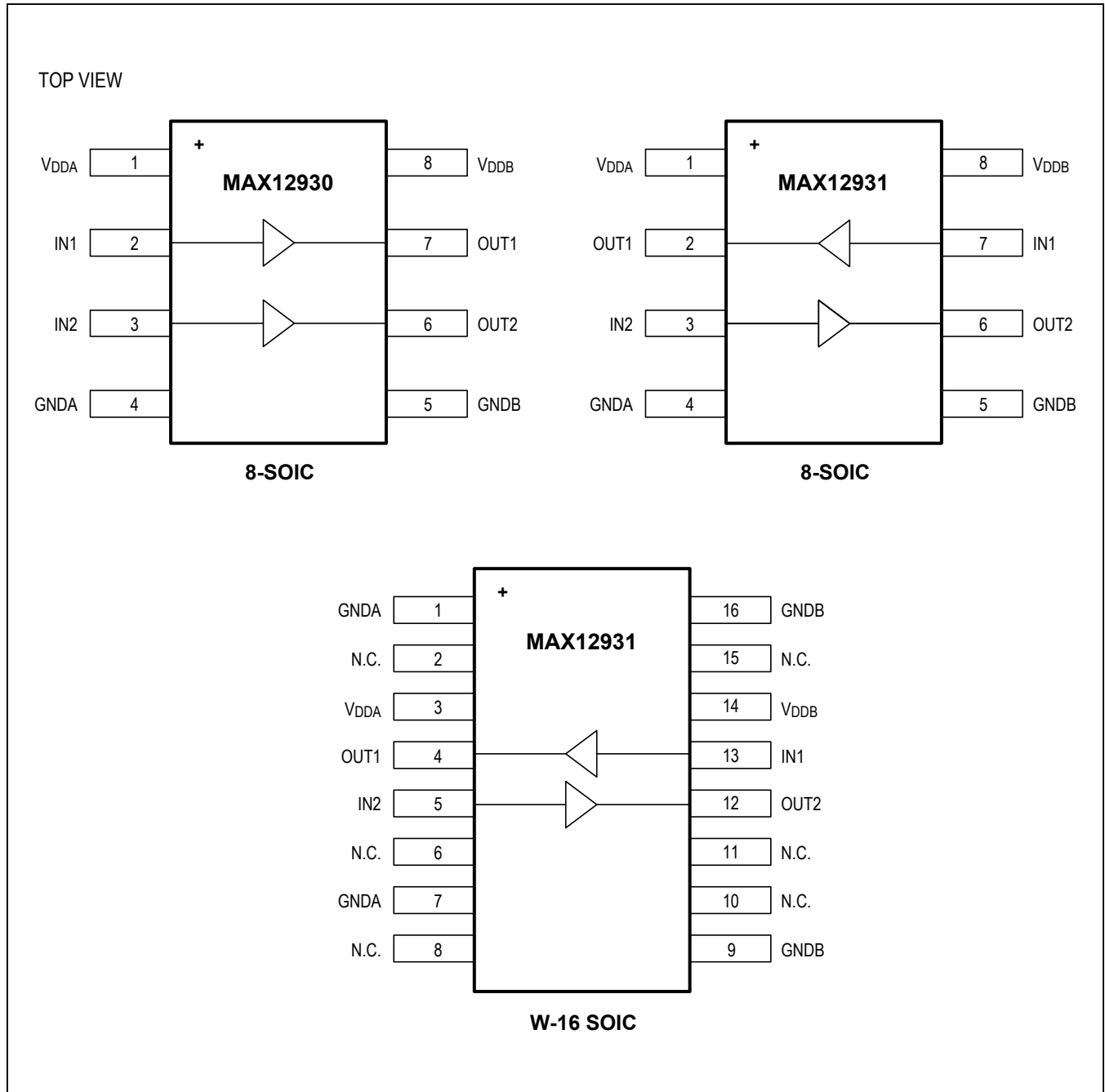

Pin Description

PIN			NAME	FUNCTION	REFERENCE
MAX12930 8-PIN SOIC	MAX12931 8-PIN SOIC	MAX12931 16-PIN SOIC			
1	1	3	V <sub>DDA</sub>	Power Supply for side A. Bypass V <sub>DDA</sub> with a 0.1µF ceramic capacitor to GNDA.	GNDA
2	—	—	IN1	Logic input for channel 1	GNDA
-	2	4	OUT1	Logic output of channel 1	GNDA
3	3	5	IN2	Logic input for channel 2	GNDA
4	4	1, 7	GNDA	Ground reference for side A	—
5	5	9, 16	GNDB	Ground reference for side B	—
6	6	12	OUT2	Logic output of channel 2	GNDB
7	—	—	OUT1	Logic output of channel 1	GNDB
—	7	13	IN1	Logic input for channel 1	GNDB
8	8	14	V <sub>DDB</sub>	Power Supply for side B. Bypass V <sub>DDB</sub> with a 0.1µF ceramic capacitor to GNDB.	GNDB
—	—	2,6,8,10,11,15	N.C.	Not internally connected	—

Typical Operating Circuit

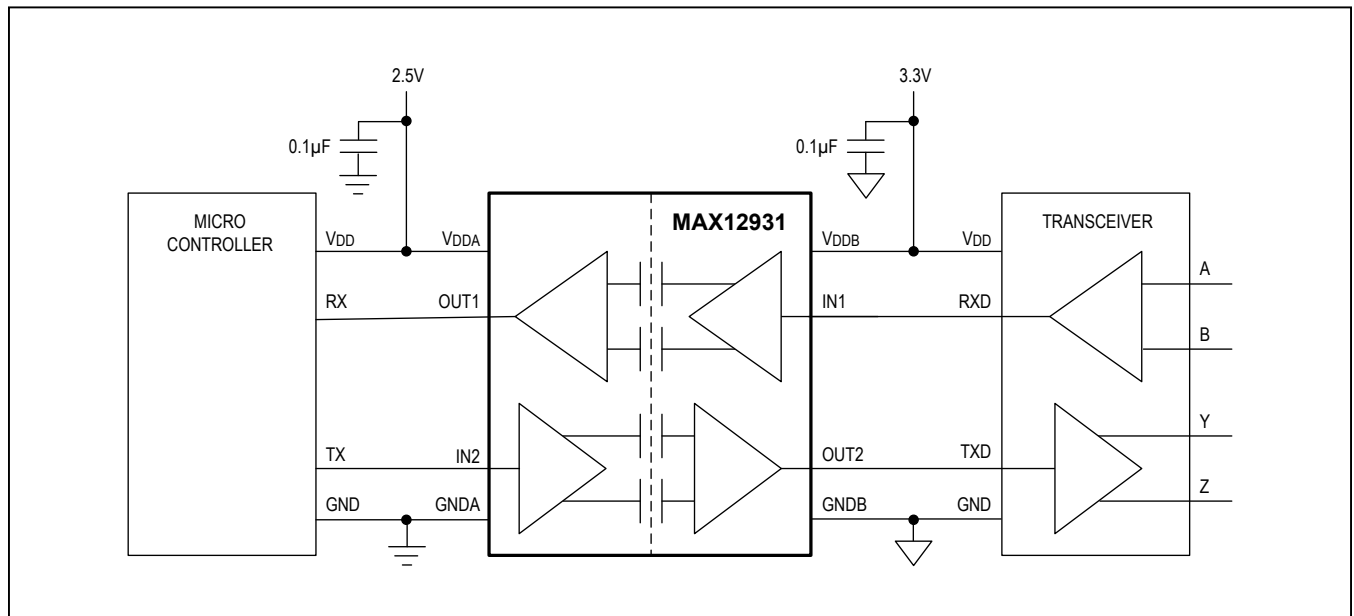

## Detailed Description

The MAX12930/MAX12931 are a family of 2-channel digital isolators. The MAX12930 transfers digital signals between circuits with different power domain in one direction, which is convenient for applications such as digital I/O. The MAX12931 transfers digital signals in opposite directions, which is necessary for isolated RS-485 or other UART applications.

Devices available in the 8-pin narrow body SOIC package are rated for up to 3.75kV<sub>RMS</sub> isolation voltage for 60 seconds and the device in the 16-pin wide body SOIC package is rated for up to 5kV<sub>RMS</sub>. This family of digital isolators offers low-power operation, high electromagnetic interference (EMI) immunity, and stable temperature performance through Maxim's proprietary process technology. The devices isolate different ground domains and block high-voltage/high-current transients from sensitive or human interface circuitry.

Devices are available with data rates from DC to 25Mbps (B/E versions) or 150Mbps (C/F versions). Each device can be ordered with default-high or default-low outputs. The default is the state the output assumes when the input is not powered, or if the input is open circuit.

The devices have two supply inputs ( $V_{DDA}$  and  $V_{DDB}$ ) that independently set the logic levels on either side of device.  $V_{DDA}$  and  $V_{DDB}$  are referenced to  $GNDA$  and  $GNDB$ , respectively. The MAX12930/MAX12931 family also features a refresh circuit to ensure output accuracy when an input remains in the same state indefinitely.

## Digital Isolation

The device family provides galvanic isolation for digital signals that are transmitted between two ground domains. Up to 630V<sub>PEAK</sub> of continuous isolation is supported

in the narrow SOIC package and up to 1200V<sub>PEAK</sub> of continuous isolation is supported in the wide SOIC package. The devices withstand differences of up to 3.75kV<sub>RMS</sub> in the 8-pin narrow SOIC package or 5kV<sub>RMS</sub> in the 16-pin wide SOIC package for up to 60 seconds.

## Level-Shifting

The wide supply voltage range of both  $V_{DDA}$  and  $V_{DDB}$  allows the MAX12930/MAX12931 family to be used for level translation in addition to isolation.  $V_{DDA}$  and  $V_{DDB}$  can be independently set to any voltage from 1.71V to 5.5V. The supply voltage sets the logic level on the corresponding side of the isolator.

## Unidirectional Channels

Each channel of the MAX12930/MAX12931 is unidirectional; it only passes data in one direction, as indicated in the functional diagram. Each device features two unidirectional channels that operate independently with guaranteed data rates from DC up to 25Mbps (B/E versions), or DC to 150Mbps (C/F versions). The output driver of each channel is push-pull, eliminating the need for pullup resistors. The outputs are able to drive both TTL and CMOS logic inputs.

## Startup and Undervoltage-Lockout

The  $V_{DDA}$  and  $V_{DDB}$  supplies are both internally monitored for undervoltage conditions. Undervoltage events can occur during power-up, power-down, or during normal operation due to a sagging supply voltage. When an undervoltage condition is detected on either supply, all outputs go to their default states regardless of the state of the inputs (Table 3). Figure 2 through Figure 5 show the behavior of the outputs during power-up and power-down.

**Table 3. Output Behavior During Undervoltage Conditions**

$V_{IN\_}$	$V_{DDA}$	$V_{DDB}$	$V_{OUTA\_}$	$V_{OUTB\_}$
1	Powered	Powered	1	1
0	Powered	Powered	0	0
X	Undervoltage	Powered	Default	Default
X	Powered	Undervoltage	Default	Default



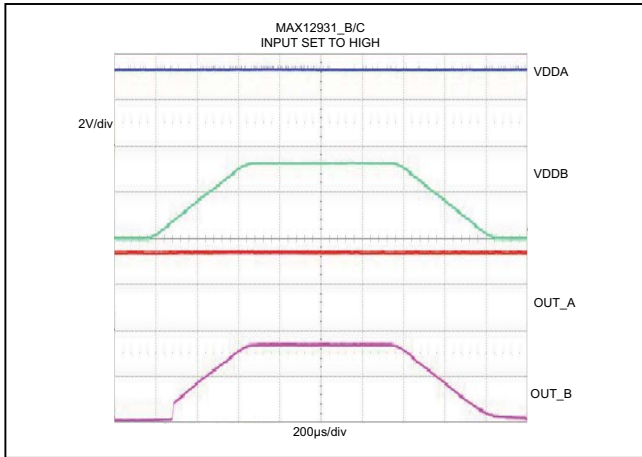

Figure 2. Undervoltage Lockout Behavior (MAX12931B/C High)

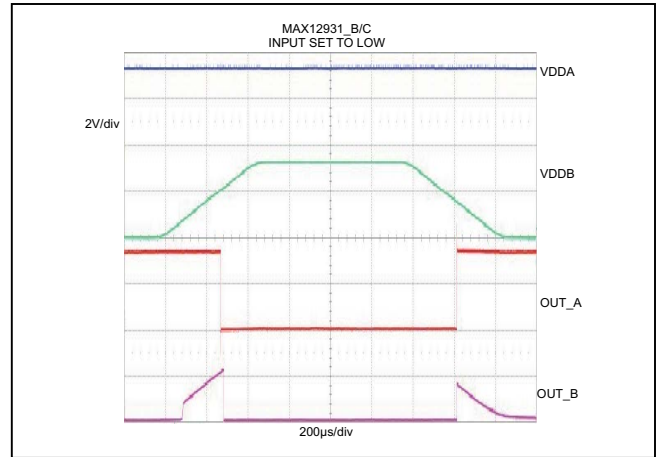

Figure 4. Undervoltage Lockout Behavior (MAX12931B/C Low)

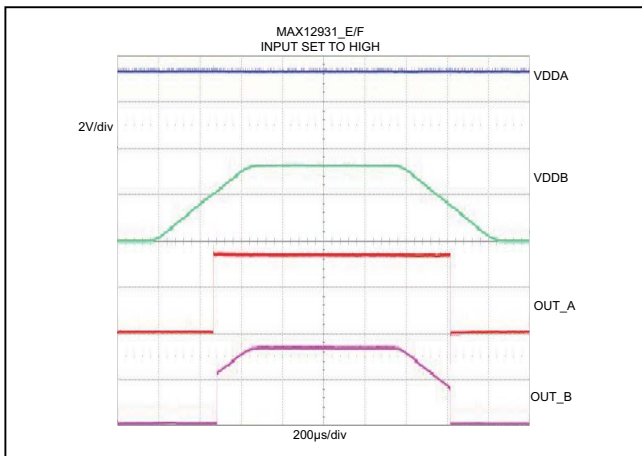

Figure 3. Undervoltage Lockout Behavior (MAX12931E/F High)

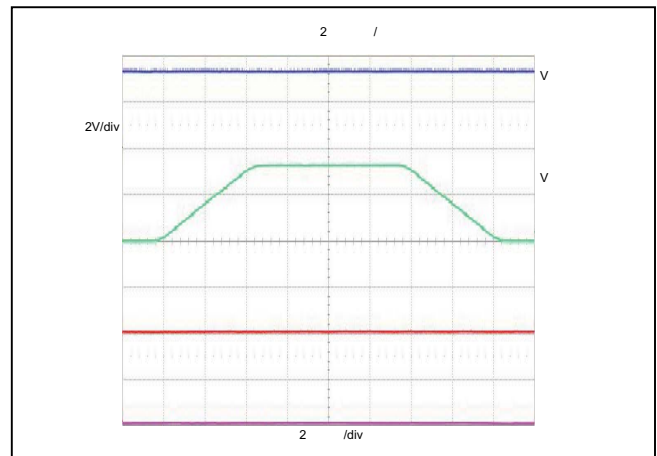

Figure 5. Undervoltage Lockout Behavior (MAX12931E/F Low)

## Application Information

### Power-Supply Sequencing

The MAX12930/MAX12931 do not require special power supply sequencing. The logic levels are set independently on either side by  $V_{DDA}$  and  $V_{DDB}$ . Each supply can be present over the entire specified range regardless of the level or presence of the other supply.

### Power-Supply Decoupling

To reduce ripple and the chance of introducing data errors, bypass  $V_{DDA}$  and  $V_{DDB}$  with 0.1 $\mu$ F low-ESR ceramic capacitors to GNDA and GNDB, respectively. Place the bypass capacitors as close to the power supply input pins as possible.

## Layout Considerations

The PCB designer should follow some critical recommendation in order to get the best performance from the design.

- Keep the input/output traces as short as possible. Avoid using vias to make low-inductance paths for the signals.
- Have a solid ground plane underneath the high-speed signal layer.
- Keep the area underneath the MAX12930/MAX12931 free from ground and signal planes. Any galvanic or metallic connection between the field-side and logic-side defeats the isolation.

## Ordering Information

PART	CHANNEL CONFIGURATION	DATA RATE (MBPS)	DEFAULT OUTPUT	ISOLATION VOLTAGE (KV <sub>RMS</sub> )	TEMP RANGE	PIN-PACKAGE
MAX12930BASA+*	2/0	25	High	3.75	-40°C to 125°C	8 Narrow SOIC
MAX12930CASA+*	2/0	150	High	3.75	-40°C to 125°C	8 Narrow SOIC
MAX12930EASA+*	2/0	25	Low	3.75	-40°C to 125°C	8 Narrow SOIC
MAX12930FASA+*	2/0	150	Low	3.75	-40°C to 125°C	8 Narrow SOIC
MAX12931BASA+*	1/1	25	High	3.75	-40°C to 125°C	8 Narrow SOIC
MAX12931CASA+*	1/1	150	High	3.75	-40°C to 125°C	8 Narrow SOIC
MAX12931EASA+*	1/1	25	Low	3.75	-40°C to 125°C	8 Narrow SOIC
MAX12931FASA+*	1/1	150	Low	3.75	-40°C to 125°C	8 Narrow SOIC
MAX12931BAWE+	1/1	25	High	5.0	-40°C to 125°C	16 Wide SOIC

\*Future product, contact factory for availability

+Denotes a lead(Pb)-free/RoHS-compliant package.

## Chip Information

PROCESS: BICMOS

## Package Information

For the latest package outline information and land patterns (footprints), go to [www.maximintegrated.com/packages](http://www.maximintegrated.com/packages). Note that a "+", "#", or "-" in the package code indicates RoHS status only. Package drawings may show a different suffix character, but the drawing pertains to the package regardless of RoHS status.

PACKAGE TYPE	PACKAGE CODE	OUTLINE NO.	LAND PATTERN NO.
8 Narrow SOIC	S8MS-22	<a href="#">21-0041</a>	<a href="#">90-0096</a>
16 Wide SOIC	W16MS-11	<a href="#">21-0042</a>	<a href="#">90-0107</a>

## Revision History

REVISION NUMBER	REVISION DATE	DESCRIPTION	PAGES CHANGED
0	6/16	Initial release	—

For pricing, delivery, and ordering information, please contact Maxim Direct at 1-888-629-4642, or visit Maxim Integrated's website at [www.maximintegrated.com](http://www.maximintegrated.com).

*Maxim Integrated cannot assume responsibility for use of any circuitry other than circuitry entirely embodied in a Maxim Integrated product. No circuit patent licenses are implied. Maxim Integrated reserves the right to change the circuitry and specifications without notice at any time. The parametric values (min and max limits) shown in the Electrical Characteristics table are guaranteed. Other parametric values quoted in this data sheet are provided for guidance.*