

DATA SHEET

CURRENT SENSOR - LOW TCR

PA0402 series

5%, 1%

sizes 0402

RoHS compliant & Halogen free



SCOPE

This specification describes PA0402 series current sensor - low TCR with lead-free terminations metal substrate.

APPLICATIONS

- Consumer goods
- Computer
- Telecom / Datacom
- Industrial / Power supply
- Alternative Energy
- Car electronics

FEATURES

- Halogen-free Epoxy
- RoHS compliant
- Reduce environmentally hazardous wastes
- High component and equipment reliability
- Non-forbidden materials used in products/production
- Low resistances applied to current sensing
- Moisture sensitivity level: MSL 1

ORDERING INFORMATION - GLOBAL PART NUMBER

Global part numbers are identified by the series, size, tolerance, packing type, temperature coefficient, taping reel and resistance value.

GLOBAL PART NUMBER

PA XXXX X X X XX XXXX L
 (1) (2) (3) (4) (5) (6) (7)

(1) SIZE

0402

(2) TOLERANCE

F = ±1%

J = ±5%

(3) PACKAGING TYPE

R = Paper taping reel

(4) TEMPERATURE COEFFICIENT OF RESISTANCE

J = ± 350 ppm/°C

L = ± 150ppm/°C

(5) TAPING REEL

07 / 7W / 7T / 47 = 7 inch dia. Reel and specific rated power

Detailed power rating are shown in the Table 2.

(6) RESISTANCE VALUE

2.5 mΩ to 20 mΩ

(7) DEFAULT CODE

Letter L is the system default code for ordering only. (Note)

Resistance code rule	Example
0RXXX (2.5 to 50 mΩ)	2U5 = 2.5mΩ 0R001 = 1 mΩ 0R02 = 20 mΩ

ORDERING EXAMPLE

The ordering code for a PA0402 0.25W chip resistor, TC350 value 0.0025Ω (2.5mR) with ±1% tolerance, supplied in 7-inch tape reel with 10Kpcs quantify is: PA0402FRJ472U5L

NOTE

1. All our RChip products are RoHS compliant. "LFP" of the internal 2D reel label mentions "Lead-Free Process"

MARKING

PA0402

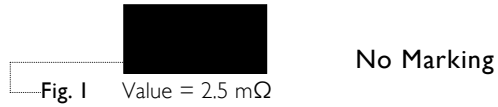

CONSTRUCTION

The resistors are constructed using outstanding TCR level material, which makes Yageo PA resistors excellent for current sensing application in battery charger circuit & DC-DC converter.

The composition of the resistive material is adjusted to give the approximate required resistance and is covered with a protective coating. Marking is printed on the top side of the resistor.

Finally, the three external terminations (Cu / Ni / matte Tin) are added, as shown in Fig. 2.

Outlines

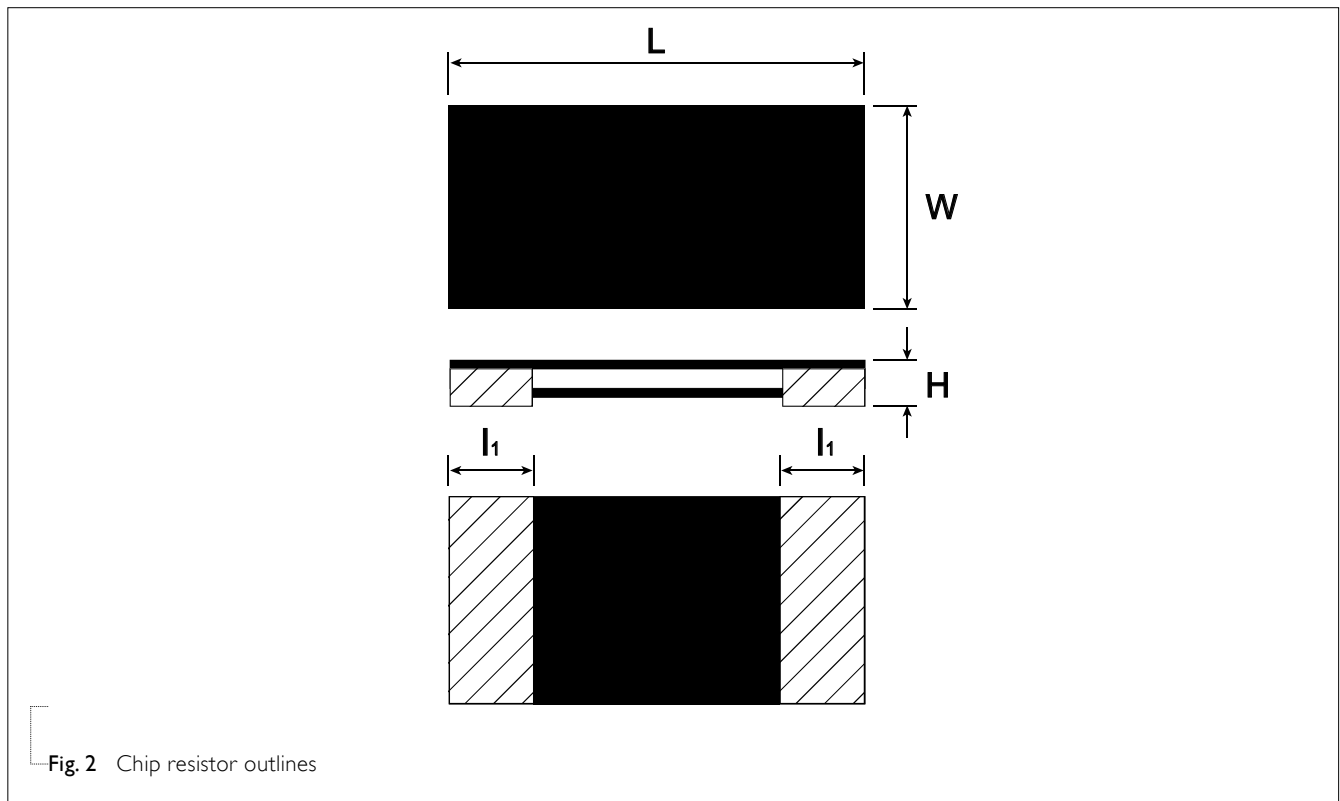

Fig. 2 Chip resistor outlines

DIMENSION

Table 1 For outlines, please refer to Fig. 4

TYPE	RESISTANCE RANGE	POWER RATING	L (mm)	W (mm)	H (mm)	l ₁ (mm)
PA0402	2.5mΩ	1/16 W	1.00±0.10	0.55±0.10	0.30±0.10	0.25±0.10
	5mΩ ≤ R ≤ 10mΩ	1/8 W	1.00±0.10	0.55±0.10	Max. 0.30	0.25±0.10
	12mΩ ≤ R ≤ 20mΩ	1/4 W	1.00±0.10	0.55±0.10	Max. 0.40	0.25±0.10

Note:

1. For relevant physical dimensions, please refer to construction outlines.
2. Please contact with sales offices, distributors and representatives in your region before ordering.

ELECTRICAL CHARACTERISTICS

Table 2

SERIES	SIZE	POWER RATING				TOLERANCE	RESISTANCE RANGE	TEMPERATURE COEFFICIENT OF RESISTANCE
		07	7W	7T	47			
PA	0402	1/16W	1/8W	1/6W	1/4 W	±1%, ±5%	2.5mΩ 5 mΩ ≤ R ≤ 20mΩ	±350 ppm/°C ±150 ppm/°C

Note: Please contact with sales offices, distributors and representatives in your region before ordering.

FUNCTIONAL DESCRIPTION

OPERATING TEMPERATURE RANGE

PA0402 Range: -55°C to +125°C

POWER RATING

Standard rated power at 70°C:

For detail power value, please refer to Table 2.

RATED VOLTAGE

The DC or AC (rms) continuous working voltage corresponding to the rated power is determined by the following formula:

$$V = \sqrt{PxR}$$

Where

V = Continuous rated DC or AC (rms) working voltage (V)

P = Rated power (W)

R = Resistance value (Ω)

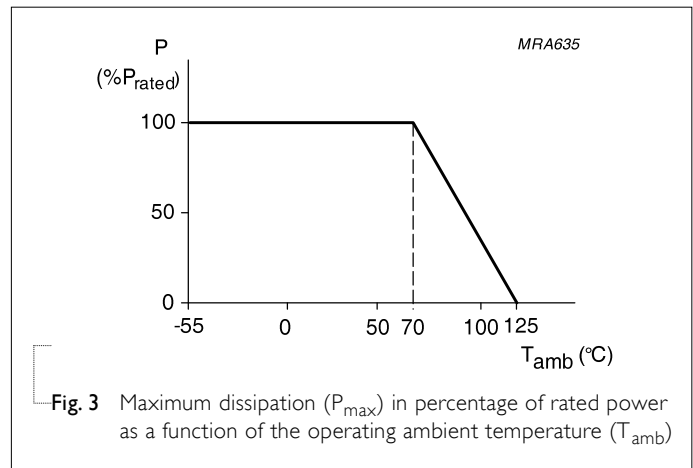

Fig. 3 Maximum dissipation (P_{max}) in percentage of rated power as a function of the operating ambient temperature (T_{amb})

PACKING STYLE AND PACKAGING QUANTITY

Table 3 Packing style and packaging quantity

PACKING STYLE	REEL DIMENSION	PA0402
Paper taping reel (R)	7" (178 mm)	10,000

PAPER TAPE

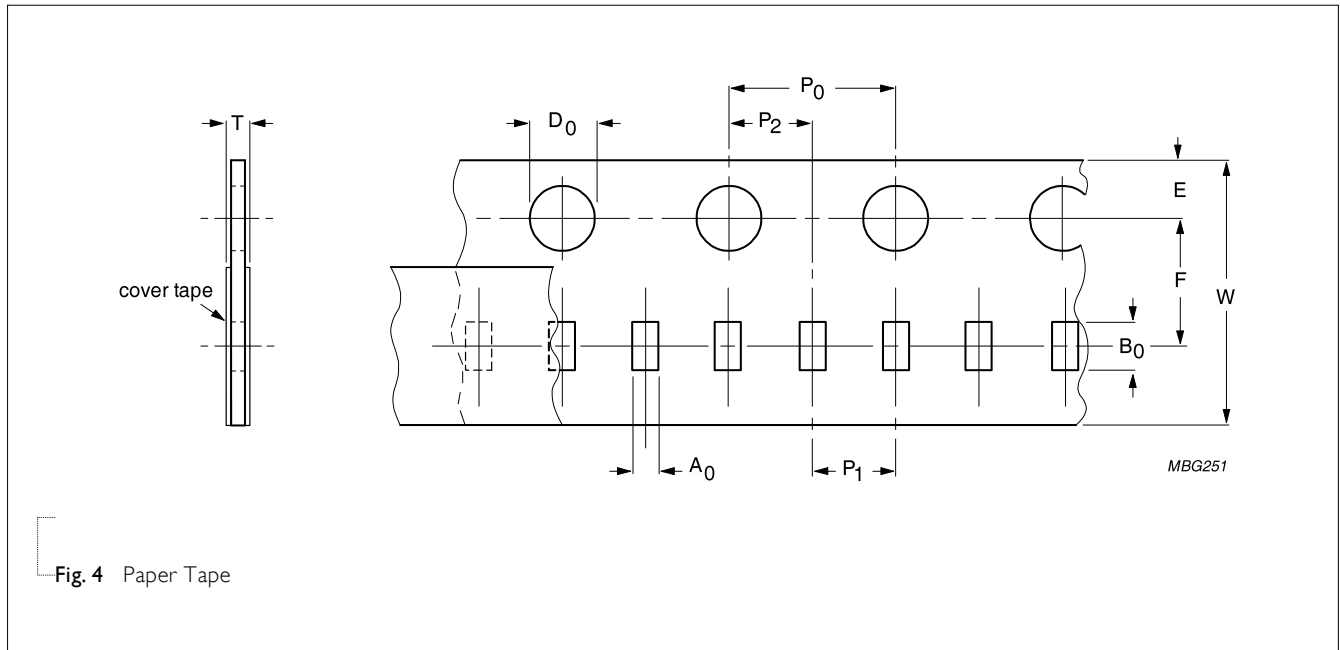

Fig. 4 Paper Tape

Table 4 Dimensions of paper tape for relevant chip resistors size

SIZE	SYMBOL											Unit: mm
	A ₀	B ₀	W	E	F	P ₀	P ₁	P ₂	ØD ₀	ØD ₁	T	
PA0402	0.59±0.10	1.10±0.10	8.00±0.10	1.75±0.10	3.50±0.10	4.00±0.10	4.00±0.10	2.00±0.10	1.55±0.05	1.50±0.10	0.48±0.03	

REEL SPECIFICATION

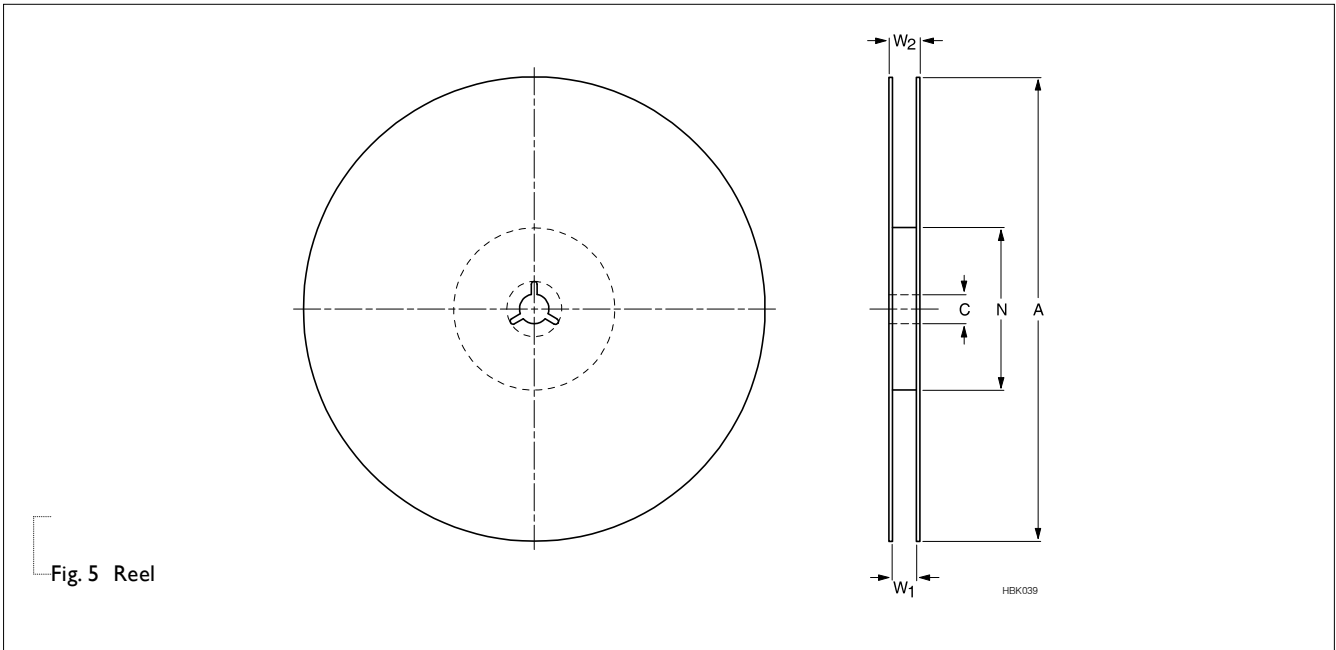
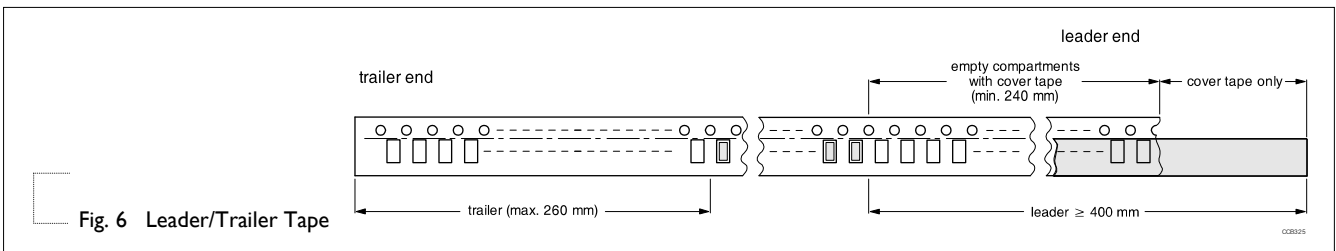

Table 5 Dimensions of reel specification for relevant chip resistors size

SIZE	QUANTITY PER REEL	REEL SIZE 8 mm TAPE WIDE	SYMBOL					Unit: mm	
			A	N	C	D	W ₁	W ₂ MAX.	
PA0402	10,000	7" (Ø178 mm)	178.0±1.0	60.0+1/-0	13.50±0.5	21.0±0.8	9.0±0.5	12.0±0.2	

LEADER/TRAILER TAPE SPECIFICATION



FOOTPRINT AND SOLDERING PROFILES

For recommended soldering profiles, please refer to data sheet “Chip resistors mounting”.

FOOTPRINT

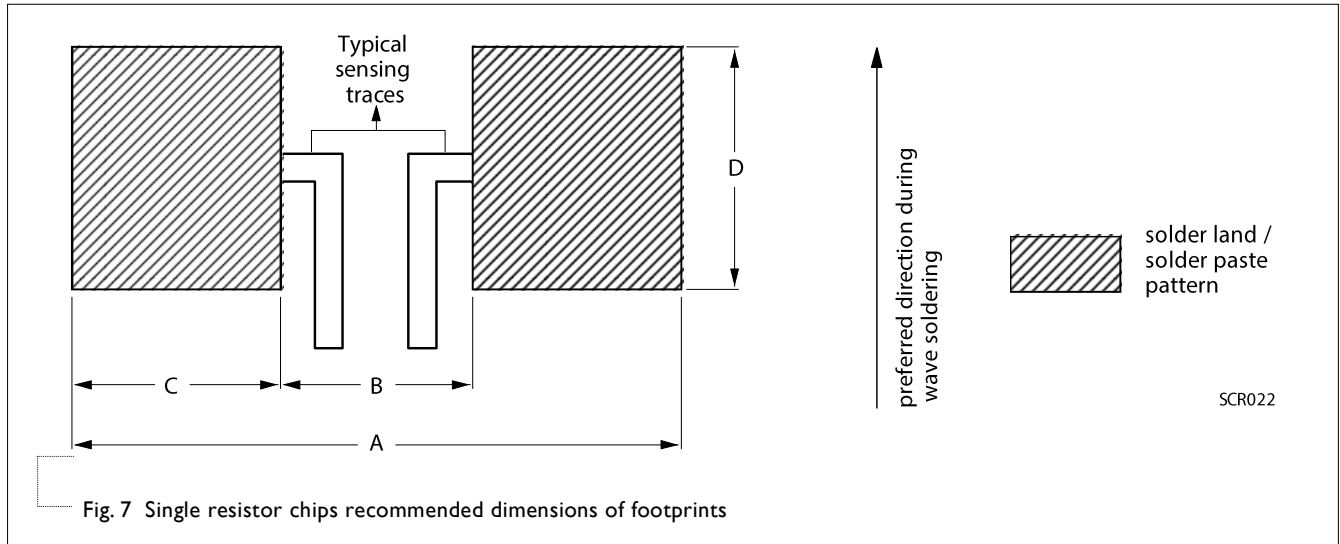

Table 6 Footprint dimensions

SIZE	RESISTANCE RANGE	Unit: mm			
		A	B	C	D
PA0402	2.5mΩ 5mΩ ≤ R ≤ 20mΩ	2.0	0.4	0.8	0.6

TESTS AND REQUIREMENTS
Table 8 Test condition, procedure and requirements

TEST	TEST METHOD	PROCEDURE	REQUIREMENT
Short time overload	IEC60115-1 4.13	2.5 times of rated power for 5 seconds at room temperature	$\pm(1\%+0.0005\Omega)$ No visible damage
High Temperature Exposure	MIL-STD-202-Method 108	1,000 hours at maximum operating temperature depending on specification, unpowered No direct impingement of forced air to the parts Tolerances: $125\pm5^\circ\text{C}$	$\pm(1.0\%+0.0005\Omega)$
Moisture Resistance	MIL-STD-202-Method 106	Each temperature / humidity cycle is defined at 8 hours (method 106F), 3 cycles / 24 hours for 10d with 25°C / 65°C 95% R.H, without steps 7a & 7b, unpowered	$\pm(0.5\%+0.0005\Omega)$
Operational Life/ Endurance	MIL-STD-202 Method 108 IEC 60115-1 4.25.1	1,000 hours at $70\pm2^\circ\text{C}$ applied RCWV 1.5 hours on, 0.5 hour off, still air required	$\pm(1.0\%+0.0005\Omega)$
Resistance to Soldering Heat	MIL-STD-202-method 210	Condition B, no pre-heat of samples Leadfree solder, 260°C , 10 seconds immersion time Procedure 2 for SMD: devices fluxed and cleaned with isopropanol	$\pm(0.5\%+0.0005\Omega)$ No visible damage
Thermal Shock	MIL-STD-202 Method 107	$-55/+125^\circ\text{C}$, Number of cycles is 300. Devices mounted. Maximum transfer time is 20 seconds. Dwell time is 15 minutes. Air -Air	$\pm(1\%+0.0005\Omega)$ No visible damage
Solderability - Wetting	J-STD-002 test B	Electrical Test not required Magnification 50X SMD conditions: 1st step : method B, aging 4 hours at 155°C dry heat 2nd step : leadfree solder bath at $245\pm3^\circ\text{C}$ Dipping time: 3 ± 0.5 seconds	Well tinned (>95% covered) No visible damage
Board Flex / Bending	IEC 60115-1 4.33	Chips mounted on a 90mm glass epoxy resin PCB (FR4), Bending for 0402=2 mm Holding time: Min.60 seconds	$\pm(1.0\%+0.0005\Omega)$

REVISION HISTORY

REVISION	DATE	CHANGE NOTIFICATION	DESCRIPTION
Version 0	Mar. 23, 2017	-	- New datasheet for automotive grade current sensor –PA0402 series.

“Yageo reserves all the rights for revising the content of this datasheet without further notification, as long as the products itself are unchanged. Any product change will be announced by PCN.”