

## Precision Dual Voltage Reference

### FEATURES

- $\pm 10$  V Output,  $\pm 1.6$  mV
- Temperature Drift: 1.0 ppm/°C
- Low Noise: 6  $\mu$ V<sub>p-p</sub> (0.1-10 Hz)
- Tracking Error: 0.3 mV
- Excellent Line Regulation: 6 ppm/V Typical
- Surface Mount Package

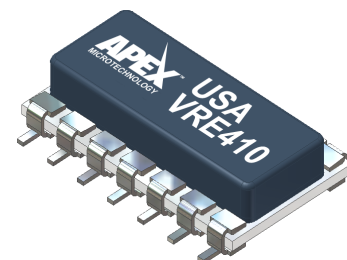

### APPLICATIONS

The VRE410 is recommended for use as a reference for high precision D/A and A/D converters which require an external precision reference. The device is also ideal for calibrating scale factor on high resolution A/D converters. The VRE410 offers superior performance over monolithic references.

### DESCRIPTION

The VRE410 is a low cost, high precision,  $\pm 10$  V reference. Available in a 14-pin SMT package, the device is ideal for new designs that need a high performance reference.

The device provides ultrastable  $\pm 10$  V output with  $\pm 1.6$  mV initial accuracy and a temperature coefficient of 1.0 ppm/°C. This improvement in accuracy is made possible by a unique, patented multipoint laser compensation technique.

Another key feature of this reference is the 0.5 mV tracking error between the positive and negative output voltages over the full operating temperature range. This is extremely important in high performance systems for reducing overall system errors.

### SELECTION GUIDE

Model	Initial Error (mV)	Temp. Coeff. (ppm/°C)	Temp Range (°C)
VRE410AS	$\pm 1.6$	1.0	0°C to +70°C
VRE410BS	$\pm 2.0$	2.0	0°C to +70°C
VRE410JS	$\pm 1.6$	1.0	-40°C to +85°C
VRE410LS	$\pm 2.2$	2.2	-40°C to +85°C

## TYPICAL CONNECTION

Figure 1: Typical Connection

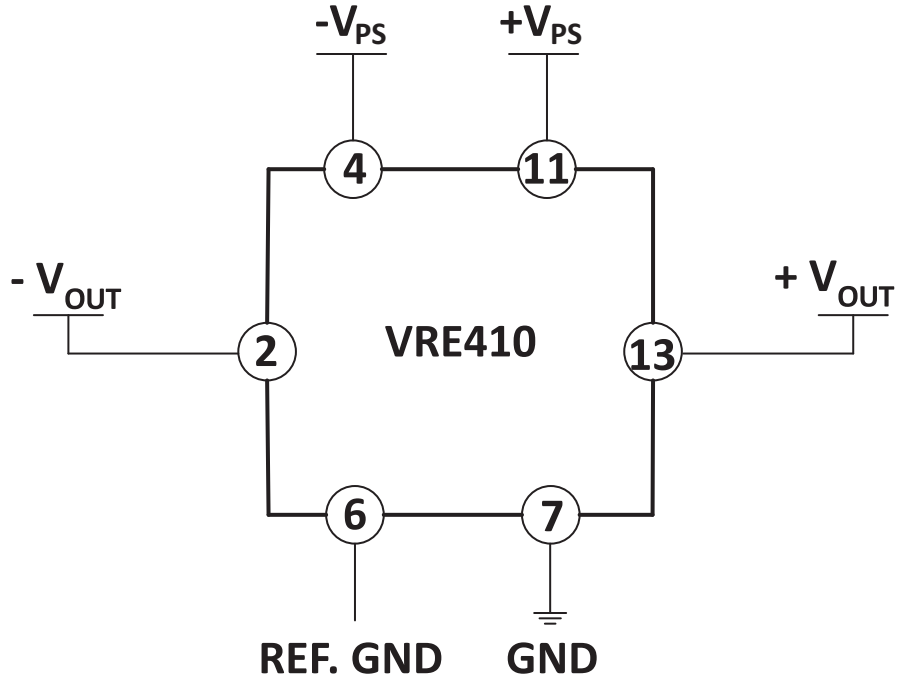

### PIN DESCRIPTIONS

Pin Number	Name	Description
2	-OUT	-10 V output.
4	$-V_{PS}$	The negative supply voltage connection.
6	REF_GND	Provided for accurate ground sensing. Internally connected to GND.
7	GND	Ground.
11	$+V_{PS}$	The positive supply voltage connection.
13	+OUT	+10 V output.
All Others	NC	No connection.

**SPECIFICATIONS**

$V_{PS} = +15\text{ V}$ ,  $T = +25^{\circ}\text{C}$ ,  $R_L = 10\text{ k}\Omega$  unless otherwise noted.

**ABSOLUTE MAX RATINGS**

Parameter	A/J			B			L			Units
	Min	Typ	Max	Min	Typ	Max	Min	Typ	Max	
Power Supply	±13.5	±15	±22	*	*	*	*	*	*	V
Operating Temperature (A,B)	0		+70	*		*	*		*	°C
Operating Temperature (J,L)	-40		+85	*		*	*		*	°C
Storage Temperature	-65		+150	*		*	*		*	°C
Short Circuit Protection	Continuous			*			*			

**ELECTRICAL SPECIFICATIONS**

Parameter	A/J			B			L			Units
	Min	Typ	Max	Min	Typ	Max	Min	Typ	Max	
Output Voltage		±10.0			*			*		V
Initial Error <sup>1</sup>			±1.60			±2.00			±2.20	mV
Warmup Drift		1			2			3		ppm
$T_{MIN} - T_{MAX}$ <sup>2</sup>			1.0			2.0			2.2	ppm/°C
Tracking Error <sup>3</sup>		0.5			0.7			1.0		mV
Long-Term Stability		6			*			*		ppm/ 1000hrs
Noise (0.1 - 10Hz)		6			*			*		µVpp
Output Current	±10			*						mA
Line Regulation		3			*			*		ppm/V
Load Regulation		3			*			*		ppm/ mA
Power Supply Current, +PS <sup>4</sup>		7			*			*		mA
Power Supply Current, -PS <sup>4</sup>		4			*			*		mA

1. The specified values are without external trim.
2. The temperature coefficient (TC) is determined by the box method using the following formula:

$$TC = \frac{V_{MAX} - V_{MIN}}{V_{NOMINAL} \times (T_{MAX} - T_{MIN})} \times 10^6$$

3. The tracking error is the deviation between the positive and negative output over the operating temp. range.
4. The specified values are unloaded.

**Note:** \* Same as A/J Models

TYPICAL PERFORMANCE GRAPHS

Figure 2:  $V_{OUT}$  vs. Temperature (VRE410AS)

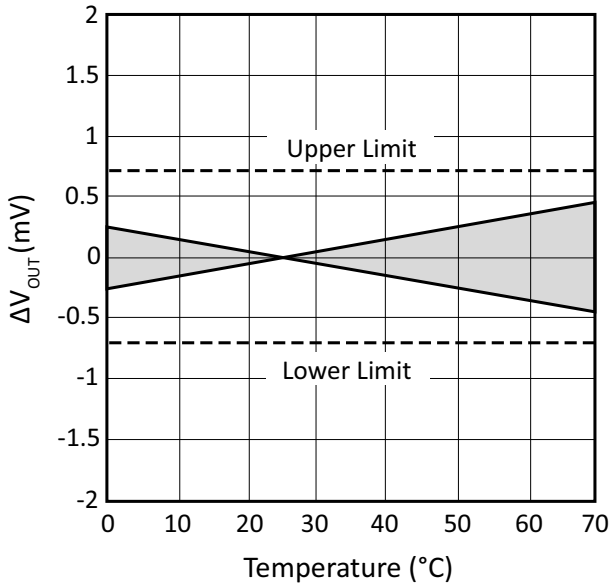

Figure 3:  $V_{OUT}$  vs. Temperature (VRE410BS)

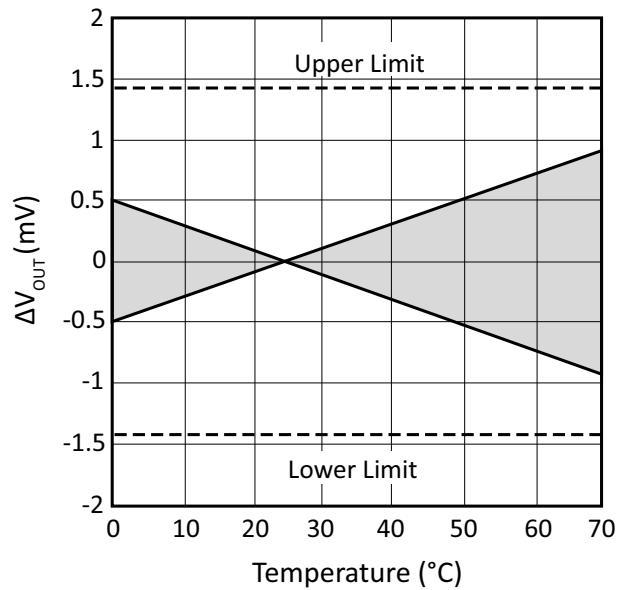

Figure 4:  $V_{OUT}$  vs. Temperature (VRE410JS)

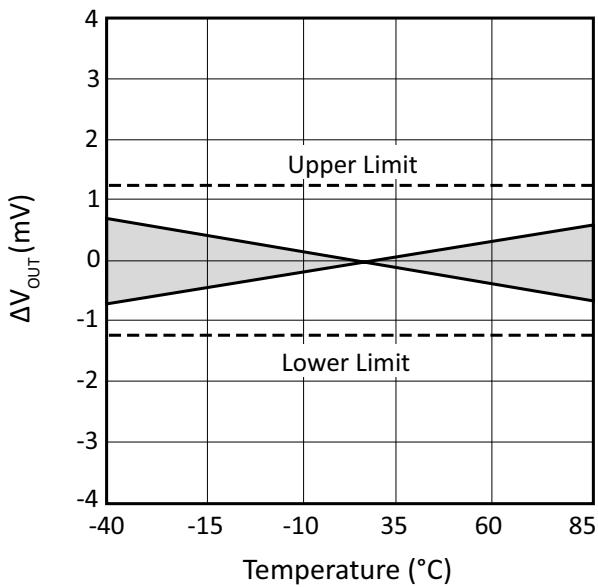
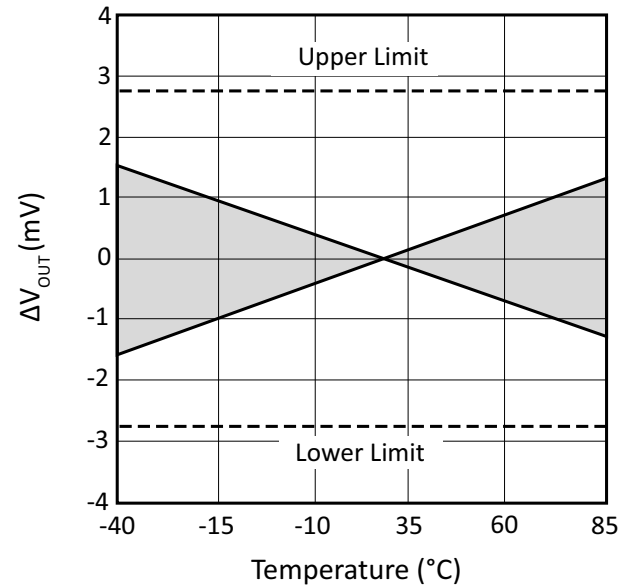
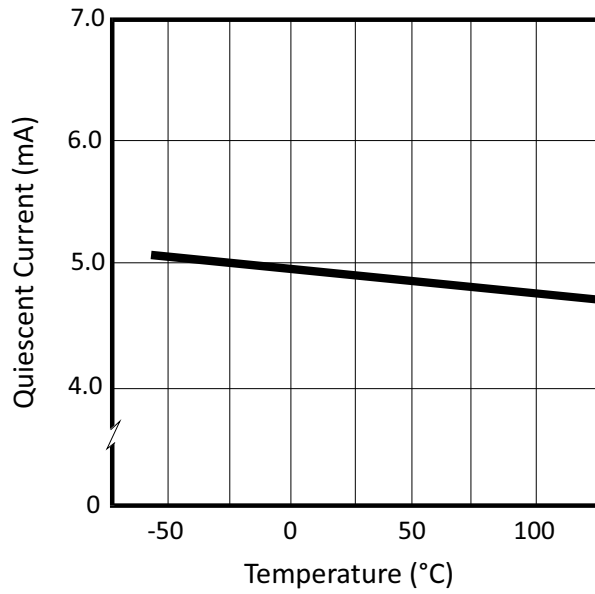

Figure 5:  $V_{OUT}$  vs. Temperature (VRE410LS)



**POSITIVE OUTPUT (TYP)**

**Figure 6: Quiescent Current vs. Temperature**



**Figure 7: Junction Temp Rise vs. Output Current**

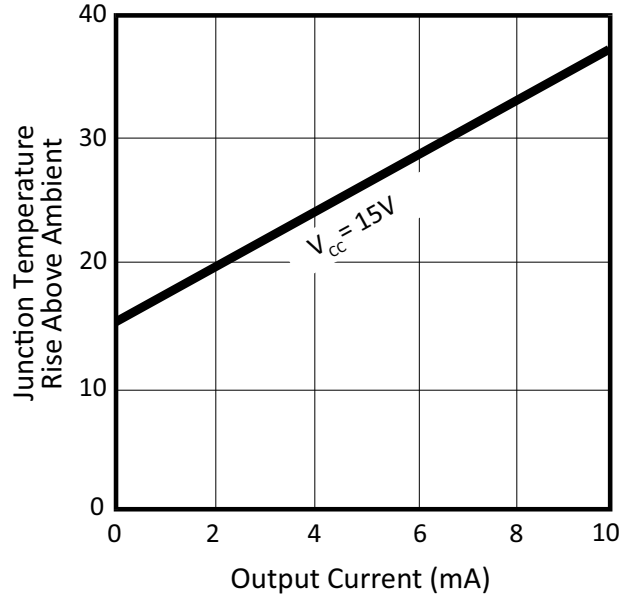

**Figure 8: PSRR vs. Frequency**

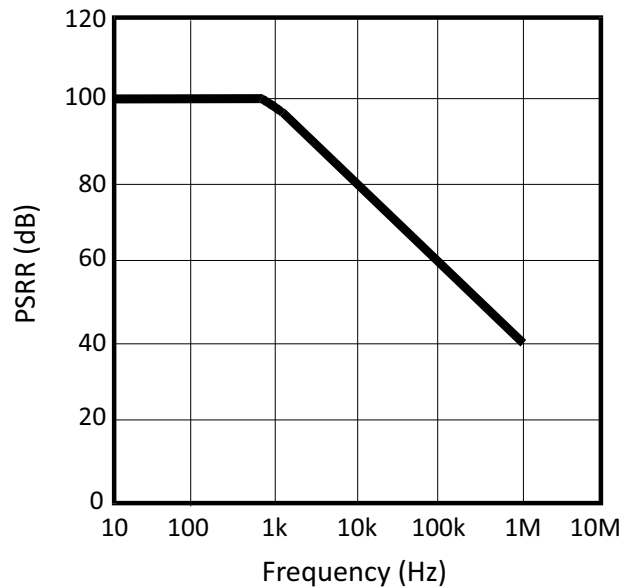

NEGATIVE OUTPUT (TYP)

Figure 9: Quiescent Current vs. Temperature

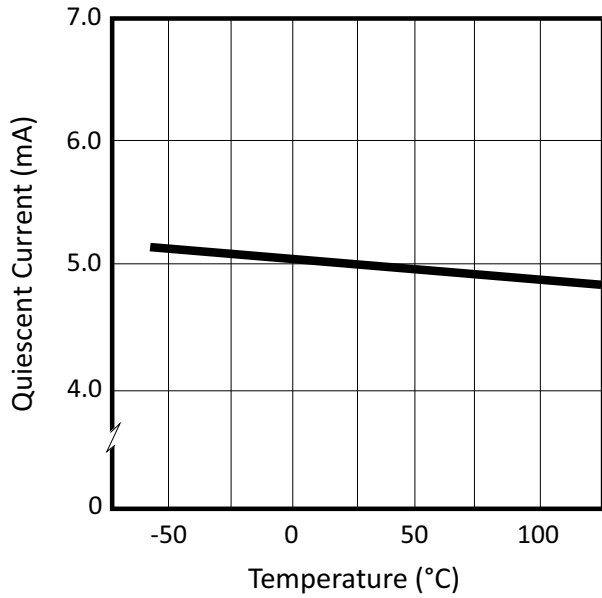

Figure 10: Junction Temp Rise vs. Output Current

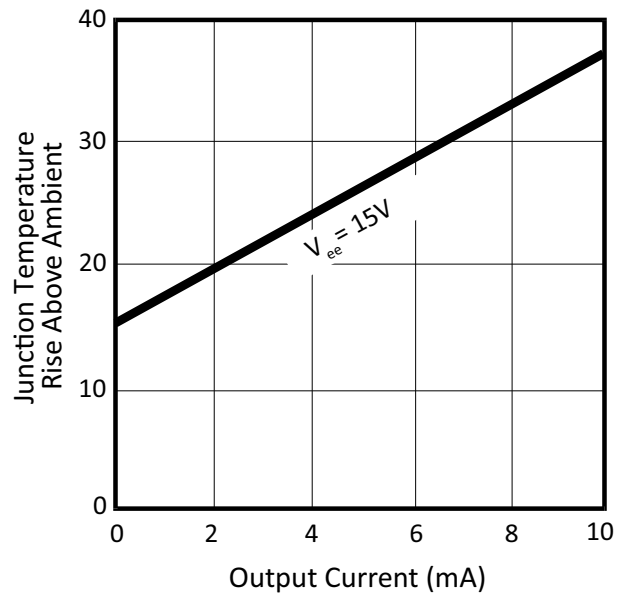
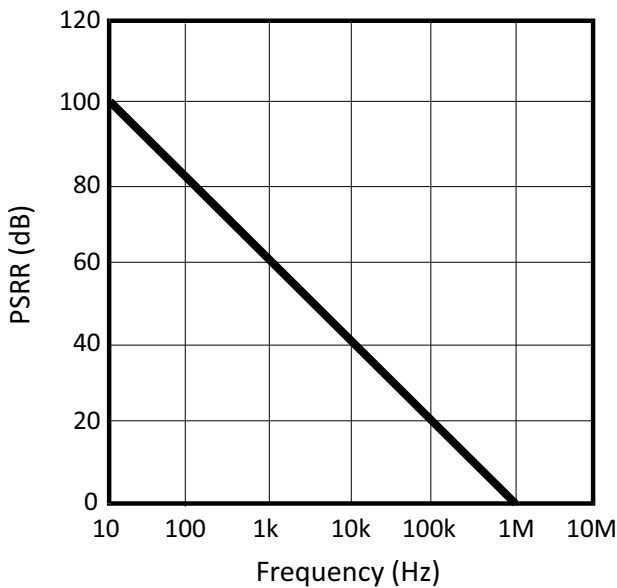
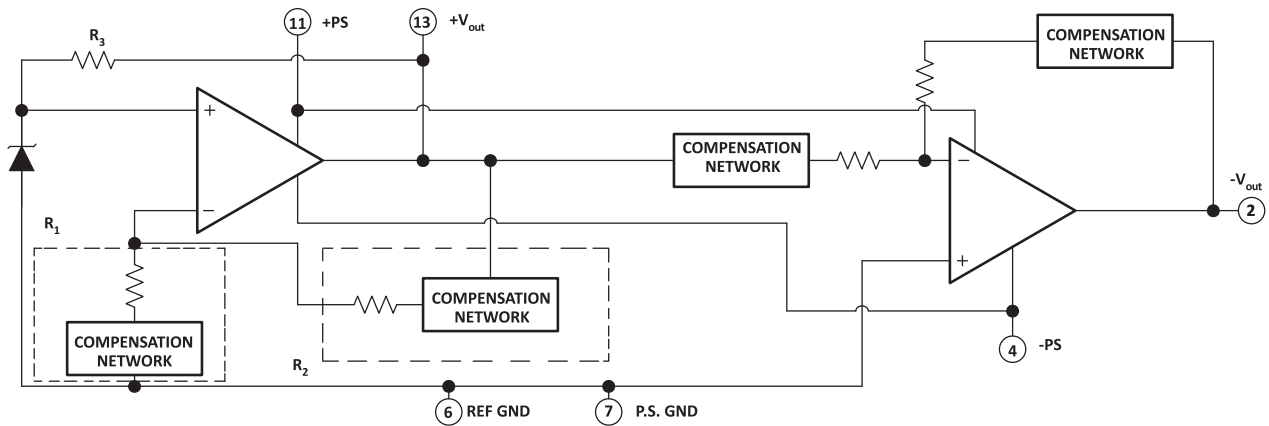

Figure 11: PSRR vs. Frequency



**BLOCK DIAGRAM**

**Figure 12: Block Diagram**



**THEORY OF OPERATION**

The following discussion refers to the block diagram in Figure 12. In operation, approximately 6.3 V is applied to the noninverting input of the op amp. The voltage is amplified by the op amp to produce a 10 V output. The gain is determined by the networks R1 and R2:  $G=1 + R2/R1$ . The 6.3 V zener diode is used because it is the most stable diode over time and temperature.

The zener operating current is derived from the regulated output voltage through R3. This feedback arrangement provides a closely regulated zener current. This current determines the slope of the references' voltage vs. temperature function. By trimming the zener current a lower drift over temperature can be achieved. But since the voltage vs. temperature function is nonlinear this compensation technique is not well suited for wide temperature ranges.

A nonlinear compensation network of thermistors and resistors is used in the VRE series voltage references. This proprietary network eliminates most of the nonlinearity in the voltage vs. temperature function. By then adjusting the slope, a very stable voltage is produced over wide temperature ranges.

The VRE400 series voltage references have the ground terminal brought out on two pins (pin 6 and 7) which are connected together internally. This allows the user to achieve greater accuracy when using a socket. Voltage references have a voltage drop across their power supply ground pin due to quiescent current flowing through the contact resistance. If the contact resistance was constant with time and temperature, this voltage drop could be trimmed out. When the reference is plugged into a socket, this source of error can be as high as 20 ppm. By connecting pin 7 to the power supply ground and pin 6 to a high impedance ground point in the measurement circuit, the error due to the contact resistance can be eliminated. If the unit is soldered into place the contact resistance is sufficiently small that it doesn't effect performance.

## PIN CONFIGURATION

Figure 13: Pin Configuration

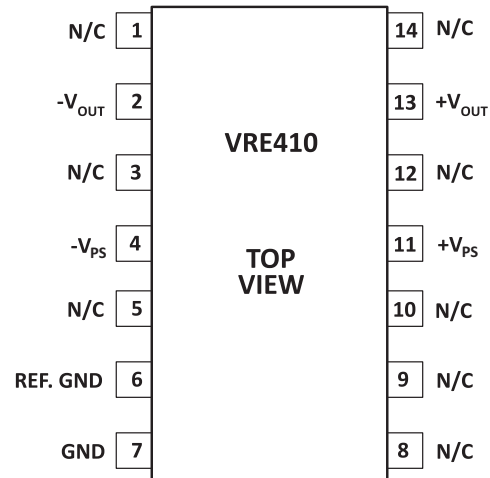



**PACKAGE OPTIONS**

Part Number	Apex Package Style	Description
VRE410AS	GE	14-pin SMT DIP
VRE410BS	GE	14-pin SMT DIP
VRE410JS	GE	14-pin SMT DIP
VRE410LS	GE	14-pin SMT DIP

**PACKAGE STYLE GE**

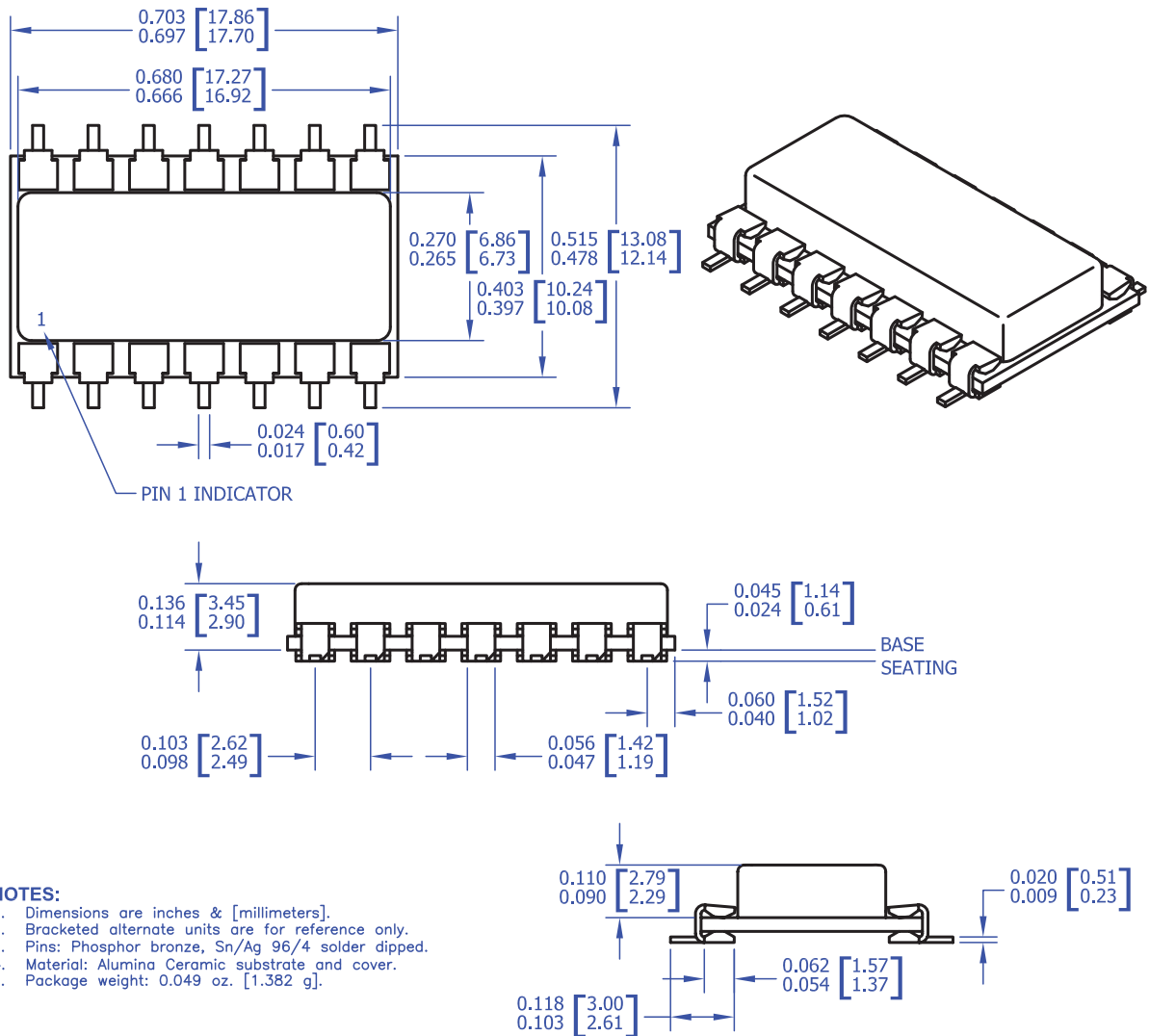

---

## NEED TECHNICAL HELP? CONTACT APEX SUPPORT!

For all Apex Microtechnology product questions and inquiries, call toll free 800-546-2739 in North America. For inquiries via email, please contact [apex.support@apexanalog.com](mailto:apex.support@apexanalog.com). International customers can also request support by contacting their local Apex Microtechnology Sales Representative. To find the one nearest to you, go to [www.apexanalog.com](http://www.apexanalog.com)

---

### IMPORTANT NOTICE

Apex Microtechnology, Inc. has made every effort to insure the accuracy of the content contained in this document. However, the information is subject to change without notice and is provided "AS IS" without warranty of any kind (expressed or implied). Apex Microtechnology reserves the right to make changes without further notice to any specifications or products mentioned herein to improve reliability. This document is the property of Apex Microtechnology and by furnishing this information, Apex Microtechnology grants no license, expressed or implied under any patents, mask work rights, copyrights, trademarks, trade secrets or other intellectual property rights. Apex Microtechnology owns the copyrights associated with the information contained herein and gives consent for copies to be made of the information only for use within your organization with respect to Apex Microtechnology integrated circuits or other products of Apex Microtechnology. This consent does not extend to other copying such as copying for general distribution, advertising or promotional purposes, or for creating any work for resale.

APEX MICROTECHNOLOGY PRODUCTS ARE NOT DESIGNED, AUTHORIZED OR WARRANTED TO BE SUITABLE FOR USE IN PRODUCTS USED FOR LIFE SUPPORT, AUTOMOTIVE SAFETY, SECURITY DEVICES, OR OTHER CRITICAL APPLICATIONS. PRODUCTS IN SUCH APPLICATIONS ARE UNDERSTOOD TO BE FULLY AT THE CUSTOMER OR THE CUSTOMER'S RISK.

Apex Microtechnology, Apex and Apex Precision Power are trademarks of Apex Microtechnology, Inc. All other corporate names noted herein may be trademarks of their respective holders.