

CPDQC3V3C-HF

RoHS Device
Halogen Free



Features

- Bi-directional ESD protection.
- IEC 61000-4-2 (ESD) ; ±20 KV (Contact)
- ESD rating of Class 3B per Human Body Mode.
- Surface mount package.
- Ultra small SMD package:0402.
- High component density.

Mechanical data

- Case: 0402C/SOD-923F standard package, molded plastic.
- Terminals: Gold plated, solderable per MIL-STD-750, method 2026.
- Marking Code: E3
- Mounting position: Any.
- Weight: 0.001 grams(approx.).

Circuit diagram

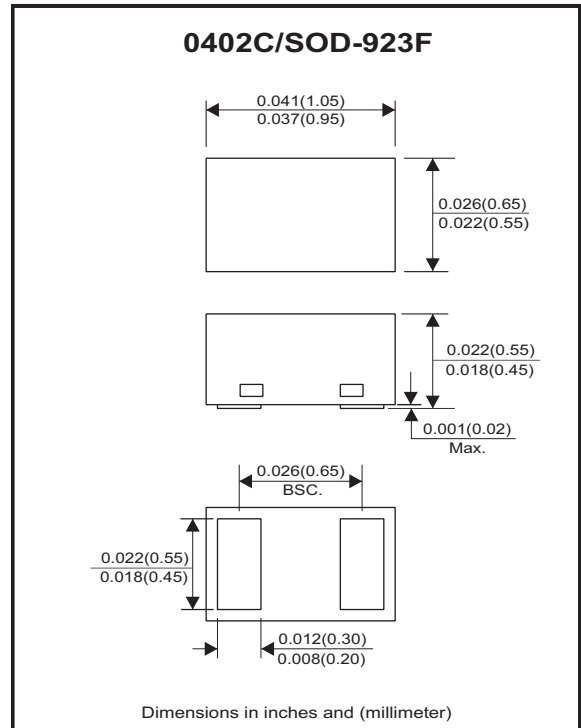

Maximum Rating (at TA=25°C unless otherwise noted)

Parameter	Conditions	Symbol	Value	Unit
Peak pulse power	T _P = 8/20us	P _{PP}	65	W
Peak pulse current	T _P = 8/20us	I _{PP}	5	A
ESD capability	IEC 61000-4-2(Air) IEC 61000-4-2(Contact)	V _{ESD}	±20	kV
Operating temperature range		T _J	-55 to +125	°C
Storage temperature range		T _{STG}	-55 to +125	°C

Electrical Characteristics (at TA=25°C unless otherwise noted)

Parameter	Conditions	Symbol	Min	Typ	Max	Unit
Working peak reverse voltage		V _{RWM}			3.3	V
Diode breakdown voltage	I _T = 1mA	V _{BR}	3.6			V
Punch-through voltage	I _{PT} = 2uA	V _{PT}	3.5			V
Snap-back voltage	I _{SB} = 50mA	V _{SB}	2.8			V
Reverse leakage current	V _{RWM} = 3.3V	I _R		0.05	0.5	uA
Clamping voltage	I _{PP} = 1 A, T _p = 8/20us	V _C		6	8	V
	I _{PP} = 5 A, T _p = 8/20us	V _C			13	V
Junction capacitance	V _R = 0 V, f = 1MHz	C _J			6	pF

RATING AND CHARACTERISTIC CURVES (CPDQC3V3C-HF)

Fig.1 - 8/20us Peak Pulse Current Waveform Acc. IEC 61000-4-5

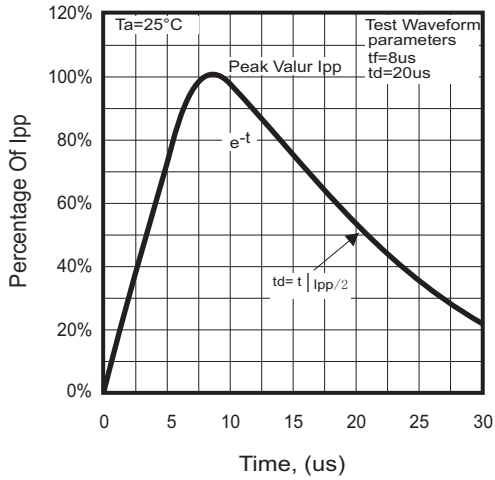

Fig.2 - Power Rating Derating Curve

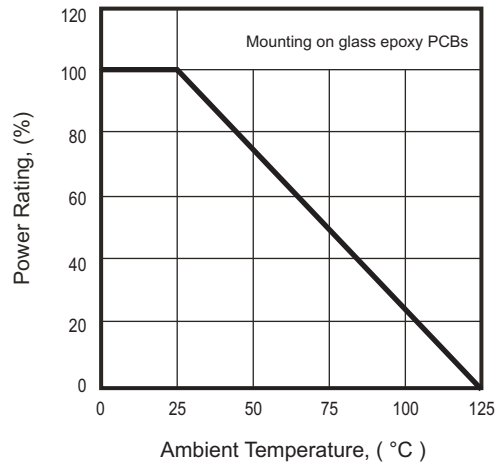

Fig.3 - Clamping Voltage Vs. Peak Pulse Current

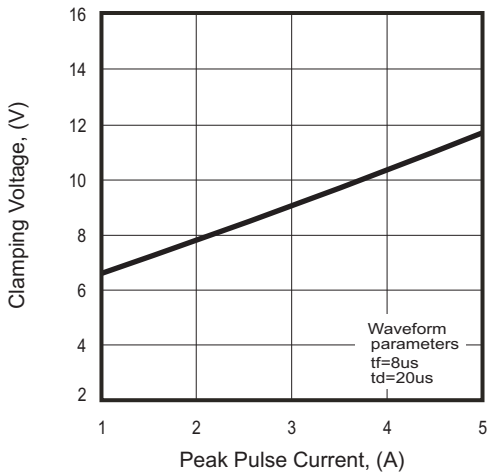
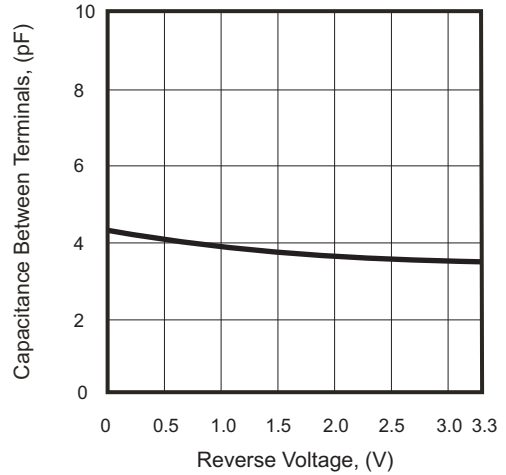
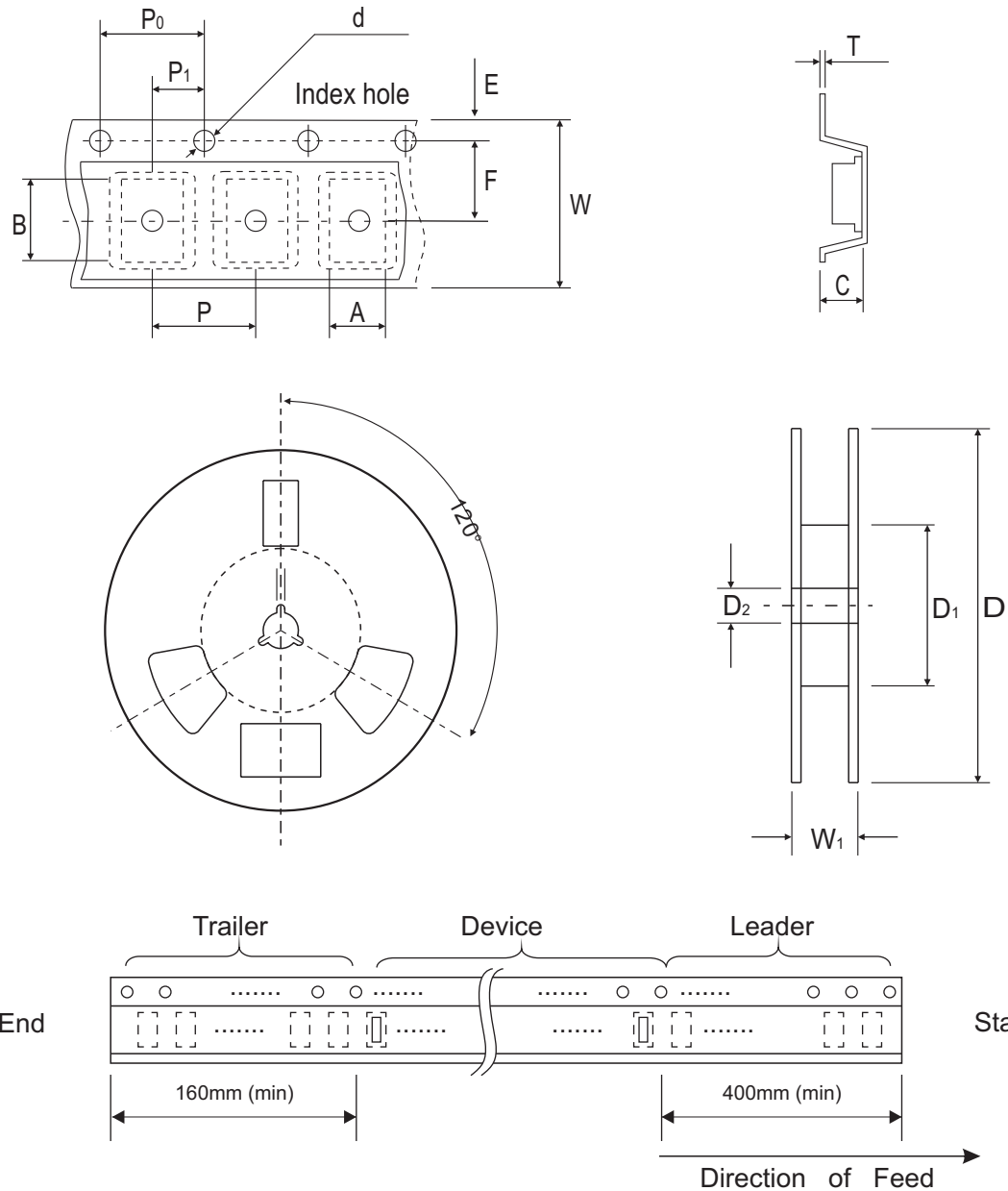

Fig.4 - Capacitance Between Terminals Characteristics



Reel Taping Specification



(5,000pcs/ Reel)

0402C (SOD-923F)	SYMBOL	A	B	C	d	D	D ₁	D ₂
	(mm)	0.75 ± 0.05	1.17 ± 0.05	0.65 ± 0.05	1.50 + 0.10 - 0	178.00 ± 1.00	60.00 ± 0.50	13.50 ± 0.20
	(inch)	0.030 ± 0.002	0.046 ± 0.002	0.026 ± 0.002	0.059 + 0.004 - 0	7.008 ± 0.039	2.362 ± 0.020	0.531 ± 0.008

0402C (SOD-923F)	SYMBOL	E	F	P	P ₀	P ₁	T	W	W ₁
	(mm)	1.75 ± 0.10	3.50 ± 0.10	4.00 ± 0.10	4.00 ± 0.10	2.00 ± 0.10	0.20 + 0.02 - 0.05	8.00 ± 0.20	12.00 + 0.50 - 0
	(inch)	0.069 ± 0.004	0.138 ± 0.004	0.157 ± 0.004	0.157 ± 0.004	0.079 ± 0.004	0.008 + 0.001 - 0.002	0.315 ± 0.008	0.472 + 0.020 - 0

Reel Taping Specification

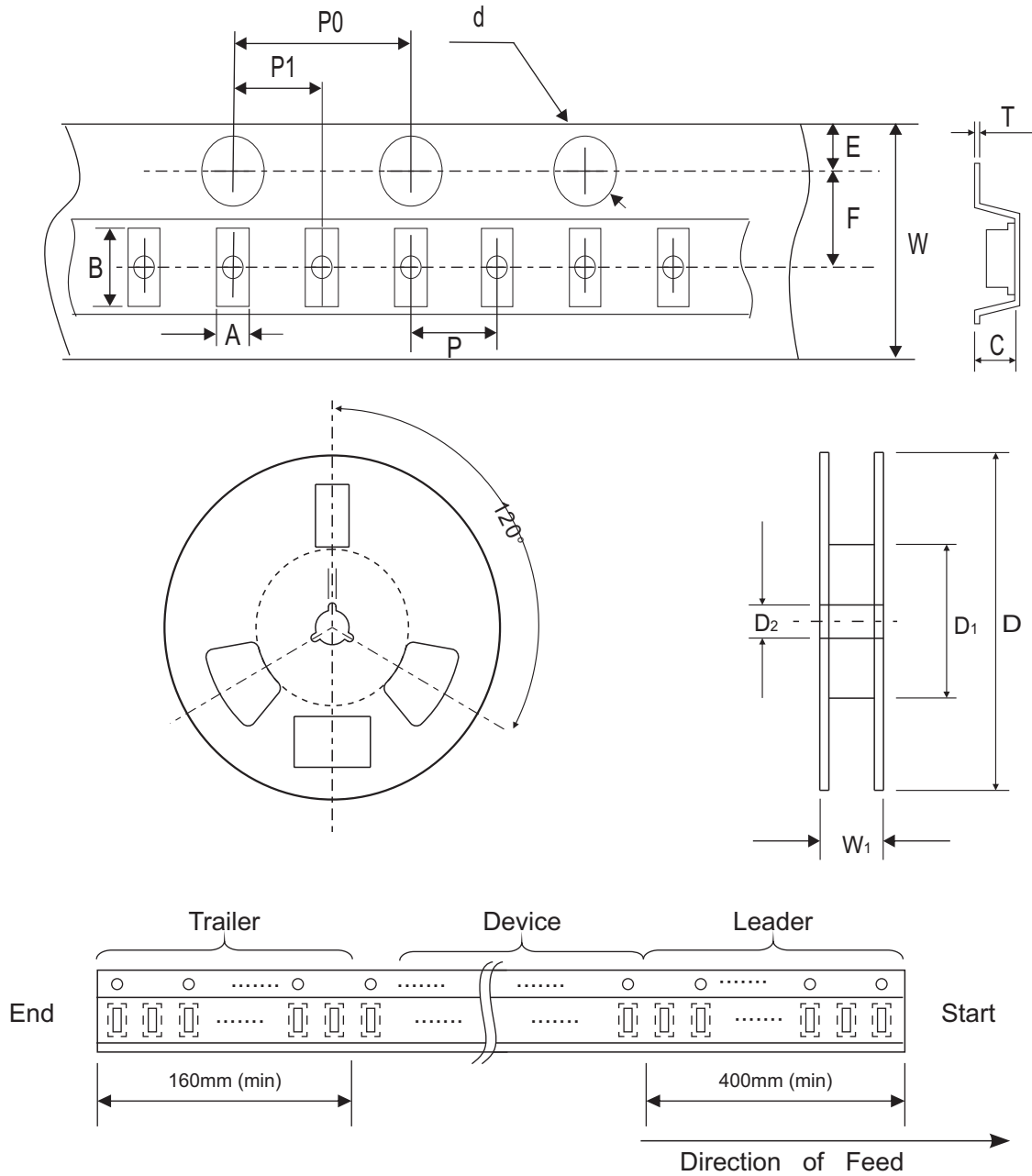

(10,000pcs/ Reel)

	SYMBOL	A	B	C	d	D	D ₁	D ₂
0402C (SOD-923F)	(mm)	0.70 ± 0.05	1.17 ± 0.05	0.60 ± 0.05	1.50 + 0.10 - 0	178.00 ± 1.00	60.00 ± 0.50	13.50 ± 0.20
	(inch)	0.028 ± 0.002	0.046 ± 0.002	0.024 ± 0.002	0.059 + 0.004 - 0	7.008 ± 0.039	2.362 ± 0.020	0.531 ± 0.008

	SYMBOL	E	F	P	P ₀	P ₁	T	W	W ₁
0402C (SOD-923F)	(mm)	1.75 ± 0.10	3.50 ± 0.05	2.00 ± 0.10	4.00 ± 0.10	2.00 ± 0.05	0.20 ± 0.05	8.00 ± 0.20	12.00 + 0.50 - 0
	(inch)	0.069 ± 0.004	0.138 ± 0.002	0.079 ± 0.004	0.157 ± 0.004	0.079 ± 0.002	0.008 + 0.002	0.315 ± 0.008	0.472 + 0.020 - 0

Company reserves the right to improve product design , functions and reliability without notice.

REV:D

Marking Code

Part Number	Marking Code	Packaging
CPDQC3V3C-HF	E3	5,000pcs/Reel
CPDQC3V3C-HFT	E3	10,000pcs/Reel

E3

Suggested PAD Layout

SIZE	0402C/SOD-923F	
	(mm)	(inch)
A	0.70	0.028
B	0.40	0.016
C	0.60	0.024
D	1.10	0.043
E	0.30	0.012

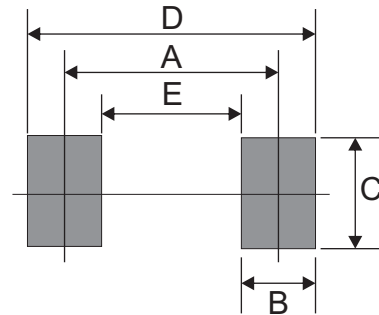

Standard Packaging

Case Type	REEL PACK	
	REEL (pcs)	Reel Size (inch)
0402C/SOD-923F	5,000	7
	10,000	7