

Features

Regulated Converter

- Wide input range 85-264VAC
- Standby mode optimized PSU (ENER Lot 6)
- Ultra-high efficiency over entire load range
- Operating temperature range: -40°C to +80°C
- Class II installations (without FG)
- EMC compliant without external components
- No load power consumption < 75mW



RAC20-K

20 Watt Single Output



IEC62368-1 pending
 EN62368-1 certified
 UL62368-1 certified
 CAN/CSA-C22.2 No. 62368-1-14 certified
 EN/IEC60335 pending
 CB Report pending

Description

The RAC20-K series are highly efficient PCB-mount power conversion modules with ultra-low energy losses especially in light load conditions, making them a benchmark for always-on and standby mode operations, which are typically coming along with IoT and smart applications. The power supply units cover worldwide mains input range of 85VAC up to 264VAC and come with international safety certifications for industrial, AV and ITE as well as household standards. These AC/DC modules operate in a temperature range of -40°C to +80°C and offer fully protected single or dual outputs as well as EMC class B compliance without the need of any external components.

Selection Guide

Part Number	Input Voltage Range [VAC]	Output Voltage [VDC]	Output Current [mA]	Efficiency typ ⁽¹⁾ [%]	Max. Capacitive Load ⁽²⁾ [µF]
RAC20-05SK ⁽³⁾	85-264	5	4000	84	10000

Notes:

Note1: Efficiency is tested at 230VAC input and constant resistive load at +25°C ambient
 Note2: Max Cap Load is tested at nominal input and full resistive load

Model Numbering

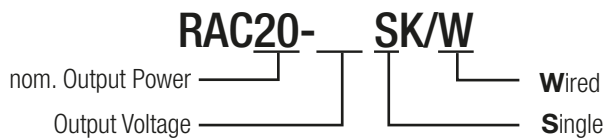

Notes:

Note3: Add suffix „W“ for wired version (available from Sept/2018) without suffix, standard THT version

Ordering Examples:

RAC20-05SK	5Vout	Single Output	standard THT version	
RAC20-05SK/W	5Vout	Single Output	wired version	(available from Sept/2018)

Specifications (measured @ Ta= 25°C, nom. Vin, full load and after warm-up unless otherwise stated)

BASIC CHARACTERISTICS

Parameter	Condition	Min.	Typ.	Max.
Internal Input Filter				Pi type
Input Voltage Range ^(4, 5)	nom. Vin= 230VAC	85VAC 120VDC	230VAC	264VAC 370VDC
Input Current	115VAC 230VAC			0.45A 0.40A
Inrush Current	cold start at +25°C	115VAC 230VAC		20A 40A
No load Power Consumption	230VAC		40mW	
ErP Lot 6 Standby Mode Conformity (Output Load Capability)	Input Power	0.5W 1.0W 2.0W		0.3W 0.7W 1.6W
Input Frequency Range	AC Input	47Hz		63Hz
Minimum Load		0%		
Power Factor	115VAC 230VAC	0.6 0.5		
Start-up Time			150ms	
Rise Time			40ms	
Hold-up Time	115VAC 230VAC		15ms 90ms	
Internal Operating Frequency				100kHz
Output Ripple and Noise ⁽⁶⁾	20MHz BW		100mVp-p	

Notes:

Note4: The products were submitted for safety files at AC-Input operation

Note5: Refer to line derating graph on page 4

Note6: Measurements are made with a 1.0µF MLCC across output (low ESR)

Efficiency vs. Load

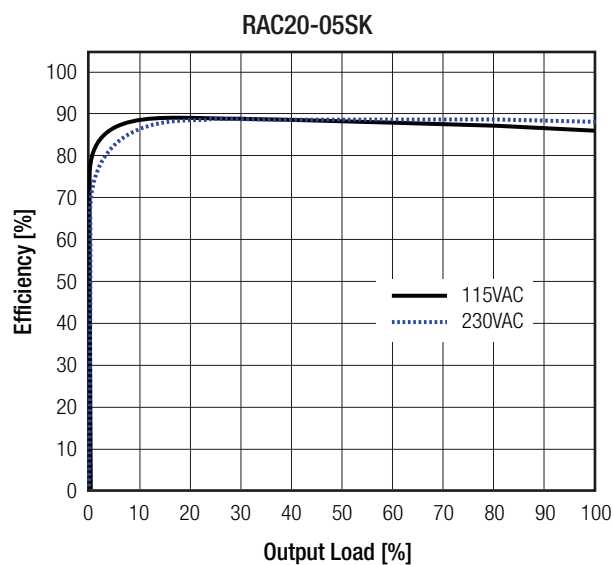

Specifications (measured @ Ta= 25°C, nom. Vin, full load and after warm-up unless otherwise stated)

REGULATIONS		
Parameter	Condition	Value
Output Accuracy		±2.0% typ.
Line Regulation		±0.5% typ.
Load Regulation	10% to 100% load	2.0% typ.
Transient Response	25% load step change recovery time	4.0% max. 500µs typ.

Deviation vs. Load

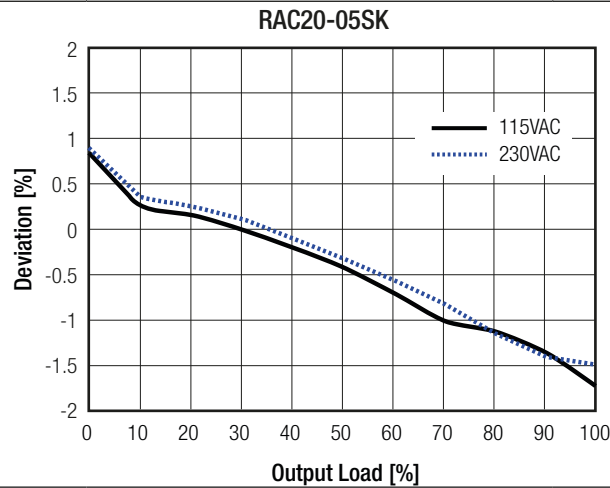

PROTECTIONS		
Parameter	Type	Value
Input Fuse ⁽⁷⁾	internal	T3.15A, slow blow type
Short Circuit Protection (SCP)	below 100mΩ	hiccup, auto recovery
Over Voltage Protection (OVP)		150% - 195%, latch off mode
Over Current Protection (OCP)		110% - 130%, latch off mode
Over Voltage Category		OVCII
Class of Equipment		Class II
Isolation Voltage ⁽⁸⁾	I/P to O/P	tested for 1 minute
Isolation Resistance		Isolation Voltage 500VDC
Isolation Capacitance	100kHz/0.1V	100pF max.
Insulation Grade		reinforced
Leakage Current		0.25mA max.

Notes:

- Note7: Refer to local wiring regulations if input over-current protection is also required
- Note8: For repeat Hi-Pot testing, reduce the time and/or the test voltage

ENVIRONMENTAL		
Parameter	Condition	Value
Operating Temperature Range	@ natural convection 0.1m/s	full load
		refer to derating graph
Maximum Case Temperature	230VAC	+95°C
Temperature Coefficient		0.05%/K
Operating Altitude		3000m
Operating Humidity	non-condensing	20% - 90% RH max.
Pollution Degree		PD2

continued on next page

Specifications (measured @ Ta= 25°C, nom. Vin, full load and after warm-up unless otherwise stated)

Parameter	Condition	Value
Vibration	according to MIL-STD-202G	10-500Hz, 2G 10min./1cycle, period 60min. along x,y,z axes
Design Lifetime	+25°C	130 x 10 ³ hours
	+55°C	16 x 10 ³ hours
MTBF	according to MIL-HDBK-217F, G.B.	>450 x 10 ³ hours

Derating Graph

(@ Chamber and natural convection 0.1 m/s)

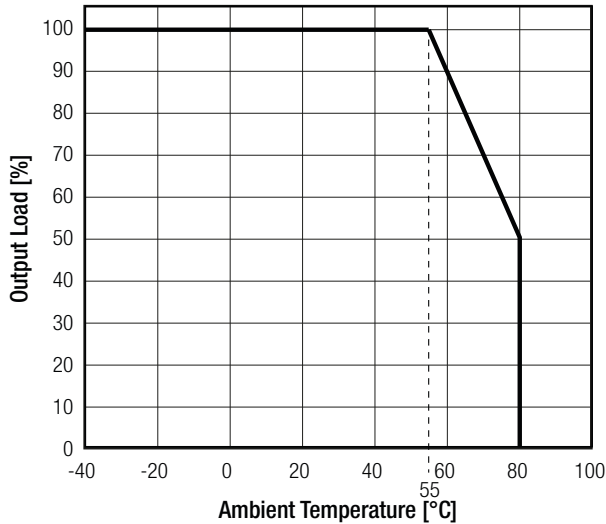

Line Derating

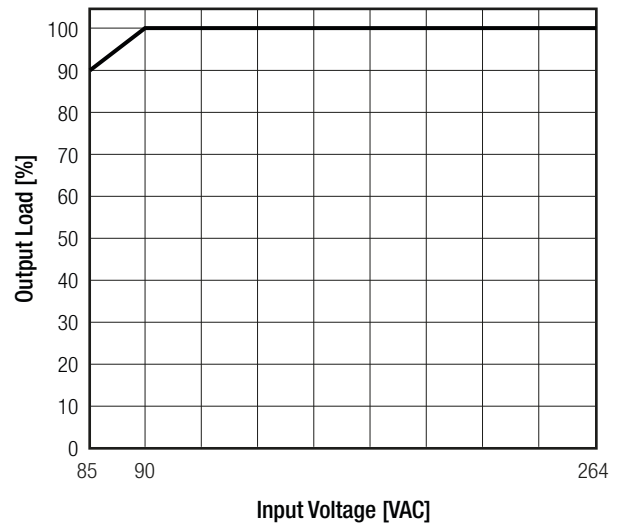

SAFETY AND CERTIFICATIONS

Certificate Type (Safety)	Report / File Number	Standard
Audio/Video, information and communication technology equipment - Safety requirements	E224736	UL62368-1, 2nd Edition, 2014 CAN/CSA C22.2 Nr. 62368-1-14, 2nd Ed. 2014
Audio/Video, information and communication technology equipment - Safety requirements (CB)	pending	IEC/EN62368-1, 2nd Edition, 2014
Audio/Video, information and communication technology equipment - Safety requirements (LVD)	E491408-A6002-CB-1	EN62368-1, 2nd Edition, 2014 + A11:2017
Household and similar electrical appliances – Safety – Part 1: General requirements	pending	EN/IEC60335-1:2012+A11:2014
RoHS 2		RoHS-2011/65/EU

EMC Compliance	Condition	Standard / Criterion
Low voltage power supplies, d.c. output Part 3: Electromagnetic compatibility (EMC)		EN61204-3:2000, Class B
Electromagnetic compatibility of multimedia equipment - Emission requirements		EN55032:2015, Class B
Electromagnetic compatibility of household appliances, electric tools and similar apparatus - Emission Requirements		EN55014-2:2015 + 1:2017
Information technology equipment - Immunity characters - Limits and methods of measurement		EN55024:2010 + A1:2015
ESD Electrostatic discharge immunity test	Contact: ±4.0kV	EN61000-4-2:2009, Criteria B
Radiated, radio-frequency, electromagnetic field immunity test		EN61000-4-3:2006 + A2:2010, Criteria B
Fast Transient and Burst Immunity	AC In Port: ±1.0kV	EN61000-4-4, Criteria B
Surge Immunity	AC In Port: L-N ±1.0kV	EN61000-4-5:2014, Criteria B
Immunity to conducted disturbances, induced by radio-frequency fields	AC Power Port: 3V	EN61000-4-6:2014, Criteria A
Power Magnetic Field Immunity		EN61000-4-8:2010, Criteria A
Voltage Dips and Interruptions	Voltage Dips 30% Voltage Dips 60% Voltage Interruptions > 95%	EN61000-4-11:2004, Criteria C EN61000-4-11:2004, Criteria C EN61000-4-11:2004, Criteria C
Limits of Voltage Fluctuations & Flicker		EN61000-3-3:2013

Specifications (measured @ Ta= 25°C, nom. Vin, full load and after warm-up unless otherwise stated)

DIMENSION AND PHYSICAL CHARACTERISTICS

Parameter	Type	Value
Material	case	black plastic, (UL94V-0)
	potting	silicone, (UL94V-0)
	PCB	FR4, (UL94V-0)
	baseplate	plastic, (UL94V-0)
Dimension (LxWxH)	THT/wired	52.5 x 27.4 x 23.0mm
Weight	THT wired	60g typ. 65g typ.

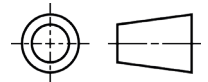

Dimension Drawing (mm)

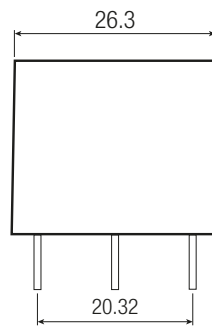
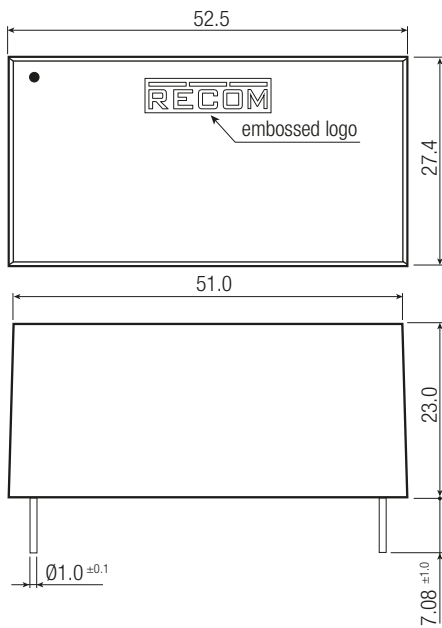

Pinning information

Pin #	Single
1	VAC in (N)
2	VAC in (L)
4	-Vout
5	+Vout

NC= no connection
FX= fixing centers
Tolerance: xx.x= ±0.5mm
xx.xx= ±0.25mm

Recommended Footprint Details

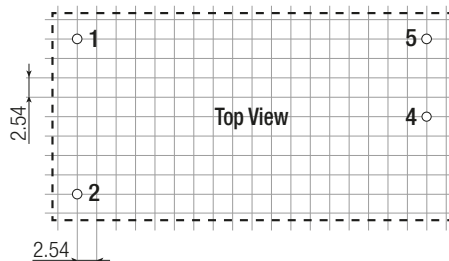
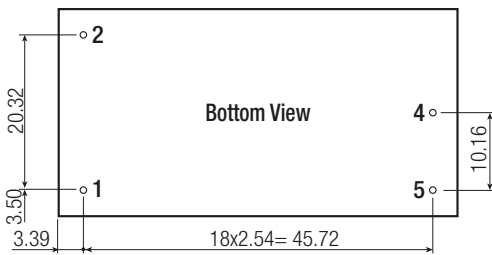

continued on next page

Specifications (measured @ Ta= 25°C, nom. Vin, full load and after warm-up unless otherwise stated)

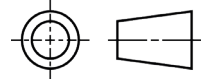

Dimension Drawing Single Wired (mm) (available from Sept/2018)

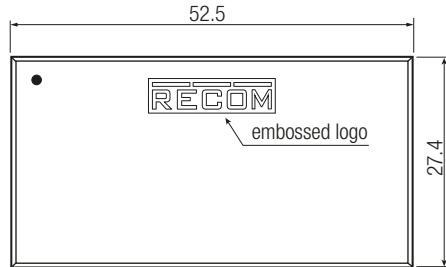

Wired information

#	Function	Wire color	Type	AWG
1	VAC in (N)	blue	UL-1015	18
2	VAC in (L)	brown	UL-1015	18
4	-Vout	red	UL-1015	18
5	+Vout	black	UL-1015	18

Tolerance: xx.x= ±0.5mm
xx.xx= ±0.25mm

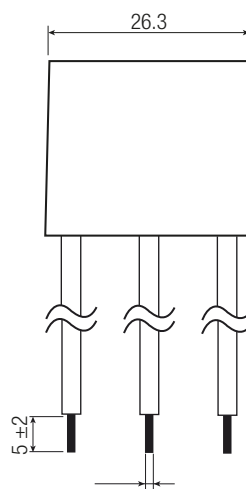
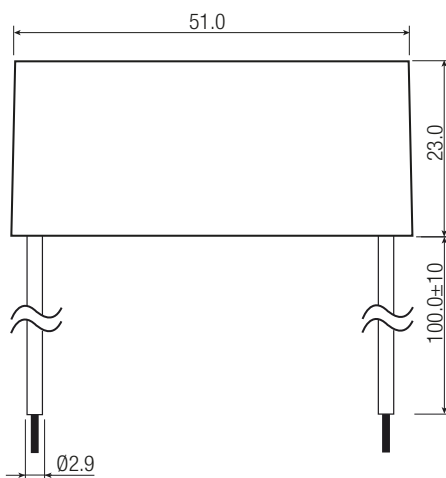

Recommended Footprint Details

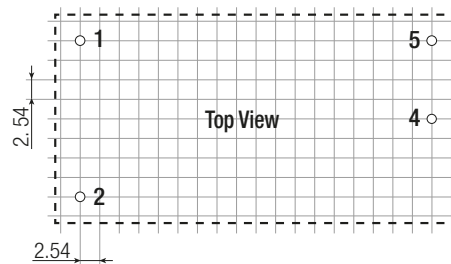
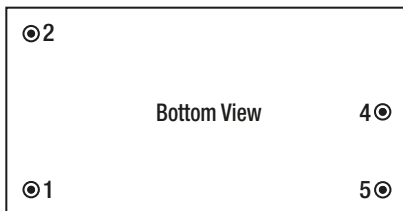

PACKAGING INFORMATION

Parameter	Type		Value
	THT wired	tube tray	
Packaging Dimension (LxWxH)			490.0 x 56.0 x 40.0mm 488.0 x 202.0 x 47.0mm
Packaging Quantity	THT wired		15pcs 20pcs
Storage Temperature Range			-40°C to +85°C
Storage Humidity	non-condensing		20% to 90% RH max.

The product information and specifications may be subject to changes even without prior written notice. The product has been designed for various applications; its suitability lies in the responsibility of each customer. The products are not authorized for use in safety-critical applications without RECOM's explicit written consent. A safety-critical application is an application where a failure may reasonably be expected to endanger or cause loss of life, inflict bodily harm or damage property. The applicant shall indemnify and hold harmless RECOM, its affiliated companies and its representatives against any damage claims in connection with the unauthorized use of RECOM products in such safety-critical applications.