

NLSX4401

1-Bit 20 Mb/s Dual-Supply Level Translator

The NLSX4401 is a 1-bit configurable dual-supply bidirectional auto sensing translator that does not require a directional control pin. The I/O V_{CC} and I/O V_L ports are designed to track two different power supply rails, V_{CC} and V_L respectively. Both the V_{CC} and V_L supply rails are configurable from 1.5 V to 5.5 V. This allows voltage logic signals on the V_L side to be translated into lower, higher or equal value voltage logic signals on the V_{CC} side, and vice-versa.

The NLSX4401 translator has integrated 10 k Ω pull-up resistors on the I/O lines. The integrated pull-up resistors are used to pull up the I/O lines to either V_L or V_{CC} . The NLSX4401 is an excellent match for open-drain applications such as the I²C communication bus.

Features

- V_L can be Less than, Greater than or Equal to V_{CC}
- Wide V_{CC} Operating Range: 1.5 V to 5.5 V
Wide V_L Operating Range: 1.5 V to 5.5 V
- High Speed with 24 Mb/s Guaranteed Data Rate
- Low Bit-to-Bit Skew
- Enable Input and I/O Pins are Overvoltage Tolerant (OVT) to 5.5 V
- Non-preferential Powerup Sequencing
- Power-Off Protection
- Integrated 10 k Ω Pull-up Resistors
- Small Space Saving Package:
1.45 mm x 1.0 mm UDFN6 Package
- These Devices are Pb-Free and are RoHS Compliant

Typical Applications

- I²C, SMBus, PMBus
- Low Voltage ASIC Level Translation
- Mobile Phones, PDAs, Cameras

Important Information

- ESD Protection for All Pins
 - Human Body Model (HBM) > 5000 V



ON Semiconductor®

<http://onsemi.com>

MARKING DIAGRAMS



UDFN6
1.45 x 1.0
CASE 517AQ



Y = Specific Device Code
(Rotated 270° clockwise)
M = Date Code

LOGIC DIAGRAM

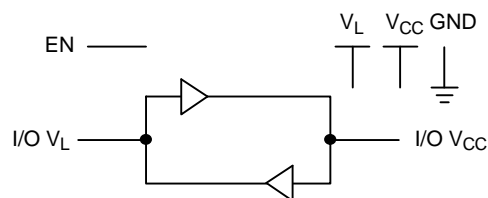

ORDERING INFORMATION

Device	Package	Shipping†
NLSX4401MU1TCG	UDFN6 (Pb-Free)	3000 / Tape & Reel

†For information on tape and reel specifications, including part orientation and tape sizes, please refer to our Tape and Reel Packaging Specification Brochure, BRD8011/D.

NLSX4401

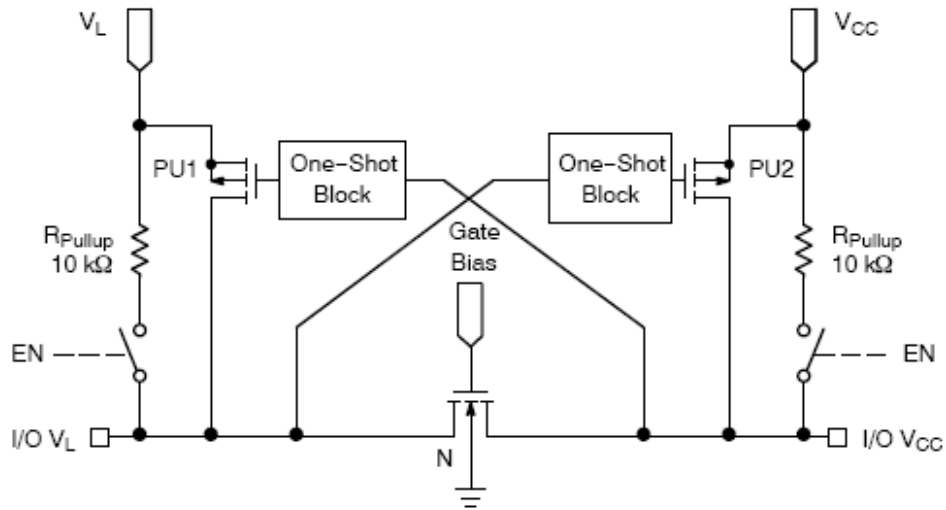
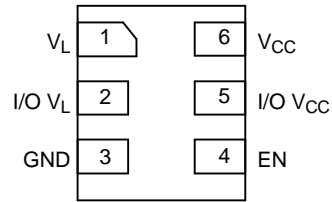

Figure 1. Block Diagram (1 I/O Line)



UDFN6
(Top Through View)

Figure 2. Pinout Diagram

PIN ASSIGNMENT

Pins	Description
V _{CC}	V _{CC} Supply Voltage
V _L	V _L Supply Voltage
GND	Ground
EN	Output Enable, Referenced to V _L
I/O V _{CC}	I/O Port, Referenced to V _{CC}
I/O V _L	I/O Port, Referenced to V _L

FUNCTION TABLE

EN	Operating Mode
L	Hi-Z
H	I/O Buses Connected

NLSX4401

MAXIMUM RATINGS

Symbol	Parameter	Value	Condition	Unit
V _{CC}	High-side DC Supply Voltage	-0.5 to +7.0		V
V _L	High-side DC Supply Voltage	-0.5 to +7.0		V
I/O V _{CC}	V _{CC} -Referenced DC Input/Output Voltage	-0.5 to +7.0		V
I/O V _L	V _L -Referenced DC Input/Output Voltage	-0.5 to +7.0		V
V _{EN}	Enable Control Pin DC Input Voltage	-0.5 to +7.0		V
I _{I/O_SC}	Short-Circuit Duration (I/O V _L and I/O V _{CC} to GND)	±50	Continuous	mA
I _{I/O_K}	Input/Output Clamping Current (I/O V _L and I/O V _{CC})	-50	V _{I/O} < 0	mA
T _{STG}	Storage Temperature	-65 to +150		°C

Stresses exceeding those listed in the Maximum Ratings table may damage the device. If any of these limits are exceeded, device functionality should not be assumed, damage may occur and reliability may be affected.

RECOMMENDED OPERATING CONDITIONS

Symbol	Parameter	Min	Max	Unit
V _{CC}	High-side Positive DC Supply Voltage	1.5	5.5	V
V _L	High-side Positive DC Supply Voltage	1.5	5.5	V
V _{EN}	Enable Control Pin Voltage	GND	5.5	V
V _{IO_VCC}	I/O Pin Voltage (Side referred to V _{CC})	GND	5.5	V
V _{IO_VL}	I/O Pin Voltage (Side referred to V _L)	GND	5.5	V
Δt/ΔV	Input Transition Rise and Fall Rate A- or B-Ports, Push-Pull Driving Control Input		10 10	ns/V
T _A	Operating Temperature Range	-55	+125	°C

Functional operation above the stresses listed in the Recommended Operating Ranges is not implied. Extended exposure to stresses beyond the Recommended Operating Ranges limits may affect device reliability.

NLSX4401

DC ELECTRICAL CHARACTERISTICS ($V_L = 1.5\text{ V to }5.5\text{ V}$ and $V_{CC} = 1.5\text{ V to }5.5\text{ V}$, unless otherwise specified) (Note 1)

Symbol	Parameter	Test Conditions (Note 2)	-55°C to +125°C			Unit
			Min	Typ	Max	
V_{IHC}	I/O V_{CC} Input HIGH Voltage		$V_{CC} - 0.4$	-	-	V
V_{ILC}	I/O V_{CC} Input LOW Voltage		-	-	0.15	V
V_{IHL}	I/O V_L Input HIGH Voltage		$V_L - 0.4$	-	-	V
V_{ILL}	I/O V_L Input LOW Voltage		-	-	0.15	V
V_{IH}	Control Pin Input HIGH Voltage		$0.65 * V_L$	-	-	V
V_{IL}	Control Pin Input LOW Voltage		-	-	$0.35 * V_L$	V
V_{OHC}	I/O V_{CC} Output HIGH Voltage	I/O V_{CC} source current = 20 μA	$2/3 * V_{CC}$	-	-	V
V_{OLC}	I/O V_{CC} Output LOW Voltage	I/O V_{CC} sink current = 1 mA	-	-	0.4	V
V_{OHL}	I/O V_L Output HIGH Voltage	I/O V_L source current = 20 μA	$2/3 * V_L$	-	-	V
V_{OLL}	I/O V_L Output LOW Voltage	I/O V_L sink current = 1 mA	-	-	0.4	V
I_{QVCC}	V_{CC} Supply Current Supply Current	I/O V_{CC} and I/O V_L unconnected, $V_{EN} = V_L$	-	0.5	2.0	μA
		$V_L = 5.5\text{ V}$, $V_{CC} = 0\text{ V}$	-	-	1.0	
		$V_L = 0\text{ V}$, $V_{CC} = 5.5\text{ V}$	-	-	-1.0	
I_{QVL}	V_L Supply Current Supply Current	I/O V_{CC} and I/O V_L unconnected, $V_{EN} = V_L$	-	0.3	1.5	μA
		$V_L = 5.5\text{ V}$, $V_{CC} = 0\text{ V}$	-	-	-1.0	
		$V_L = 0\text{ V}$, $V_{CC} = 5.5\text{ V}$	-	-	1.0	
I_{TS-VCC}	V_{CC} Tristate Output Mode	I/O V_{CC} and I/O V_L unconnected, $V_{EN} = \text{GND}$	-	0.1	1.0	μA
I_{TS-VL}	V_L Tristate Output Mode Supply Current	I/O V_{CC} and I/O V_L unconnected, $V_{EN} = \text{GND}$	-	0.1	1.0	μA
I_I	Enable Pin Input Leakage Current		-	-	1.0	μA
I_{OFF}	I/O Power-Off Leakage Current	I/O V_{CC} Port, $V_{CC} = 0\text{ V}$, $V_L = 0\text{ to }5.5\text{ V}$	-	-	1.0	μA
		I/O V_L Port, $V_{CC} = 0\text{ to }5.5\text{ V}$, $V_L = 0\text{ V}$	-	-	1.0	
I_{OZ}	I/O Tristate Output Mode Leakage Current		-	0.1	1.0	μA
R_{PU}	Pull-Up Resistors I/O V_L and V_C		-	10	-	$\text{k}\Omega$

Product parametric performance is indicated in the Electrical Characteristics for the listed test conditions, unless otherwise noted. Product performance may not be indicated by the Electrical Characteristics if operated under different conditions.

1. Typical values are for $V_L = +1.8\text{ V}$, $V_{CC} = +3.3\text{ V}$ and $T_A = +25^\circ\text{C}$.

2. All units are production tested at $T_A = +25^\circ\text{C}$. Limits over the operating temperature range are guaranteed by design.

NLSX4401

TIMING CHARACTERISTICS – RAIL-TO-RAIL DRIVING CONFIGURATIONS

(I/O test circuit of Figures 3 and 4, $C_{LOAD} = 15 \text{ pF}$, driver output impedance $\leq 50 \Omega$, $R_{LOAD} = 1 \text{ M}\Omega$)

Symbol	Parameter	Test Conditions	-40°C to +85°C (Notes 3 & 4)			Unit
			Min	Typ	Max	

$V_L = 1.5 \text{ V}$, $V_{CC} = 1.5 \text{ V}$

t_{RVCC}	I/O V_{CC} Rise Time			9	32	ns
t_{FVCC}	I/O V_{CC} Fall Time			11	20	ns
t_{RVL}	I/O V_L Rise Time			20	30	ns
t_{FVL}	I/O V_L Fall Time			10	13	ns
$t_{PDVL-VCC}$	Propagation Delay (Driving I/O V_L , V_L to V_{CC})			7	16	ns
$t_{PDVCC-VL}$	Propagation Delay (Driving I/O V_{CC} , V_{CC} to V_L)			12	15	ns
t_{EN}	Enable Time				50	ns
t_{DIS}	Disable Time				300	ns
t_{PPSKEW}	Part-to-Part Skew				2	ns
MDR	Maximum Data Rate		15			Mbps

$V_L = 1.5 \text{ V}$, $V_{CC} = 5.5 \text{ V}$

t_{RVCC}	I/O V_{CC} Rise Time			9	12	ns
t_{FVCC}	I/O V_{CC} Fall Time			17	30	ns
t_{RVL}	I/O V_L Rise Time			2	4	ns
t_{FVL}	I/O V_L Fall Time			3	7	ns
$t_{PDVL-VCC}$	Propagation Delay (Driving I/O V_L , V_L to V_{CC})			14	24	ns
$t_{PDVCC-VL}$	Propagation Delay (Driving I/O V_{CC} , V_{CC} to V_L)			3	5	ns
t_{EN}	Enable Time				40	ns
t_{DIS}	Disable Time				250	ns
t_{PPSKEW}	Part-to-Part Skew				2	ns
MDR	Maximum Data Rate		20			Mbps

$V_L = 1.8 \text{ V}$, $V_{CC} = 2.8 \text{ V}$

t_{RVCC}	I/O V_{CC} Rise Time			11	18	ns
t_{FVCC}	I/O V_{CC} Fall Time			10	15	ns
t_{RVL}	I/O V_L Rise Time			12	15	ns
t_{FVL}	I/O V_L Fall Time			5	8	ns
$t_{PDVL-VCC}$	Propagation Delay (Driving I/O V_L , V_L to V_{CC})			7	10	ns
$t_{PDVCC-VL}$	Propagation Delay (Driving I/O V_{CC} , V_{CC} to V_L)			5	9	ns
t_{EN}	Enable Time				50	ns
t_{DIS}	Disable Time				300	ns
t_{PPSKEW}	Part-to-Part Skew				2	ns
MDR	Maximum Data Rate		20			Mbps

$V_L = 2.5 \text{ V}$, $V_{CC} = 3.6 \text{ V}$

t_{RVCC}	I/O V_{CC} Rise Time			8	12	ns
------------	------------------------	--	--	---	----	----

Product parametric performance is indicated in the Electrical Characteristics for the listed test conditions, unless otherwise noted. Product performance may not be indicated by the Electrical Characteristics if operated under different conditions.

3. Typical values are for the specified V_L and V_{CC} at $T_A = +25^\circ\text{C}$. All units are production tested at $T_A = +25^\circ\text{C}$.

4. Limits over the operating temperature range are guaranteed by design.

5. Skew is the variation of propagation delay between output signals and applies only to output signals on the same port (I/O_VLn or I/O_VCCn) and switching with the same polarity (LOW-to-HIGH or HIGH-to-LOW). Skew is defined by applying a single input to the two input channels and measuring the difference in propagation delays between the output channels.

NLSX4401

TIMING CHARACTERISTICS – RAIL-TO-RAIL DRIVING CONFIGURATIONS (continued)

(I/O test circuit of Figures 3 and 4, $C_{LOAD} = 15 \text{ pF}$, driver output impedance $\leq 50 \Omega$, $R_{LOAD} = 1 \text{ M}\Omega$)

Symbol	Parameter	Test Conditions	-40°C to +85°C (Notes 3 & 4)			Unit
			Min	Typ	Max	

$V_L = 2.5 \text{ V}$, $V_{CC} = 3.6 \text{ V}$

t_{FVCC}	I/O V_{CC} Fall Time			8	12	ns
t_{RVL}	I/O V_L Rise Time			7	10	ns
t_{FVL}	I/O V_L Fall Time			5	7	ns
$t_{PDVL-VCC}$	Propagation Delay (Driving I/O V_L , V_L to V_{CC})			7	10	ns
$t_{PDVCC-VL}$	Propagation Delay (Driving I/O V_{CC} , V_{CC} to V_L)			5	8	ns
t_{EN}	Enable Time				40	ns
t_{DIS}	Disable Time				225	ns
t_{PPSKEW}	Part-to-Part Skew				2	ns
MDR	Maximum Data Rate		24			Mbps

$V_L = 2.8 \text{ V}$, $V_{CC} = 1.8 \text{ V}$

t_{RVCC}	I/O V_{CC} Rise Time			13	20	ns
t_{FVCC}	I/O V_{CC} Fall Time			7	10	ns
t_{RVL}	I/O V_L Rise Time			8	13	ns
t_{FVL}	I/O V_L Fall Time			9	15	ns
$t_{PDVL-VCC}$	Propagation Delay (Driving I/O V_L , V_L to V_{CC})			6	9	ns
$t_{PDVCC-VL}$	Propagation Delay (Driving I/O V_{CC} , V_{CC} to V_L)			7	12	ns
t_{EN}	Enable Time				60	ns
t_{DIS}	Disable Time				250	ns
t_{PPSKEW}	Part-to-Part Skew				2	ns
MDR	Maximum Data Rate		24			Mbps

$V_L = 3.6 \text{ V}$, $V_{CC} = 2.5 \text{ V}$

t_{RVCC}	I/O V_{CC} Rise Time			9	12	ns
t_{FVCC}	I/O V_{CC} Fall Time			6	9	ns
t_{RVL}	I/O V_L Rise Time			6	12	ns
t_{FVL}	I/O V_L Fall Time			7	12	ns
$t_{PDVL-VCC}$	Propagation Delay (Driving I/O V_L , V_L to V_{CC})			5	7	ns
$t_{PDVCC-VL}$	Propagation Delay (Driving I/O V_{CC} , V_{CC} to V_L)			6	9	ns
t_{EN}	Enable Time				50	ns
t_{DIS}	Disable Time				250	ns
t_{PPSKEW}	Part-to-Part Skew				2	ns
MDR	Maximum Data Rate		24			Mbps

$V_L = 5.5 \text{ V}$, $V_{CC} = 1.5 \text{ V}$

t_{RVCC}	I/O V_{CC} Rise Time			13	20	ns
t_{FVCC}	I/O V_{CC} Fall Time			6	9	ns

Product parametric performance is indicated in the Electrical Characteristics for the listed test conditions, unless otherwise noted. Product performance may not be indicated by the Electrical Characteristics if operated under different conditions.

3. Typical values are for the specified V_L and V_{CC} at $T_A = +25^\circ\text{C}$. All units are production tested at $T_A = +25^\circ\text{C}$.

4. Limits over the operating temperature range are guaranteed by design.

5. Skew is the variation of propagation delay between output signals and applies only to output signals on the same port (I/O_VLn or I/O_VCCn) and switching with the same polarity (LOW-to-HIGH or HIGH-to-LOW). Skew is defined by applying a single input to the two input channels and measuring the difference in propagation delays between the output channels.

NLSX4401

TIMING CHARACTERISTICS – RAIL-TO-RAIL DRIVING CONFIGURATIONS (continued)

(I/O test circuit of Figures 3 and 4, $C_{LOAD} = 15 \text{ pF}$, driver output impedance $\leq 50 \Omega$, $R_{LOAD} = 1 \text{ M}\Omega$)

Symbol	Parameter	Test Conditions	-40°C to +85°C (Notes 3 & 4)			Unit
			Min	Typ	Max	
$V_L = 5.5 \text{ V}$, $V_{CC} = 1.5 \text{ V}$						
t_{RVL}	I/O V_L Rise Time			8	10	ns
t_{FVL}	I/O V_L Fall Time			20	27	ns
$t_{PDVL-VCC}$	Propagation Delay (Driving I/O V_L , V_L to V_{CC})			5	8	ns
$t_{PDVCC-VL}$	Propagation Delay (Driving I/O V_{CC} , V_{CC} to V_L)			14	24	ns
t_{EN}	Enable Time					ns
t_{DIS}	Disable Time					ns
t_{PPSKEW}	Part-to-Part Skew				2	ns
MDR	Maximum Data Rate		20			Mbps

$V_L = 5.5 \text{ V}$, $V_{CC} = 5.5 \text{ V}$

t_{RVCC}	I/O V_{CC} Rise Time			5	7	ns
t_{FVCC}	I/O V_{CC} Fall Time			6	8	ns
t_{RVL}	I/O V_L Rise Time			5	7	ns
t_{FVL}	I/O V_L Fall Time			4	7	ns
$t_{PDVL-VCC}$	Propagation Delay (Driving I/O V_L , V_L to V_{CC})			4	6	ns
$t_{PDVCC-VL}$	Propagation Delay (Driving I/O V_{CC} , V_{CC} to V_L)			4	6	ns
t_{EN}	Enable Time				30	ns
t_{DIS}	Disable Time				225	ns
t_{PPSKEW}	Part-to-Part Skew				2	ns
MDR	Maximum Data Rate		24			Mbps

Product parametric performance is indicated in the Electrical Characteristics for the listed test conditions, unless otherwise noted. Product performance may not be indicated by the Electrical Characteristics if operated under different conditions.

3. Typical values are for the specified V_L and V_{CC} at $T_A = +25^\circ\text{C}$. All units are production tested at $T_A = +25^\circ\text{C}$.

4. Limits over the operating temperature range are guaranteed by design.

5. Skew is the variation of propagation delay between output signals and applies only to output signals on the same port (I/O_VLn or I/O_VCCn) and switching with the same polarity (LOW-to-HIGH or HIGH-to-LOW). Skew is defined by applying a single input to the two input channels and measuring the difference in propagation delays between the output channels.

TIMING CHARACTERISTICS – OPEN DRAIN DRIVING CONFIGURATIONS

(I/O test circuit of Figures 5 and 6, $C_{LOAD} = 15 \text{ pF}$, driver output impedance $\leq 50 \Omega$, $R_{LOAD} = 1 \text{ M}\Omega$)

Symbol	Parameter	Test Conditions	-40°C to +85°C (Notes 6 & 7)			Unit
			Min	Typ	Max	

$V_L = 1.5 \text{ V}$, $V_{CC} = 1.5 \text{ V}$

t_{RVCC}	I/O V_{CC} Rise Time			55	70	ns
t_{FVCC}	I/O V_{CC} Fall Time			7	14	ns
t_{RVL}	I/O V_L Rise Time			50	65	ns
t_{FVL}	I/O V_L Fall Time			7	12	ns

Product parametric performance is indicated in the Electrical Characteristics for the listed test conditions, unless otherwise noted. Product performance may not be indicated by the Electrical Characteristics if operated under different conditions.

6. Typical values are for the specified V_L and V_{CC} at $T_A = +25^\circ\text{C}$. All units are production tested at $T_A = +25^\circ\text{C}$.

7. Limits over the operating temperature range are guaranteed by design.

8. Skew is the variation of propagation delay between output signals and applies only to output signals on the same port (I/O_VLn or I/O_VCCn) and switching with the same polarity (LOW-to-HIGH or HIGH-to-LOW). Skew is defined by applying a single input to the two input channels and measuring the difference in propagation delays between the output channels.

NLSX4401

TIMING CHARACTERISTICS – OPEN DRAIN DRIVING CONFIGURATIONS (continued)

(I/O test circuit of Figures 5 and 6, $C_{LOAD} = 15 \text{ pF}$, driver output impedance $\leq 50 \Omega$, $R_{LOAD} = 1 \text{ M}\Omega$)

Symbol	Parameter	Test Conditions	–40°C to +85°C (Notes 6 & 7)			Unit
			Min	Typ	Max	

$V_L = 1.5 \text{ V}$, $V_{CC} = 1.5 \text{ V}$

$t_{PDVL-VCC}$	Propagation Delay (Driving I/O V_L , V_L to V_{CC})			20	34	ns
$t_{PDVCC-VL}$	Propagation Delay (Driving I/O V_{CC} , V_{CC} to V_L)			19	34	ns
t_{EN}	Enable Time				100	ns
t_{DIS}	Disable Time				300	ns
t_{PPSKEW}	Part-to-Part Skew				2	ns
MDR	Maximum Data Rate		3			Mbps

$V_L = 1.5 \text{ V}$, $V_{CC} = 5.5 \text{ V}$

t_{RVCC}	I/O V_{CC} Rise Time			22	34	ns
t_{FVCC}	I/O V_{CC} Fall Time			20	27	ns
t_{RVL}	I/O V_L Rise Time			43	55	ns
t_{FVL}	I/O V_L Fall Time			6	12	ns
$t_{PDVL-VCC}$	Propagation Delay (Driving I/O V_L , V_L to V_{CC})			13	26	ns
$t_{PDVCC-VL}$	Propagation Delay (Driving I/O V_{CC} , V_{CC} to V_L)			19	24	ns
t_{EN}	Enable Time				80	ns
t_{DIS}	Disable Time				250	ns
t_{PPSKEW}	Part-to-Part Skew				2	ns
MDR	Maximum Data Rate		3			Mbps

$V_L = 1.8 \text{ V}$, $V_{CC} = 3.3 \text{ V}$

t_{RVCC}	I/O V_{CC} Rise Time			34	40	ns
t_{FVCC}	I/O V_{CC} Fall Time			1	15	ns
t_{RVL}	I/O V_L Rise Time			40	48	ns
t_{FVL}	I/O V_L Fall Time			1	2	ns
$t_{PDVL-VCC}$	Propagation Delay (Driving I/O V_L , V_L to V_{CC})			9	15	ns
$t_{PDVCC-VL}$	Propagation Delay (Driving I/O V_{CC} , V_{CC} to V_L)			6	11	ns
t_{EN}	Enable Time				70	ns
t_{DIS}	Disable Time				300	ns
t_{PPSKEW}	Part-to-Part Skew				2	ns
MDR	Maximum Data Rate		7			Mbps

$V_L = 5.5 \text{ V}$, $V_{CC} = 1.5 \text{ V}$

t_{RVCC}	I/O V_{CC} Rise Time			44	52	ns
t_{FVCC}	I/O V_{CC} Fall Time			1	2	ns
t_{RVL}	I/O V_L Rise Time			7	30	ns
t_{FVL}	I/O V_L Fall Time			17	23	ns
$t_{PDVL-VCC}$	Propagation Delay (Driving I/O V_L , V_L to V_{CC})			10	17	ns

Product parametric performance is indicated in the Electrical Characteristics for the listed test conditions, unless otherwise noted. Product performance may not be indicated by the Electrical Characteristics if operated under different conditions.

6. Typical values are for the specified V_L and V_{CC} at $T_A = +25^\circ\text{C}$. All units are production tested at $T_A = +25^\circ\text{C}$.

7. Limits over the operating temperature range are guaranteed by design.

8. Skew is the variation of propagation delay between output signals and applies only to output signals on the same port (I/O_VLn or I/O_VCCn) and switching with the same polarity (LOW-to-HIGH or HIGH-to-LOW). Skew is defined by applying a single input to the two input channels and measuring the difference in propagation delays between the output channels.

NLSX4401

TIMING CHARACTERISTICS – OPEN DRAIN DRIVING CONFIGURATIONS (continued)

(I/O test circuit of Figures 5 and 6, $C_{LOAD} = 15 \text{ pF}$, driver output impedance $\leq 50 \Omega$, $R_{LOAD} = 1 \text{ M}\Omega$)

Symbol	Parameter	Test Conditions	–40°C to +85°C (Notes 6 & 7)			Unit
			Min	Typ	Max	

$V_L = 5.5 \text{ V}$, $V_{CC} = 1.5 \text{ V}$

$t_{PDVCC-VL}$	Propagation Delay (Driving I/O V_{CC} , V_{CC} to V_L)			12	24	ns
t_{EN}	Enable Time				100	ns
t_{DIS}	Disable Time				300	ns
t_{PPSKEW}	Part-to-Part Skew				2	ns
MDR	Maximum Data Rate		3			Mbps

$V_L = 5.5 \text{ V}$, $V_{CC} = 5.5 \text{ V}$

t_{RVCC}	I/O V_{CC} Rise Time			42	50	ns
t_{FVCC}	I/O V_{CC} Fall Time			2	3	ns
t_{RVL}	I/O V_L Rise Time			44	48	ns
t_{FVL}	I/O V_L Fall Time			2	3	ns
$t_{PDVL-VCC}$	Propagation Delay (Driving I/O V_L , V_L to V_{CC})			4	6	ns
$t_{PDVCC-VL}$	Propagation Delay (Driving I/O V_{CC} , V_{CC} to V_L)			6	9	ns
t_{EN}	Enable Time				60	ns
t_{DIS}	Disable Time				225	ns
t_{PPSKEW}	Part-to-Part Skew				2	ns
MDR	Maximum Data Rate		7			Mbps

Product parametric performance is indicated in the Electrical Characteristics for the listed test conditions, unless otherwise noted. Product performance may not be indicated by the Electrical Characteristics if operated under different conditions.

6. Typical values are for the specified V_L and V_{CC} at $T_A = +25^\circ\text{C}$. All units are production tested at $T_A = +25^\circ\text{C}$.

7. Limits over the operating temperature range are guaranteed by design.

8. Skew is the variation of propagation delay between output signals and applies only to output signals on the same port (I/O_VLn or I/O_VCCn) and switching with the same polarity (LOW-to-HIGH or HIGH-to-LOW). Skew is defined by applying a single input to the two input channels and measuring the difference in propagation delays between the output channels.

NLSX4401

TEST SETUP

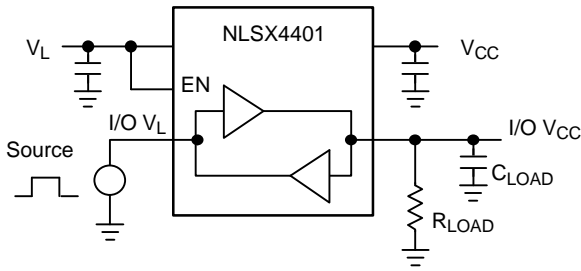

Figure 3. Rail-to-Rail Driving I/O V_L

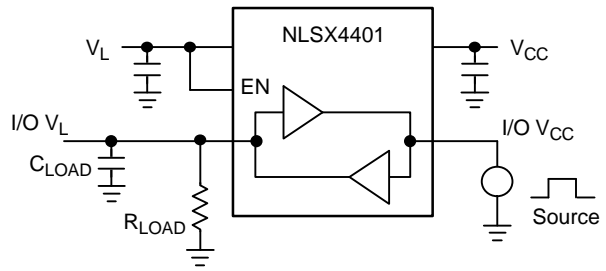

Figure 4. Rail-to-Rail Driving I/O V_{CC}

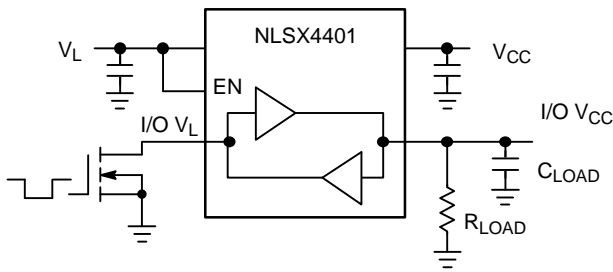

Figure 5. Open-Drain Driving I/O V_L

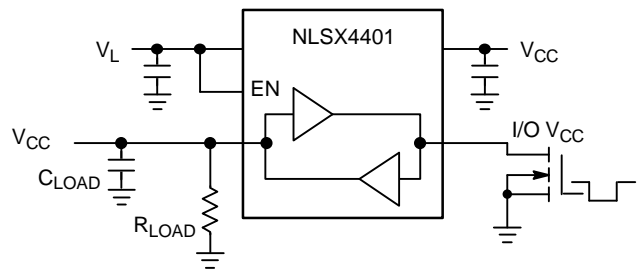

Figure 6. Open-Drain Driving I/O V_{CC}

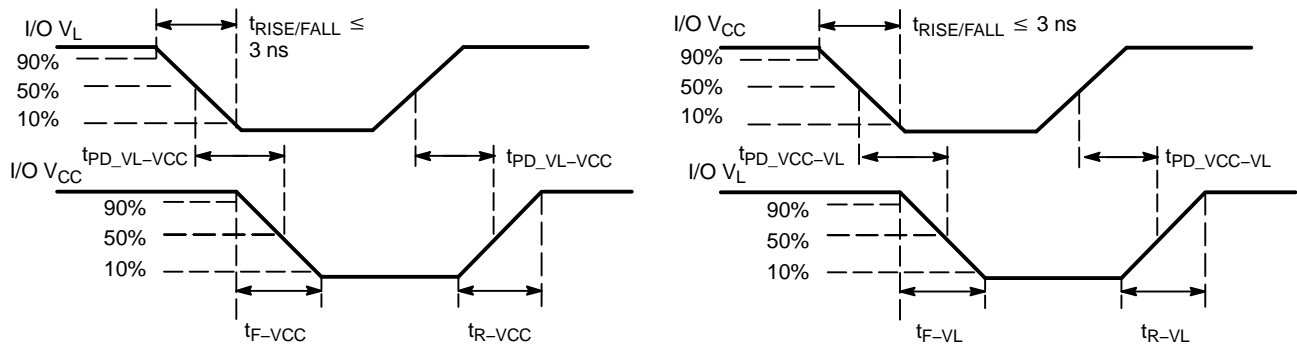
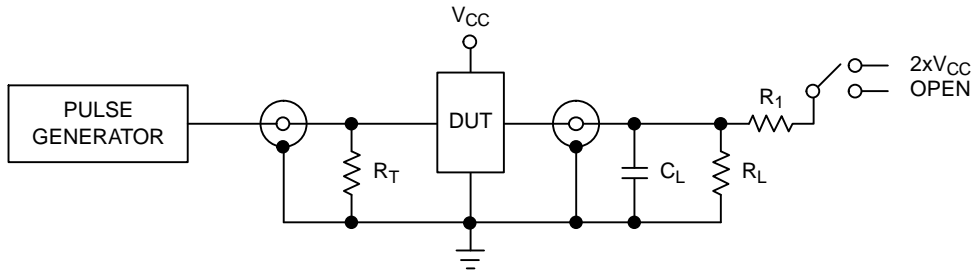

Figure 7. Definition of Timing Specification Parameters

NLSX4401



Test	Switch
t_{PZH} , t_{PHZ}	Open
t_{PZL} , t_{PLZ}	$2 \times V_{CC}$

$C_L = 15 \text{ pF}$ or equivalent (Includes jig and probe capacitance)
 $R_L = R_1 = 50 \text{ k}\Omega$ or equivalent
 $R_T = Z_{OUT}$ of pulse generator (typically 50Ω)

Figure 8. Test Circuit for Enable/Disable Time Measurement

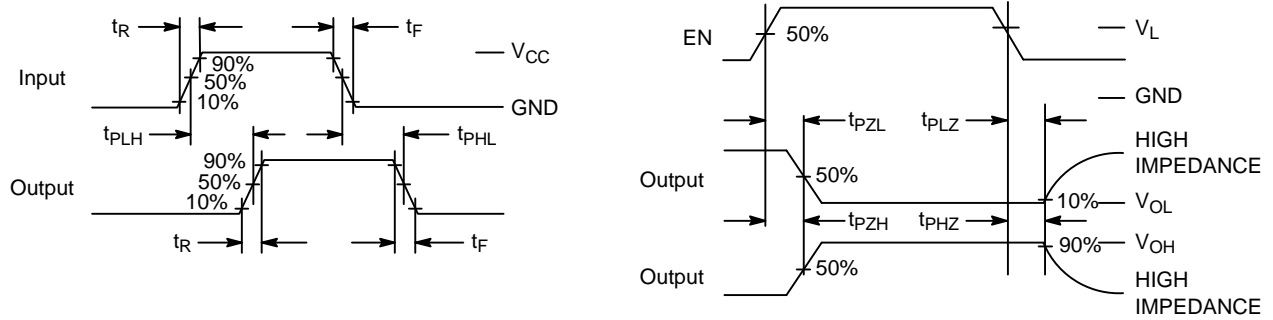

Figure 9. Timing Definitions for Propagation Delays and Enable/Disable Measurement

APPLICATIONS INFORMATION

Level Translator Architecture

The NLSX4401 auto sense translator provides bi-directional voltage level shifting to transfer data in multiple supply voltage systems. This device has two supply voltages, V_L and V_{CC} , which set the logic levels on the input and output sides of the translator. When used to transfer data from the I/O V_L to the I/O V_{CC} ports, input signals referenced to the V_L supply are translated to output signals with a logic level matched to V_{CC} . In a similar manner, the I/O V_{CC} to I/O V_L translation shifts input signals with a logic level compatible to V_{CC} to an output signal matched to V_L .

The NLSX4401 consists of two bi-directional channels that independently determine the direction of the data flow without requiring a directional pin. The one-shot circuits are used to detect the rising or falling input signals. In addition, the one shots decrease the rise and fall time of the output signal for high-to-low and low-to-high transitions.

Each input/output channel has an internal 10 k Ω pull-up. The magnitude of the pull-up resistors can be reduced by connecting external resistors in parallel to the internal 10 k Ω resistors.

Input Driver Requirements

The rise (t_R) and fall (t_F) timing parameters of the open drain outputs depend on the magnitude of the pull-up resistors. In addition, the propagation times (t_{PHL} / t_{PLH}), skew (t_{PSKEW}) and maximum data rate depend on the

impedance of the device that is connected to the translator. The timing parameters listed in the data sheet assume that the output impedance of the drivers connected to the translator is less than 50 k Ω .

Enable Input (EN)

The NLSX4401 has an Enable pin (EN) that provides tri-state operation at the I/O pins. Driving the Enable pin to a low logic level minimizes the power consumption of the device and drives the I/O V_{CC} and I/O V_L pins to a high impedance state. Normal translation operation occurs when the EN pin is equal to a logic high signal. The EN pin is referenced to the V_L supply and has Overvoltage Tolerant (OVT) protection.

Power Supply Guidelines

During normal operation, supply voltage V_L can be greater than, less than or equal to V_{CC} . The sequencing of the power supplies will not damage the device during the power up operation.

For optimal performance, 0.01 μ F to 0.1 μ F decoupling capacitors should be used on the V_{CCA} and V_{CCB} power supply pins. Ceramic capacitors are a good design choice to filter and bypass any noise signals on the voltage lines to the ground plane of the PCB. The noise immunity will be maximized by placing the capacitors as close as possible to the supply and ground pins, along with minimizing the PCB connection traces.

NLSX4401

PACKAGE DIMENSIONS

UDFN6, 1.45x1, 0.5P
CASE 517AQ
ISSUE O

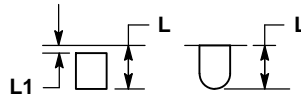
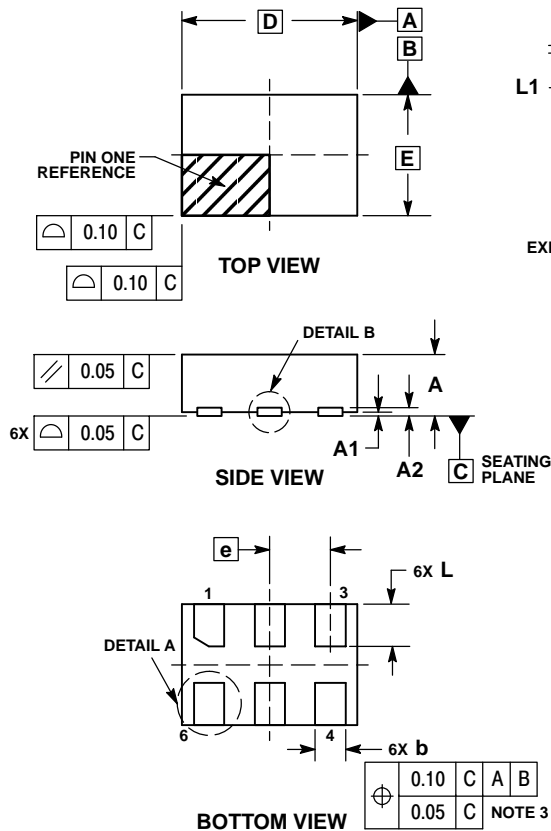

DETAIL A
OPTIONAL
CONSTRUCTIONS

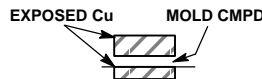

DETAIL B
OPTIONAL
CONSTRUCTIONS

NOTES:

1. DIMENSIONING AND TOLERANCING PER ASME Y14.5M, 1994.
2. CONTROLLING DIMENSION: MILLIMETERS.
3. DIMENSION b APPLIES TO PLATED TERMINAL AND IS MEASURED BETWEEN 0.15 AND 0.30 mm FROM THE TERMINAL TIP.

DIM	MILLIMETERS	
	MIN	MAX
A	0.45	0.55
A1	0.00	0.05
A2	0.07	REF
b	0.20	0.30
D	1.45	BSC
E	1.00	BSC
e	0.50	BSC
L	0.30	0.40
L1	---	0.15

MOUNTING FOOTPRINT

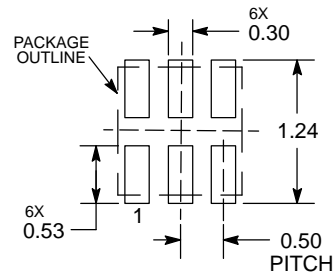

DIMENSIONS: MILLIMETERS

*For additional information on our Pb-Free strategy and soldering details, please download the ON Semiconductor Soldering and Mounting Techniques Reference Manual, SOLDERRM/D.

ON Semiconductor and are registered trademarks of Semiconductor Components Industries, LLC (SCILLC). SCILLC owns the rights to a number of patents, trademarks, copyrights, trade secrets, and other intellectual property. A listing of SCILLC's product/patent coverage may be accessed at www.onsemi.com/site/pdf/Patent-Marketing.pdf. SCILLC reserves the right to make changes without further notice to any products herein. SCILLC makes no warranty, representation or guarantee regarding the suitability of its products for any particular purpose, nor does SCILLC assume any liability arising out of the application or use of any product or circuit, and specifically disclaims any and all liability, including without limitation special, consequential or incidental damages. "Typical" parameters which may be provided in SCILLC data sheets and/or specifications can and do vary in different applications and actual performance may vary over time. All operating parameters, including "Typicals" must be validated for each customer application by customer's technical experts. SCILLC does not convey any license under its patent rights nor the rights of others. SCILLC products are not designed, intended, or authorized for use as components in systems intended for surgical implant into the body, or other applications intended to support or sustain life, or for any other application in which the failure of the SCILLC product could create a situation where personal injury or death may occur. Should Buyer purchase or use SCILLC products for any such unintended or unauthorized application, Buyer shall indemnify and hold SCILLC and its officers, employees, subsidiaries, affiliates, and distributors harmless against all claims, costs, damages, and expenses, and reasonable attorney fees arising out of, directly or indirectly, any claim of personal injury or death associated with such unintended or unauthorized use, even if such claim alleges that SCILLC was negligent regarding the design or manufacture of the part. SCILLC is an Equal Opportunity/Affirmative Action Employer. This literature is subject to all applicable copyright laws and is not for resale in any manner.

PUBLICATION ORDERING INFORMATION

LITERATURE FULFILLMENT:
Literature Distribution Center for ON Semiconductor
P.O. Box 5163, Denver, Colorado 80217 USA
Phone: 303-675-2175 or 800-344-3860 Toll Free USA/Canada
Fax: 303-675-2176 or 800-344-3867 Toll Free USA/Canada
Email: orderlit@onsemi.com

N. American Technical Support: 800-282-9855 Toll Free
USA/Canada
Europe, Middle East and Africa Technical Support:
Phone: 421 33 790 2910
Japan Customer Focus Center
Phone: 81-3-5817-1050

ON Semiconductor Website: www.onsemi.com
Order Literature: <http://www.onsemi.com/orderlit>

For additional information, please contact your local Sales Representative