

Male Style H 15

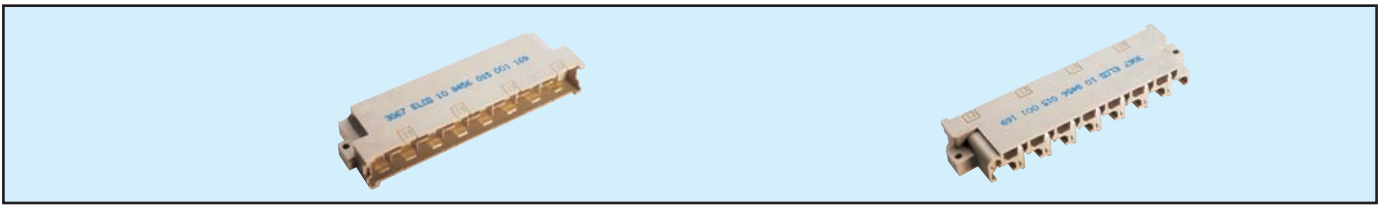

Series 8456 – 2 rows (1 x 7 + 1 x 8)



Contact Design and Termination Length	Number of Contacts	Loading Description	Part Number
			Performance classes according to DIN 41612
Right Angled PCB Solder	15	fully loaded	10 8456 015 001 169
		fully loaded + ground z + z32	59 8456 015 000 004
		fully loaded + ground z4 + z32	10 8456 015 101 169
Faston (6.3 x 0.8)	15	fully loaded	10 8456 015 002 169
		fully loaded + ground z + z32	59 8456 015 000 005
		fully loaded + ground z4 + z32	10 8456 015 102 169

NB: Additional Plating & Loading Variations: Please contact your local AVX sales office or distributor.

LOADING DESCRIPTION

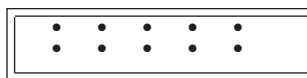

15 contacts, fully loaded

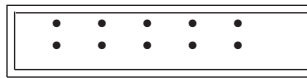

15 contacts, fully loaded with ground z32

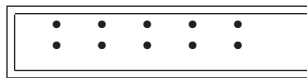

15 contacts, fully loaded with ground z4 + z32

DIMENSIONS

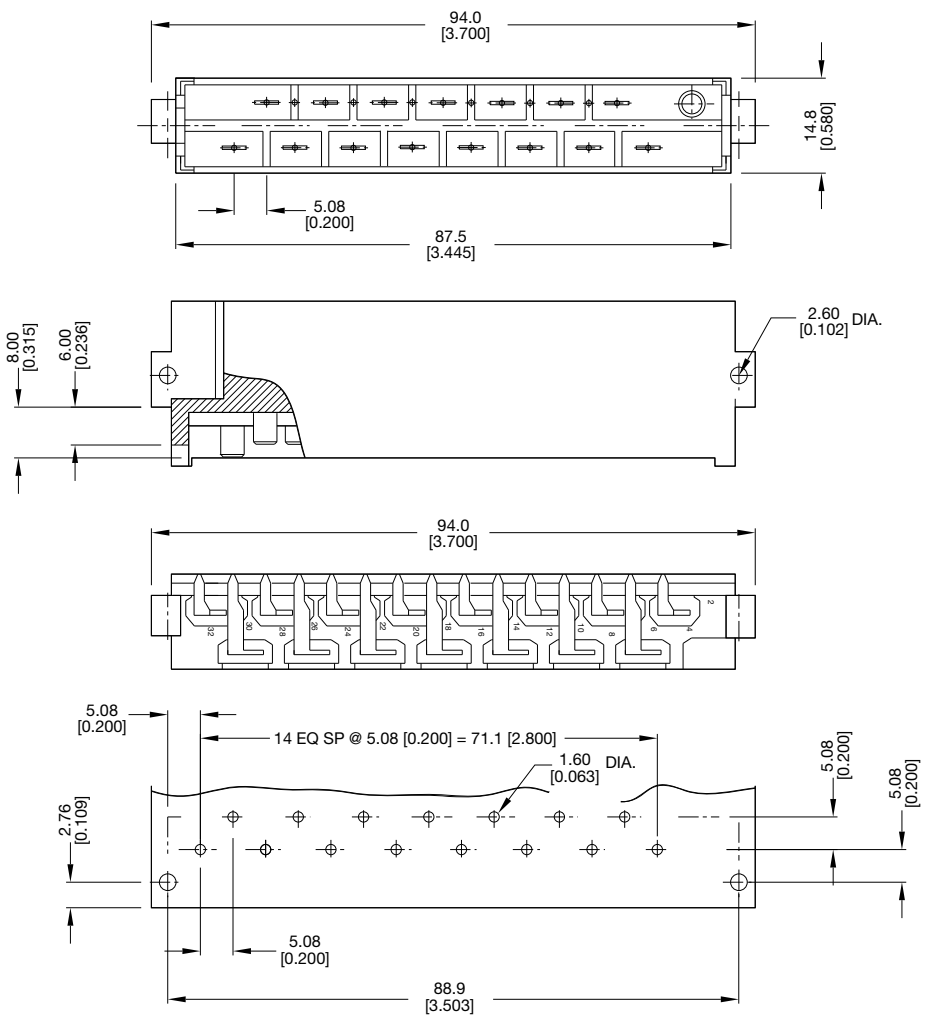

Female Style H 15



Series 8456 – 2 rows (1 x 7 + 1 x 8)

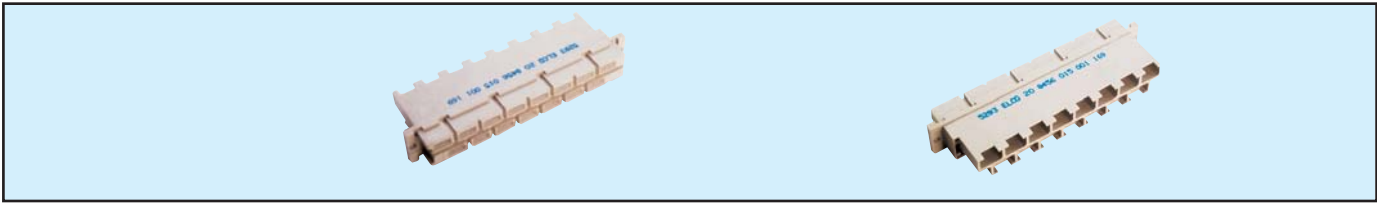

Contact Design and Termination Length	Number of Contacts	Loading Description	Part Number
			Performance classes according to DIN 41612
Faston	15	fully loaded	I
			20 8456 015 001 169
Solder 13.0 mm	15	fully loaded	59 8456 015 000 002
			59 8456 015 000 003
Solder	15	fully loaded	20 8456 015 020 169
Screw	15	fully loaded	59 8456 015 000 001
Solder 4.0mm	15	fully loaded	

NB: Additional Plating & Loading Variations: Please contact your local AVX sales office or distributor.

LOADING DESCRIPTION

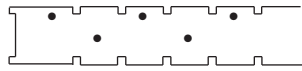

15 contacts, fully loaded

DIMENSIONS

