

Bridgelux® Vero® 18 Array Series

Product Data Sheet DS32



BXRC-27X4000

30X4000

35X4000

40X4000

50X4000

Introduction

Vero



Vero represents a revolutionary advancement in chip on board (COB) light source technology and innovation. Vero LED light sources simplify luminaire design and manufacturing processes, improve light quality, and define a platform for future functionality integration.

Vero is available in four different light emitting surface (LES) configurations and has been engineered to reliably operate over a broad current range, enabling new degrees of flexibility in luminaire design optimization. Vero arrays deliver increased lumen density to enable improved beam control and precision lighting with 2 and 3 SDCM color control standard for clean and consistent uniform lighting.

Vero includes an on board connector port to enable solder free electrical interconnect and simple easy to use mounting features to enable plug-and-play installation.

Features

- Efficacy of 130 lm/W typical
- Vero 18 lumen output performance ranges from 1600 to 7875 lumens
- Broad range of CCT options from 2700K to 5000K
- CRI options include minimum 70, 80, and 90, 2 and 3 SDCM color control for 2700K-4000K CCT
- Reliable operation at up to 2X nominal drive current
- Radial die pattern and improved lumen density
- Thermally isolated solder pads
- Onboard connector port
- Top side part number markings

Benefits

- Broad application coverage for interior and exterior lighting
- Flexibility for application driven lighting design requirements
- High quality true color reproduction
- Uniform consistent white light
- Flexibility in design optimization
- Improved optical control
- Enhanced ease of use and manufacturability
- Solderless connectivity enables plug & play installation and field upgradability
- Improved inventory management and quality control

Contents

Product Feature Map	2
Product Nomenclature	2
Product Selection Guide	3
Performance at Commonly Used Drive Currents	4
Electrical Characteristics	6
Absolute Maximum Ratings	7
Performance Curves	8
Typical Radiation Pattern	11
Typical Color Spectrum	12
Mechanical Dimensions	13
Color Binning Information	14
Packaging and Labeling	15
Design Resources	17
Precautions	17
Disclaimers	17
About Bridgelux	18

Product Feature Map

Vero 18 is the second largest form factor in the Vero family of next generation solid state light sources. In addition to delivering the performance and light quality required for many lighting applications, Vero incorporates

several features to simplify the design integration and manufacturing process, accelerate time to market and reduce system costs. Please consult the Bridgelux Vero Array Series Product Brief for more information on the Vero family of products.

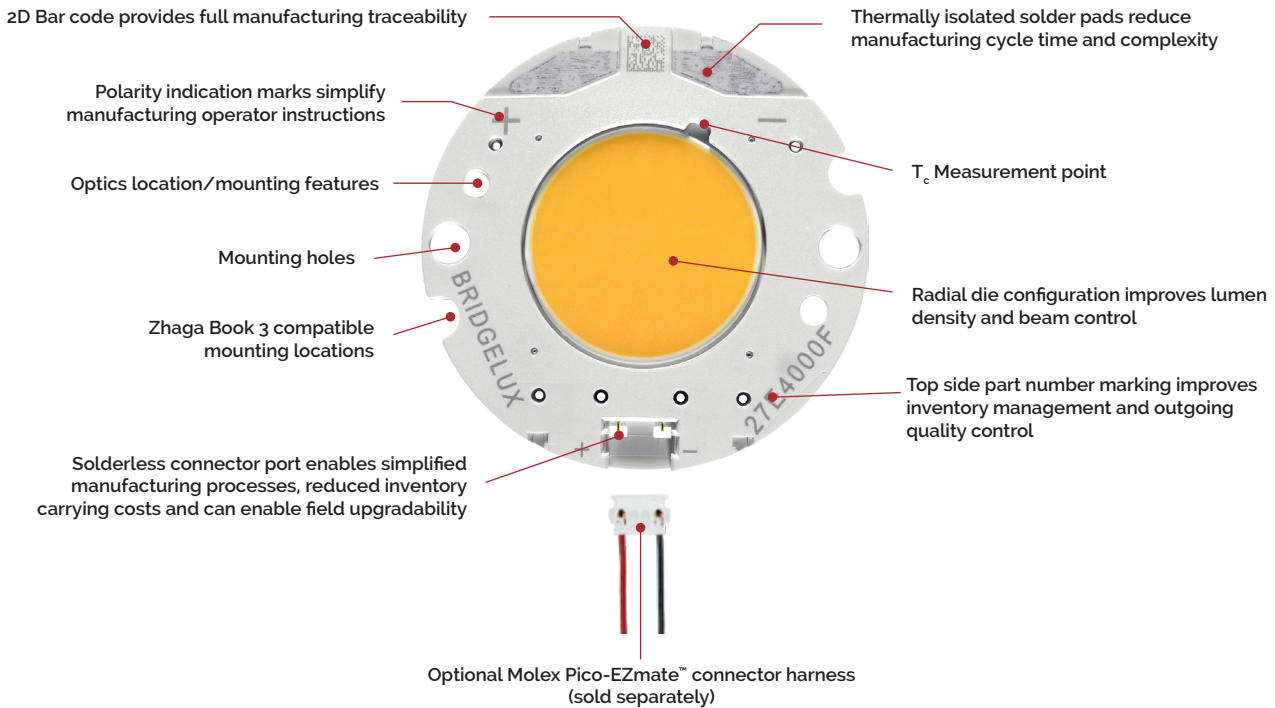

Product Nomenclature

The part number designation for Bridgelux Vero LED arrays is explained as follows:

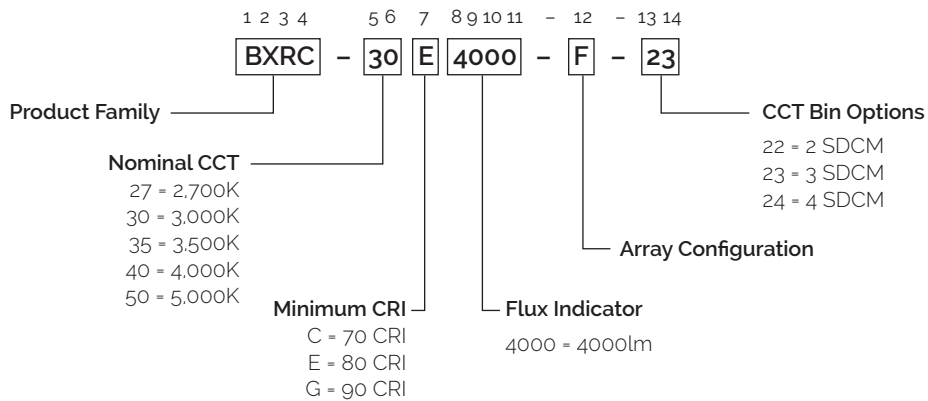

Product Selection Guide

The following product configurations are available:

Table 1: Selection Guide, Pulsed Measurement Data ($T_j = T_c = 25^\circ\text{C}$)

Part Number	Nominal CCT ¹ (K)	CRI ²	Nominal Drive Current ³ (mA)	Typical Pulsed Flux ^{4,5,6} $T_c = 25^\circ\text{C}$ (lm)	Minimum Pulsed Flux ^{6,7} $T_c = 25^\circ\text{C}$ (lm)	Typical V_f (V)	Typical Power (W)	Typical Efficacy (lm/W)
BXRC-27E4000-F-2x	2700	80	1050	3961	3723	29.5	31.0	128
BXRC-27G4000-F-2x	2700	90	1050	3224	3010	29.5	31.0	104
BXRC-30E4000-F-2x	3000	80	1050	4097	3698	29.5	31.0	132
BXRC-30G4000-F-2x	3000	90	1050	3423	3152	29.5	31.0	111
BXRC-35E4000-F-2x	3500	80	1050	4289	3866	29.5	31.0	138
BXRC-35G4000-F-2x	3500	90	1050	3655	3256	29.5	31.0	118
BXRC-40E4000-F-2x	4000	80	1050	4341	3931	29.5	31.0	140
BXRC-40G4000-F-2x	4000	90	1050	3750	3529	29.5	31.0	121
BXRC-50C4000-F-24	5000	70	1050	4603	4303	29.5	31.0	149
BXRC-50E4000-F-24	5000	80	1050	4305	4070	29.5	31.0	139
BXRC-50G4000-F-24	5000	90	1050	3885	3697	29.5	31.0	125

Table 2: Selection Guide, Stabilized DC Performance ($T_c = 85^\circ\text{C}$)^{8,9}

Part Number	Nominal CCT ¹ (K)	CRI ²	Nominal Drive Current ³ (mA)	Typical DC Flux $T_c = 85^\circ\text{C}$ (lm)	Minimum DC Flux ¹⁰ $T_c = 85^\circ\text{C}$ (lm)	Typical V_f (V)	Typical Power (W)	Typical Efficacy (lm/W)
BXRC-27E4000-F-2x	2700	80	1050	3592	3376	28.6	30.0	120
BXRC-27G4000-F-2x	2700	90	1050	2837	2649	28.6	30.0	94
BXRC-30E4000-F-2x	3000	80	1050	3705	3344	28.6	30.0	123
BXRC-30G4000-F-2x	3000	90	1050	3012	2774	28.6	30.0	100
BXRC-35E4000-F-2x	3500	80	1050	3896	3512	28.6	30.0	130
BXRC-35G4000-F-2x	3500	90	1050	3216	2865	28.6	30.0	107
BXRC-40E4000-F-2x	4000	80	1050	3920	3550	28.6	30.0	131
BXRC-40G4000-F-2x	4000	90	1050	3300	3106	28.6	30.0	110
BXRC-50C4000-F-24	5000	70	1050	4051	3787	28.6	30.0	135
BXRC-50E4000-F-24	5000	80	1050	3788	3582	28.6	30.0	126
BXRC-50G4000-F-24	5000	90	1050	3419	3253	28.6	30.0	114

Notes for Tables 1 & 2:

- Nominal CCT as defined by ANSI C78.377-2011.
- CRI Values are minimums. Minimum R_g value for 80 CRI products is 0, the minimum R_g values for 90 CRI products is 50.
- Drive current is referred to as nominal drive current.
- Products tested under pulsed condition (10ms pulse width) at nominal test current where T_j (junction temperature) - T_c (case temperature) = 25°C .
- Typical performance values are provided as a reference only and are not a guarantee of performance.
- Bridgelux maintains a $\pm 7\%$ tolerance on flux measurements.
- Minimum flux values at the nominal test current are guaranteed by 100% test.
- Typical stabilized DC performance values are provided as reference only and are not a guarantee of performance.
- Typical performance is estimated based on operation under DC (direct current) with LED array mounted onto a heat sink with thermal interface material and the case temperature maintained at 85°C . Based on Bridgelux test setup, values may vary depending on the thermal design of the luminaire and/or the exposed environment to which the product is subjected.
- Minimum flux values at elevated temperatures are provided for reference only and are not guaranteed by 100% production testing. Based on Bridgelux test setup, values may vary depending on the thermal design of the luminaire and/or the exposed environment to which the product is subjected.

Performance at Commonly Used Drive Currents

Vero LED arrays are tested to the specifications shown using the nominal drive currents in Table 1. Vero may also be driven at other drive currents dependent on specific application design requirements. The performance at any drive current can be derived from the current vs. voltage characteristics shown in Figure 1 and the flux vs. current characteristics shown in Figure 2. The performance at commonly used drive currents is summarized in Table 3.

Table 3: Performance at Commonly Used Drive Currents

Part Number	CRI	Drive Current ¹ (mA)	Typical V_f $T_c = 25^\circ\text{C}$ (V)	Typical Power $T_c = 25^\circ\text{C}$ (W)	Typical Flux ² $T_c = 25^\circ\text{C}$ (lm)	Typical DC Flux ³ $T_c = 85^\circ\text{C}$ (lm)	Typical Efficacy $T_c = 25^\circ\text{C}$ (lm/W)
BXRC-27E4000-F-2x	80	500	28.1	14.1	2042	1846	145
		700	28.7	20.1	2779	2513	138
		1050	29.5	31.0	3961	3592	128
		1400	30.2	42.3	5032	4575	119
		2100	31.6	66.4	6777	6211	102
BXRC-27G4000-F-2x	90	500	28.1	14.1	1662	1458	118
		700	28.7	20.1	2262	1985	113
		1050	29.5	31.0	3224	2837	104
		1400	30.2	42.3	4096	3614	97
		2100	31.6	66.4	5516	4905	83
BXRC-30E4000-F-2x	80	500	28.1	14.1	2112	1903	150
		700	28.7	20.1	2874	2592	143
		1050	29.5	31.0	4097	3705	132
		1400	30.2	42.3	5205	4718	123
		2100	31.6	66.4	7009	6405	106
BXRC-30G4000-F-2x	90	500	28.1	14.1	1764	1548	126
		700	28.7	20.1	2402	2107	120
		1050	29.5	31.0	3423	3012	111
		1400	30.2	42.3	4349	3837	103
		2100	31.6	66.4	5856	5208	88
BXRC-35E4000-F-2x	80	500	28.1	14.1	2211	2002	157
		700	28.7	20.1	3009	2726	150
		1050	29.5	31.0	4289	3896	138
		1400	30.2	42.3	5449	4963	129
		2100	31.6	66.4	7338	6736	111
BXRC-35G4000-F-2x	90	500	28.1	14.1	1884	1653	134
		700	28.7	20.1	2564	2250	128
		1050	29.5	31.0	3655	3216	118
		1400	30.2	42.3	4643	4097	110
		2100	31.6	66.4	6253	5561	94

Notes for Table 3:

1. Alternate drive currents in Table 3 are provided for reference only and are not a guarantee of performance.
2. Bridgelux maintains a $\pm 7\%$ tolerance on flux measurements.
3. Typical stabilized DC performance values are provided as reference only and are not a guarantee of performance.

Performance at Commonly Used Drive Currents

Table 3: Performance at Commonly Used Drive Currents (Continued)

Part Number	CRI	Drive Current ¹ (mA)	Typical V_f $T_c = 25^\circ\text{C}$ (V)	Typical Power $T_c = 25^\circ\text{C}$ (W)	Typical Flux ² $T_c = 25^\circ\text{C}$ (lm)	Typical DC Flux ³ $T_c = 85^\circ\text{C}$ (lm)	Typical Efficacy $T_c = 25^\circ\text{C}$ (lm/W)
BXRC-40E4000-F-2x	80	500	28.1	14.1	2238	2014	159
		700	28.7	20.1	3046	2743	152
		1050	29.5	31.0	4341	3920	140
		1400	30.2	42.3	5515	4993	130
		2100	31.6	66.4	7427	6778	112
BXRC-40G4000-F-2x	90	500	28.1	14.1	1933	1696	138
		700	28.7	20.1	2631	2309	131
		1050	29.5	31.0	3750	3300	121
		1400	30.2	42.3	4764	4203	113
		2100	31.6	66.4	6416	5705	97
BXRC-50C4000-F-24	70	500	28.1	14.1	2373	2081	169
		700	28.7	20.1	3229	2834	161
		1050	29.5	31.0	4603	4051	149
		1400	30.2	42.3	5848	5159	138
		2100	31.6	66.4	7875	7003	119
BXRC-50E4000-F-24	80	500	28.1	14.1	2219	1947	158
		700	28.7	20.1	3020	2651	150
		1050	29.5	31.0	4305	3788	139
		1400	30.2	42.3	5469	4825	129
		2100	31.6	66.4	7365	6550	111
BXRC-50G4000-F-24	90	500	28.1	14.1	2003	1757	143
		700	28.7	20.1	2726	2392	136
		1050	29.5	31.0	3885	3419	125
		1400	30.2	42.3	4936	4354	117
		2100	31.6	66.4	6647	5911	100

Notes for Table 3:

1. Alternate drive currents in Table 3 are provided for reference only and are not a guarantee of performance.
2. Bridgelux maintains a $\pm 7\%$ tolerance on flux measurements.
3. Typical stabilized DC performance values are provided as reference only and are not a guarantee of performance.

Electrical Characteristics

Table 4: Electrical Characteristics

Part Number	Drive Current (mA)	Forward Voltage Pulsed, $T_c = 25^\circ\text{C}$ (V) ^{1, 2, 3}			Typical Coefficient of Forward Voltage ⁴ $\Delta V_f / \Delta T$ (mV/ $^\circ\text{C}$)	Typical Thermal Resistance Junction to Case ^{5, 6} R_{j-c} (C/W)	Driver Selection Voltages ⁷ (V)	
		Minimum	Typical	Maximum			V_f Min. Hot $T_c = 105^\circ\text{C}$ (V)	V_f Max. Cold $T_c = -40^\circ\text{C}$ (V)
BXRC-xxx4000-F-2x	1050	27.3	29.5	31.7	-15	0.13	26.1	32.7
	2100	29.2	31.6	34.2	-15	0.17	28.0	35.2

Notes for Table 4:

- Parts are tested in pulsed conditions, $T_c = 25^\circ\text{C}$. Pulse width is 10ms.
- Voltage minimum and maximum are provided for reference only and are not a guarantee of performance.
- Bridgelux maintains a tester tolerance of $\pm 0.10\text{V}$ on forward voltage measurements.
- Typical coefficient of forward voltage tolerance is $\pm 0.1\text{mV}$ for nominal current.
- Thermal resistance values are based from test data of a 3000K 80 CRI product.
- Thermal resistance value was calculated using total electrical input power; optical power was not subtracted from input power. The thermal interface material used during testing is not included in the thermal resistance value.
- V_f min hot and max cold values are provided as reference only and are not guaranteed by test. These values are provided to aid in driver design and selection over the operating range of the product.

Absolute Maximum Ratings

Table 5: Maximum Ratings

Parameter	Maximum Rating
LED Junction Temperature (T_j)	150°C
Storage Temperature	-40°C to +105°C
Operating Case Temperature ¹ (T_c)	105°C
Soldering Temperature ²	350°C or lower for a maximum of 10 seconds
Maximum Drive Current ^{3,4,5}	2100mA
Maximum Peak Pulsed Drive Current ⁶	3000mA
Maximum Reverse Voltage ⁷	-50V

Notes for Table 5:

1. For IEC 62717 requirement, please consult your Bridgelux sales representative.
2. Refer to Bridgelux Application Note AN31: Assembly Considerations for Bridgelux Vero LED Arrays.
3. DC Forward Current for LM-80 is the maximum drive current for which LM-80 data is currently available.
4. Lumen maintenance (L70) and lifetime predictions are valid for drive current and case temperature conditions used for LM-80 testing as included in the applicable LM-80 test report for these arrays. Contact your Bridgelux sales representatives for LM-80 report.
5. Arrays may be driven at higher currents however lumen maintenance may be reduced.
6. Bridgelux recommends a maximum duty cycle of 10% and pulse width of 20 ms when operating LED Arrays at maximum peak pulsed current specified. Maximum peak pulsed currents indicate values where LED Arrays can be driven without catastrophic failures.
7. Light emitting diodes are not designed to be driven in reverse voltage and will not produce light under this condition. Maximum rating provided for reference only.

Performance Curves

Figure 1: Drive Current vs. Voltage ($T_j = T_c = 25^\circ\text{C}$)

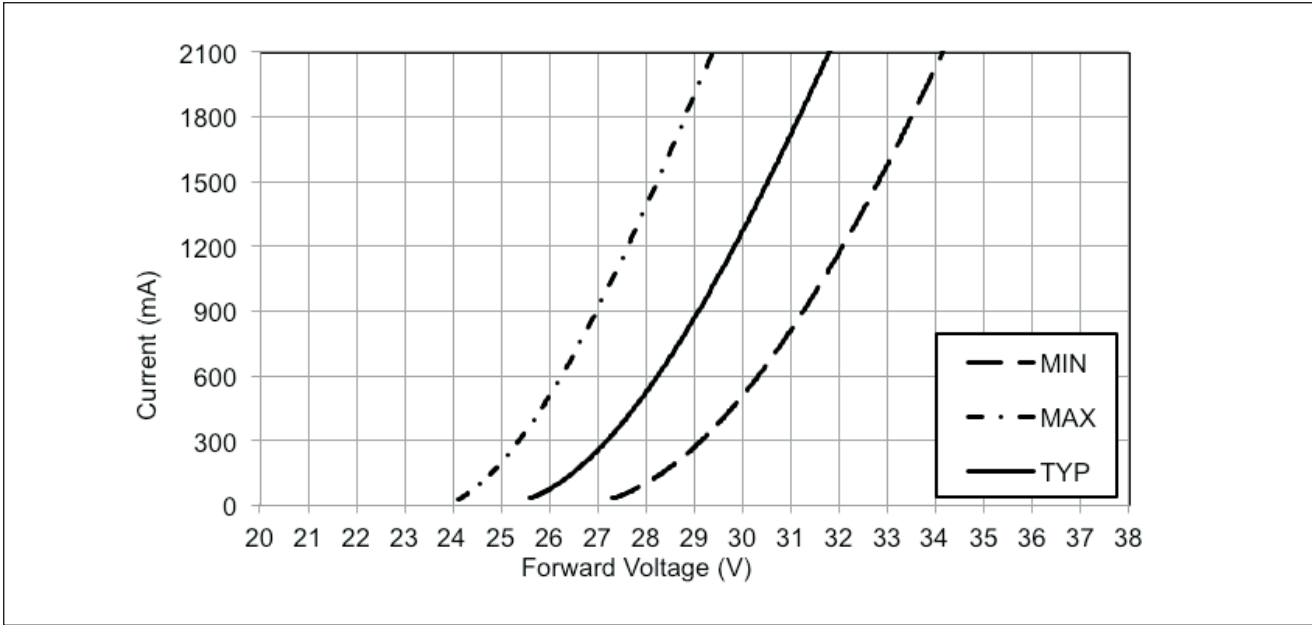
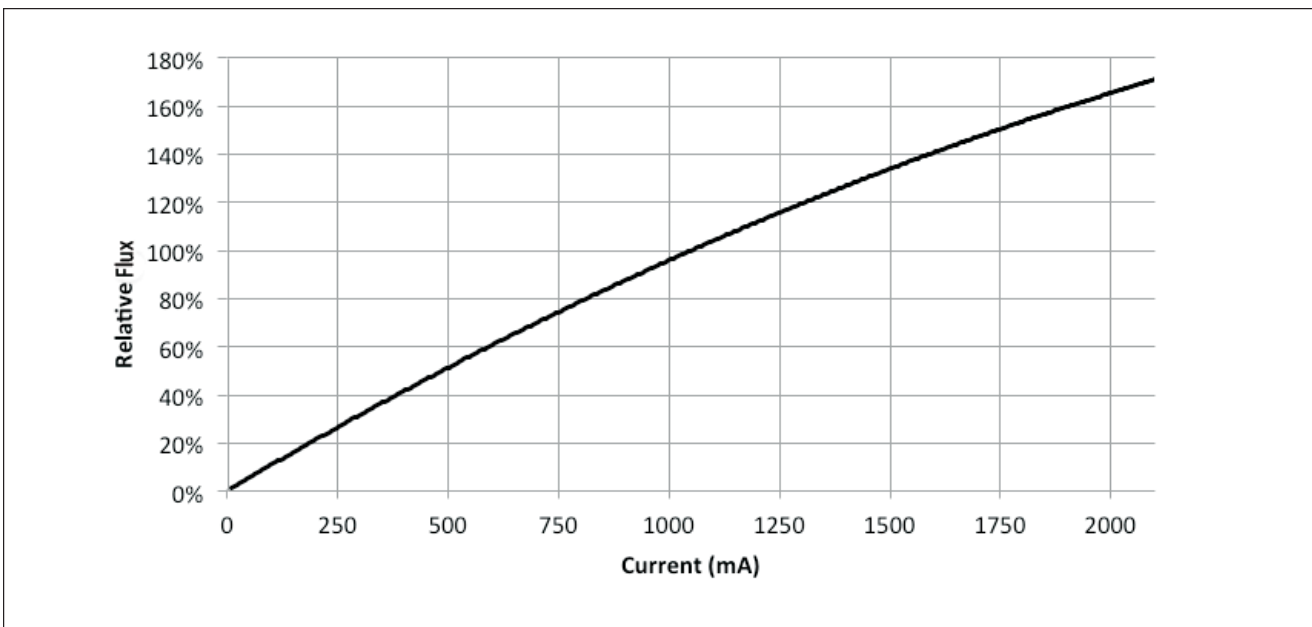

Figure 2: Typical Relative Luminous Flux vs. Drive Current ($T_j = T_c = 25^\circ\text{C}$)



Note for Figure 2:

1. Bridgelux does not recommend driving high power LEDs at low currents. Doing so may produce unpredictable results. Pulse width modulation (PWM) is recommended for dimming effects.

Performance Curves

Figure 3: Typical DC Flux vs. Case Temperature

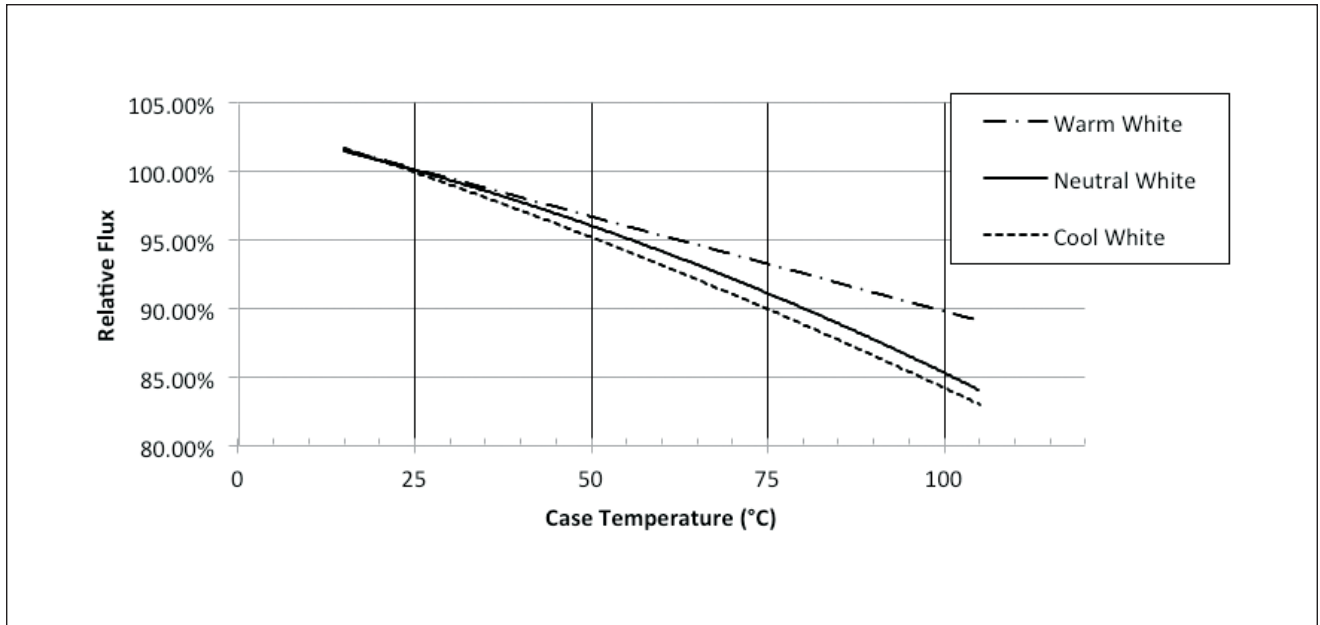
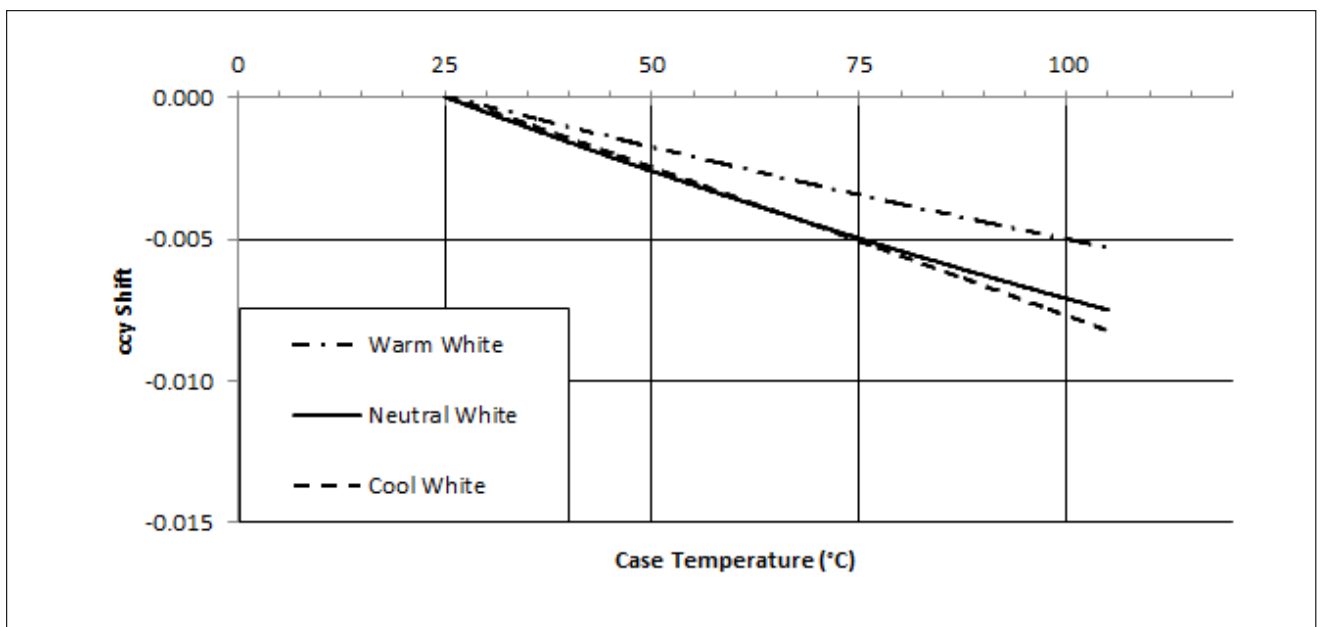

Figure 4: Typical DC ccy Shift vs. Case Temperature



Notes for Figures 3-4:

1. Characteristics shown for warm white based on 3000K and 80 CRI.
2. Characteristics shown for neutral white based on 4000K and 80 CRI.
3. Characteristics shown for cool white based on 5000K and 70 CRI.
4. For other color SKUs, the shift in color will vary. Please contact your Bridgelux Sales Representative for more information.

Performance Curves

Figure 5: Typical DC ccx Shift vs. Case Temperature

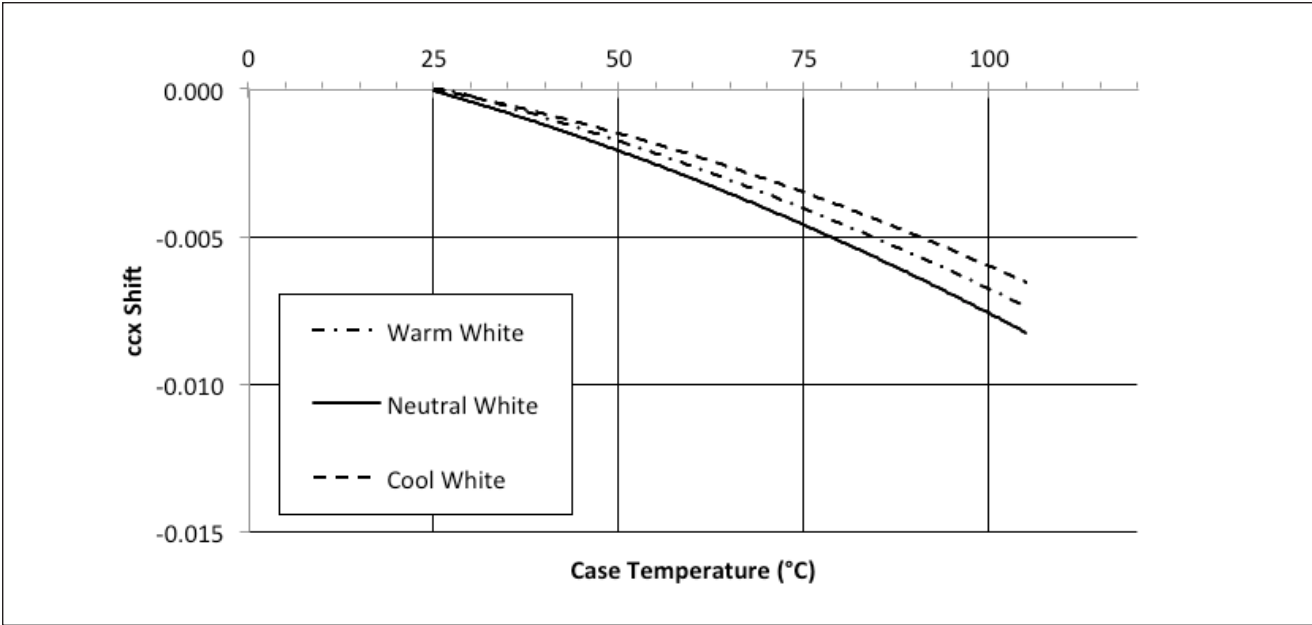

Notes for Figure 5:

- 1. Characteristics shown for warm white based on 3000K and 80 CRI.
- 2. Characteristics shown for neutral white based on 4000K and 80 CRI.
- 3. Characteristics shown for cool white based on 5000K and 70 CRI.
- 4. For other color SKUs, the shift in color will vary. Please contact your Bridgelux Sales Representative for more information.

Typical Radiation Pattern

Figure 6: Typical Spatial Radiation Pattern

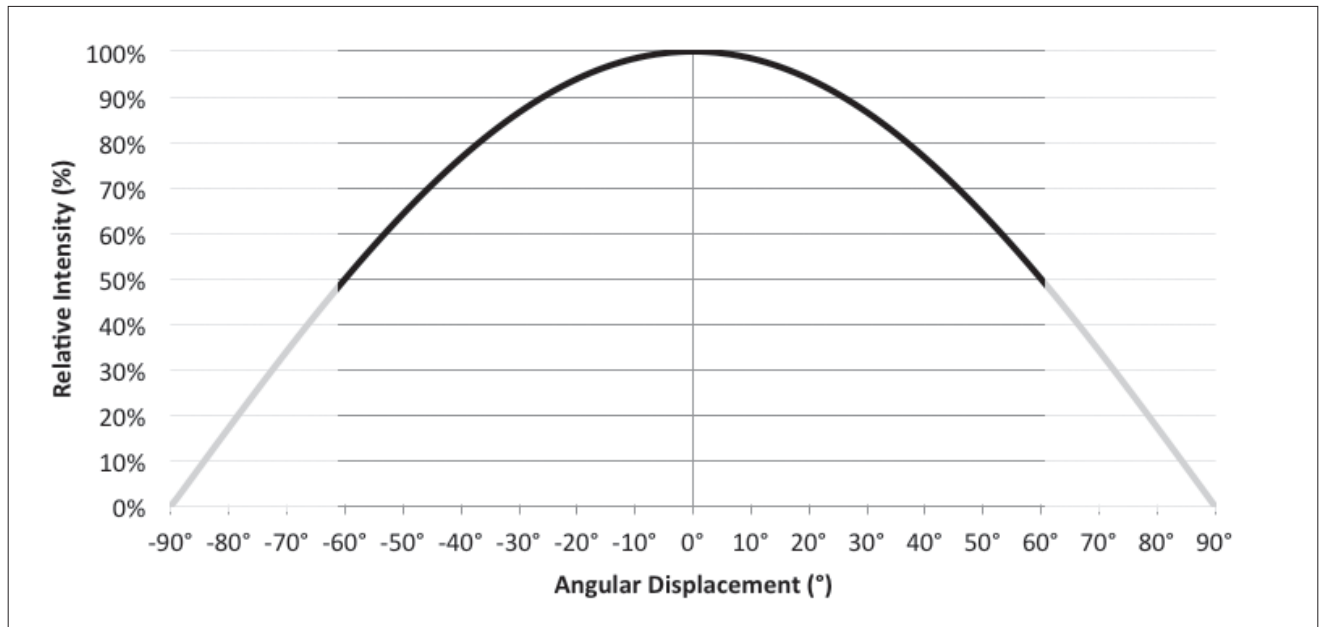

Note for Figure 6:

1. Typical viewing angle is 120°.
2. The viewing angle is defined as the off axis angle from the centerline where intensity is ½ of the peak value.

Figure 7: Typical Polar Radiation Pattern

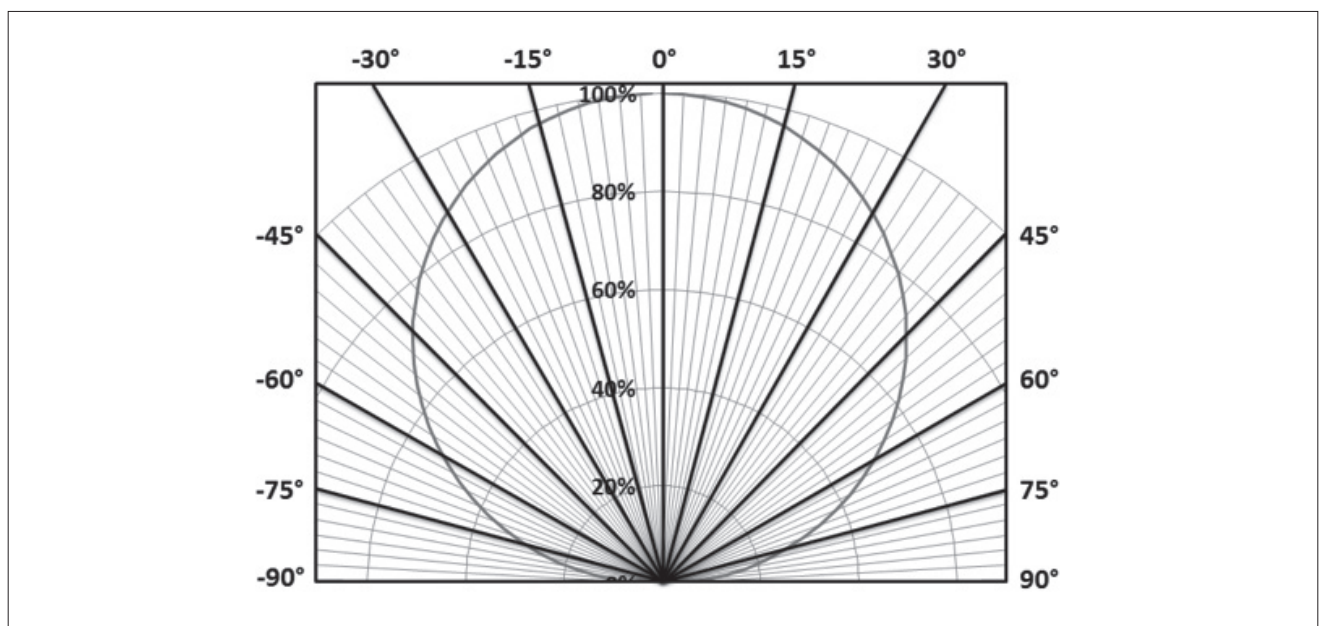

Typical Color Spectrum

Figure 8: Typical Color Spectrum

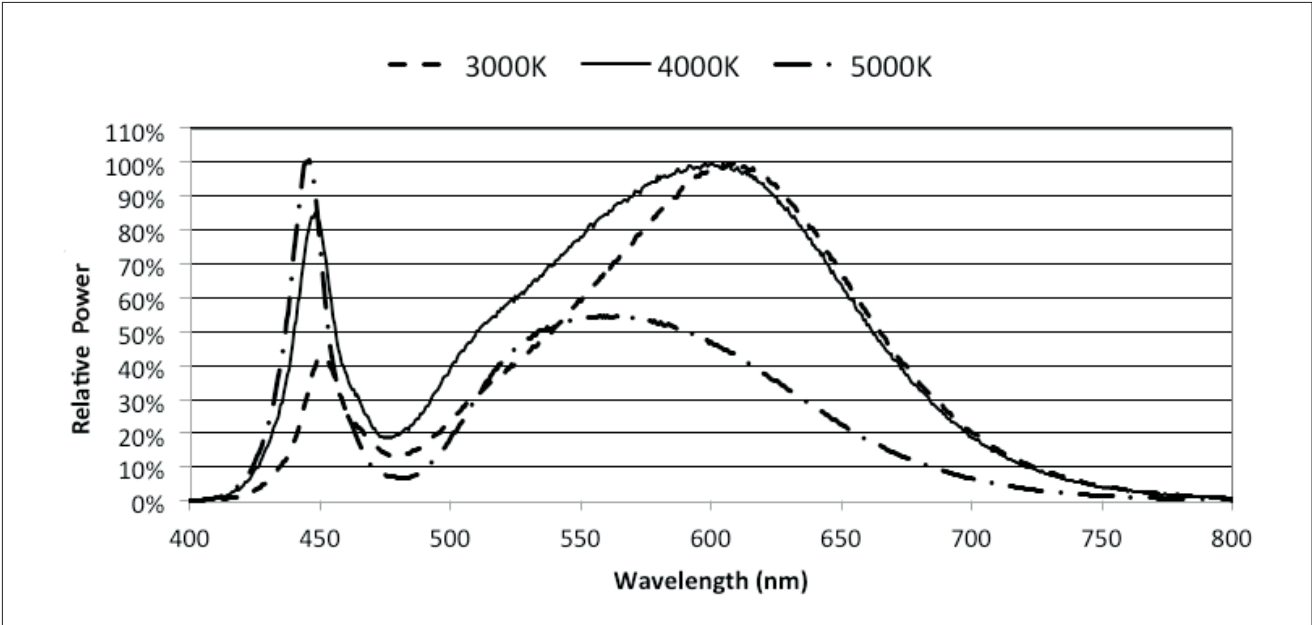

- Notes for Figure 8:
1. Color spectra measured at nominal current for $T_j = T_c = 25^\circ\text{C}$.
 2. Color spectra shown is 3000K and 80 CRI.
 3. Color spectra shown is 4000K and 80 CRI.
 4. Color spectra shown is 5000K and 70 CRI.

Mechanical Dimensions

Figure 9: Drawing for Vero 18 LED Array

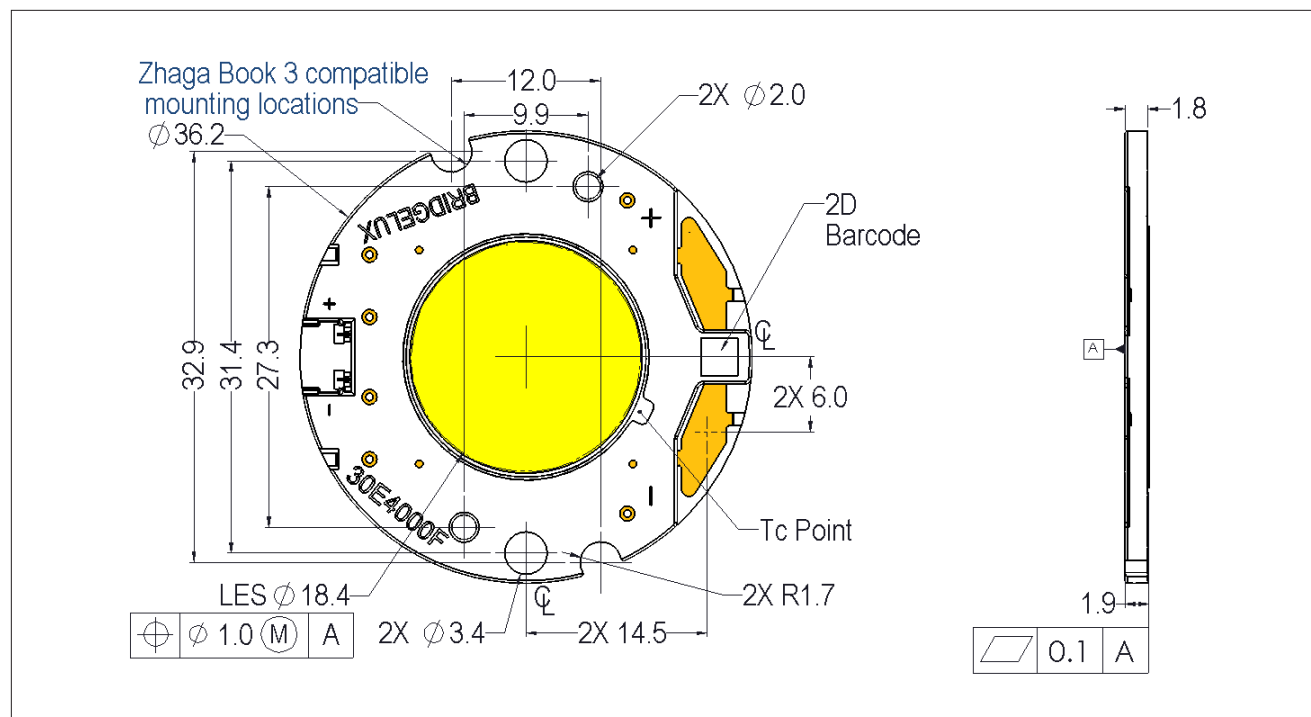

Notes for Figure 9:

1. Drawings are not to scale.
2. Drawing dimensions are in millimeters.
3. Unless otherwise specified, tolerances are $\pm 0.1\text{mm}$.
4. Mounting holes (2X) are for M2.5 screws.
5. Bridgelux recommends two tapped holes for mounting screws with $31.4 \pm 0.10\text{mm}$ center-to-center spacing.
6. Screws with flat shoulders (pan, dome, button, round, truss, mushroom) provide optimal torque control. Do NOT use flat, countersink, or raised head screws.
7. Solder pads and connector port are labeled "+" and "-" to denote positive and negative, respectively.
8. It is not necessary to provide electrical connections to both the solder pads and the connector port. Either set may be used depending on application specific design requirements.
9. Refer to Application Notes AN30 and AN31 for product handling, mounting and heat sink recommendations.
10. The optical center of the LED Array is nominally defined by the mechanical center of the array to a tolerance of $\pm 0.2\text{mm}$.
11. Bridgelux maintains a flatness of 0.10mm across the mounting surface of the array.

Color Binning Information

Figure 10: Graph of Warm and Neutral White Test Bins in xy Color Space

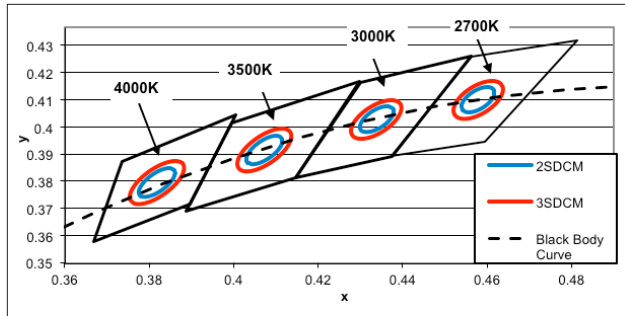

Note: Pulsed Test Conditions, $T_c = 25^\circ\text{C}$

Table 6: Warm and Neutral White xy Bin Coordinates and Associated Typical CCT

Bin Code	2700K	3000K	3500K	4000K
ANSI Bin (for reference only)	(2580K - 2870K)	(2870K - 3220K)	(3220K - 3710K)	(3710K - 4260K)
23 (3SDCM)	(2651K - 2794K)	(2968K - 3136K)	(3369K - 3586K)	(3851K - 4130K)
22 (2SDCM)	(2674K - 2769K)	(2995K - 3107K)	(3404K - 3548K)	(3895K - 4081K)
Center Point (x,y)	(0.4578, 0.4101)	(0.4338, 0.403)	(0.4073, 0.3917)	(0.3818, 0.3797)

Figure 11: Graph of Cool White Test Bins in xy Color Space

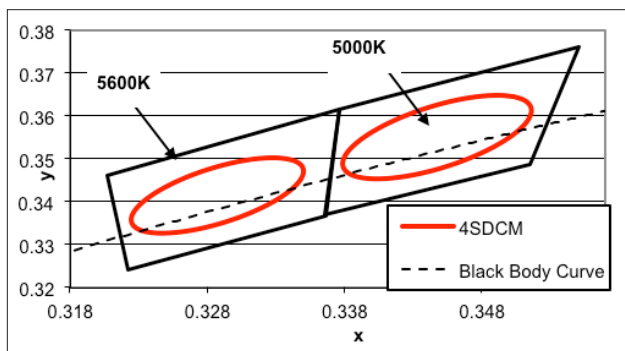

Note: Pulsed Test Conditions, $T_c = 25^\circ\text{C}$

Table 7: Cool White xy Bin Coordinates and Associated Typical CCT

Bin Code	5000K	5600K
ANSI Bin (for reference only)	(4745K - 5311K)	(5310K - 6020K)
24 (4SDCM)	(4801K - 5282K)	(5475K - 5830K)
Center Point (x,y)	(0.3447, 0.3553)	(0.3293, 0.3423)

Packaging and Labeling

Figure 12: Drawing for Vero 18 Packaging Tray

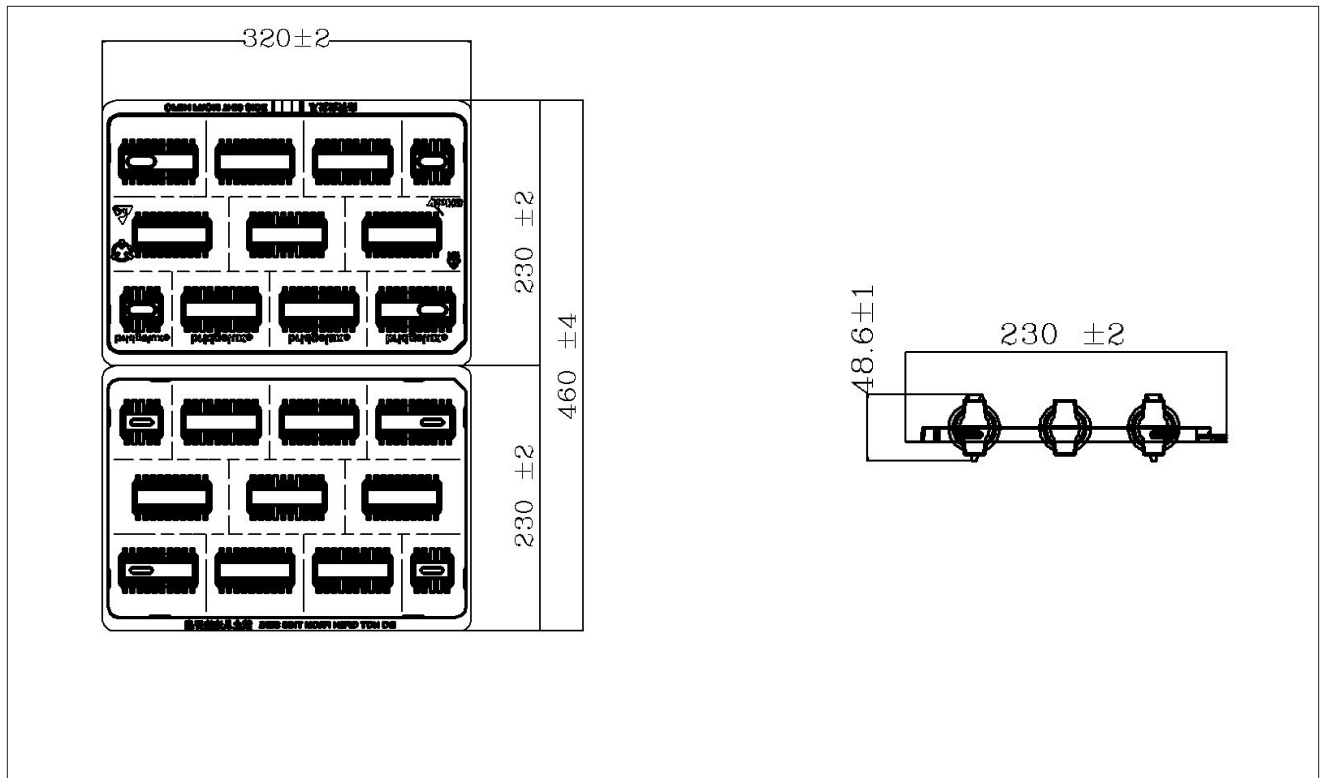

Notes for Figure 12:

1. Dimensions are in millimeters.
2. Drawing is not to scale.

Packaging and Labeling

Figure 13: Vero Series Packaging and Labeling

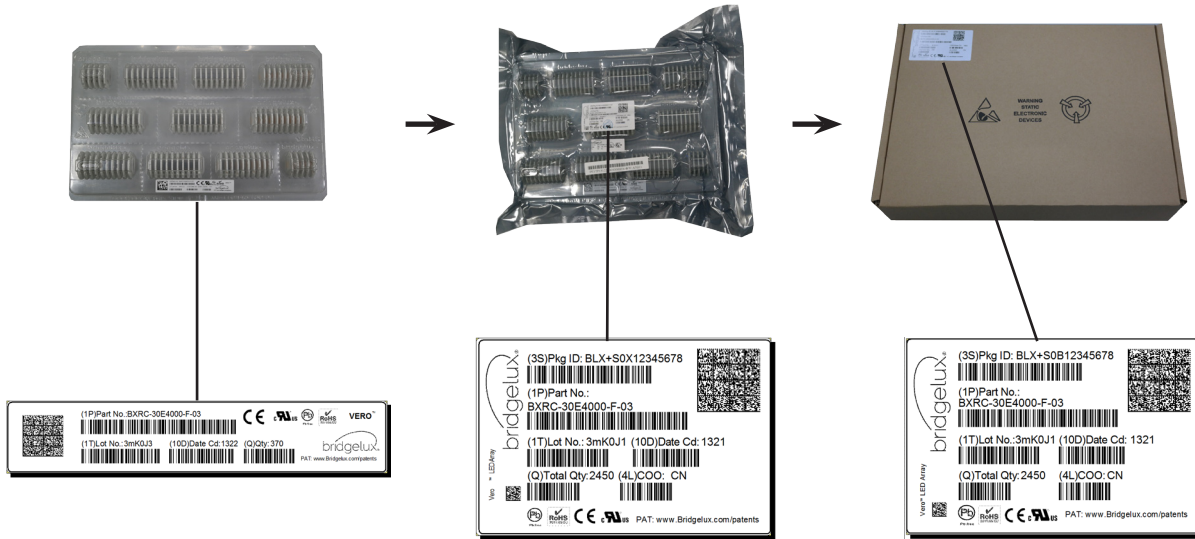

Notes for Figure 13:

1. Each tray holds 100 COBs.
2. Each tray is vacuum sealed in an anti-static bag and placed in its own box.
3. Each tray, bag and box is to be labeled as shown above.

Figure 14: Product Labeling

Bridgelux COB arrays have laser markings on the back side of the substrate to help with product identification. In addition to the product identification markings, Bridgelux COB arrays also contain markings for internal Bridgelux manufacturing use only. The image below shows which markings are for customer use and which ones are for Bridgelux internal use only. The Bridgelux internal manufacturing markings are subject to change without notice, however these will not impact the form, function or performance of the COB array.



Design Resources

Application Notes

Bridgelux has developed a comprehensive set of application notes and design resources to assist customers in successfully designing with the Vero product family of LED array products. For all available application notes visit www.bridgelux.com.

Optical Source Models

Optical source models and ray set files are available for all Bridgelux products. For a list of available formats, visit www.bridgelux.com.

3D CAD Models

Three dimensional CAD models depicting the product outline of all Bridgelux Vero LED arrays are available in both IGS and STEP formats. Please contact your Bridgelux sales representative for assistance.

Precautions

CAUTION: CHEMICAL EXPOSURE HAZARD

Exposure to some chemicals commonly used in luminaire manufacturing and assembly can cause damage to the LED array. Please consult Bridgelux Application Note AN31 for additional information.

CAUTION: EYE SAFETY

Eye safety classification for the use of Bridgelux Vero LED arrays is in accordance with IEC specification EN62471: Photobiological Safety of Lamps and Lamp Systems. Vero LED arrays are classified as Risk Group 1 (Low Risk) when operated at or below the maximum drive current. Please use appropriate precautions. It is important that employees working with LEDs are trained to use them safely.

CAUTION: RISK OF BURN

Do not touch the Vero LED array during operation. Allow the array to cool for a sufficient period of time before handling. The Vero LED array may reach elevated temperatures such that could burn skin when touched.

CAUTION

CONTACT WITH LIGHT EMITTING SURFACE (LES)

Avoid any contact with the LES. Do not touch the LES of the LED array or apply stress to the LES (yellow phosphor resin area). Contact may cause damage to the LED array.

Optics and reflectors must not be mounted in contact with the LES (yellow phosphor resin area). Optical devices may be mounted on the top surface of the plastic housing of the Vero LED array. Use the mechanical features of the LED array housing, edges and/or mounting holes to locate and secure optical devices as needed.

Disclaimers

MINOR PRODUCT CHANGE POLICY

The rigorous qualification testing on products offered by Bridgelux provides performance assurance. Slight cosmetic changes that do not affect form, fit, or function may occur as Bridgelux continues product optimization.

STANDARD TEST CONDITIONS

Unless otherwise stated, array testing is performed at the nominal drive current.

About Bridgelux: We Build Light That Transforms

At Bridgelux, we help companies, industries and people experience the power and possibility of light. Since 2002, we've designed LED solutions that are high performing, energy efficient, cost effective and easy to integrate. Our focus is on light's impact on human behavior, delivering products that create better environments, experiences and returns—both experiential and financial. And our patented technology drives new platforms for commercial and industrial luminaires.

For more information about the company, please visit
bridgelux.com
twitter.com/Bridgelux
facebook.com/Bridgelux
WeChat ID: BridgeluxInChina



101 Portola Avenue
Livermore, CA 94551
Tel (925) 583-8400
Fax (925) 583-8410
www.bridgelux.com

© 2016 Bridgelux, Inc. All rights reserved 2016. Product specifications are subject to change without notice. Bridgelux, the Bridgelux stylized logo design and Vero are registered trademarks, and Decor Series is a trademark of Bridgelux, Inc. All other trademarks are the property of their respective owners.

Bridgelux Vero 18 Array Series Product Data Sheet DS32 Rev. K (06/2016)