

Linear Power MOSFET IXTK46N50L With Extended FBSOA IXTX46N50L

N-Channel Enhancement Mode

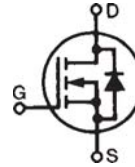

$$V_{DSS} = 500 \text{ V}$$

$$I_{D25} = 46 \text{ A}$$

$$R_{DS(on)} \leq 0.16 \text{ } \Omega$$

Symbol	Test Conditions	Maximum Ratings	
V_{DSS}	$T_J = 25^\circ\text{C}$ to 150°C	500	V
V_{DGR}	$T_J = 25^\circ\text{C}$ to 150°C ; $R_{GS} = 1 \text{ M}\Omega$	500	V
V_{GS}	Continuous	± 30	V
V_{GSM}	Transient	± 40	V
I_{D25}	$T_C = 25^\circ\text{C}$	46	A
I_{DM}	$T_C = 25^\circ\text{C}$, pulse width limited by T_{JM}	100	A
I_{AR}	$T_C = 25^\circ\text{C}$	46	A
E_{AR}	$T_C = 25^\circ\text{C}$	60	mJ
E_{AS}		1.5	J
P_D	$T_C = 25^\circ\text{C}$	700	W
T_J		-55 to +150	$^\circ\text{C}$
T_{JM}		150	$^\circ\text{C}$
T_{stg}		-55 to +150	$^\circ\text{C}$
T_L	1.6 mm (0.063 in) from case for 10 s	300	$^\circ\text{C}$
T_{SOLD}	Plastic body for 10 s	260	$^\circ\text{C}$
M_d	Mounting torque (TO-264)	1.13/10	Nm/lb.in.
F_c	Mounting force (PLUS247™)	20...120/4.5...27	N/lb.
Weight	PLUS247	6	g
	TO-264	10	g

TO-264 (IXTK)

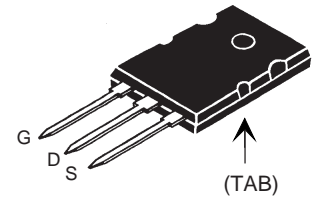

PLUS247 (IXTX)

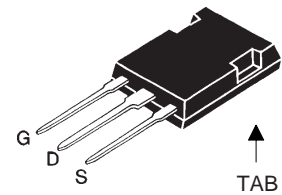

G = Gate
S = Source
D = Drain
TAB = Drain

Features

- Designed for linear operation
- International standard package
- Unclamped Inductive switching (UIS) rated
- Molding epoxies meet UL 94 V-0 flammability classification

Applications

- Programmable loads
- Current regulators
- DC-DC converters
- Battery chargers
- DC choppers
- Temperature and lighting controls

Advantages

- Easy to mount
- Space savings
- High power density

Symbol	Test Conditions	Characteristic Values ($T_J = 25^\circ\text{C}$, unless otherwise specified)		
		Min.	Typ.	Max.
BV_{DSS}	$V_{GS} = 0 \text{ V}$, $I_D = 1 \text{ mA}$	500		V
$V_{GS(th)}$	$V_{DS} = V_{GS}$, $I_D = 250 \text{ } \mu\text{A}$	3		V
I_{GSS}	$V_{GS} = \pm 30 \text{ V}$, $V_{DS} = 0 \text{ V}$			$\pm 200 \text{ nA}$
I_{DSS}	$V_{DS} = V_{DSS}$ $V_{GS} = 0 \text{ V}$	$T_J = 25^\circ\text{C}$		50 μA
		$T_J = 125^\circ\text{C}$		1 mA
$R_{DS(on)}$	$V_{GS} = 20 \text{ V}$, $I_D = 0.5 I_{D25}$, Note 1			0.16 Ω

IXYS reserves the right to change limits, test conditions, and dimensions.

Symbol	Test Conditions	Characteristic Values ($T_J = 25^\circ\text{C}$, unless otherwise specified)			
		Min.	Typ.	Max.	
g_{fs}	$V_{DS} = 10\text{ V}$; $I_D = 0.5 \cdot I_{D25}$, Note 1	7	10	13	S
C_{iss}	$V_{GS} = 0\text{ V}$, $V_{DS} = 25\text{ V}$, $f = 1\text{ MHz}$	7000		pF	
C_{oss}		900		pF	
C_{rss}		170		pF	
$t_{d(on)}$	$V_{GS} = 15\text{ V}$, $V_{DS} = 0.5 \cdot V_{DSS}$, $I_D = 0.5 \cdot I_{D25}$ $R_G = 2\ \Omega$ (External),	40		ns	
t_r		50		ns	
$t_{d(off)}$		80		ns	
t_f		42		ns	
$Q_{g(on)}$	$V_{GS} = 15\text{ V}$, $V_{DS} = 0.5 \cdot V_{DSS}$, $I_D = 0.5 \cdot I_{D25}$	260		nC	
Q_{gs}		85		nC	
Q_{gd}		125		nC	
R_{thJC}		0.18		$^\circ\text{C/W}$	
R_{thCS}		0.15		$^\circ\text{C/W}$	

Safe Operating Area Specification

Symbol	Test Conditions	Min.	Typ.	Max.
SOA	$V_{DS} = 400\text{ V}$, $I_D = 0.6\text{ A}$, $T_C = 90^\circ\text{C}$	240		W

Source-Drain Diode

Symbol	Test Conditions	Characteristic Values ($T_J = 25^\circ\text{C}$, unless otherwise specified)			
		Min.	Typ.	Max.	
I_S	$V_{GS} = 0\text{ V}$			46	A
I_{SM}	Repetitive; pulse width limited by T_{JM}			100	A
V_{SD}	$I_F = I_S$, $V_{GS} = 0\text{ V}$, Note 1			1.5	V
t_{rr}	$I_F = I_S$, $-di/dt = 100\text{ A}/\mu\text{s}$, $V_R = 100\text{ V}$		600		ns

Note 1: Pulse test, $t < 300\ \mu\text{s}$, duty cycle, $d \leq 2\%$

PRELIMINARY TECHNICAL INFORMATION

The product presented herein is under development. The Technical Specifications offered are derived from data gathered during objective characterizations of preliminary engineering lots; but also may yet contain some information supplied during a pre-production design evaluation. IXYS reserves the right to change limits, test conditions, and dimensions without notice.

TO-264 (IXTK) Outline

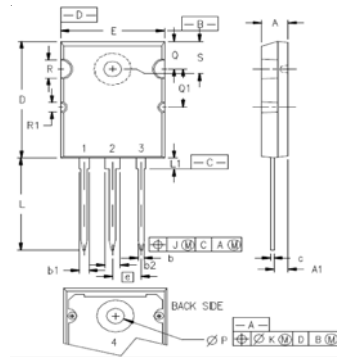

- 1 - GATE
2, 4 - DRAIN (COLLECTOR)
3 - SOURCE (EMITTER)

SYM	INCHES		MILLIMETERS	
	MIN	MAX	MIN	MAX
A	.185	.209	4.70	5.31
A1	.102	.118	2.59	3.00
b	.037	.055	0.94	1.40
b1	.087	.102	2.21	2.59
b2	.110	.126	2.79	3.20
c	.017	.029	0.43	0.74
D	1.007	1.047	25.58	26.59
E	.760	.799	19.30	20.29
e	.215 BSC		5.46 BSC	
J	.000	.010	0.00	0.25
K	.000	.010	0.00	0.25
L	.779	.842	19.79	21.39
L1	.087	.102	2.21	2.59
ØP	.122	.138	3.10	3.51
Q	.240	.256	6.10	6.50
Q1	.330	.346	8.38	8.79
ØR	.155	.187	3.94	4.75
ØR1	.085	.093	2.16	2.36
S	.243	.253	6.17	6.43

PLUS247™ (IXTX) Outline

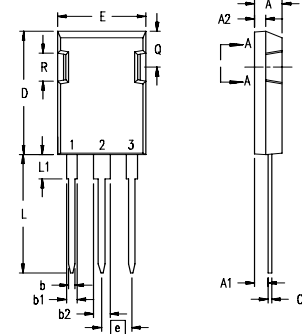

- Terminals: 1 - Gate
2 - Drain (Collector)
3 - Source (Emitter)
4 - Drain (Collector)

Dim.	Millimeter		Inches	
	Min.	Max.	Min.	Max.
A	4.83	5.21	.190	.205
A ₁	2.29	2.54	.090	.100
A ₂	1.91	2.16	.075	.085
b	1.14	1.40	.045	.055
b ₁	1.91	2.13	.075	.084
b ₂	2.92	3.12	.115	.123
C	0.61	0.80	.024	.031
D	20.80	21.34	.819	.840
E	15.75	16.13	.620	.635
e	5.45 BSC		.215 BSC	
L	19.81	20.32	.780	.800
L1	3.81	4.32	.150	.170
Q	5.59	6.20	.220	0.244
R	4.32	4.83	.170	.190

IXYS reserves the right to change limits, test conditions, and dimensions.

IXYS MOSFETs and IGBTs are covered by one or more of the following U.S. patents:

4,835,592	4,931,844	5,049,961	5,237,481	6,162,665	6,404,065 B1	6,683,344	6,727,585	7,005,734 B2	7,157,338 B2
4,850,072	5,017,508	5,063,307	5,381,025	6,259,123 B1	6,534,343	6,710,405 B2	6,759,692	7,063,975 B2	
4,881,106	5,034,796	5,187,117	5,486,715	6,306,728 B1	6,583,505	6,710,463	6,771,478 B2	7,071,537	

**Fig. 1. Output Characteristics
@ 25°C**

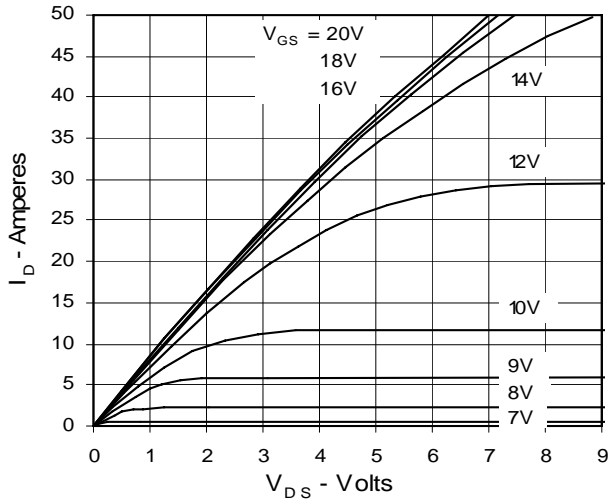

**Fig. 2. Extended Output Characteristics
@ 25°C**

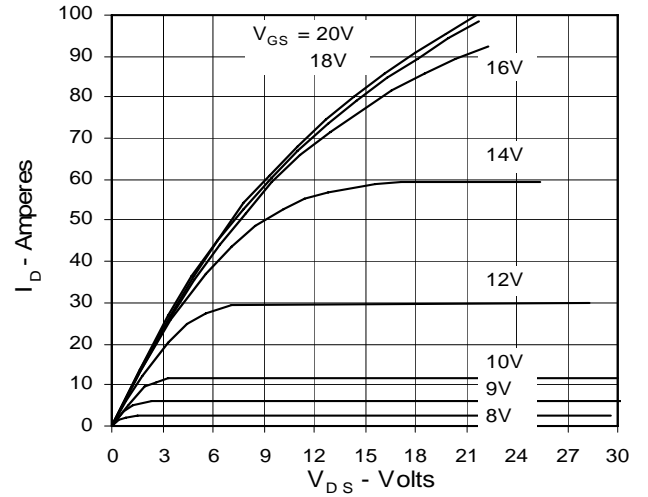

**Fig. 3. Output Characteristics
@ 125°C**

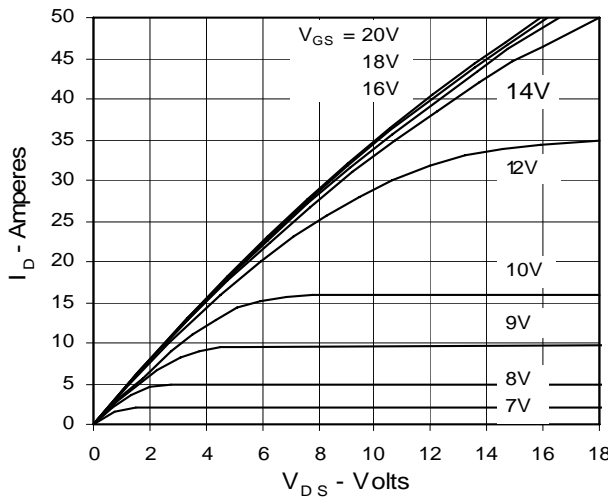

**Fig. 4. $R_{DS(on)}$ Normalized to 0.5 I_{D25} Value
vs. Junction Temperature**

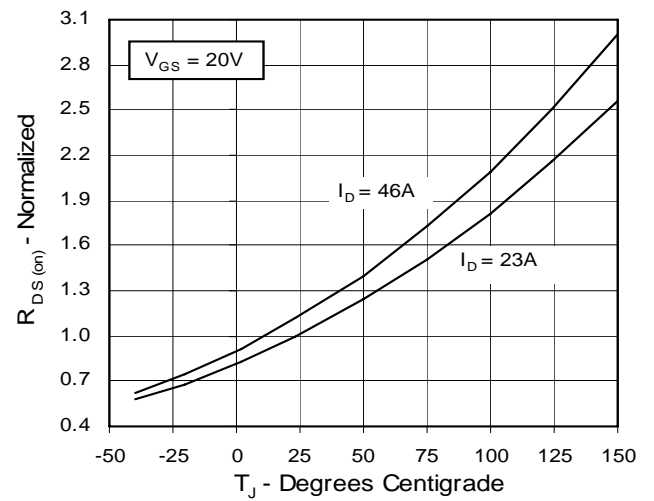

**Fig. 5. $R_{DS(on)}$ Normalized to
0.5 I_{D25} Value vs. I_D**

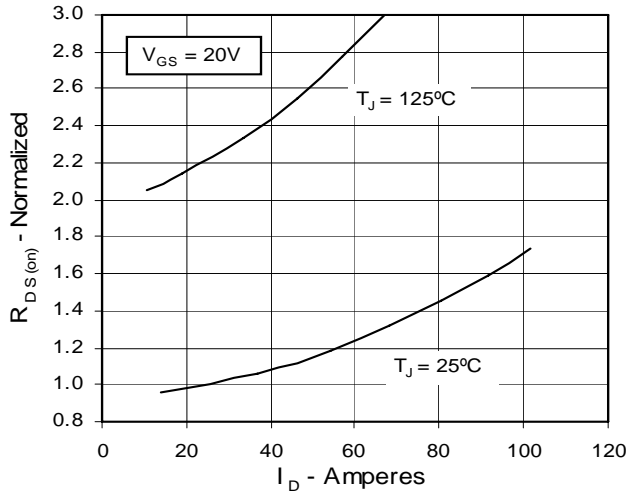

**Fig. 6. Drain Current vs. Case
Temperature**

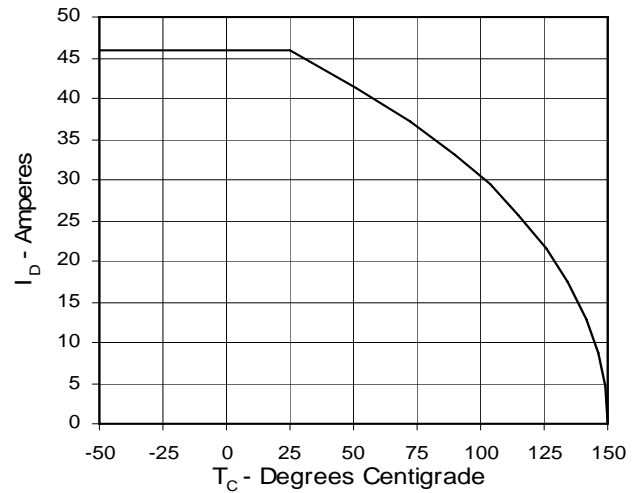

Fig. 7. Input Admittance

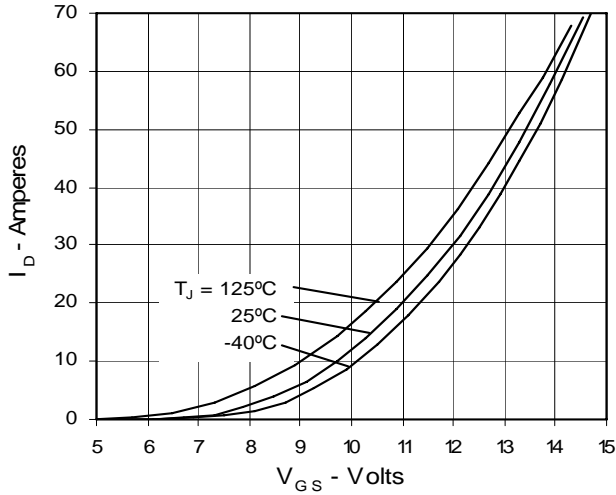

Fig. 8. Transconductance

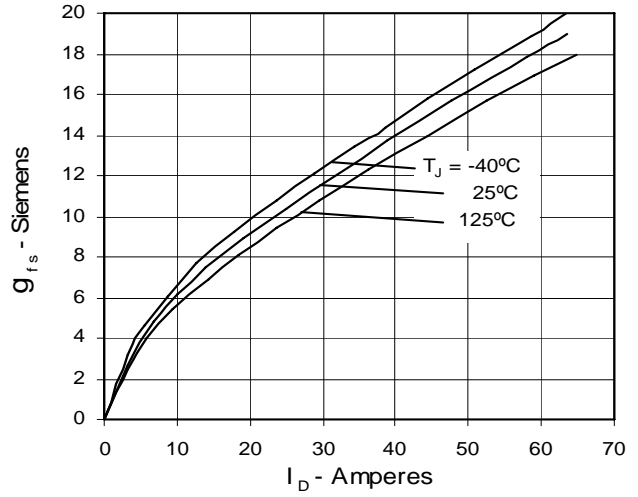

Fig. 9. Source Current vs. Source-To-Drain Voltage

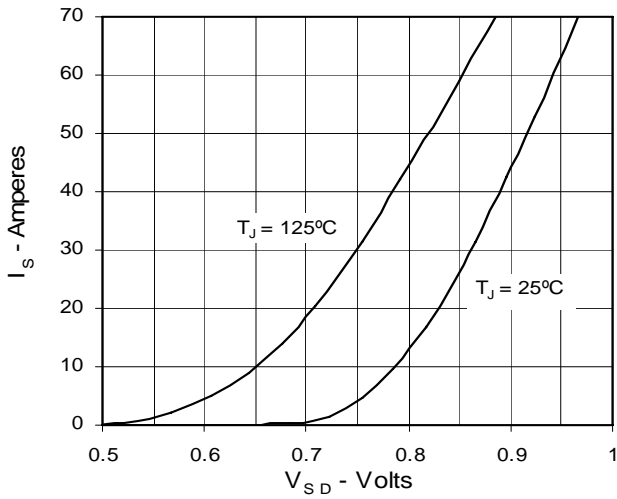

Fig. 10. Gate Charge

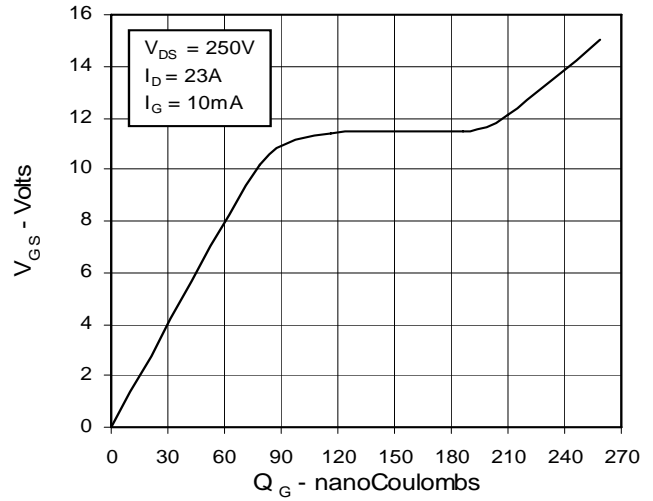

Fig. 11. Capacitance

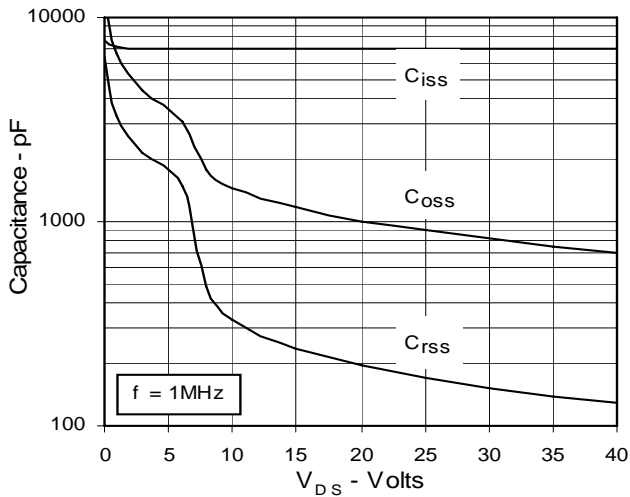

Fig. 12. Forward-Bias Safe Operating Area @ $T_C = 25^\circ\text{C}$

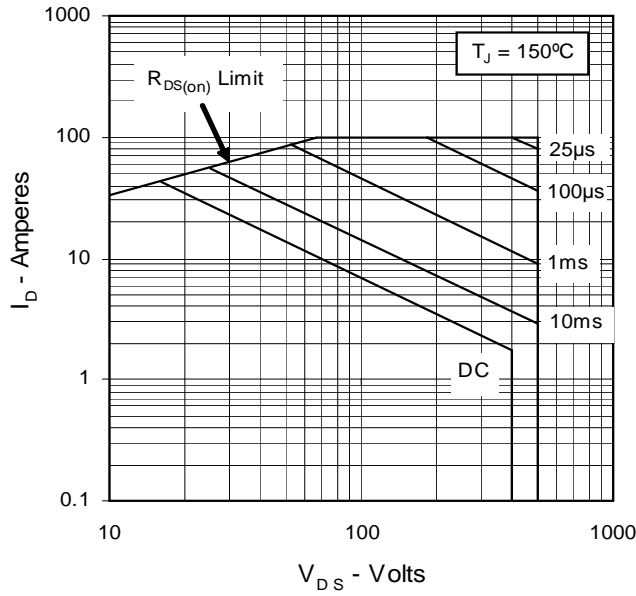

Fig. 13. Forward-Bias Safe Operating Area @ $T_C = 90^\circ\text{C}$

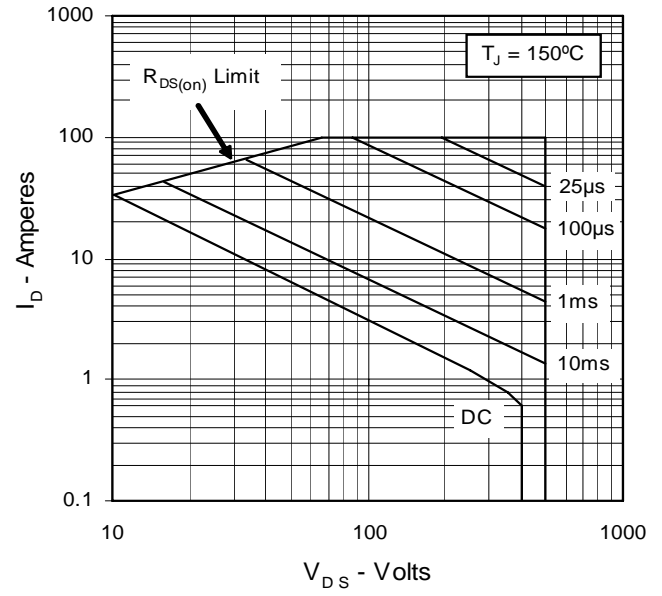

Fig. 14. Maximum Transient Thermal Impedance

