

High Radiant Flux Density 400nm Violet LED Emitter **LZC-00UA00**



Key Features

- Ultra-bright, compact 12-die, 400nm Violet LED
- Very high Radiant Flux density
- Small high density foot print, 9.0mm x 9.0mm
- Surface mount ceramic package with integrated glass lens
- Exceptionally low Thermal Resistance (0.7°C/W)
- Electrically neutral thermal slug
- Autoclave complaint (JEDEC JESD22-A102-C)
- JEDEC Level 1 for Moisture Sensitivity Level
- Lead (Pb) free and RoHS compliant
- Reflow solderable (up to 6 cycles)
- Emitter available on MCPCB (optional)

Typical Applications

- Curing
- Sterilization
- Medical
- Currency Verification
- Fluorescence Microscopy
- Inspection of dyes, rodent and animal contamination,
- Leak detection
- Forensics

Description

The LZC-series emitter is rated for 40W power handling in an ultra compact package. With a small 9.0mm x 9.0mm footprint, this package provides exceptional radiant flux density. The patented design has unparalleled thermal and optical performance. The high quality materials used in the package are chosen to optimize Radiant Flux and minimize stresses which results in monumental reliability and radiant flux maintenance. The robust product design thrives in outdoor applications with high ambient temperatures and high humidity.

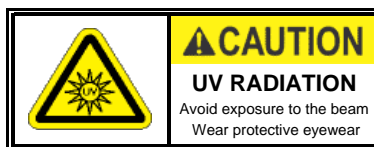

Part number options

Base part number

Part number	Description
LZC-00UA00-xxxx	LZC emitter
LZC-70UA00-xxxx	LZC emitter on 1 channel 1x12 Star MCPCB
LZC-C0UA00-xxxx	LZC emitter on 2 channel 2x6 Star MCPCB

Bin kit option codes

Single wavelength bin (5nm range)

Kit number suffix	Min flux Bin	Color Bin Range	Description
00U4	W	U4	W minimum flux; wavelength U4 bin only
00U5	X	U5	X minimum flux; wavelength U5 bin only
00U6	X	U6	X minimum flux; wavelength U6 bin only
00U7	X	U7	X minimum flux; wavelength U7 bin only
00U8	X	U8	X minimum flux; wavelength U8 bin only

Radiant Flux Bins

Table 1:

Bin Code	Minimum Radiant Flux (Φ) @ $I_F = 700\text{mA}$ ^[1,2] (W)	Maximum Radiant Flux (Φ) @ $I_F = 700\text{mA}$ ^[1,2] (W)
W	7.50	9.50
X	9.50	12.00
Y	12.00	15.00

Notes for Table 1:

1. Radiant flux performance guaranteed within published operating conditions. LED Engin maintains a tolerance of $\pm 10\%$ on flux measurements.
2. Future products will have even higher levels of radiant flux performance. Contact LED Engin Sales for updated information.

Peak Wavelength Bins

Table 2:

Bin Code	Minimum Peak Wavelength (λ_P) @ $I_F = 700\text{mA}$ ^[1] (nm)	Maximum Peak Wavelength (λ_P) @ $I_F = 700\text{mA}$ ^[1] (nm)
U4	385	390
U5	390	395
U6	395	400
U7	400	405
U8	405	410

Notes for Table 2:

1. LED Engin maintains a tolerance of $\pm 2.0\text{nm}$ on peak wavelength measurements.

Forward Voltage Bins

Table 3:

Bin Code	Minimum Forward Voltage (V_F) @ $I_F = 700\text{mA}$ ^[1,2] (V)	Maximum Forward Voltage (V_F) @ $I_F = 700\text{mA}$ ^[1,2] (V)
0	41.28	47.04

Notes for Table 3:

1. Forward Voltage is binned with all 12 LED dice connected in series.
2. LED Engin maintains a tolerance of $\pm 0.48\text{V}$ for forward voltage measurements ($\pm 0.04\text{V}$ per die).

Absolute Maximum Ratings

Table 4:

Parameter	Symbol	Value	Unit
DC Forward Current ^[1]	I_F	1000	mA
Peak Pulsed Forward Current ^[2]	I_{FP}	1000	mA
Reverse Voltage	V_R	See Note 3	V
Storage Temperature	T_{stg}	-40 ~ +150	°C
Junction Temperature	T_J	125	°C
Soldering Temperature ^[4]	T_{sol}	260	°C
Allowable Reflow Cycles		6	
ESD Sensitivity ^[5]		> 2,000 V HBM Class 2B JESD22-A114-D	

Notes for Table 4:

- Maximum DC forward current (per die) is determined by the overall thermal resistance and ambient temperature. Follow the curves in Figure 10 for current derating.
- Pulse forward current conditions: Pulse Width \leq 10msec and Duty Cycle \leq 10%.
- LEDs are not designed to be reverse biased.
- Solder conditions per JEDEC 020D. See Reflow Soldering Profile Figure 3.
- LED Engin recommends taking reasonable precautions towards possible ESD damages and handling the LZC-00UA00 in an electrostatic protected area (EPA). An EPA may be adequately protected by ESD controls as outlined in ANSI/ESD S6.1.

Optical Characteristics @ $T_C = 25^\circ\text{C}$

Table 5:

Parameter	Symbol	Typical			Unit
		385-390nm	390-400nm	400-410nm	
Radiant Flux (@ $I_F = 700\text{mA}$)	Φ	8.50	10.10	11.30	W
Radiant Flux (@ $I_F = 1000\text{mA}$)	Φ	11.90	14.10	15.80	W
Peak Wavelength ^[1]	λ_p	385	395	405	nm
Viewing Angle ^[2]	$2\theta_{1/2}$		95		Degrees
Total Included Angle ^[3]	$\theta_{0.9V}$		115		Degrees

Notes for Table 5:

- When operating the VIOLET LED, observe IEC 60825-1 class 3B rating. Avoid exposure to the beam.
- Viewing Angle is the off axis angle from emitter centerline where the luminous intensity is $\frac{1}{2}$ of the peak value.
- Total Included Angle is the total angle that includes 90% of the total luminous flux.

Electrical Characteristics @ $T_C = 25^\circ\text{C}$

Table 6:

Parameter	Symbol	Typical	Unit
Forward Voltage (@ $I_F = 700\text{mA}$) ^[1]	V_F	44	V
Temperature Coefficient of Forward Voltage ^[1]	$\Delta V_F / \Delta T_J$	-14.2	mV/°C
Thermal Resistance (Junction to Case)	$R\theta_{J-C}$	0.7	°C/W

Notes for Table 6:

- Typical values for Forward Voltage and Temperature Coefficient of Forward Voltage is shown for with all 12 LED dice connected in series.

IPC/JEDEC Moisture Sensitivity Level

Table 7 - IPC/JEDEC J-STD-20D.1 MSL Classification:

Level	Soak Requirements					
	Floor Life		Standard		Accelerated	
	Time	Conditions	Time (hrs)	Conditions	Time (hrs)	Conditions
1	Unlimited	≤ 30°C/ 85% RH	168 +5/-0	85°C/ 85% RH	n/a	n/a

Notes for Table 7:

1. The standard soak time includes a default value of 24 hours for semiconductor manufacturer's exposure time (MET) between bake and bag and includes the maximum time allowed out of the bag at the distributor's facility.

Average Radiant Flux Maintenance Projections

Lumen maintenance generally describes the ability of an emitter to retain its output over time. The useful lifetime for power LEDs is also defined as Radiant Flux Maintenance, with the percentage of the original light output remaining at a defined time period.

Based on long-term WHTOL testing, LED Engin projects that the LZ Series will deliver, on average, 70% Radiant Flux Maintenance (RP70%) at 20,000 hours of operation at a forward current of 700 mA per die. This projection is based on constant current operation with junction temperature maintained at or below 80°C.

Recommended Solder Mask Layout (mm)

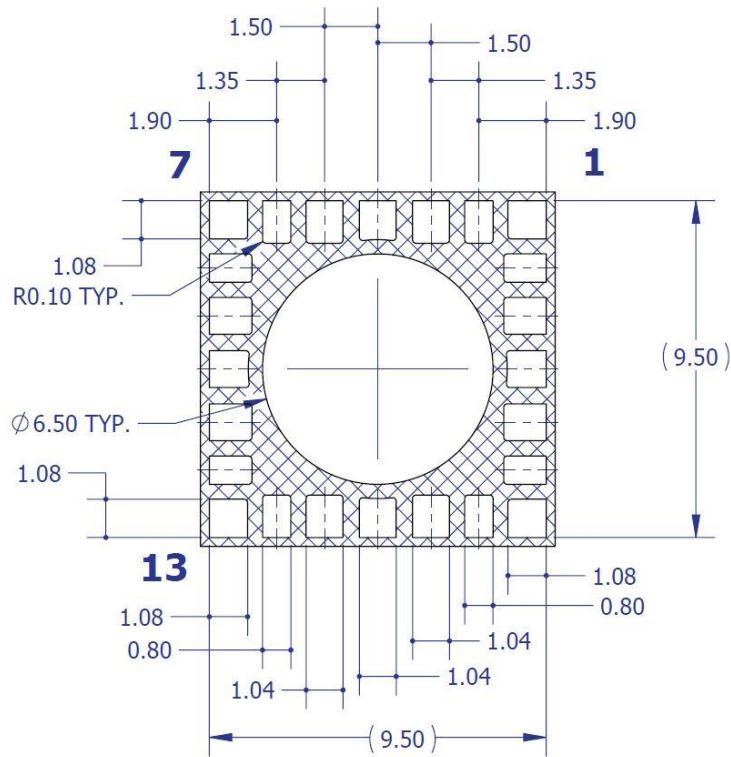

Figure 2b: Recommended solder mask opening (hatched area) for anode, cathode, and thermal pad.

Note for Figure 2b:

- 1. Unless otherwise noted, the tolerance = ± 0.20 mm.

Reflow Soldering Profile

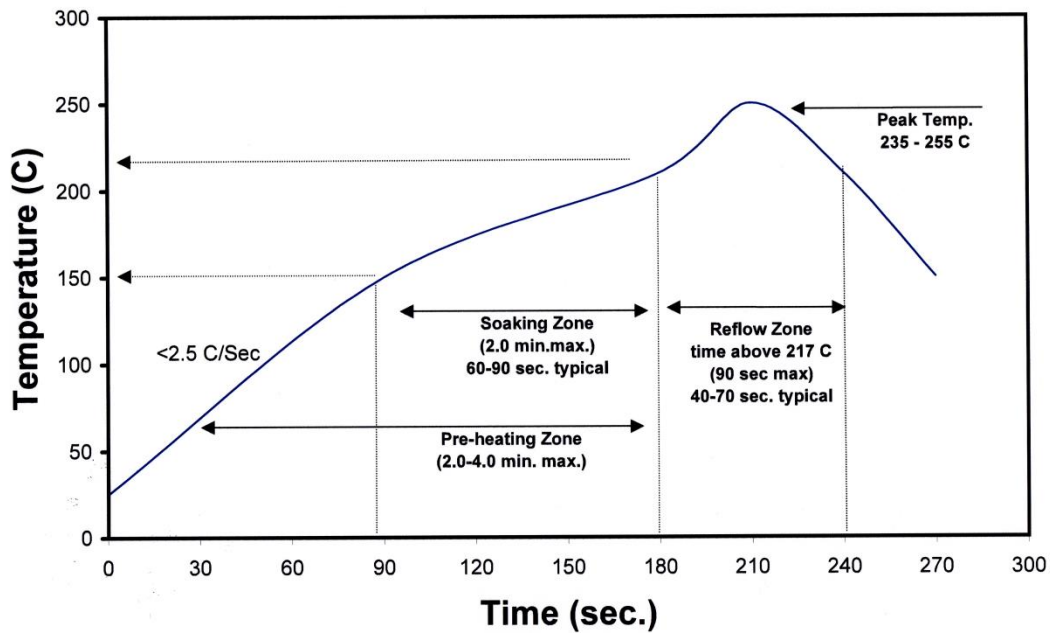

Figure 3: Reflow soldering profile for lead free soldering.

Typical Radiation Pattern

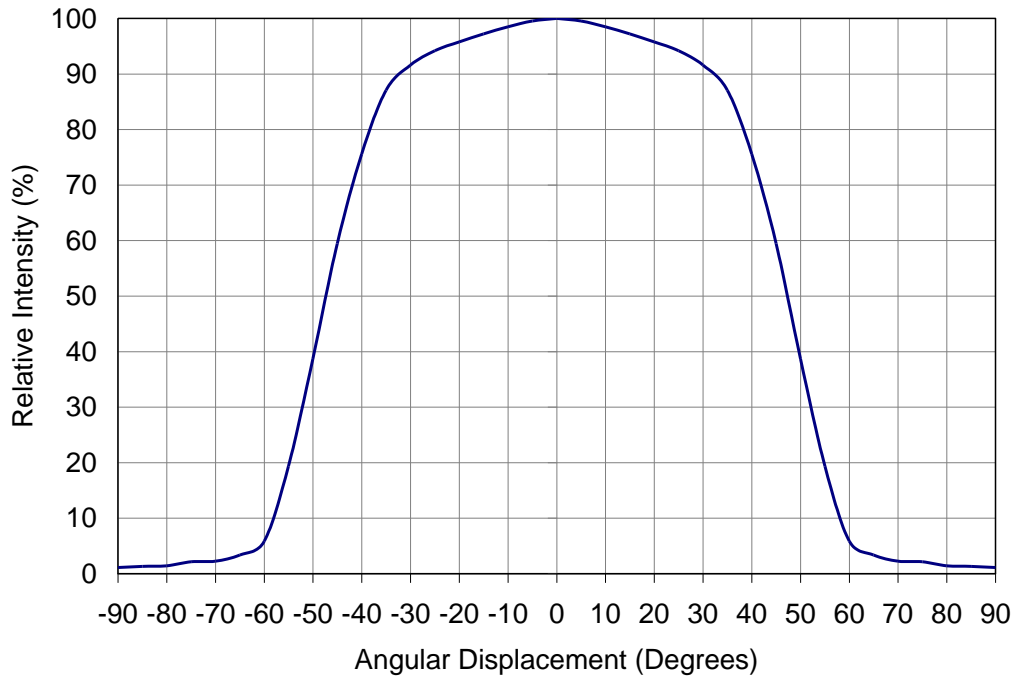

Figure 4: Typical representative spatial radiation pattern.

Typical Relative Spectral Power Distribution

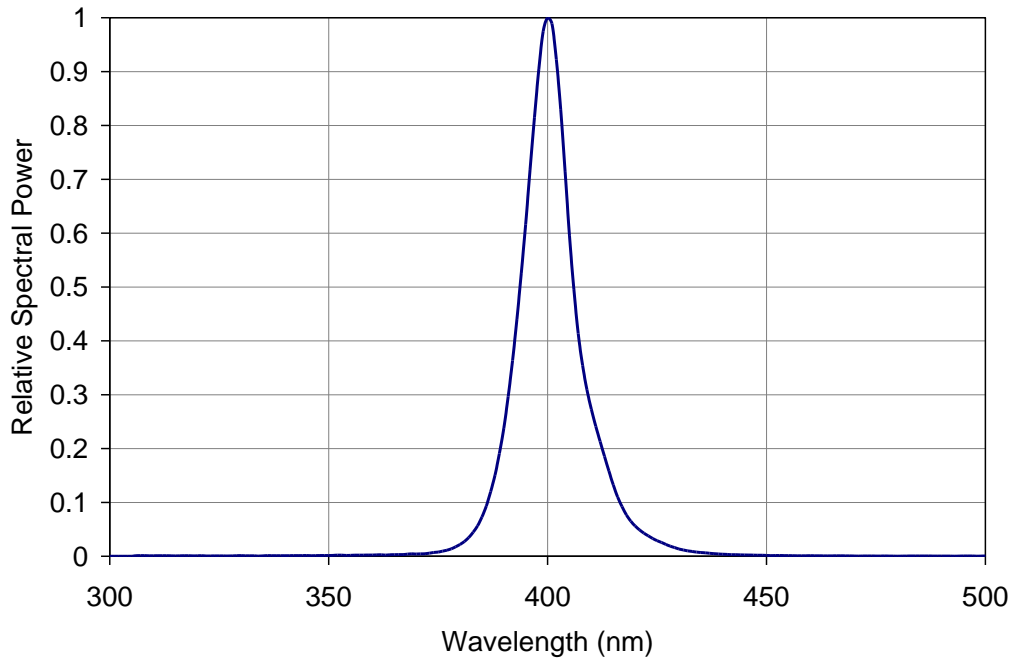

Figure 5: Relative spectral power vs. wavelength @ T_c = 25°C.

Typical Relative Dominant Wavelength Shift over Temperature

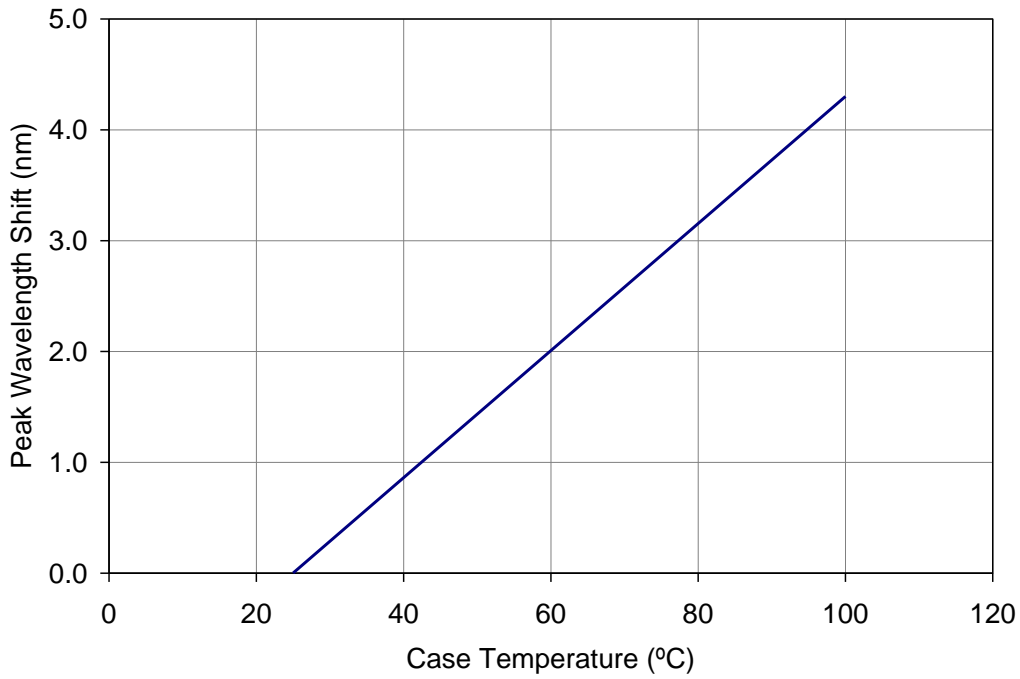

Figure 6: Typical dominant wavelength shift vs. case temperature.

Typical Relative Radiant Flux

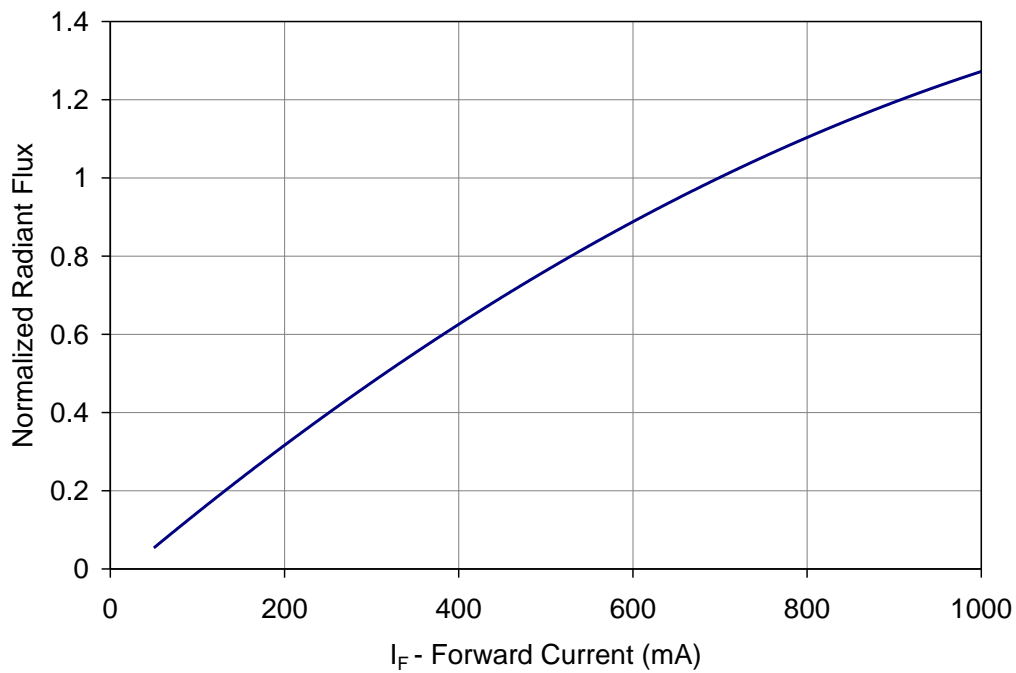

Figure 7: Typical relative Radiant Flux vs. forward current @ T_c = 25°C.

Typical Normalized Radiant Flux over Temperature

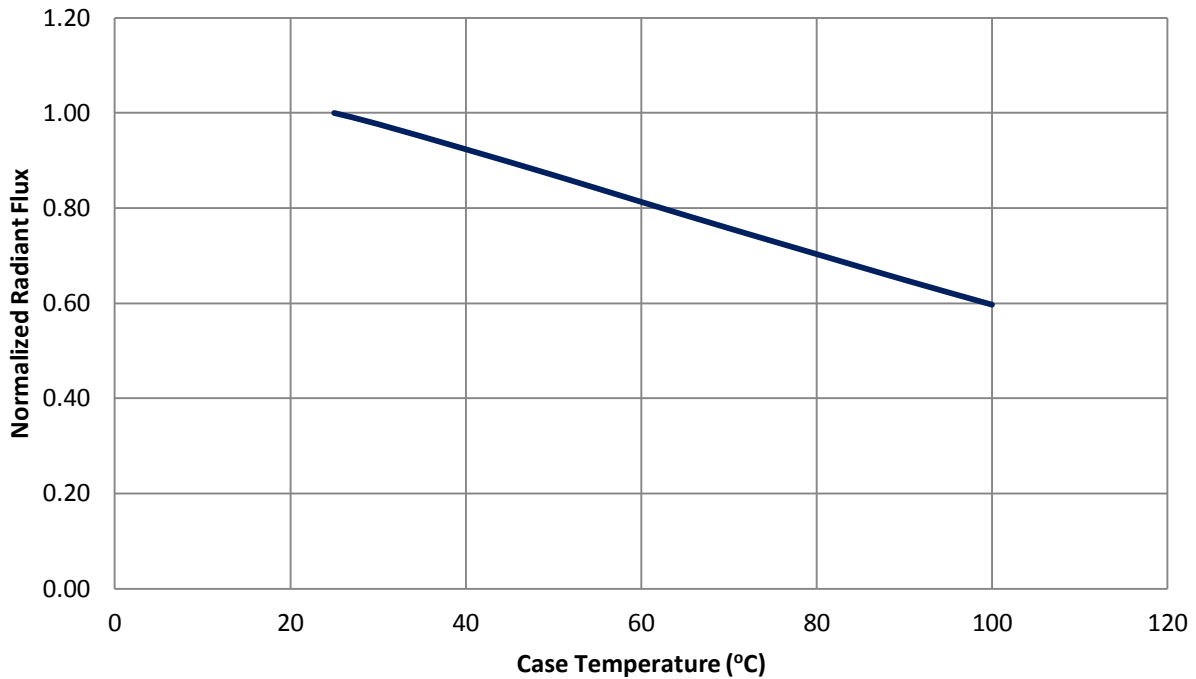

Figure 8: Typical normalized radiant flux vs. case temperature @700mA

Typical Forward Current Characteristics

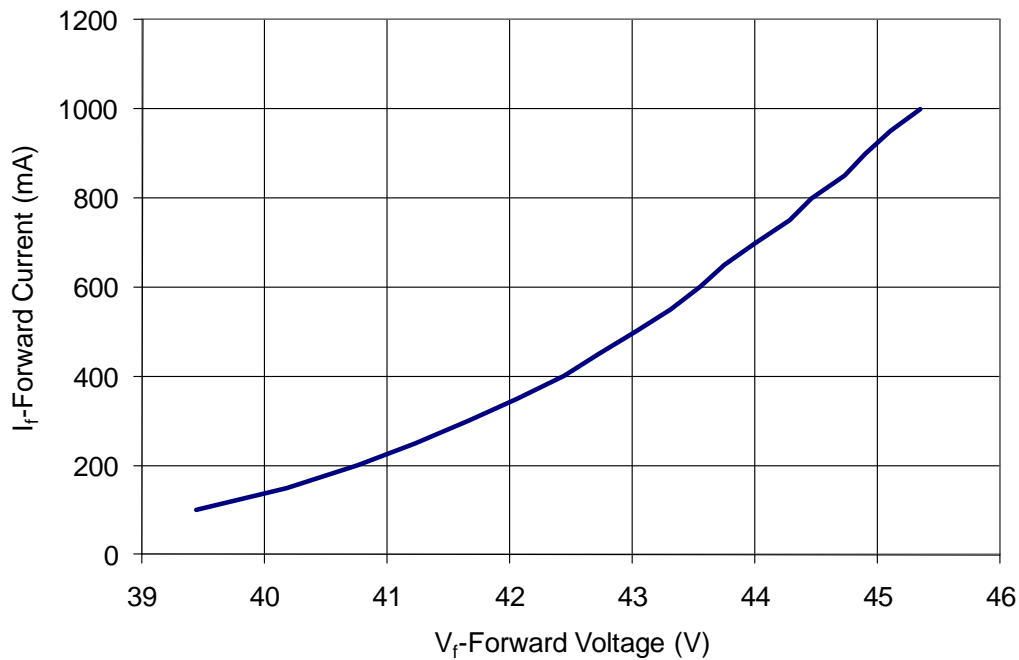

Figure 9: Typical forward current vs. forward voltage @ T_c = 25°C.

Note for Figure 9:

1. Forward Voltage curve is assumes that all twelve LED dice are connected in series.

Current De-rating

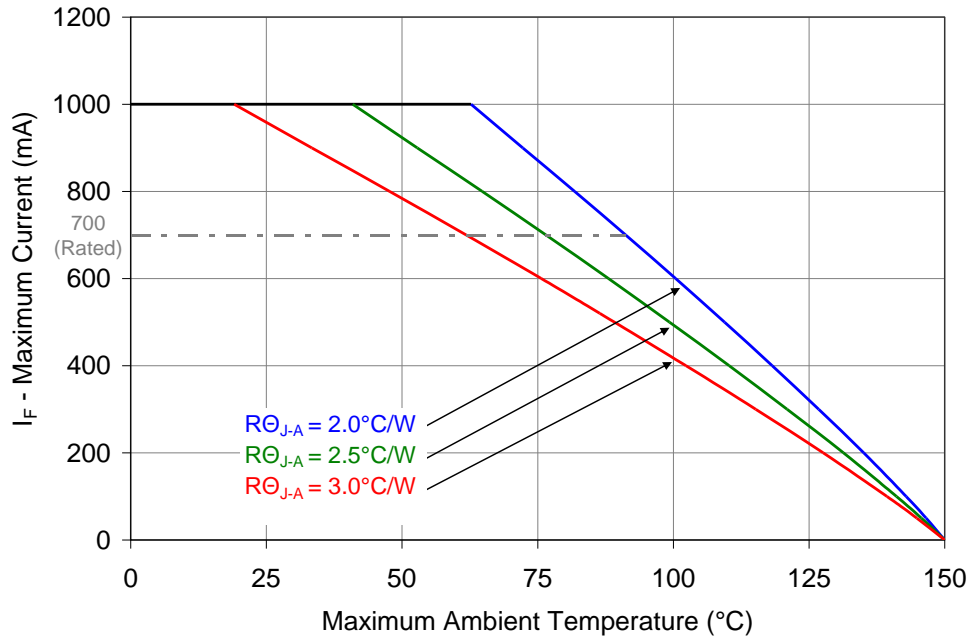

Figure 10: Maximum forward current vs. ambient temperature based on $T_{J(\text{MAX})} = 125^{\circ}\text{C}$.

Notes for Figure 10:

1. Maximum current assumes that all four LED dice are operating concurrently at the same current.
2. $R_{\theta_{J-C}}$ [Junction to Case Thermal Resistance] for the LZC-series is typically 0.7°C/W .
3. $R_{\theta_{J-A}}$ [Junction to Ambient Thermal Resistance] = $R_{\theta_{J-C}} + R_{\theta_{C-A}}$ [Case to Ambient Thermal Resistance].

Emitter Tape and Reel Specifications (mm)

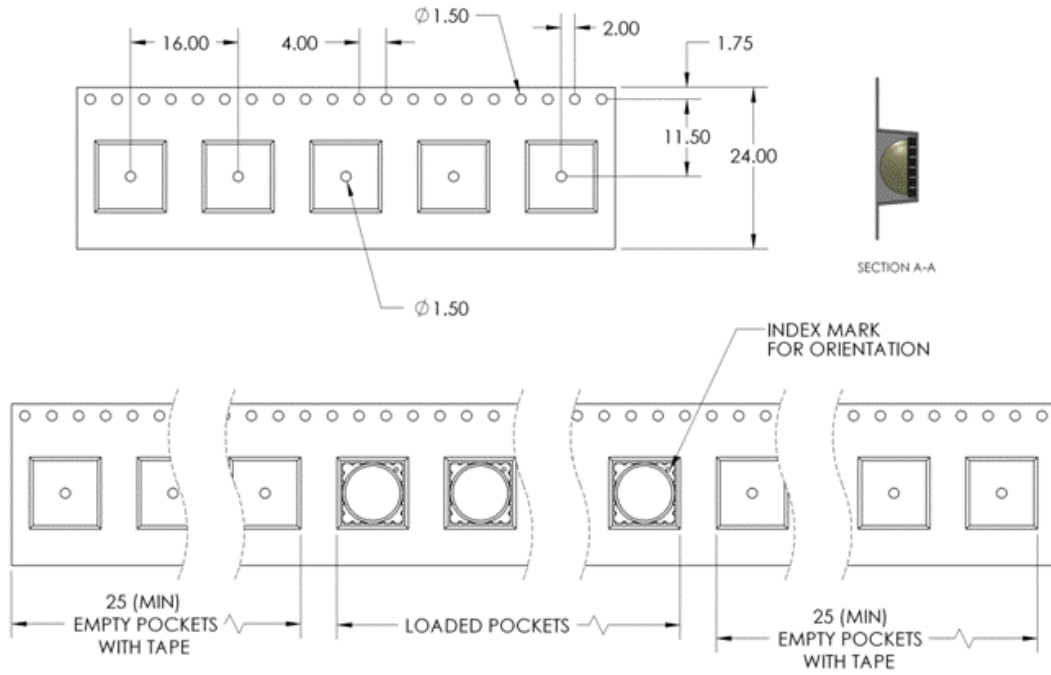

Figure 11: Emitter carrier tape specifications (mm).

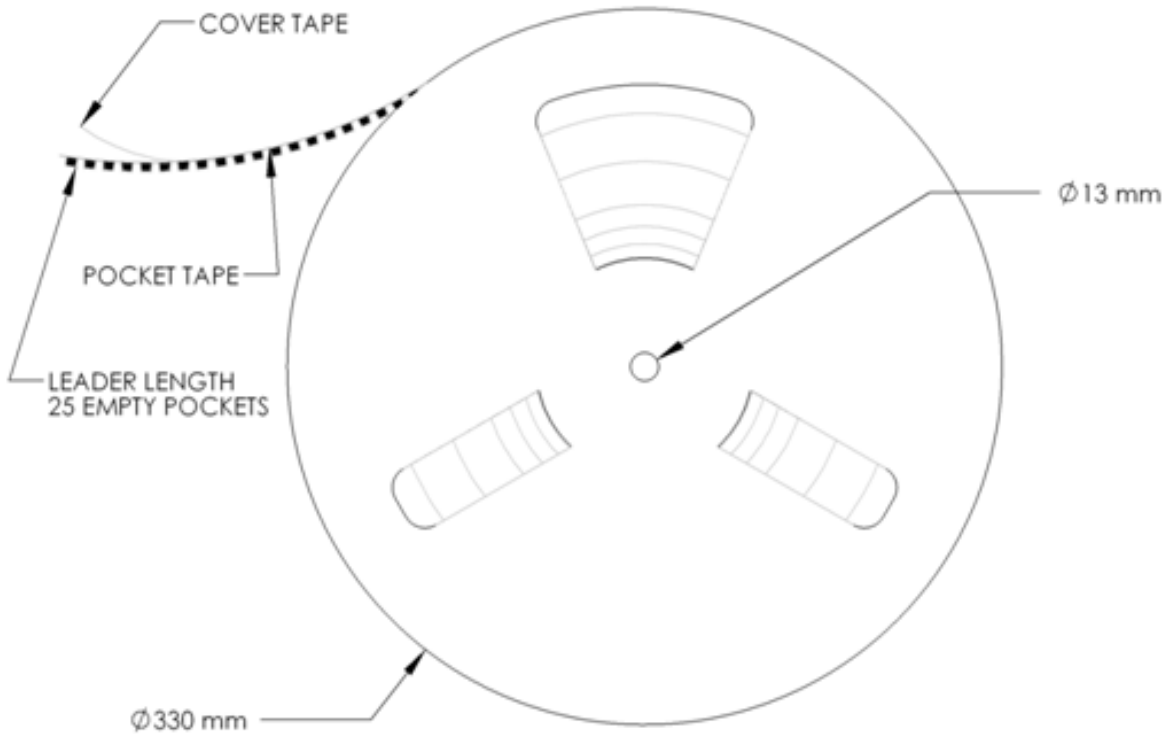

Figure 12: Emitter Reel specifications (mm).

LZC MCPCB Family

Part number	Type of MCPCB	Diameter (mm)	Emitter + MCPCB Thermal Resistance (°C /W)	Typical V _f (V)	Typical I _f (mA)
LZC-7xxxxx	1-channel	28.3	0.7 + 0.6 = 1.3	44.0	700
LZC-Cxxxxx	2-channel	28.3	0.7 + 0.6 = 1.3	22.0	2 x 700

Mechanical Mounting of MCPCB

- MCPCB bending should be avoided as it will cause mechanical stress on the emitter, which could lead to substrate cracking and subsequently LED dies cracking.
- To avoid MCPCB bending:
 - Special attention needs to be paid to the flatness of the heat sink surface and the torque on the screws.
 - Care must be taken when securing the board to the heat sink. This can be done by tightening three M3 screws (or #4-40) in steps and not all the way through at once. Using fewer than three screws will increase the likelihood of board bending.
 - It is recommended to always use plastics washers in combinations with the three screws.
 - If non-taped holes are used with self-tapping screws, it is advised to back out the screws slightly after tightening (with controlled torque) and then re-tighten the screws again.

Thermal interface material

- To properly transfer heat from LED emitter to heat sink, a thermally conductive material is required when mounting the MCPCB on to the heat sink.
- There are several varieties of such material: thermal paste, thermal pads, phase change materials and thermal epoxies. An example of such material is Electrolube EHTC.
- It is critical to verify the material's thermal resistance to be sufficient for the selected emitter and its operating conditions.

Wire soldering

- To ease soldering wire to MCPCB process, it is advised to preheat the MCPCB on a hot plate of 125-150°C. Subsequently, apply the solder and additional heat from the solder iron will initiate a good solder reflow. It is recommended to use a solder iron of more than 60W.
- It is advised to use lead-free, no-clean solder. For example: SN-96.5 AG-3.0 CU 0.5 #58/275 from Kester (pn: 24-7068-7601)

LZC-7xxxxx

Emitter on 1-channel MCPCB Dimensions (mm)

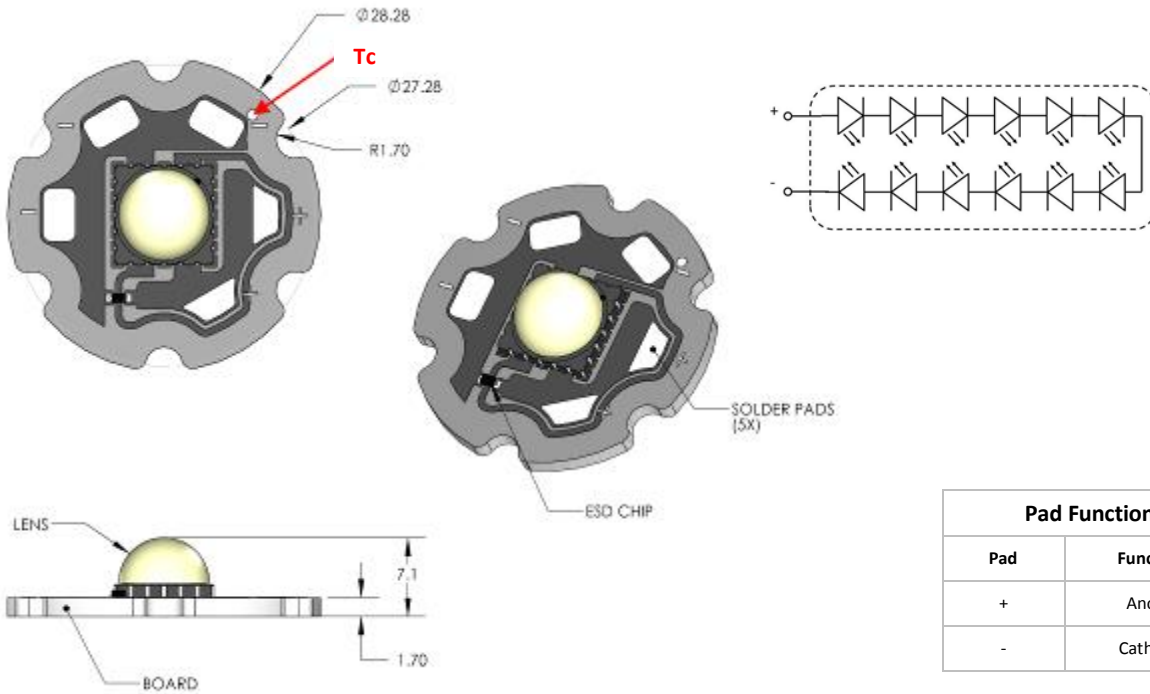

Pad Function	
Pad	Function
+	Anode
-	Cathode

Note for Figure 1:

- Unless otherwise noted, the tolerance = ± 0.2 mm.
- Slots in MCPCB are for M3 or #4-40 mounting screws.
- LED Engin recommends plastic washers to electrically insulate screws from solder pads and electrical traces.
- Electrical connection pads on MCPCB are labeled "+" for Anode and "-" for Cathode.
- LED Engin recommends using thermal interface material when attaching the MCPCB to a heatsink.
- The thermal resistance of the MCPCB is: θ_{JC-B} 0.6°C/W

Components used

MCPCB: HT04503 (Bergquist)
 ESD chips: BZX585-C51 (NPX, for 12 LED dies in series)

LZC-Cxxxxx

Emitter on 2-channel MCPCB Dimensions (mm)

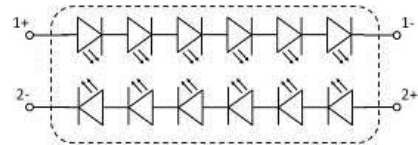
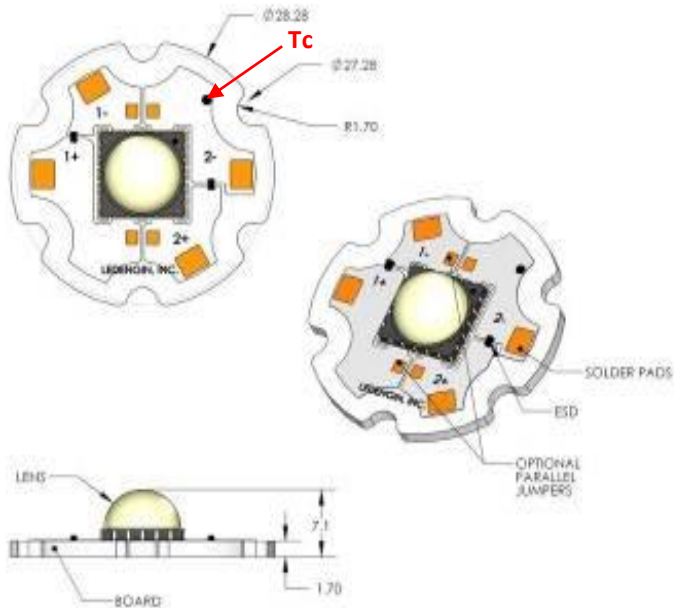

Pad Function	
Pad	Function
1+	Anode Ch1
1-	Cathode Ch1
2+	Anode Ch2
2-	Cathode Ch2

Note for Figure 1:

- Unless otherwise noted, the tolerance = ± 0.2 mm.
- Slots in MCPCB are for M3 or #4-40 mounting screws.
- LED Engin recommends plastic washers to electrically insulate screws from solder pads and electrical traces.
- Electrical connection pads on MCPCB are labeled "+" for Anode and "-" for Cathode.
- LED Engin recommends thermal interface material when attaching the MCPCB to a heatsink.
- The thermal resistance of the MCPCB is: $R_{\theta C-B}$ 0.6°C/W

Components used

MCPCB: HT04503 (Bergquist)
 ESD chips: BZT52C36LP (NPX, for 6 LED dies in series)

Company Information

LED Engin, Inc., based in California's Silicon Valley, specializes in ultra-bright, ultra compact solid state lighting solutions allowing lighting designers & engineers the freedom to create uncompromised yet energy efficient lighting experiences. The LuxiGen™ Platform — an emitter and lens combination or integrated module solution, delivers superior flexibility in light output, ranging from 3W to 90W, a wide spectrum of available colors, including whites, multi-color and UV, and the ability to deliver upwards of 5,000 high quality lumens to a target. The small size combined with powerful output allows for a previously unobtainable freedom of design wherever high-flux density, directional light is required. LED Engin's packaging technologies lead the industry with products that feature lowest thermal resistance, highest flux density and consummate reliability, enabling compact and efficient solid state lighting solutions.

LED Engin is committed to providing products that conserve natural resources and reduce greenhouse emissions.

LED Engin reserves the right to make changes to improve performance without notice.

Please contact sales@ledengin.com or (408) 922-7200 for more information.