

**500mA Battery Charger and 300mA LDO Regulator for Portable Systems**

**General Description**

The AAT2557 is a fully integrated 500mA battery charger and a 300mA low dropout (LDO) linear regulator. The input voltage range is 4V to 6.5V for the battery charger and 2.7V to 5.5V for the linear regulator, making it ideal for applications operating with single-cell lithium-ion/polymer batteries.

The battery charger is a complete constant current/constant voltage linear charger. It offers an integrated pass device, reverse blocking protection, high accuracy current and voltage regulation, charge status, and charge termination. The charging current is programmable via external resistor from 15mA to 500mA. In addition to these standard features, the device offers over-voltage, current limit, and thermal protection.

The linear regulator is designed for fast transient response and good power supply ripple rejection. Capable of up to 300mA load current, it includes short-circuit protection and thermal shutdown.

The AAT2557 is available in a Pb-free, thermally-enhanced TSOPJW-14 package and is rated over the -40°C to +85°C temperature range.

**Features**

- Battery Charger:
  - Input Voltage Range: 4V to 6.5V
  - Programmable Charging Current up to 500mA
  - Highly Integrated With
    - Charging Device
    - Reverse Blocking Diode
- Linear Regulator:
  - 300mA Output Current
  - Low Dropout: 400mV at 300mA
  - Fast Line and Load Transient Response
  - High Accuracy:  $\pm 1.5\%$
  - 70 $\mu$ A Quiescent Current
- Short-Circuit, Over-Temperature, and Current Limit Protection
- TSOPJW-14 Package
- -40°C to +85°C Temperature Range

**Applications**

- Bluetooth™ Headsets
- Cellular and DECT Phones
- Handheld Instruments
- MP3 and Portable Music Players
- PDAs and Handheld Computers
- Portable Media Players

**Typical Application**

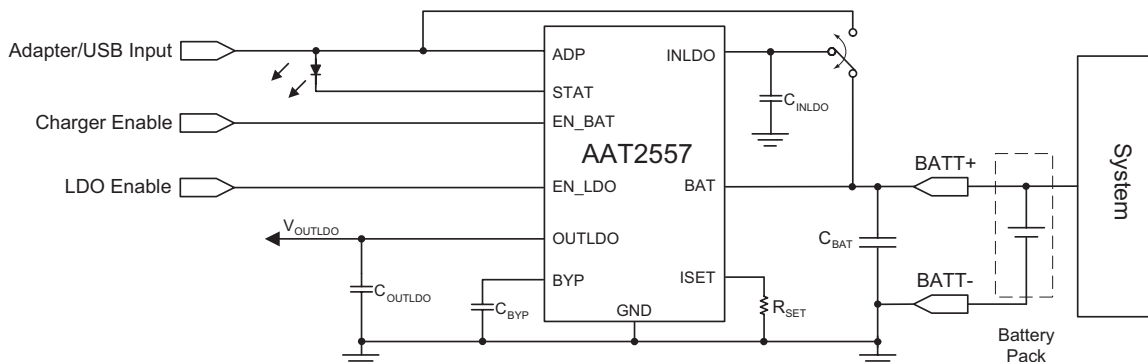

**AAT2557****500mA Battery Charger and 300mA LDO Regulator for Portable Systems****Pin Descriptions**

Pin #	Symbol	Function
1	EN_LDO	Enable pin for the linear regulator. When connected to logic low, the regulator is disabled and consumes less than 1 $\mu$ A of current. When connected to logic high, it resumes normal operation.
2, 8, 12, 13, 14	GND	Ground.
3	BYP	Low noise bypass pin. Connect a 10nF capacitor between this pin and ground to improve AC ripple rejection and reduce noise.
4	EN_BAT	Enable pin for the battery charger. When connected to logic low, the battery charger is disabled and consumes less than 1 $\mu$ A of current. When connected to logic high, the charger resumes normal operation.
5	ISET	Charge current set point. Connect a resistor from this pin to ground. Refer to typical characteristics curves for resistor selection.
6	BAT	Battery charging and sensing.
7	ADP	Input for USB/adaptor charger.
9	STAT	Charge status input. Open drain status output.
10	OUTLDO	Linear regulator output. Connect a 2.2 $\mu$ F capacitor from this pin to ground.
11	INLDO	Linear regulator input voltage. Connect a 1 $\mu$ F or greater capacitor from this pin to ground.

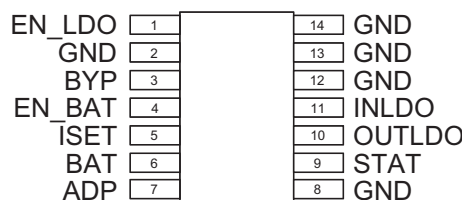
**Pin Configuration****TSOPJW-14  
(Top View)**

**500mA Battery Charger and 300mA LDO Regulator for Portable Systems****Absolute Maximum Ratings<sup>1</sup>**

Symbol	Description	Value	Units
$V_{INLDO}$	Input Voltage to GND	6.0	V
$V_{ADP}$	Adapter Voltage to GND	-0.3 to 7.5	V
$V_{EN}$	EN_LDO, EN_BAT Voltage to GND	-0.3 to 6.0	V
$V_X$	BAT, ISET, STAT Voltage to GND	-0.3 to $V_{ADP} + 0.3$	V
$V_{BYP}$	BYP Voltage to GND	-0.3 to $V_{INLDO} + 0.3$	V
$T_J$	Junction Temperature Range	-40 to 150	°C
$T_A$	Operating Temperature Range	-40 to 85	°C
$T_{LEAD}$	Maximum Soldering Temperature (at leads, 10 sec)	300	°C

**Thermal Information**

Symbol	Description	Value	Units
$P_D$	Maximum Power Dissipation	625	mW
$\theta_{JA}$	Thermal Resistance <sup>2</sup>	160	°C/W

1. Stresses above those listed in Absolute Maximum Ratings may cause permanent damage to the device. Functional operation at conditions other than the operating conditions specified is not implied. Only one Absolute Maximum Rating should be applied at any one time.
2. Mounted on an FR4 board.

**500mA Battery Charger and 300mA LDO Regulator for Portable Systems**

**Electrical Characteristics<sup>1</sup>**

$V_{INLDO} = V_{OUTLDO(NOM)} + 1V$  for  $V_{OUTLDO}$  options greater than 1.5V.  $I_{OUTLDO} = 1mA$ ,  $C_{OUTLDO} = 2.2\mu F$ ,  $C_{INLDO} = 1\mu F$ ,  $C_{BYP} = 10nF$ ,  $T_A = -40^{\circ}C$  to  $+85^{\circ}C$ , unless otherwise noted. Typical values are  $T_A = 25^{\circ}C$ .

Symbol	Description	Conditions	Min	Typ	Max	Units
<b>Linear Regulator</b>						
$V_{OUTLDO}$	Output Voltage Tolerance	$I_{OUTLDO} = 1mA$ to $300mA$	$T_A = 25^{\circ}C$ $T_A = -40^{\circ}C$ to $+85^{\circ}C$	-1.5 -2.5	1.5 2.5	%
$V_{INLDO}$	Input Voltage			$V_{OUTLDO} + V_{DOLDO}^2$	5.5	V
$V_{DOLDO}$	Dropout Voltage <sup>3</sup>	$I_{OUTLDO} = 300mA$		400	600	mV
$\frac{\Delta V_{OUT}}{V_{OUTLDO}} * \Delta V_{INLDO}$	Line Regulation	$V_{INLDO} = V_{OUTLDO} + 1$ to $5.0V$		0.09		%/V
$\Delta V_{OUTLDO(LINE)}$	Dynamic Line Regulation	$I_{OUTLDO} = 300mA$ , $V_{INLDO} = V_{OUTLDO} + 1$ to $V_{OUTLDO} + 2$ , $T_R / T_F = 2\mu s$		2.5		mV
$\Delta V_{OUTLDO(LOAD)}$	Dynamic Load Regulation	$I_{OUTLDO} = 1mA$ to $300mA$ , $T_R < 5\mu s$		60		mV
$I_{OUTLDO}$	Output Current	$V_{OUTLDO} > 1.2V$		300		mA
$I_{SC}$	Short-Circuit Current	$V_{OUTLDO} < 0.4V$		600		mA
$I_{QLDO}$	Quiescent Current	$V_{INLDO} = 5V$ ; $V_{EN\_LDO} = V_{IN}$		70	125	$\mu A$
$I_{SHDN}$	Shutdown Current	$V_{INLDO} = 5V$ ; $V_{EN\_LDO} = 0V$			1.0	$\mu A$
PSRR	Power Supply Rejection Ratio	$I_{OUTLDO} = 10mA$	1kHz	65		dB
			10kHz	45		
			1MHz	43		
$T_{SD}$	Over-Temperature Shutdown Threshold			145		$^{\circ}C$
$T_{HYS}$	Over-Temperature Shutdown Hysteresis			12		$^{\circ}C$
$e_N$	Output Noise			50		$\mu V_{RMS}$
$T_C$	Output Voltage Temperature Coefficient			22		ppm/ $^{\circ}C$
$T_{EN\_LDO\_DLY}$	LDO Enable Time Delay	BYP Open		15		$\mu s$
$V_{EN\_LDO(L)}$	LDO Enable Threshold Low				0.6	V
$V_{EN\_LDO(H)}$	LDO Enable Threshold High		1.5			V
$I_{EN\_LDO}$	LDO Enable Input Current	$V_{EN\_LDO} = 5.5V$			1.0	$\mu A$

1. The AAT2557 is guaranteed to meet performance specifications over the  $-40^{\circ}C$  to  $+85^{\circ}C$  operating temperature range and is assured by design, characterization, and correlation with statistical process controls.

2.  $V_{DO}$  is defined as  $V_{IN} - V_{OUT}$  when  $V_{OUT}$  is 98% of nominal.

3. For  $V_{OUT} < 2.3V$ ,  $V_{DO} = 2.5V - V_{OUT}$ .

**500mA Battery Charger and 300mA LDO Regulator for Portable Systems**

**Electrical Characteristics<sup>1</sup>**

$V_{ADP} = 5V$ ;  $T_A = -40^{\circ}C$  to  $+85^{\circ}C$ , unless otherwise noted. Typical values are  $T_A = 25^{\circ}C$ .

Symbol	Description	Conditions	Min	Typ	Max	Units
<b>Battery Charger</b>						
<b>Operation</b>						
$V_{ADP}$	Adapter Voltage Range		4.0		6.5	V
$V_{UVLO}$	Under-Voltage Lockout (UVLO)	Rising Edge	3.0		4.0	V
	UVLO Hysteresis			150		mV
$I_{OP}$	Operating Current	Charge Current = 200mA		0.5	1	mA
$I_{SHUTDOWN}$	Shutdown Current	$V_{BAT} = 4.25V$ , $EN\_BAT = GND$		0.3	1	$\mu A$
$I_{LEAKAGE}$	Reverse Leakage Current from BAT Pin	$V_{BAT} = 4V$ , ADP Pin Open		0.4	2	$\mu A$
<b>Voltage Regulation</b>						
$V_{CO(REG)}$	Output Charge Voltage Regulation		4.158	4.20	4.242	V
$\Delta V_{CH}/V_{CH}$	Output Charge Voltage Tolerance			0.5		%
$V_{MIN}$	Preconditioning Voltage Threshold		2.85	3.0	3.15	V
$V_{RCH}$	Battery Recharge Voltage Threshold	Measured from $V_{CO(REG)}$		$V_{CO(REG)} - 0.1$		V
<b>Current Regulation</b>						
$I_{CH\_CC}$	Charge Current Programmable Range		15		500	mA
$\Delta I_{CH\_CC}/I_{CH\_CC}$	Charge Current Regulation Tolerance			10		%
$V_{ISET}$	ISET Pin Voltage			2		V
$K_{I\_A}$	Current Set Factor: $I_{CH}/I_{SET}$			800		
<b>Charging Devices</b>						
$R_{DS(ON)}$	Charging Transistor On Resistance	$V_{ADP} = 5.5V$		0.9	1.1	$\Omega$
<b>Logic Control/Protection</b>						
$V_{EN\_BAT(H)}$	Battery Charger Enable Threshold High		1.6			V
$V_{EN\_BAT(L)}$	Battery Charger Enable Threshold Low				0.4	V
$V_{STAT}$	STAT Pin Output Low Voltage	STAT Pin Sinks 4mA			0.4	V
$I_{STAT}$	STAT Pin Current Sink Capability				8	mA
$V_{OVP}$	Battery Over-Voltage Protection Threshold			4.4		V
$I_{CH\_TKL}/I_{CH\_CC}$	Preconditioning Charge Current	$I_{CH} = 100mA$		10		%
$I_{CH\_TERM}/I_{CH\_CC}$	Charge Termination Current			10		%

1. The AAT2557 is guaranteed to meet performance specifications over the  $-40^{\circ}C$  to  $+85^{\circ}C$  operating temperature range and is assured by design, characterization, and correlation with statistical process controls.

## 500mA Battery Charger and 300mA LDO Regulator for Portable Systems

### Typical Characteristics – Battery Charger

**Constant Charging Current vs. Set Resistor Values**

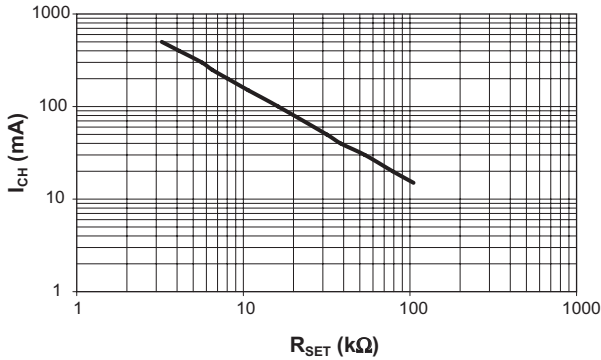

**Charging Current vs. Battery Voltage ( $V_{ADP} = 5V$ )**

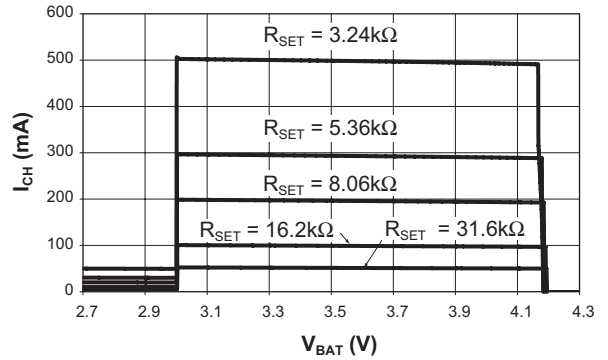

**Constant Output Charge Voltage Regulation vs. Adapter Voltage**

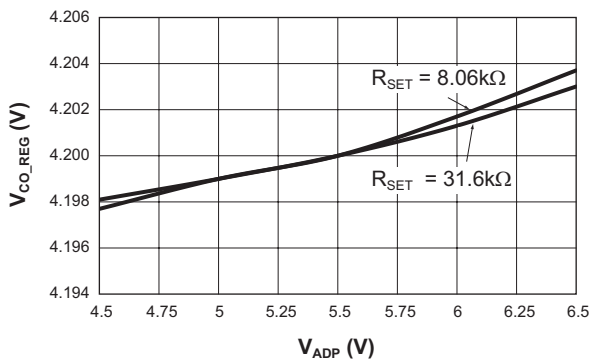

**Constant Output Charge Voltage Regulation vs. Temperature ( $R_{SET} = 8.06k\Omega$ )**

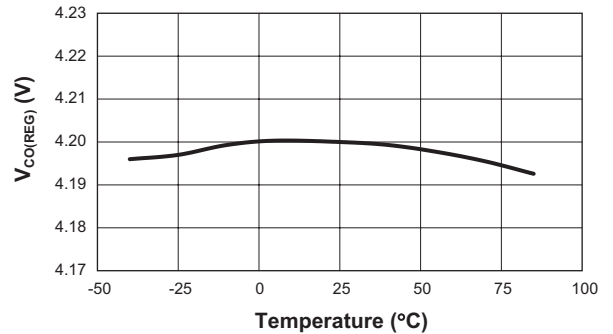

**Constant Charging Current vs. Adapter Voltage ( $R_{SET} = 8.06k\Omega$ )**

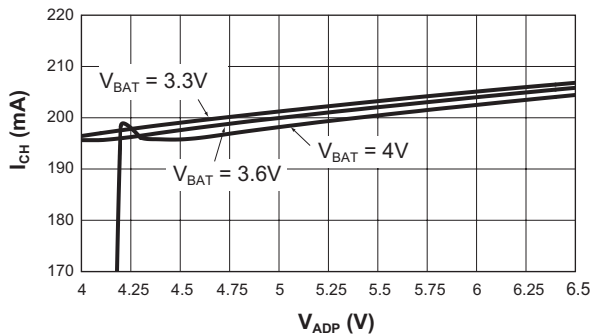

**Constant Charging Current vs. Temperature ( $R_{SET} = 8.06k\Omega$ )**

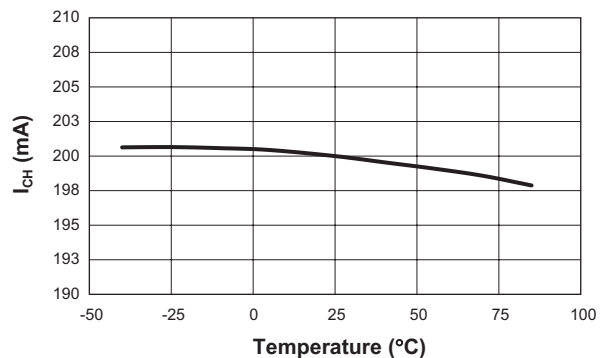

**500mA Battery Charger and 300mA LDO Regulator for Portable Systems**

**Typical Characteristics – Battery Charger**

**Recharging Voltage Threshold vs. Temperature**  
 ( $R_{SET} = 8.06k\Omega$ )

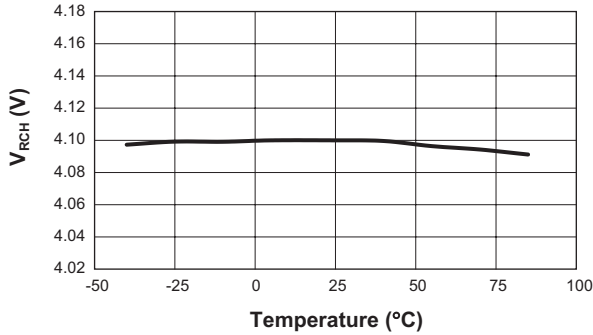

**Preconditioning Voltage Threshold vs. Temperature**  
 ( $R_{SET} = 8.06k\Omega$ )

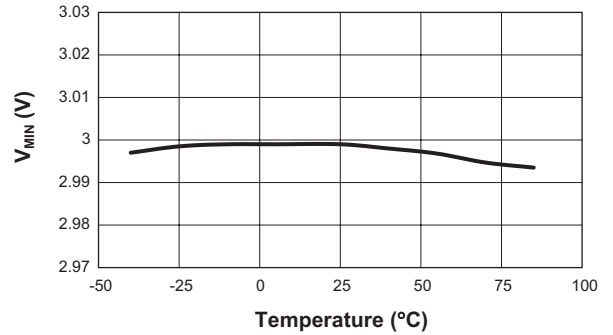

**Preconditioning Charge Current vs. Temperature**  
 ( $R_{SET} = 8.06k\Omega$ )

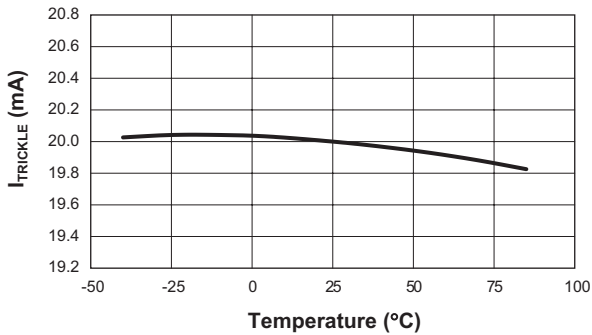

**Preconditioning Charge Current vs. Adapter Voltage**

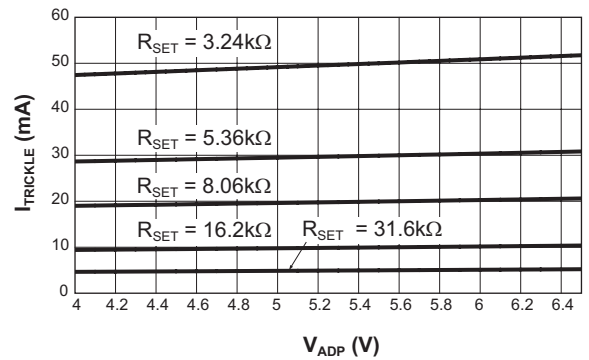

**Operating Current vs. Temperature**  
 ( $R_{SET} = 8.06k\Omega$ )

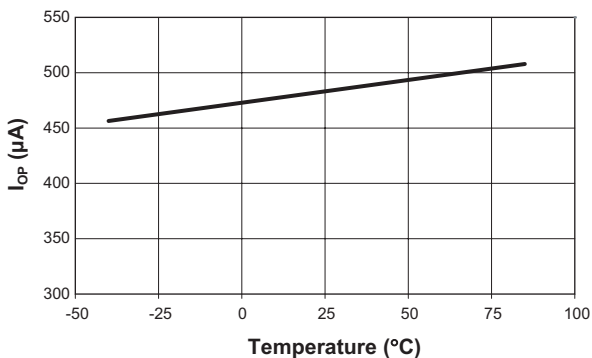

**Sleep Mode Current vs. Supply Voltage**  
 ( $R_{SET} = 8.06k\Omega$ )

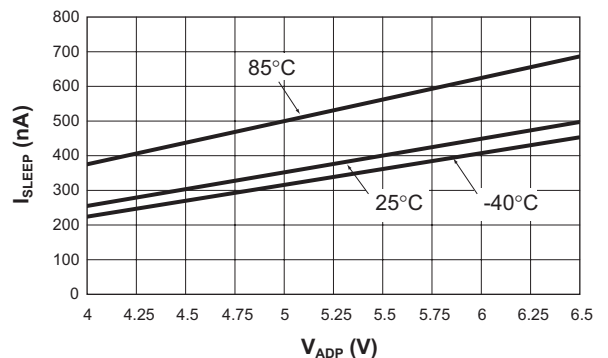

## 500mA Battery Charger and 300mA LDO Regulator for Portable Systems

### Typical Characteristics – Battery Charger

**Enable Input High Voltage vs. Adapter Voltage**  
( $R_{SET} = 8.06k\Omega$ )

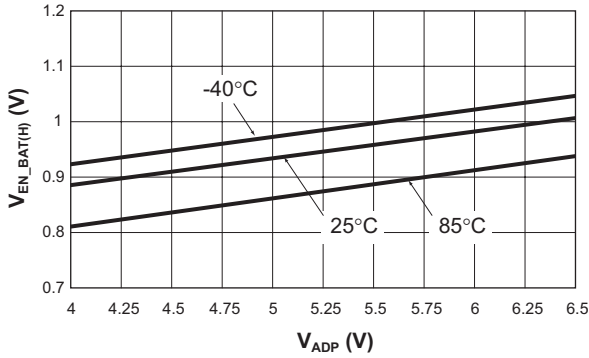

**Enable Input Low Voltage vs. Adapter Voltage**  
( $R_{SET} = 8.06k\Omega$ )

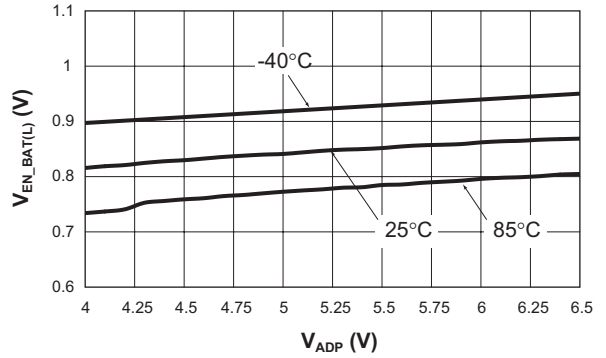

### Typical Characteristics – LDO Regulator

**Enable Input High and Low Voltages vs. Input Voltage**

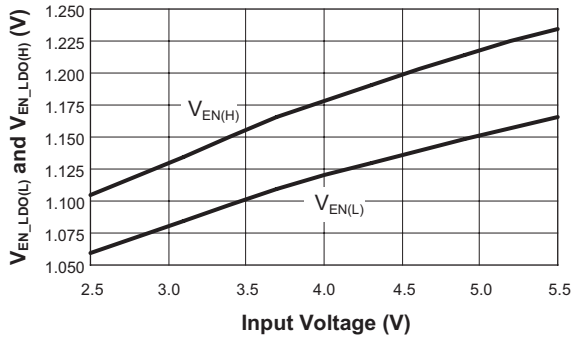

**Dropout Voltage vs. Temperature**

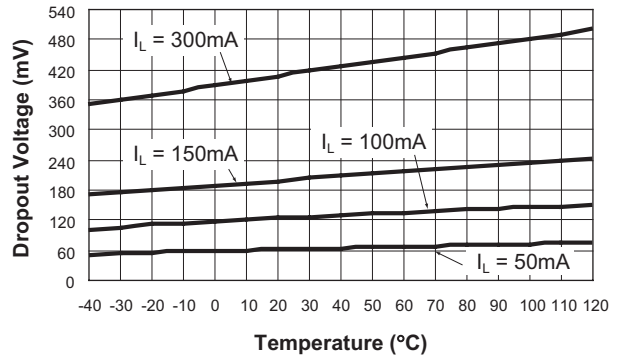

**Dropout Characteristics**

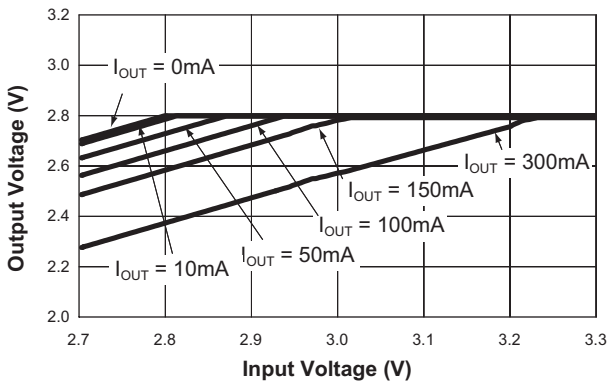

**Dropout Voltage vs. Output Current**

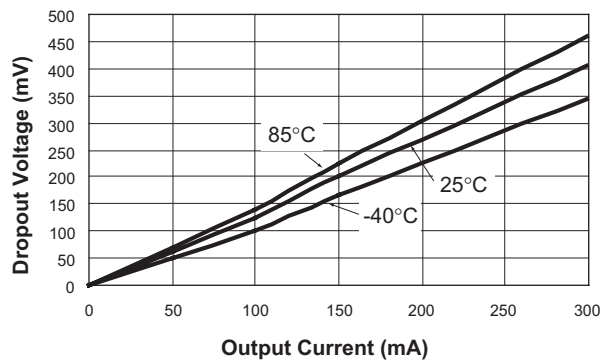



**500mA Battery Charger and 300mA LDO Regulator for Portable Systems**

**Typical Characteristics – LDO Regulator**

**Ground Current vs. Input Voltage**

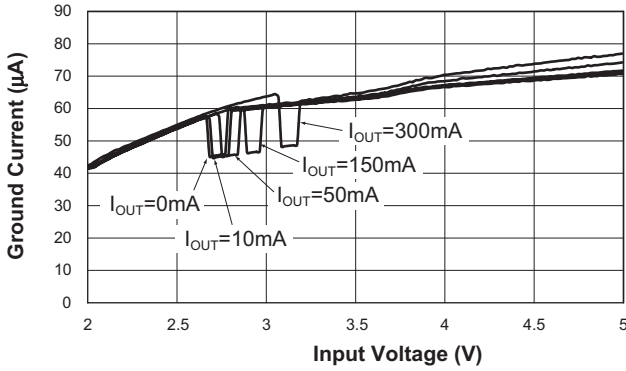

**Quiescent Current vs. Temperature**

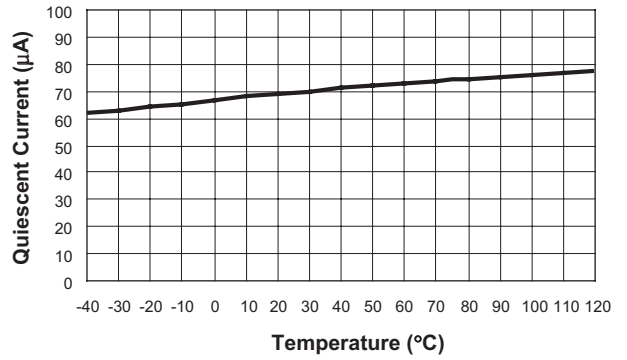

**Output Voltage vs. Temperature**

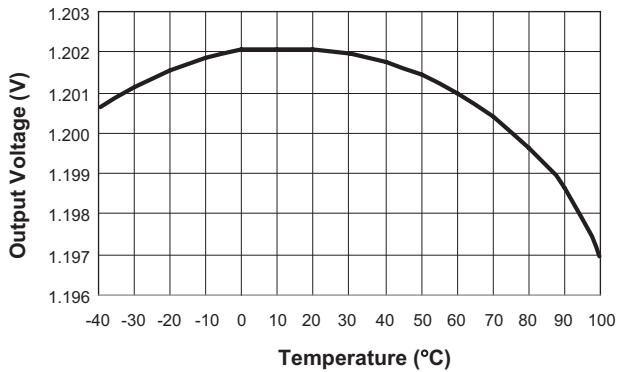

**LDO Initial Turn-On Response Time**

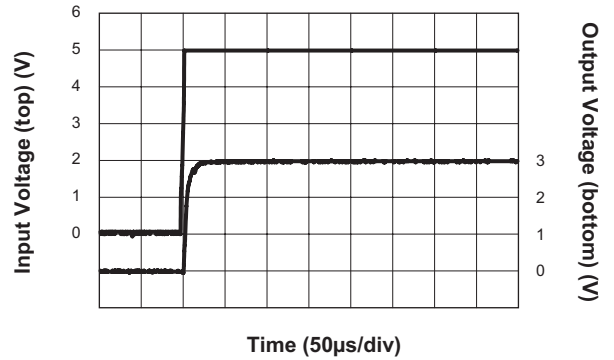

**LDO Turn-On Time from Enable ( $V_{IN}$  Present)**

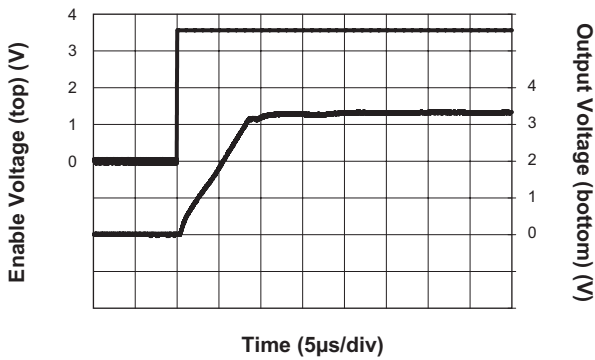

**LDO Turn-Off Response Time ( $I_{OUT} = 100mA$ )**

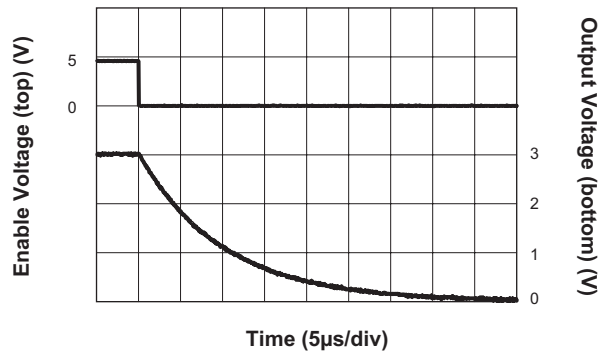

# AAT2557

## 500mA Battery Charger and 300mA LDO Regulator for Portable Systems

### Typical Characteristics – LDO Regulator

Line Transient Response

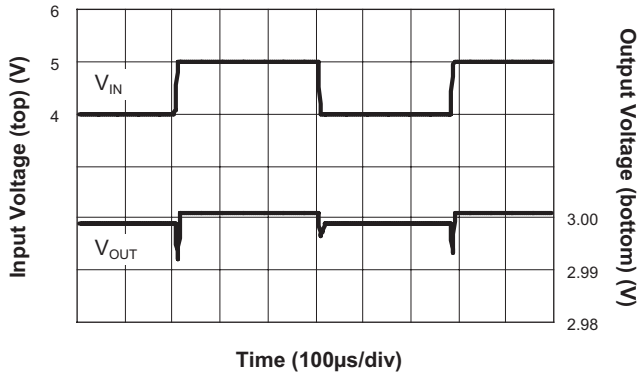

Load Transient Response

( $V_{OUT} = 2.8V$ )

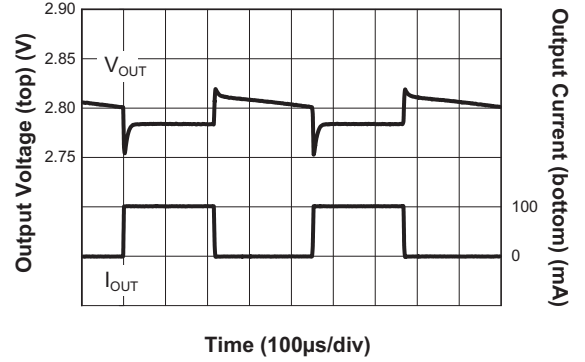

Load Transient Response 300mA

( $V_{OUT} = 2.8V$ )

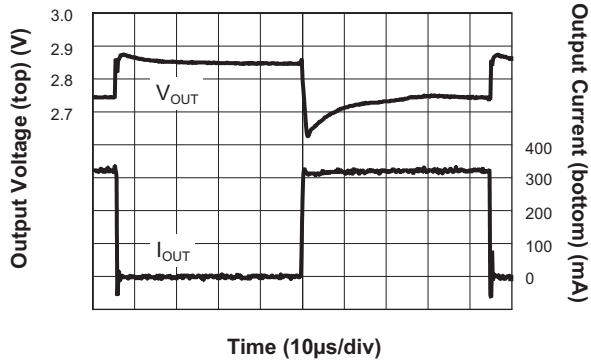

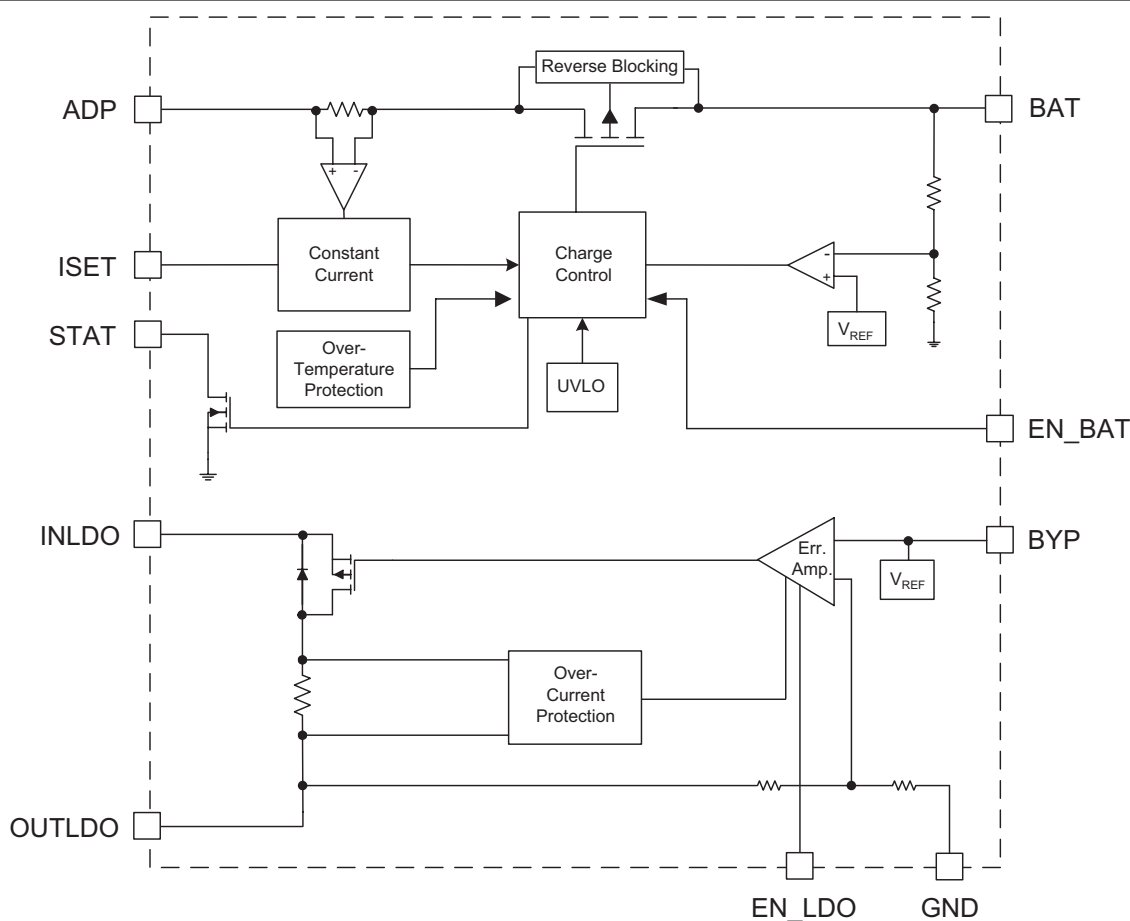
**500mA Battery Charger and 300mA LDO Regulator for Portable Systems****Functional Block Diagram****Functional Description**

The AAT2557 is a high performance power management IC comprised of a lithium-ion/polymer battery charger and a linear regulator.

**Battery Charger**

The battery charger is designed for single-cell lithium-ion/polymer batteries using a constant current and constant voltage algorithm. The battery charger operates from the adapter/USB input voltage range from 4V to 6.5V. The adapter/USB charging current level can be programmed up to 500mA for rapid charging applications. A status monitor output pin is provided to indicate

the battery charge state by directly driving one external LED. Internal device temperature and charging state are fully monitored for fault conditions. Fault condition can be one of the following:

- Battery over-voltage (OV)
- Battery temperature sense hot or cold
- Battery charge timer time-out
- Chip thermal shutdown

In the event of an over-voltage or over-temperature failure, the device will automatically shut down, protecting the charging device, control system, and the battery under charge. Other features include an integrated reverse blocking diode and sense resistor.

**500mA Battery Charger and 300mA LDO Regulator for Portable Systems****Linear Regulator**

The advanced circuit design of the linear regulator has been specifically optimized for very fast start-up. This proprietary CMOS LDO has also been tailored for superior transient response characteristics. These traits are particularly important for applications that require fast power supply timing.

The high-speed turn-on capability is enabled through implementation of a fast-start control circuit which accelerates the power-up behavior of fundamental control and feedback circuits within the LDO regulator. The LDO regulator output has been specifically optimized to function with low-cost, low-ESR ceramic capacitors; however, the design will allow for operation over a wide range of capacitor types.

The regulator comes with complete short-circuit and thermal protection. The combination of these two internal protection circuits gives a comprehensive safety system to guard against extreme adverse operating conditions.

The regulator features an enable/disable function. The EN\_LDO pin is active high and is compatible with CMOS logic levels. To assure the LDO regulator will turn on, the EN\_LDO control level must be greater than 1.5V. The LDO regulator will be disabled when the voltage on the EN\_LDO pin falls below 0.6V. If the enable function is not needed in a specific application, it may be tied to INLDO to keep the LDO regulator in a continuously on state.

**Battery Charger Under-Voltage Lockout**

The AAT2557 has internal circuits for UVLO and power on reset features. If the ADP supply voltage drops below the UVLO threshold, the battery charger will suspend charging and shut down. When power is reapplied to the ADP pin or the UVLO condition recovers, the system charge control will automatically resume charging in the appropriate mode for the condition of the battery.

**Protection Circuitry****Over-Voltage Protection**

When the voltage on the BAT pin exceeds the over-voltage protection threshold ( $V_{OVP} = 4.4V$ ) it is defined as an over-voltage protection event. If this over-voltage condition occurs, the charger control circuitry will shut down the device. The charger will resume normal charging operation after the over-voltage condition is removed.

**Over-Temperature Protection**

The AAT2557's battery charger has a thermal protection circuit which will shut down charging functions when the internal die temperature exceeds the preset thermal limit threshold (145°C). Once the internal die temperature falls below the thermal limit, normal charging operation will resume. The AAT2557's LDO also has an internal thermal protection circuit which will turn on when the device die temperature exceeds 145°C. The internal thermal protection circuit will actively turn off the LDO regulator output pass device to prevent the possibility of over temperature damage. The LDO regulator output will remain in a shutdown state until the internal die temperature falls back to 12°C below the 145°C trip point.

**Short-Circuit Protection**

The AAT2557's LDO contains an internal short-circuit protection circuit that will trigger when the output load current exceeds the internal threshold limit. Under short-circuit conditions, the output of the LDO regulator will be current limited until the short-circuit condition is removed from the output or until the package power dissipation exceeds the device thermal limit.

The combination and interaction between the short-circuit and thermal protection systems allow the LDO regulator to withstand indefinite short-circuit conditions without sustaining permanent damage.

**500mA Battery Charger and 300mA LDO Regulator for Portable Systems**

**Battery Charging Operation**

Battery charging commences only after checking several conditions in order to maintain a safe charging environment. The input supply (ADP) must be above the minimum operating voltage (UVLO) and the enable pin must be high (internally pulled down). When the battery is connected to the BAT pin, the charger checks the condition of the battery and determines which charging mode to apply. If the battery voltage is below  $V_{MIN}$ , the charger begins battery pre-conditioning by charging at 10% of the programmed constant current; e.g., if the programmed current is 150mA, then the pre-conditioning current (trickle charge) is 15mA. Pre-conditioning is purely a safety precaution for a deeply discharged cell and will also reduce the power dissipation in the internal series MOSFET pass device when the input-output voltage differential is at its highest.

Pre-conditioning continues until the battery voltage reaches  $V_{MIN}$  (see Figure 1). At this point, the charger begins constant-current charging. The current level for this mode is programmed using a single resistor from

the ISET pin to ground. Programmed current can be set from a minimum 15mA up to a maximum of 500mA. Constant current charging will continue until the battery voltage reaches the voltage regulation point,  $V_{BAT}$  and the battery charger begins constant voltage mode. The regulation voltage is factory programmed to a nominal 4.2V and will continue charging until the charging current has reduced to 10% of the programmed current.

After the charge cycle is complete, the pass device turns off and the device automatically goes into a power-saving sleep mode. During this time, the series pass device will block current in both directions, preventing the battery from discharging through the IC.

The battery charger will remain in sleep mode, even if the charger source is disconnected, until one of the following events occurs: the battery terminal voltage drops below the  $V_{RCH}$  threshold; the charger EN pin is recycled; or the charging source is reconnected. In all cases, the charger will monitor all parameters and resume charging in the most appropriate mode.

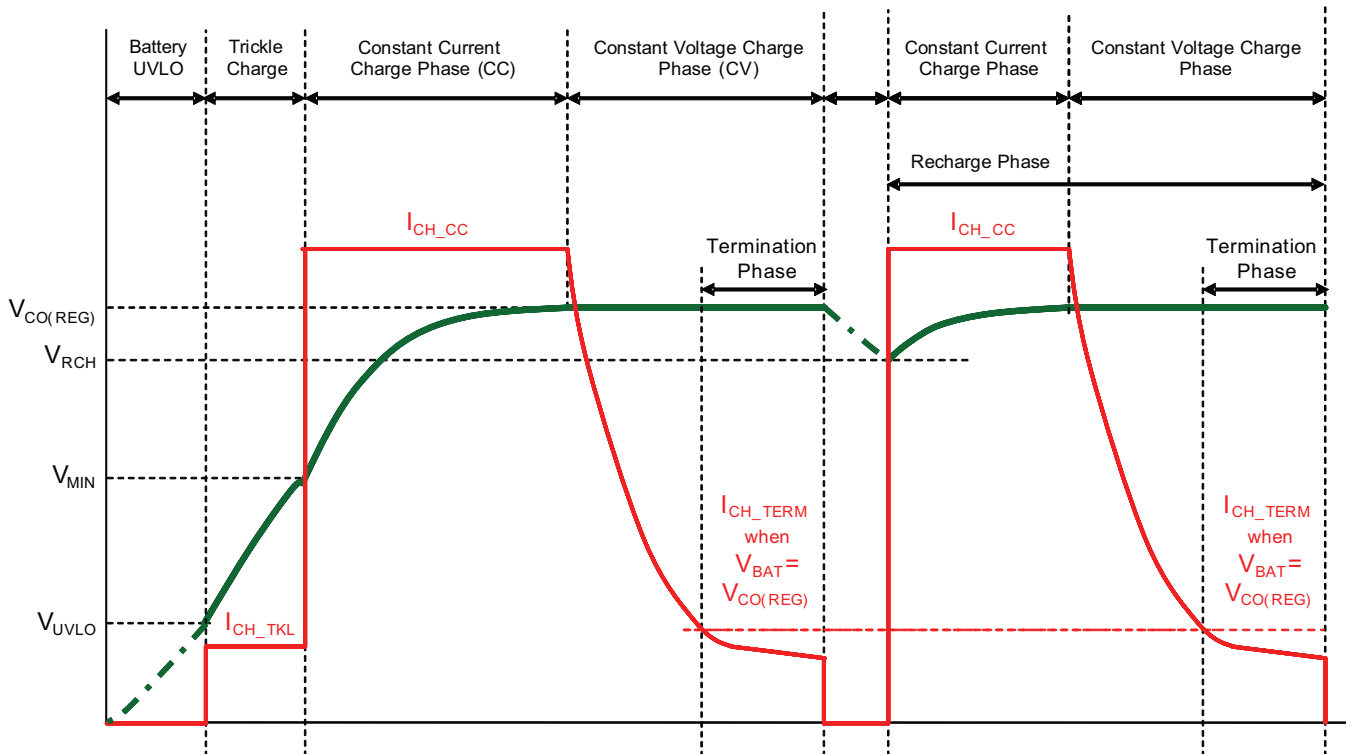

**Figure 1: Current vs. Voltage Profile During Charging Phases.**

**500mA Battery Charger and 300mA LDO Regulator for Portable Systems**

**Battery Charging System Operation Flow Chart**

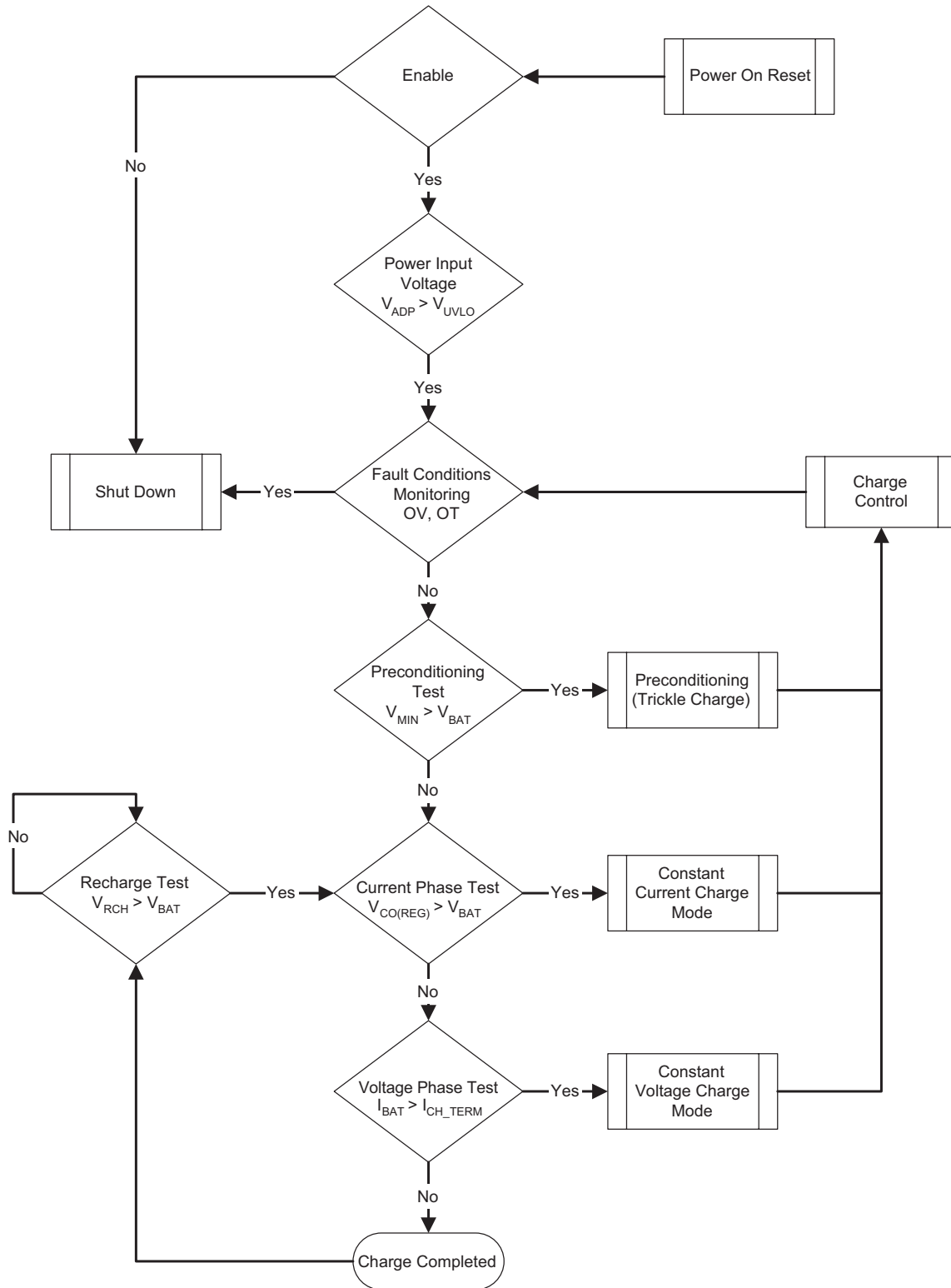

## 500mA Battery Charger and 300mA LDO Regulator for Portable Systems

### Application Information

#### Soft Start / Enable

The EN\_BAT pin is internally pulled down. When pulled to a logic high level, the battery charger is enabled. When left open or pulled to a logic low level, the battery charger is shut down and forced into the sleep state. Charging will be halted regardless of the battery voltage or charging state. When it is re-enabled, the charge control circuit will automatically reset and resume charging functions with the appropriate charging mode based on the battery charge state and measured cell voltage from the BAT pin.

The LDO is enabled when the EN\_LDO pin is pulled high. The control and feedback circuits have been optimized for high-speed, monotonic turn-on characteristics.

#### Adapter or USB Power Input

Constant current charge levels up to 500mA may be programmed by the user when powered from a sufficient input power source. The battery charger will operate from the adapter input over a 4.0V to 6.5V range.

#### Programming Charge Current

The fast charge constant current charge level is user programmable with a set resistor placed between the ISET pin and ground. The accuracy of the fast charge, as well as the preconditioning trickle charge current, is dominated by the tolerance of the set resistor used. For this reason, a 1% tolerance metal film resistor is recommended for the set resistor function. Fast charge constant current levels from 15mA to 500mA may be set by selecting the appropriate resistor value from Table 2.

#### Charge Status Output

The AAT2557 provides battery charge status via a status pin. This pin is internally connected to an N-channel open drain MOSFET, which can be used to drive an external LED. The status pin can indicate several conditions, as shown in Table 1.

Event Description	Status
No battery charging activity	OFF
Battery charging via adapter or USB port	ON
Charging completed	OFF

**Table 1: LED Status Indicator.**

Constant Charge Current $I_{CH\_CC}$ (mA)	Set Resistor Value (k $\Omega$ )
500	3.24
400	4.12
300	5.36
250	6.49
200	8.06
150	10.7
100	16.2
50	31.6
40	38.3
30	53.6
20	78.7
15	105

**Table 2: R<sub>SET</sub> Values.**

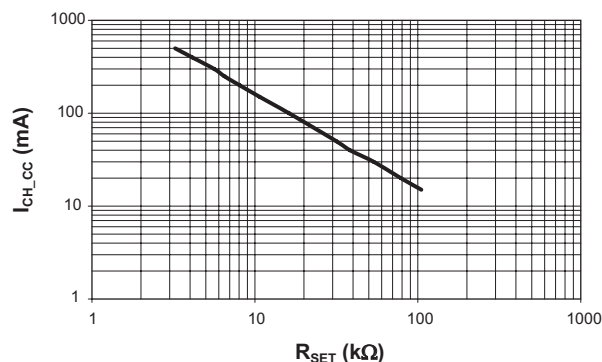

**Figure 2: Constant Charging Current vs. Set Resistor Values.**

The LED should be biased with as little current as necessary to create reasonable illumination; therefore, a ballast resistor should be placed between the LED cathode and the STAT pin. LED current consumption will add to the overall thermal power budget for the device package, hence it is good to keep the LED drive current to a minimum. 2mA should be sufficient to drive most low-cost green or red LEDs. It is not recommended to exceed 8mA for driving an individual status LED.

**500mA Battery Charger and 300mA LDO Regulator for Portable Systems**

The required ballast resistor values can be estimated using the following formulas:

$$R_1 = \frac{(V_{ADP} - V_{F(LED)})}{I_{LED}}$$

Example:

$$R_1 = \frac{(5.5V - 2.0V)}{2mA} = 1.75k\Omega$$

Note: Red LED forward voltage ( $V_F$ ) is typically 2.0V @ 2mA.

**Thermal Considerations**

The AAT2557 is offered in a TSOPJW-14 package which can provide up to 625mW of power dissipation when it is properly bonded to a printed circuit board and has a maximum thermal resistance of 160°C/W. Many considerations should be taken into account when designing the printed circuit board layout, as well as the placement of the charger IC package in proximity to other heat generating devices in a given application design. The ambient temperature around the IC will also have an effect on the thermal limits of a battery charging application. The maximum limits that can be expected for a given ambient condition can be estimated by the following discussion.

First, the maximum power dissipation for a given situation should be calculated:

$$P_{D(MAX)} = \frac{(T_{J(MAX)} - T_A)}{\theta_{JA}}$$

Where:

- $P_{D(MAX)}$  = Maximum Power Dissipation (W)
- $\theta_{JA}$  = Package Thermal Resistance (°C/W)
- $T_{J(MAX)}$  = Maximum Device Junction Temperature (°C) [135°C]
- $T_A$  = Ambient Temperature (°C)

$$P_D = [(V_{ADP} - V_{BAT}) \cdot I_{CH} + (V_{ADP} \cdot I_{OP})] + (V_{INLDO} - V_{OUTLDO}) I_{OUTLDO} + V_{INLDO} \cdot I_{QLDO}$$

Where:

- $P_D$  = Total Power Dissipation by the Device
- $V_{ADP}$  = ADP/USB Voltage
- $V_{BAT}$  = Battery Voltage as Seen at the BAT Pin
- $I_{CH}$  = Constant Charge Current Programmed for the Application
- $I_{OP}$  = Quiescent Current Consumed by the Charger IC for Normal Operation [0.5mA]
- $V_{INLDO}$  = Input Voltage as Seen at the INLDO Pin
- $V_{OUTLDO}$  = Output Voltage as Seen at the OUTLDO Pin
- $I_{OUTLDO}$  = LDO Load Current
- $I_{QLDO}$  = LDO Quiescent Current

By substitution, we can derive the maximum charge current before reaching the thermal limit condition (thermal cycling). The maximum charge current is the key factor when designing battery charger applications.

$$I_{CH(MAX)} = \frac{(P_{D(MAX)} - V_{IN} \cdot I_{OP})}{V_{IN} - V_{BAT}}$$

$$I_{CH(MAX)} = \frac{(\frac{(T_{J(MAX)} - T_A)}{\theta_{JA}} - V_{IN} \cdot I_{OP})}{V_{IN} - V_{BAT}}$$

In general, the worst condition is the greatest voltage drop across the IC, when battery voltage is charged up to the preconditioning voltage threshold.

**Capacitor Selection****Linear Regulator Input Capacitor**

An input capacitor greater than 1μF will offer superior input line transient response and maximize power supply ripple rejection. Ceramic, tantalum, or aluminum electrolytic capacitors may be selected since there is no specific capacitor ESR requirement for  $C_{INLDO}$ . However, for best performance of the LDO regulator at maximum load current output, ceramic capacitors are recommended for  $C_{INLDO}$  due to their inherent capability over tantalum capacitors to withstand input current surges from low impedance sources such as batteries in portable devices.



**500mA Battery Charger and 300mA LDO Regulator for Portable Systems****Battery Charger Input Capacitor**

In general, it is good design practice to place a decoupling capacitor between the ADP pin and GND. An input capacitor in the range of 1 $\mu$ F to 22 $\mu$ F is recommended. If the source supply is unregulated, it may be necessary to increase the capacitance to keep the input voltage above the under-voltage lockout threshold during device enable and when battery charging is initiated. If the adapter input is to be used in a system with an external power supply source, such as a typical AC-to-DC wall adapter, then a C<sub>ADP</sub> capacitor in the range of 10 $\mu$ F should be used. A larger input capacitor in this application will minimize switching or power transient effects when the power supply is "hot plugged" in.

**Linear Regulator Output Capacitor**

For proper load voltage regulation and operational stability, a capacitor is required between OUT and GND. The C<sub>OUTLDO</sub> capacitor connection to the LDO regulator ground pin should be made as directly as practically possible for maximum device performance. Since the regulator has been designed to function with very low ESR capacitors, ceramic capacitors in the 1.0 $\mu$ F to 10 $\mu$ F range are recommended for best performance. Applications utilizing the exceptionally low output noise and optimum power supply ripple rejection should use 2.2 $\mu$ F or greater for C<sub>OUTLDO</sub>. In low output current applications, where output load is less than 10mA, the minimum value for C<sub>OUTLDO</sub> can be as low as 0.47 $\mu$ F.

**Battery Charger Output Capacitor**

The AAT2557 only requires a 1 $\mu$ F ceramic capacitor on the BAT pin to maintain circuit stability. This value should be increased to 10 $\mu$ F or more if the battery connection is made any distance from the charger output. If the AAT2557 is to be used in applications where the battery can be removed from the charger, such as with desktop charging cradles, an output capacitor greater than 10 $\mu$ F

may be required to prevent the device from cycling on and off when no battery is present.

**Bypass Capacitor and Low Noise Applications**

A bypass capacitor pin is provided to enhance the low noise characteristics of the AAT2557 LDO regulator. The bypass capacitor is not necessary for operation of the AAT2557. However, for best device performance, a small ceramic capacitor should be placed between the bypass pin (BYP) and the device ground pin (GND). The value of C<sub>BYP</sub> may range from 470pF to 10nF. For lowest noise and best possible power supply ripple rejection performance, a 10nF capacitor should be used. To practically realize the highest power supply ripple rejection and lowest output noise performance, it is critical that the capacitor connection between the BYP pin and GND pin be direct and PCB traces should be as short as possible. Refer to the PCB Layout Recommendations section of this document for examples.

There is a relationship between the bypass capacitor value and the LDO regulator turn-on and turnoff time. In applications where fast device turn-on and turn-off time are desired, the value of C<sub>BYP</sub> should be reduced.

In applications where low noise performance and/or ripple rejection are less of a concern, the bypass capacitor may be omitted. The fastest device turn-on time will be realized when no bypass capacitor is used.

**Printed Circuit Board Layout Considerations**

For the best results, it is recommended to physically place the battery pack as close as possible to the AAT2557 BAT pin. To minimize voltage drops on the PCB, keep the high current carrying traces adequately wide. The input capacitors should connect as closely as possible to ADP and INLDO.

Manufacturer	Part Number	Value ( $\mu$ F)	Voltage Rating	Temp. Co.	Case Size
Murata	GRM21BR61A106KE19	10	10	X5R	0805
Murata	GRM188R60J475KE19	4.7	6.3	X5R	0603
Murata	GRM188R61A225KE34	2.2	10	X5R	0603
Murata	GRM188R60J225KE19	2.2	6.3	X5R	0603
Murata	GRM188R61A105KA61	1.0	10	X5R	0603
Murata	GRM185R60J105KE26	1.0	6.3	X5R	0603
Murata	GRM188F51H103ZA01	0.01	50	Y5V	0603
Murata	GRM155F51H103ZA01	0.01	50	Y5V	0402

**Table 3: Surface Mount Capacitors.**

**500mA Battery Charger and 300mA LDO Regulator for Portable Systems**

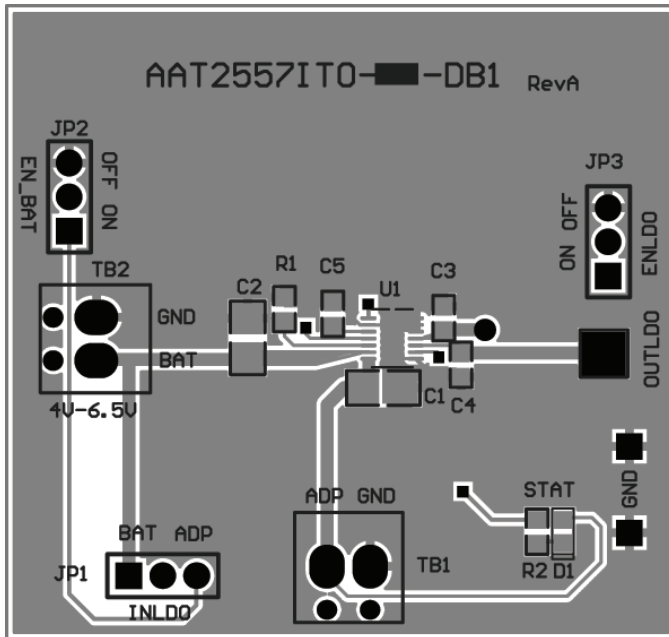

**Figure 3: AAT2557 Evaluation Board Top Side Layout.**

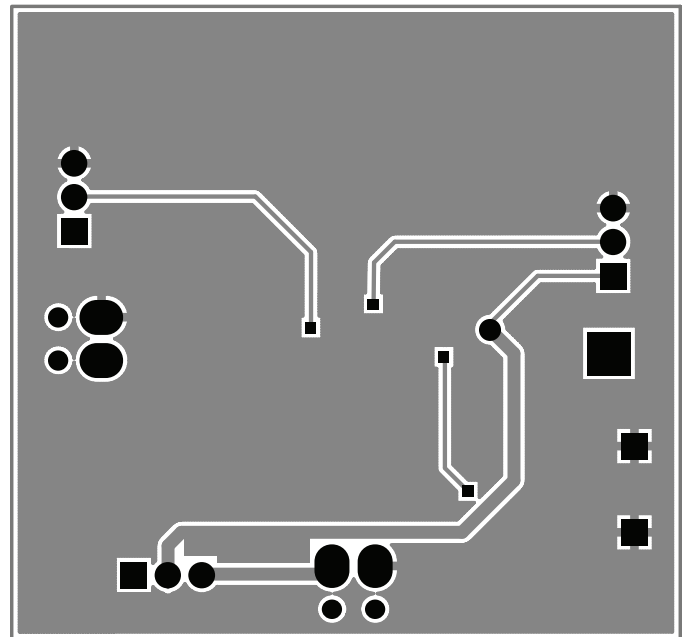

**Figure 4: AAT2557 Evaluation Board Bottom Side Layout.**

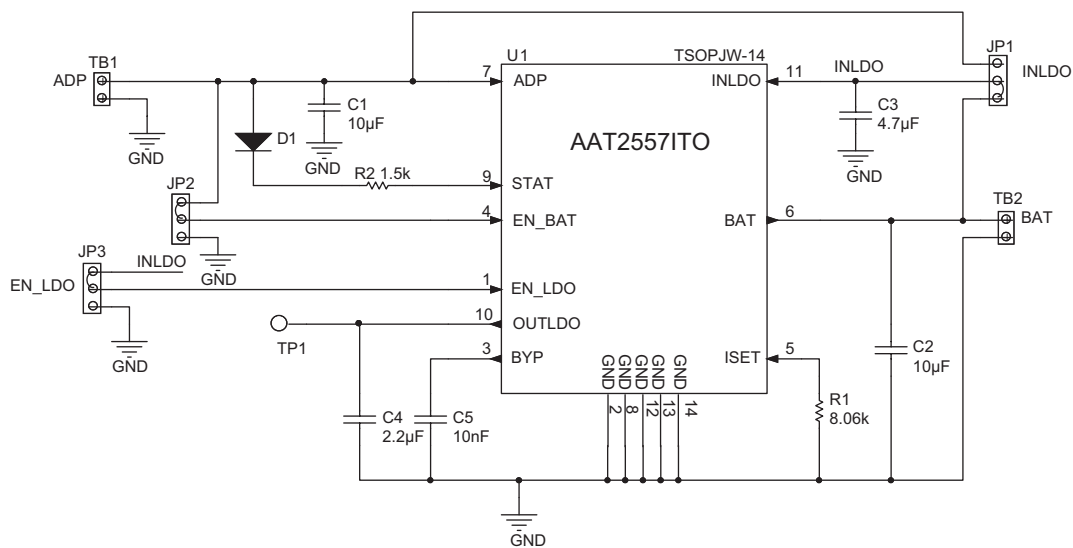

**Figure 5: AAT2557 Evaluation Board Schematic.**

# AAT2557

## 500mA Battery Charger and 300mA LDO Regulator for Portable Systems

### Ordering Information

Package	Marking <sup>1</sup>	Part Number (Tape and Reel) <sup>2</sup>
TSOPJW-14	VKXYY	<b>AAT2557ITO-CT-T1</b>
TSOPJW-14	9ZXYY	<b>AAT2557ITO-CW-T1</b>



Skyworks Green™ products are compliant with all applicable legislation and are halogen-free.

For additional information, refer to *Skyworks*

*Definition of Green™*, document number

SQ04-0074.

Legend	
Voltage	Code
1.2	E
1.5	G
1.8	I
1.9	Y
2.5	N
2.6	O
2.7	P
2.8	Q
2.85	R
2.9	S
3.0	T
3.3	W
4.2	C

1. XYY = assembly and date code.

2. Sample stock is generally held on part numbers listed in **BOLD**.

**500mA Battery Charger and 300mA LDO Regulator for Portable Systems**

**Package Information**

**TSOPJW-14**

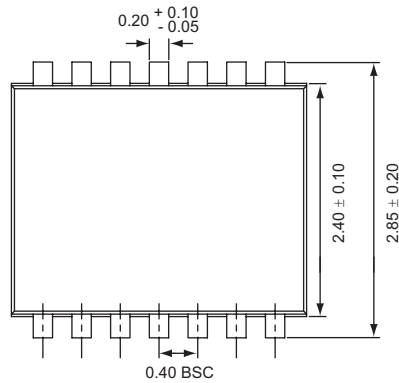

Top View

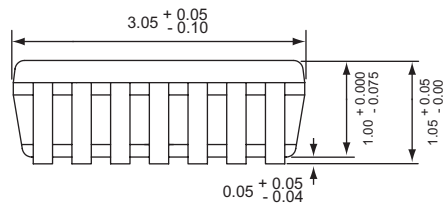

Side View

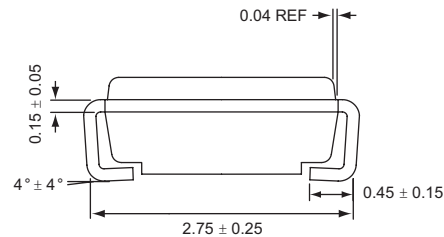

End View

All dimensions in millimeters.

Copyright © 2012 Skyworks Solutions, Inc. All Rights Reserved.

Information in this document is provided in connection with Skyworks Solutions, Inc. ("Skyworks") products or services. These materials, including the information contained herein, are provided by Skyworks as a service to its customers and may be used for informational purposes only by the customer. Skyworks assumes no responsibility for errors or omissions in these materials or the information contained herein. Skyworks may change its documentation, products, services, specifications or product descriptions at any time, without notice. Skyworks makes no commitment to update the materials or information and shall have no responsibility whatsoever for conflicts, incompatibilities, or other difficulties arising from any future changes.

No license, whether express, implied, by estoppel or otherwise, is granted to any intellectual property rights by this document. Skyworks assumes no liability for any materials, products or information provided hereunder, including the sale, distribution, reproduction or use of Skyworks products, information or materials, except as may be provided in Skyworks Terms and Conditions of Sale.

THE MATERIALS, PRODUCTS AND INFORMATION ARE PROVIDED "AS IS" WITHOUT WARRANTY OF ANY KIND, WHETHER EXPRESS, IMPLIED, STATUTORY, OR OTHERWISE, INCLUDING FITNESS FOR A PARTICULAR PURPOSE OR USE, MERCHANTABILITY, PERFORMANCE, QUALITY OR NON-INFRINGEMENT OF ANY INTELLECTUAL PROPERTY RIGHT; ALL SUCH WARRANTIES ARE HEREBY EXPRESSLY DISCLAIMED. SKYWORKS DOES NOT WARRANT THE ACCURACY OR COMPLETENESS OF THE INFORMATION, TEXT, GRAPHICS OR OTHER ITEMS CONTAINED WITHIN THESE MATERIALS. SKYWORKS SHALL NOT BE LIABLE FOR ANY DAMAGES, INCLUDING BUT NOT LIMITED TO ANY SPECIAL, INDIRECT, INCIDENTAL, STATUTORY, OR CONSEQUENTIAL DAMAGES, INCLUDING WITHOUT LIMITATION, LOST REVENUES OR LOST PROFITS THAT MAY RESULT FROM THE USE OF THE MATERIALS OR INFORMATION, WHETHER OR NOT THE RECIPIENT OF MATERIALS HAS BEEN ADVISED OF THE POSSIBILITY OF SUCH DAMAGE.

Skyworks products are not intended for use in medical, lifesaving or life-sustaining applications, or other equipment in which the failure of the Skyworks products could lead to personal injury, death, physical or environmental damage. Skyworks customers using or selling Skyworks products for use in such applications do so at their own risk and agree to fully indemnify Skyworks for any damages resulting from such improper use or sale.

Customers are responsible for their products and applications using Skyworks products, which may deviate from published specifications as a result of design defects, errors, or operation of products outside of published parameters or design specifications. Customers should include design and operating safeguards to minimize these and other risks. Skyworks assumes no liability for applications assistance, customer product design, or damage to any equipment resulting from the use of Skyworks products outside of stated published specifications or parameters.

Skyworks, the Skyworks symbol, and "Breakthrough Simplicity" are trademarks or registered trademarks of Skyworks Solutions, Inc., in the United States and other countries. Third-party brands and names are for identification purposes only, and are the property of their respective owners. Additional information, including relevant terms and conditions, posted at [www.skyworksinc.com](http://www.skyworksinc.com), are incorporated by reference.