

- 注記**
NOTES
- 材料及び仕上げ：表参照
MATERIAL AND FINISH: SEE CHART
 - エンボス梱包品の詳細は、554560259 PSD 000を参照のこと。
DETAILED TAPING PACKAGE, SEE 554560259 PSD 000
 - 製品番号
MATERIAL NO.
55456-****
- 極数 CIRCUIT SIZE (2~20)
ボス BOSS 5: 有り WITH BOSS
6: 無し WITHOUT BOSS
色 COLOR 0: 自然色 NATURAL
- 本製品は55456-**10/**30/**70/**80の鉛フリー品である。
THIS PRODUCT IS LEAD FREE OF 55456-**10/**30/**70/**80.
 - ELV及びRoHS適合品
ELV AND RoHS COMPLIANT

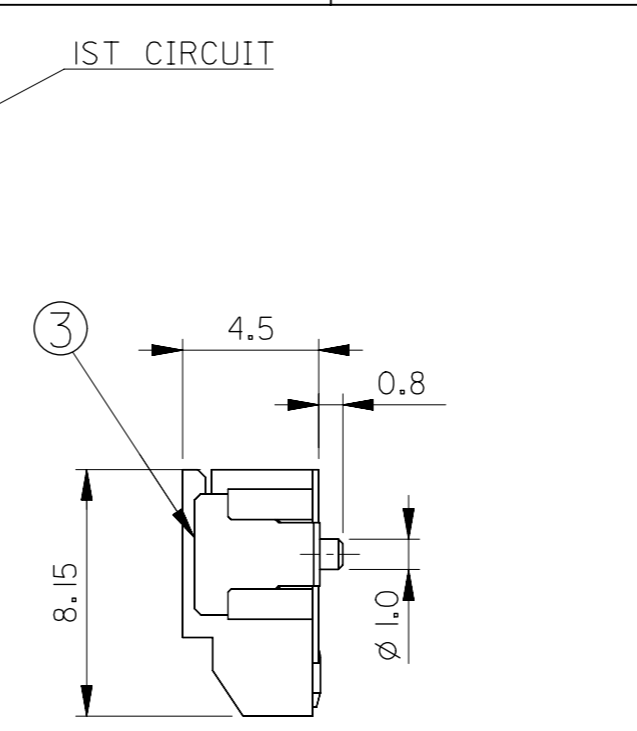

番号 NO.	名称 NAME	材料 MATERIAL	数量 QT'Y	仕上げ FINISH
①	ウエハー WAFER	ナイロン NYLON	1	UL94-0 色：原色 COLOR: NATURAL
②	ピン PIN	黄銅 BRASS	N	全体錫めっき PRE-TINNED
③	ネール NAIL	黄銅 BRASS	2	錫めっき TIN PLATING

ボス無しタイプ WITHOUT BOSS	ボス有りタイプ WITH BOSS
55456-**6*	55456-**5*

27.25	25.95	23.75	28.65	55456-2060	ボス無しタイプ WITHOUT BOSS 55456-**6*	55456-2050	ボス有りタイプ WITH BOSS 55456-**5*
26	24.7	22.5	27.4	55456-1960		55456-1950	
24.75	23.45	21.25	26.15	55456-1860		55456-1850	
23.5	22.2	20	24.9	55456-1760		55456-1750	
22.25	20.95	18.75	23.65	55456-1660		55456-1650	
21	19.7	17.5	22.4	55456-1560		55456-1550	
19.75	18.45	16.25	21.15	55456-1460		55456-1450	
18.5	17.2	15	19.9	55456-1360		55456-1350	
17.25	15.95	13.75	18.65	55456-1260		55456-1250	
16	14.7	12.5	17.4	55456-1160		55456-1150	
14.75	13.45	11.25	16.15	55456-1060		55456-1050	
13.5	12.2	10	14.9	55456-0960		55456-0950	
12.25	10.95	8.75	13.65	55456-0860		55456-0850	
11	9.7	7.5	12.4	55456-0760		55456-0750	
9.75	8.45	6.25	11.15	55456-0660		—/—	
8.5	7.2	5	9.9	55456-0560		55456-0550	
7.25	5.95	3.75	8.65	55456-0460		55456-0450	
6	4.7	2.5	7.4	55456-0360		—/—	
4.75	3.45	1.25	6.15	55456-0260		55456-0250	
D	C	B	A	△ MATERIAL NO.		MODEL NO.	

THIS DRAWING CONTAINS INFORMATION THAT IS PROPRIETARY TO MOLEX ELECTRONIC TECHNOLOGIES, LLC AND SHOULD NOT BE USED WITHOUT WRITTEN PERMISSION

REDRAWN AND REVISED EC NO: 112233 DRWN: QHE31 CHK'D: SAKIYAMA APPR: TKANEKO	2017/01/10	2017/01/16	2017/01/16	GENERAL TOLERANCES (UNLESS SPECIFIED) ANGULAR TOL ± 3.0 ° 4 PLACES ± 0.2 3 PLACES ± 0.2 2 PLACES ± 0.2 1 PLACE ± 0.2 0 PLACES ± 0.2 DRAFT WHERE APPLICABLE MUST REMAIN WITHIN DIMENSIONS	DIMENSION UNITS	SCALE			
	DRWN BY	DATE	MM		4:1				
	CHK'D BY	DATE	QHE31		2017/01/10				
	APPR BY	DATE	SAKIYAMA		2017/01/16				
				DRAWING SIZE	THIRD ANGLE PROJECTION	PRODUCT CUSTOMER DRAWING			
				A3		SERIES	MATERIAL NUMBER	CUSTOMER	
						55456	SEE TABLE OF SHEET 1		
						DOCUMENT NUMBER	DOC TYPE	DOC PART	SHEET NUMBER
						554560250	PSD	000	1 OF 2

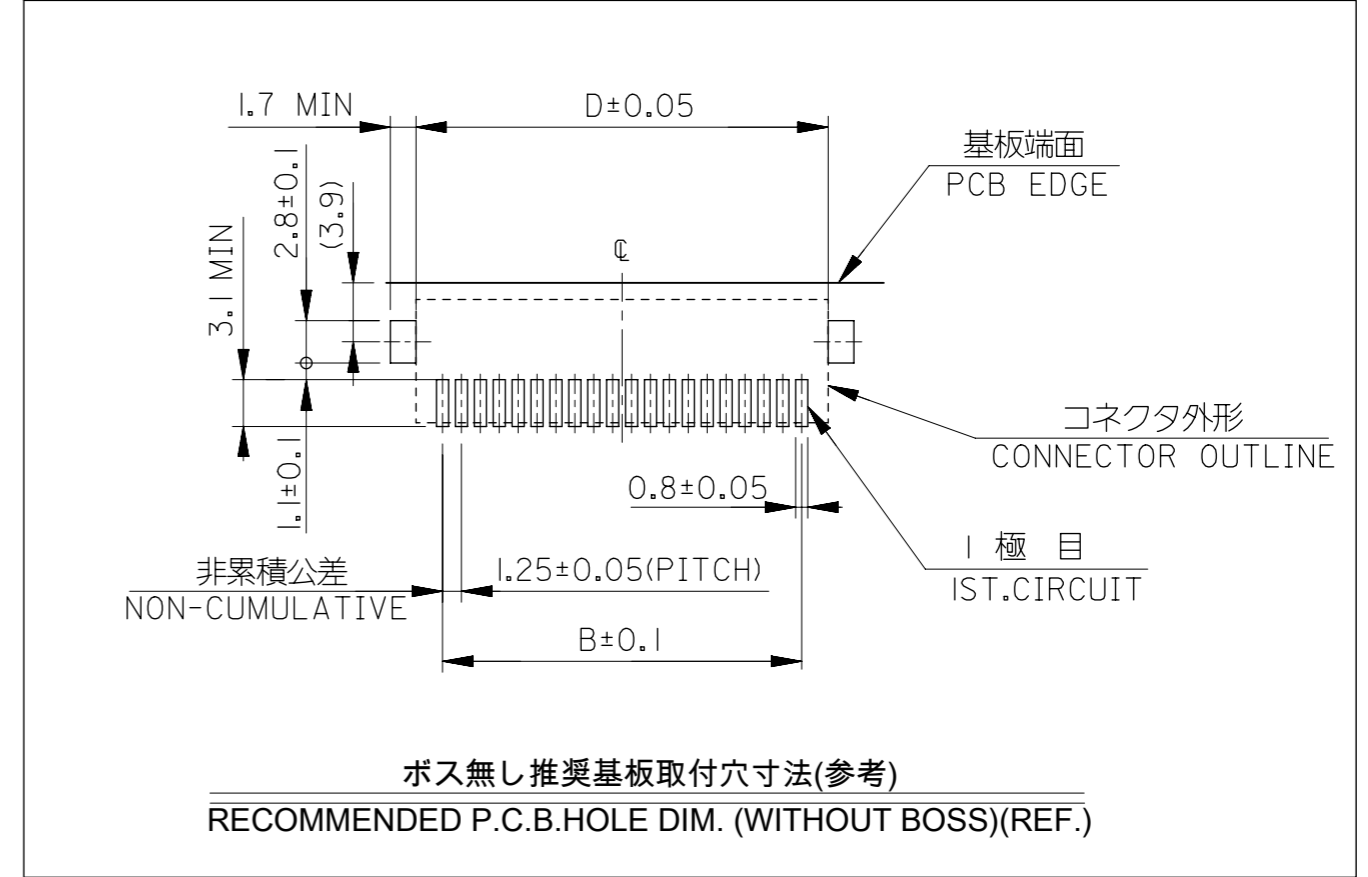
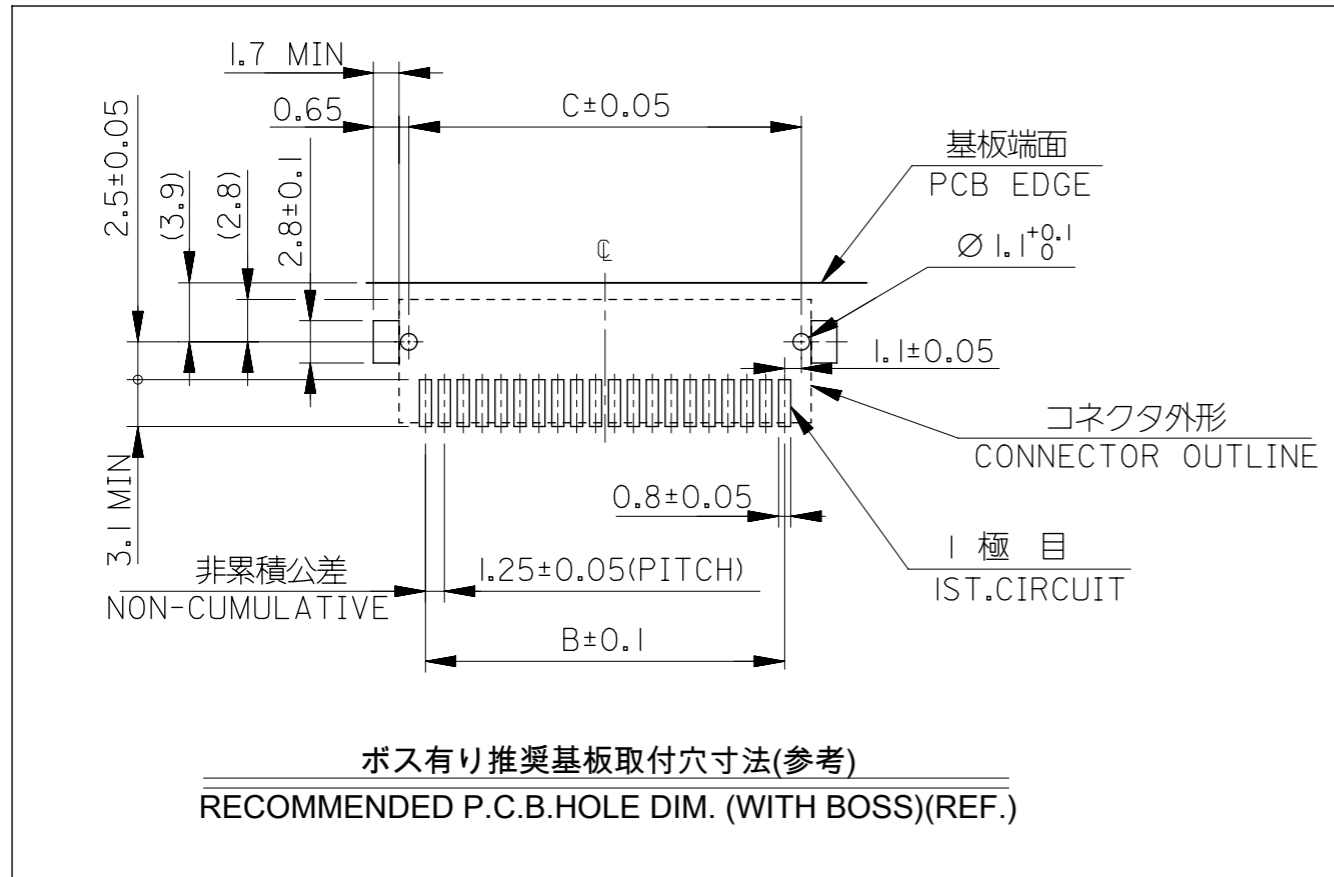

THIS DRAWING CONTAINS INFORMATION THAT IS PROPRIETARY TO MOLEX ELECTRONIC TECHNOLOGIES, LLC AND SHOULD NOT BE USED WITHOUT WRITTEN PERMISSION

REDRAWN AND REVISED EC NO: 112233 DRWN: QHE31 CHK'D: SAKIYAMA APPR: TKANEKO	2017/01/10	2017/01/16	GENERAL TOLERANCES (UNLESS SPECIFIED) ANGULAR TOL ± 3.0 ° 4 PLACES ± 0.2 3 PLACES ± 0.2 2 PLACES ± 0.2 1 PLACE ± 0.2 0 PLACES ± 0.2 DRAFT WHERE APPLICABLE MUST REMAIN WITHIN DIMENSIONS	DIMENSION UNITS	SCALE	
	MM	4:1		DRWN BY	DATE	
	QHE31	2017/01/10		CHK'D BY	DATE	
	SAKIYAMA	2017/01/16		APPR BY	DATE	
	TKANEKO	2017/01/16		DRAWING SIZE	THIRD ANGLE PROJECTION	
	A3			SERIES	MATERIAL NUMBER	
A	REV	55456	SEE TABLE OF SHEET 1			
RELEASE STATUS	RELEASE DATE	DOCUMENT NUMBER		DOC TYPE	DOC PART	SHEET NUMBER
		554560250		PSD	000	2 OF 2

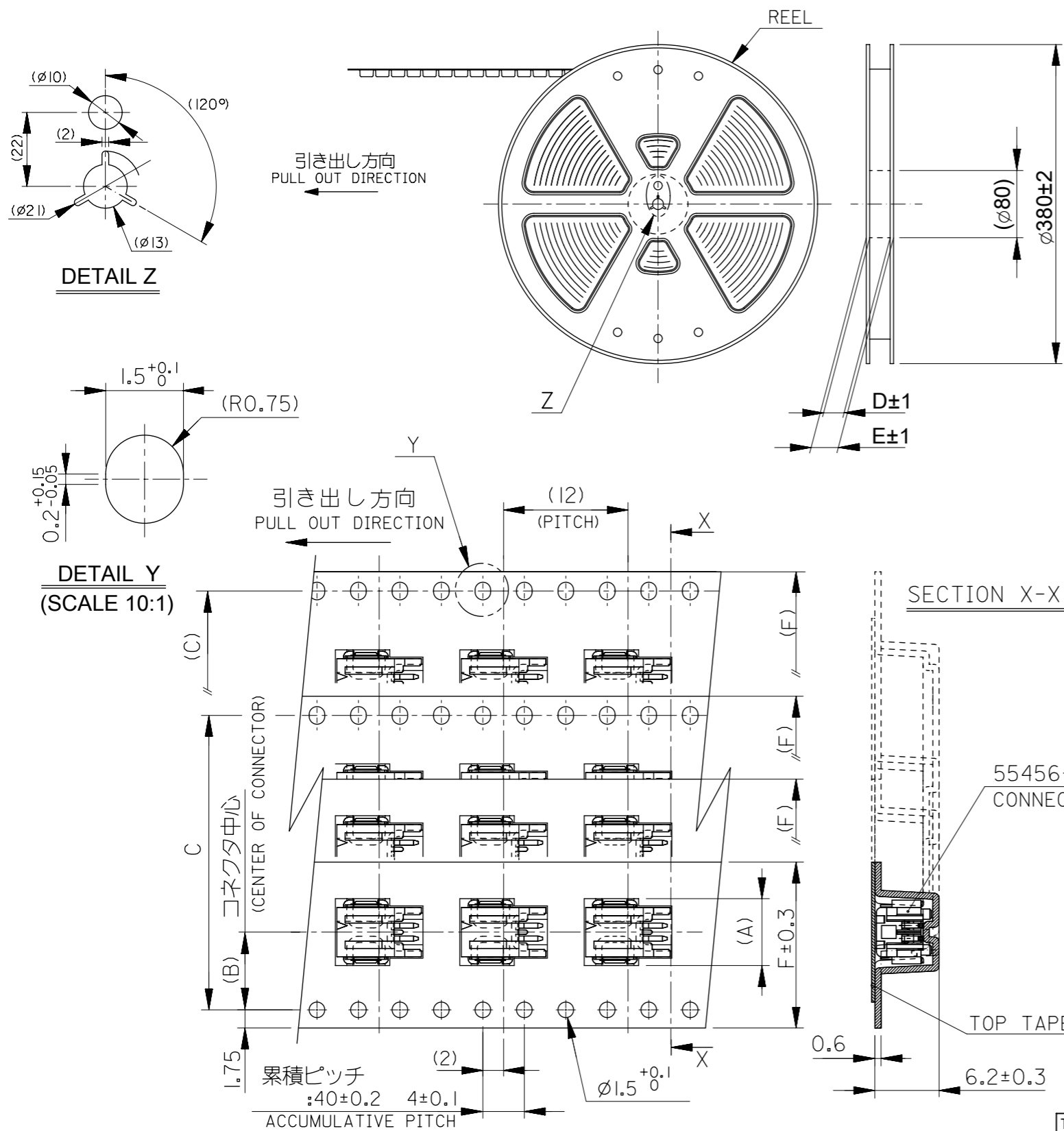

注記
NOTES

- 製品番号55456-****の詳細寸法については、554560250 PSD 000を参考下さい。
IN THE PACKAGE, PART NO. 55456-**** DETAILED DIMENSION, SEE 554560250 PSD 000
- 梱包数量：1250個/リール
NUMBER OF CONNECTORS：1250 PCS/REEL
- リードテープ長さ
LEAD TAPE LENGTH

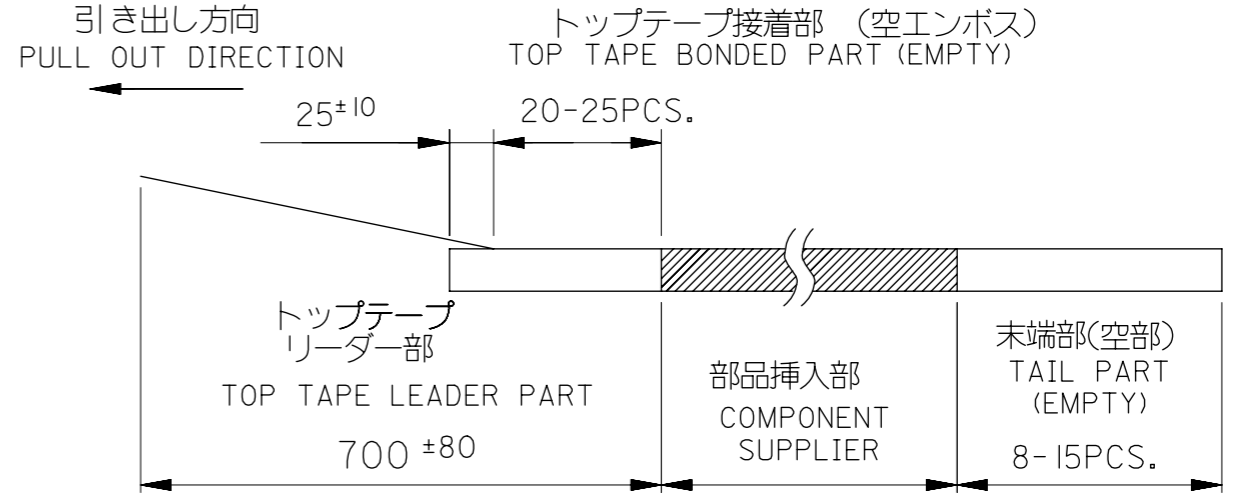

- トップテープの剥離強度：0.1~1.3N (10~130 gf)(剥離方向は下図参照)
剥離速度：300mm/min(参考)
PEEL-OFF FORCE OF TOP TAPE：0.1~1.3N (10~130 gf)(PEELING DIRECTION AS SHOWN IN FOLLOWING FIG.) PEEL-OFF SPEED：300mm/min(REF.)
尚、本規格値は、出荷時に適用。(但し、輸送時に剥離が発生しない事。)
THIS REQUIREMENT SHOULD BE APPLIED AT SHIPMENT (PEEL OFF SHOULD NOT BE ALLOWED, DURING TRANSPORTATION)

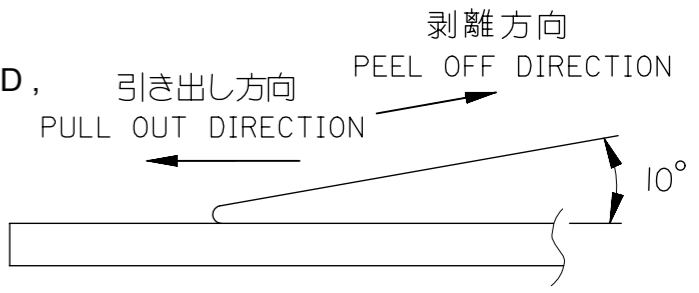

- 材料
MATERIAL
キャリアテープ：ポリプロピレン
CARRIER TAPE：POLYPROPYLENE
トップテープ：PET, PE, PEF
TOP TAPE：PET, PE, PEF
リール：ポリスチレン
REEL：POLYSTYRENE
- 本製品は55456-**19/**39/**79/**89の鉛フリー品である。
THIS PRODUCT IS LEAD FREE OF 55456-**19/**39/**79/**89.
- ELV及びRoHS適合品
ELV AND RoHS COMPLIANT

THIS DRAWING CONTAINS INFORMATION THAT IS PROPRIETARY TO MOLEX ELECTRONIC TECHNOLOGIES, LLC AND SHOULD NOT BE USED WITHOUT WRITTEN PERMISSION

REDRAWN AND REVISED EC NO: 112233 DRWN: QHE31 CHK'D: SAKIYAMA APPR: TKANEKO	2017/01/05	GENERAL TOLERANCES (UNLESS SPECIFIED)	DIMENSION UNITS	SCALE		
	2017/01/16		MM	2:1		
	2017/01/16		DRWN BY	DATE		QHE31 2017/01/05
	2017/01/16		CHK'D BY	DATE		SAKIYAMA 2017/01/16
A	REV	4 PLACES ± 0.2	APPR BY	DATE	PRODUCT CUSTOMER DRAWING SERIES: 55456 MATERIAL NUMBER: SEE TABLE OF SHEET 2 CUSTOMER:	
		3 PLACES ± 0.2	TKANEKO	2017/01/16		
		2 PLACES ± 0.2	DRAWING SIZE	THIRD ANGLE PROJECTION		554560259 PSD 000 1 OF 2
		1 PLACE ± 0.2	A3			
		0 PLACES ± 0.2	DRAFT WHERE APPLICABLE MUST REMAIN WITHIN DIMENSIONS			

RELEASE STATUS	RELEASE DATE
----------------	--------------

44	49.4	45.4	40.4	20.2	28.95	55456-2060	55456-2069	55456-2099	55456-2050	55456-2059	55456-2029	20
					27.7	55456-1960	55456-1969	—#—	55456-1950	55456-1959	—#—	19
					26.45	55456-1860	55456-1869	55456-1899	55456-1850	55456-1859	55456-1829	18
					25.2	55456-1760	55456-1769	—#—	55456-1750	55456-1759	—#—	17
					23.95	55456-1660	55456-1669	55456-1699	55456-1650	55456-1659	55456-1629	16
32	37.4	33.4	28.4	14.2	22.7	55456-1560	55456-1569	—#—	55456-1550	55456-1559	—#—	15
					21.45	55456-1460	55456-1469	—#—	55456-1450	55456-1459	—#—	14
					20.2	55456-1360	55456-1369	55456-1399	55456-1350	55456-1359	55456-1329	13
					18.95	55456-1260	55456-1269	55456-1299	55456-1250	55456-1259	—#—	12
					17.7	55456-1160	55456-1169	55456-1199	55456-1150	55456-1159	55456-1129	11
24	29.4	25.4	—#—	11.5	16.45	55456-1060	55456-1069	55456-1099	55456-1050	55456-1059	—#—	10
					15.2	55456-0960	55456-0969	—#—	55456-0950	55456-0959	—#—	9
					13.95	55456-0860	55456-0869	—#—	55456-0850	55456-0859	—#—	8
					12.7	55456-0760	55456-0769	55456-0799	55456-0750	55456-0759	55456-0729	7
					11.45	55456-0660	55456-0669	—#—	—#—	—#—	—#—	6
					10.2	55456-0560	55456-0569	55456-0599	55456-0550	55456-0559	55456-0529	5
					8.95	55456-0460	55456-0469	55456-0499	55456-0450	55456-0459	55456-0429	4
16	21.4	17.4	—#—	7.5	7.7	55456-0360	55456-0369	—#—	—#—	—#—	—#—	3
					6.45	55456-0260	55456-0269	55456-0299	55456-0250	55456-0259	—#—	2
F キャリアー テープ幅 TAPE WIDTH	E	(D)	(C)	(B)	(A)	CONNECTOR	エンボス梱包品 製品番号 MATERIAL NO. EMBS TAPE PKG	ハイバリア梱包品 製品番号 MATERIAL NO. HBB PKG	CONNECTOR	エンボス梱包品 製品番号 MATERIAL NO. EMBS TAPE PKG	ハイバリア梱包品 製品番号 MATERIAL NO. HBB PKG	極数 CKT.SIZE
							MODEL NO. :55456-**69	MODEL NO. :55456-**99		MODEL NO. :55456-**59	MODEL NO. :55456-**29	
							ボス無し WITHOUT BOSS			ボスあり WITH BOSS		

THIS DRAWING CONTAINS INFORMATION THAT IS PROPRIETARY TO MOLEX ELECTRONIC TECHNOLOGIES, LLC AND SHOULD NOT BE USED WITHOUT WRITTEN PERMISSION

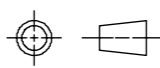
REDRAWN AND REVISED EC NO: 112233 DRWN: QHE31 CHK'D: SAKIYAMA APPR: TKANEKO	2017/01/05	GENERAL TOLERANCES (UNLESS SPECIFIED)		DIMENSION UNITS	SCALE		
	2017/01/16	ANGULAR TOL ± 3.0 °		MM	1:1		
	2017/01/16	4 PLACES ± 0.2	DRWN BY	DATE			MINI MI2 1-ROW R/A SMT EMBOSSED TAPE PACKAGE
		3 PLACES ± 0.2	QHE31	2017/01/05			
		2 PLACES ± 0.2	CHK'D BY	DATE			PRODUCT CUSTOMER DRAWING
	1 PLACE ± 0.2	SAKIYAMA	2017/01/16				
	0 PLACES ± 0.2	APPR BY	DATE		SERIES: 55456 MATERIAL NUMBER: SEE TABLE OF SHEET 2 CUSTOMER:		
		DRAFT WHERE APPLICABLE MUST REMAIN WITHIN DIMENSIONS		DRAWING SIZE	THIRD ANGLE PROJECTION	DOCUMENT NUMBER: 554560259 DOC TYPE: PSD DOC PART: 000 SHEET NUMBER: 2 OF 2	
A	REV			A3			

RELEASE STATUS	RELEASE DATE
----------------	--------------