

Description	Material	Finish
Body	Brass	Nickel
Pin	BE CU	Gold
Insulation	PTFE	N/A
Washer	Brass	Nickel
Nut	Brass	Nickel

REVISIONS			
REV	DESCRIPTION	DATE	APPV
B	Added new title block; updated footprint dimensions	13-MAR-12	BPM
C	Updated materials	10-JUL-12	SAH

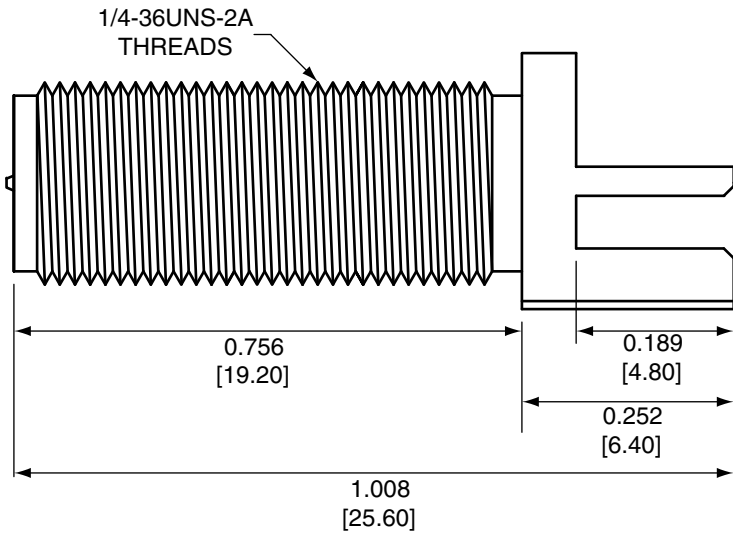

SIDE VIEW

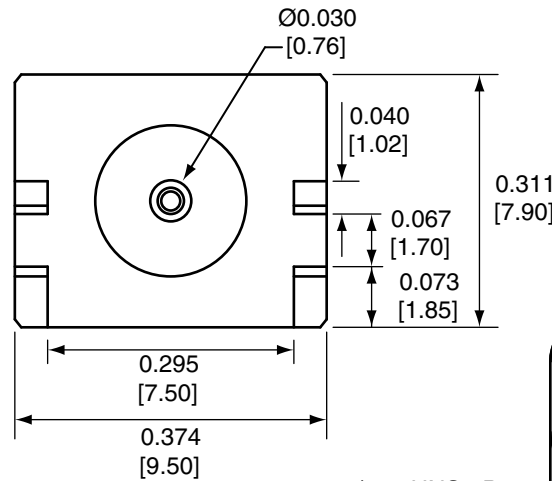

BACK VIEW

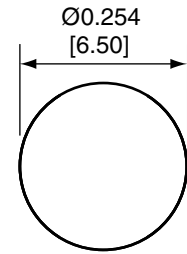

RECOMMENDED MOUNTING HOLE

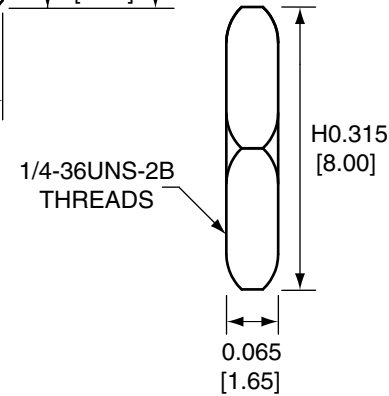

NUT

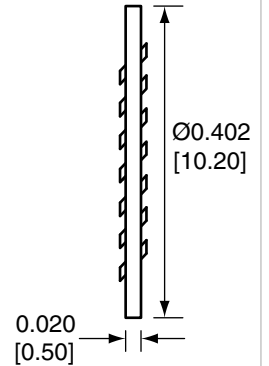

WASHER

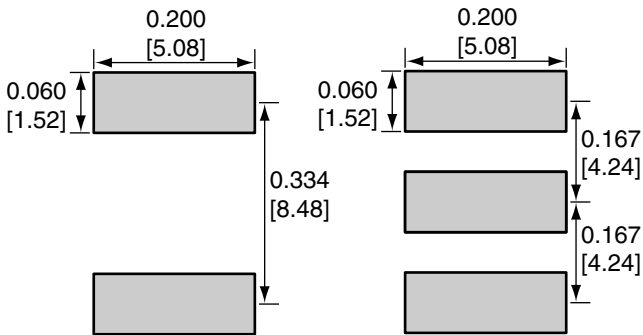

BOTTOM

TOP

RECOMMENDED FOOTPRINT

NOTES: (UNLESS OTHERWISE SPECIFIED)

1. ALL DIMENSIONS ARE IN INCHES [mm].
2. DIMENSIONS APPLY AFTER FINISHING.
3. MANUFACTURE TO BE COMPLIANT WITH EU RoHS DIRECTIVE.
4. SAFETY BREAK ALL SHARP CORNERS AND EDGES .02 MAXIMUM.

WARNING: THIS DRAWING CONTAINS PROPRIETARY INFORMATION THAT IS THE SOLE PROPERTY OF LINX TECHNOLOGIES, AND SHALL BE TREATED AS SUCH. NO DISCLOSURE OR REPRODUCTION OF THIS DOCUMENT IS PERMITTED, IN WHOLE OR IN PART, WITHOUT THE EXPRESS WRITTEN PERMISSION OF LINX TECHNOLOGIES OR ITS DESIGNATED AGENTS.

MATERIAL:	TOLERANCES: .020 [0.50]-.200 [5.00]= ±.008 [0.20] .200 [5.00]-1.200 [30.00]= ±.016 [0.40] 1.20 [30.0]-4.75 [120.0]= ±.024 [0.60] 4.75 [120.0]-12.40 [315.0]= ±.040 [1.0]	PROJECTION:  ANGLES: ±1°
FINISH:	DRAWN: B.MURPHY	DT: 13-MAR-12
	ENGR: S.HOGAN	DT: 13-MAR-12

Linx

159 ORT LANE
MERLIN, OR 97532

TITLE: RP-SMA FEMALE EDGE MOUNT
FOR 0.062" THICK BOARD, EXTENDED

SIZE	DWG. NO.	REV
A	CONREV SMA003.062-L	C
SCALE: 2:1	DO NOT SCALE DRAWING	SHEET 1 OF 1