

Description

- Standard 7 x 5mm crystal oscillator in a ceramic package with a seam sealed metal lid, hermetically sealed.
- Model CFPS-72
- Model Issue number 12

Frequency Parameters

- Frequency 10.0MHz
- Frequency Stability $\pm 50.00\text{ppm}$
- Operating Temperature Range 0.00 to 70.00°C
- Ageing $\pm 3\text{ppm}$ per year max

Electrical Parameters

- Supply Voltage 5.0V $\pm 10\%$
- Current Draw 20.00mA

Output Details

- Output Compatibility HCMOS/TTL
- Drive Capability 50pF max
- Rise and Fall Time 10.0ns max
- Duty Cycle 45/55%

Output Control

- Standby Operation:
Logic '1' ($>70\% V_s$) to pad 1 enables oscillator output.
Logic '0' ($<30\% V_s$) to pad 1 disables oscillator output; the oscillator output goes to the high impedance state.
No connection to pad 1 enables oscillator output.
- Standby Current: 10 μA max

Noise Parameters

- Phase Jitter RMS : 350fs typical

Environmental Parameters

- Shock: MIL-STD-202, Method 213, Condition E.
- Vibration: MIL-STD-883, Method 2007, Condition A.

Compliance

- RoHS Status (2011/65/EU) Compliant
- REACH Status Compliant
- MSL Rating (JDEC-STD-033): Not Applicable

Packaging Details

- Pack Style: Reel Tape & reel in accordance with EIA-481-D
Pack Size: 1,000
- *Alternative packing option available*

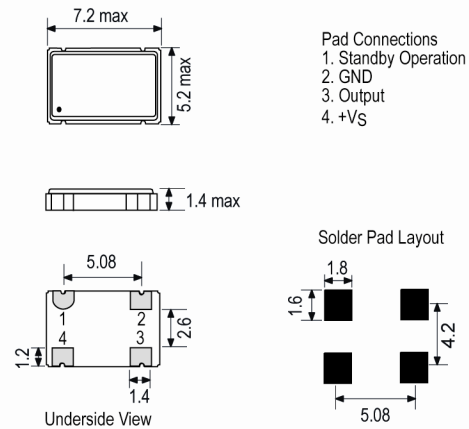
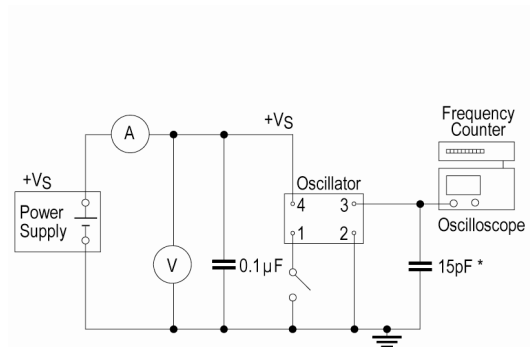
Outline (mm)

Test Circuit

* Inclusive of jigging and equipment capacitance

Sales Office Contact Details:

UK: +44 (0)1460 270200
Germany: 0800 1808 443

France: 0800 901 383
USA: +1.760.318.2824

Email: info@iqdfrequencyproducts.com
Web: www.iqdfrequencyproducts.com

Wave Form

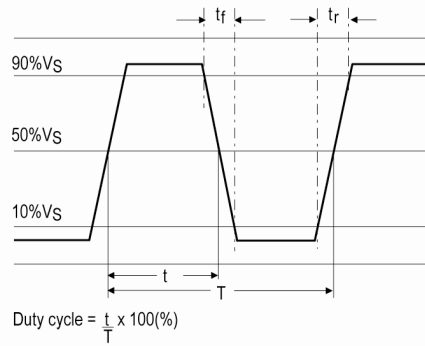

Sales Office Contact Details:

UK: +44 (0)1460 270200
Germany: 0800 1808 443

France: 0800 901 383
USA: +1.760.318.2824

Email: info@iqdfrequencyproducts.com
Web: www.iqdfrequencyproducts.com