

# COMPACT SHIELDED SMD POWER INDUCTOR FOR AUTOMOTIVE

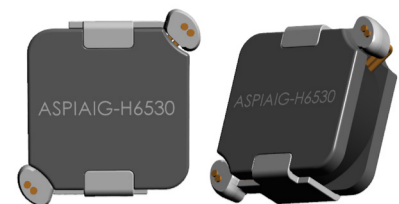

ASPIAIG-HXXXX SERIES

ASPIAIG-H6530: 7.1 x 6.5 x 3.0 mm  
ASPIAIG-H8540: 8.8 x 8.5 x 4.0 mm

RoHS/RoHS II Compliant

MSL = 1

## FEATURES

- Low profile 3mm height for compact applications
- Advanced and high reliability wire-wound construction
- Shielded construction reduces EMI
- Automotive grade power inductor
- TS-16949 qualified production
- PPAP level 3 support
- AEC-Q200 qualified with -40°C to 125°C operation
- Low DCR down to 3.5mΩ improves efficiency
- High saturation current up to 32A
- Compact 7.1 x 6.5mm or 8.8 x 8.5mm options

## APPLICATIONS

- Height restricted applications
- Automotive body electronics and comfort system
- Automotive infotainment and entertainment
- Automotive navigation
- Transportation
- Lighting, LED ballasts
- Industrial Internet of Things (IIoT)
- Industrial applications
- Solar power
- DC/DC converters and switch mode power supplies

## STANDARD SPECIFICATIONS

Operating Temperature	-40°C ~ +125°C
Storage Condition	-10°C ~ +40°C and R.H. 70% max

Part Number	Inductance	Tolerance	Self-resonant	DC Resistance	Saturation Current	Temperature Rise Current
	100kHz/1V		Min	Max (25°C)	Typ	Typ
Units	μH	%	MHz	mΩ	A	A
Symbol	L	M	SRF	DCR	Isat	Irms
ASPIAIG-H6530-R22	0.22	20	108	4.0	25.00	20.00
ASPIAIG-H6530-R33	0.33	20	78	5.1	23.00	17.50
ASPIAIG-H6530-R47	0.47	20	71	6.6	22.50	15.50
ASPIAIG-H6530-R68	0.68	20	57	8.7	18.00	13.45
ASPIAIG-H6530-R75	0.75	20	55	8.7	15.80	13.45
ASPIAIG-H6530-1R0	1.0	20	41	8.7	13.00	13.45
ASPIAIG-H6530-1R5	1.5	20	37	13.8	11.50	8.50
ASPIAIG-H6530-2R2	2.2	20	24	18.0	8.60	8.00
ASPIAIG-H6530-3R3	3.3	20	23	30.5	6.60	7.00
ASPIAIG-H6530-4R7	4.7	20	15	43.5	5.30	5.40
ASPIAIG-H6530-6R8	6.8	20	14	64.0	4.50	4.50
ASPIAIG-H6530-8R2	8.2	20	13	69.0	4.50	4.40
ASPIAIG-H6530-100	10.0	20	12	77.4	4.45	4.20
ASPIAIG-H6530-150	15.0	20	11	127.0	4.25	3.50
ASPIAIG-H6530-220	22.0	20	8	177.0	2.40	2.80
ASPIAIG-H8540-R47	0.47	20	57	3.5	32.0	11.3
ASPIAIG-H8540-1R0	1.0	20	49	6.5	20.0	8.4
ASPIAIG-H8540-1R5	1.5	20	38	7.7	17.0	7.6
ASPIAIG-H8540-2R2	2.2	20	29	12.0	14.0	6.1
ASPIAIG-H8540-3R3	3.3	20	24	19.9	15.0	4.9
ASPIAIG-H8540-4R7	4.7	20	19	27.6	12.5	4.2
ASPIAIG-H8540-5R6	5.6	20	17	30.6	11.0	3.9
ASPIAIG-H8540-6R8	6.8	20	15	37.4	8.0	3.8
ASPIAIG-H8540-8R2	8.2	20	14	46.8	8.5	3.7
ASPIAIG-H8540-100	10.0	20	12	53.9	8.0	3.5
ASPIAIG-H8540-150	15.0	20	10	74.4	6.5	3.0
ASPIAIG-H8540-220	22.0	20	7	108.6	4.2	2.5
ASPIAIG-H8540-330	33.0	20	6	178.8	4.2	2.0

# COMPACT SHIELDED SMD POWER INDUCTOR FOR AUTOMOTIVE



ASPIAIG-H6530: 7.1 x 6.5 x 3.0 mm  
 ASPIAIG-H8540: 8.8 x 8.5 x 4.0 mm

ASPIAIG-HXXXX SERIES

RoHS/RoHS II Compliant

MSL = 1

## PART NUMBER IDENTIFICATION

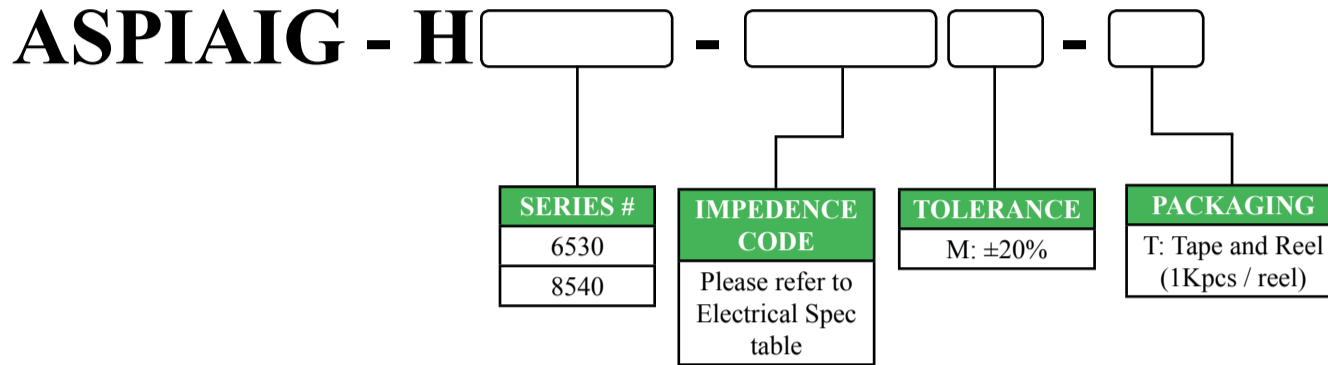

## ELECTRICAL CHARACTERISTICS

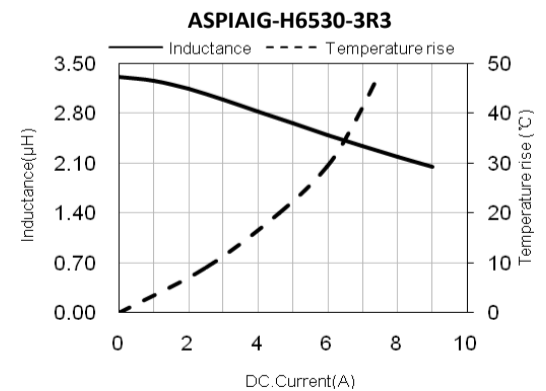
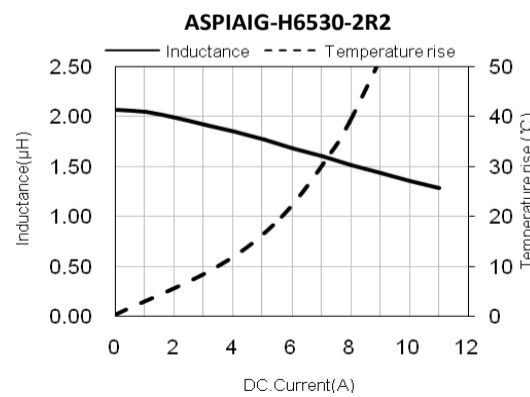
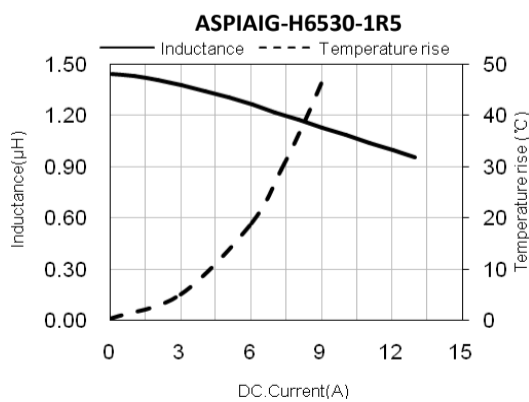
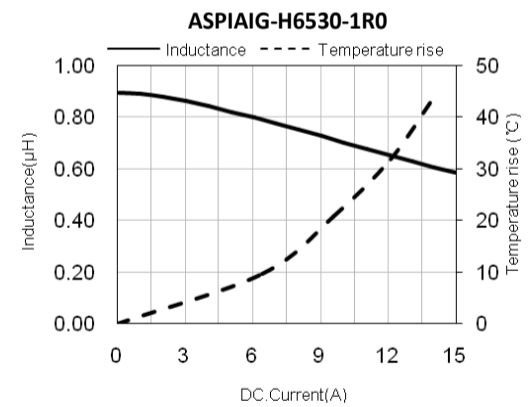
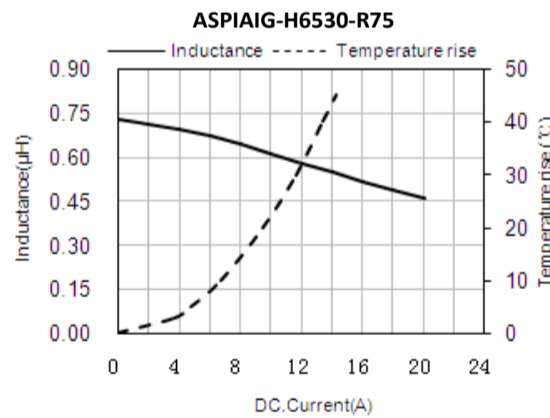
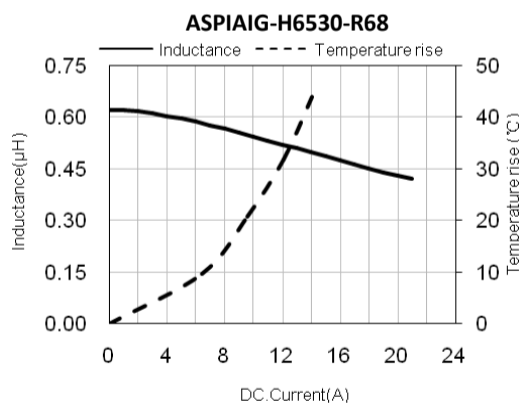
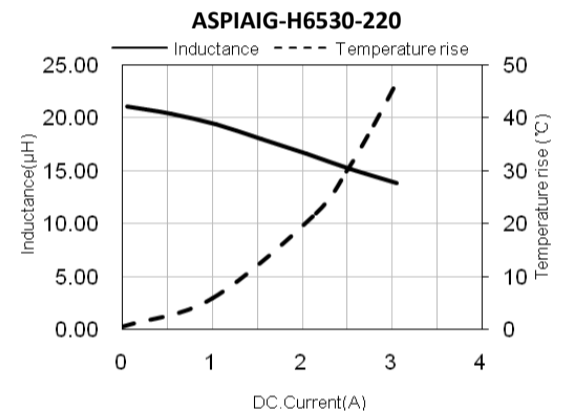
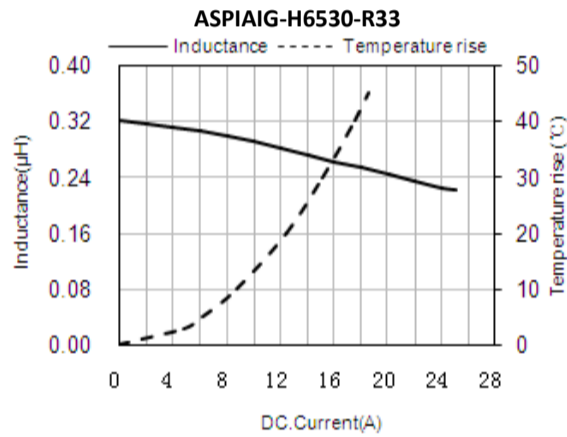
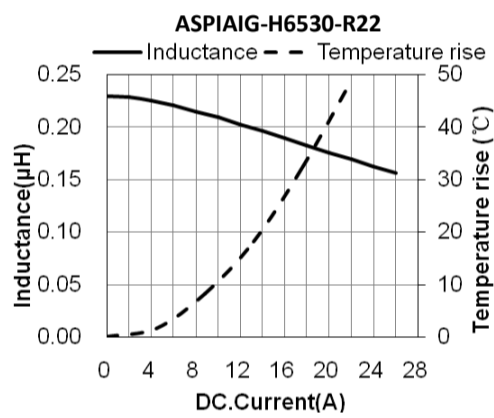

REVISED: 12.21.2016

# COMPACT SHIELDED SMD POWER INDUCTOR FOR AUTOMOTIVE



ASPIAIG-HXXXX SERIES

ASPIAIG-H6530: 7.1 x 6.5 x 3.0 mm  
ASPIAIG-H8540: 8.8 x 8.5 x 4.0 mm

RoHS/RoHS II Compliant

MSL = 1

## ELECTRICAL CHARACTERISTICS

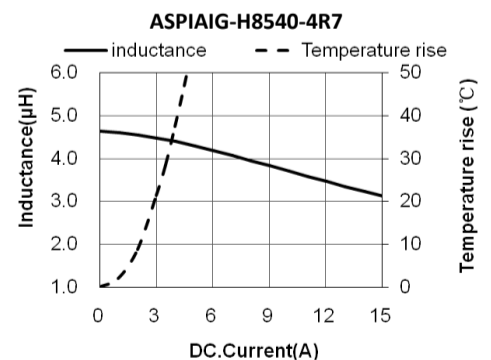
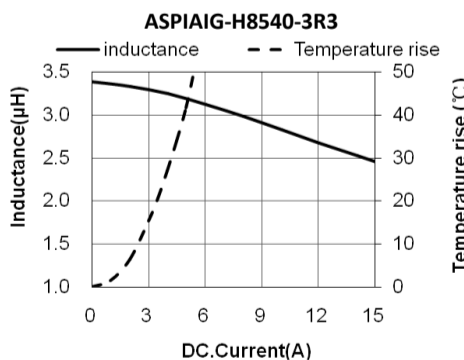
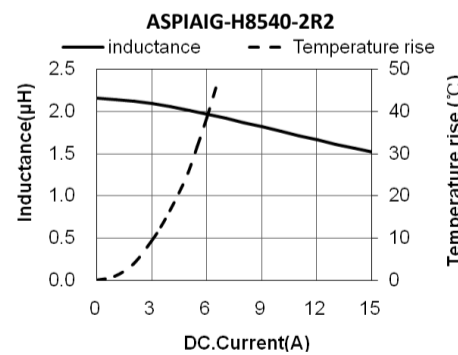
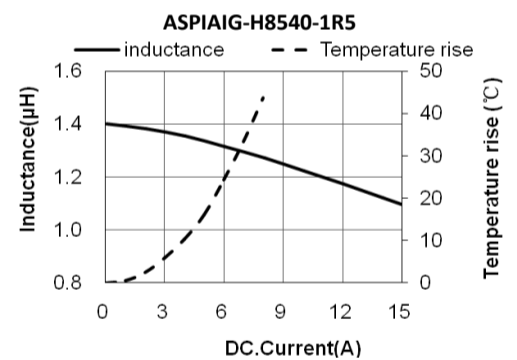
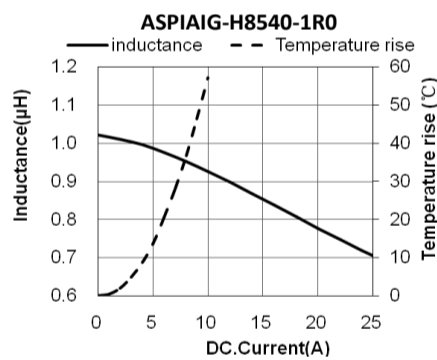
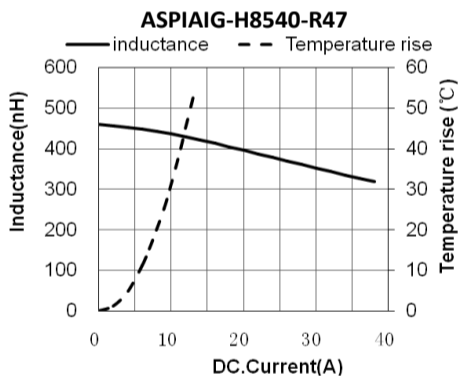
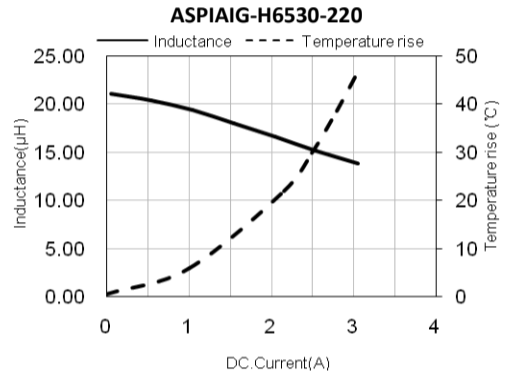
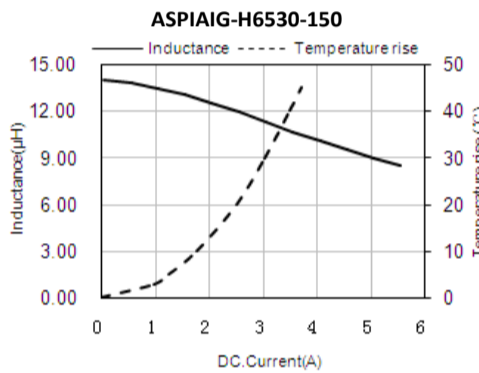
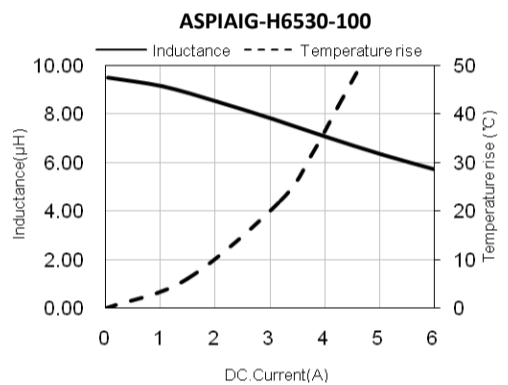
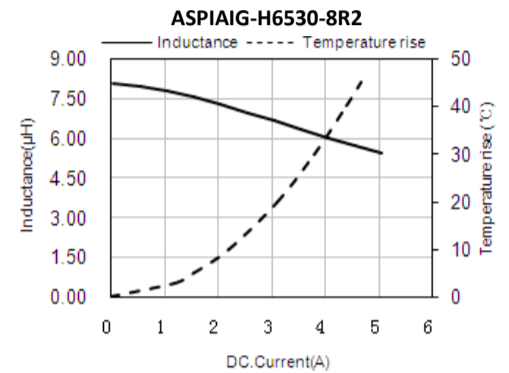
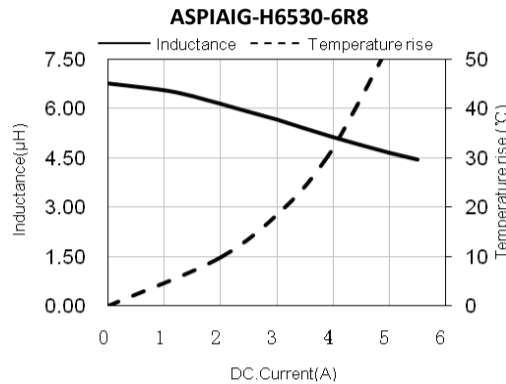
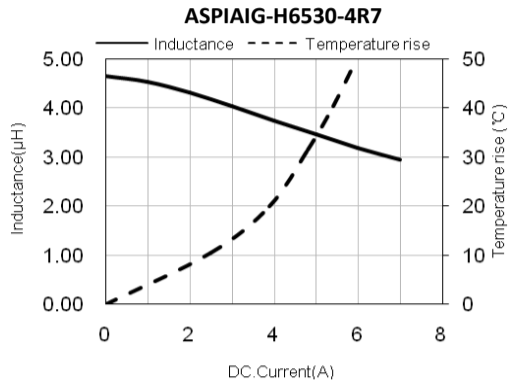

# COMPACT SHIELDED SMD POWER INDUCTOR FOR AUTOMOTIVE

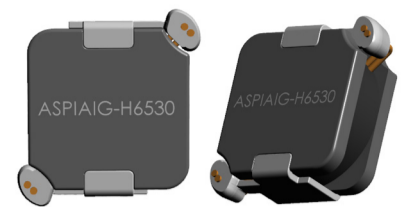

ASPIAIG-H6530: 7.1 x 6.5 x 3.0 mm  
ASPIAIG-H8540: 8.8 x 8.5 x 4.0 mm

**Pb** RoHS/RoHS II Compliant  
MSL = 1

## ASPIAIG-HXXXX SERIES

### ELECTRICAL CHARACTERISTICS

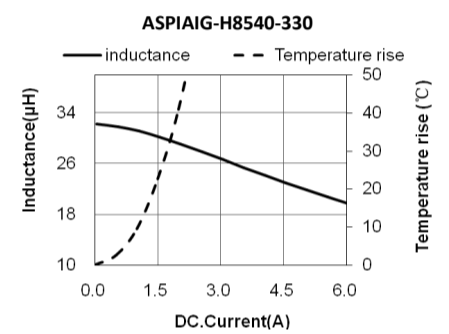
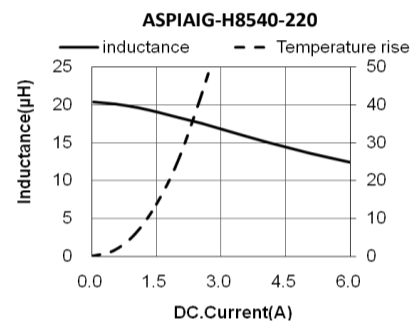
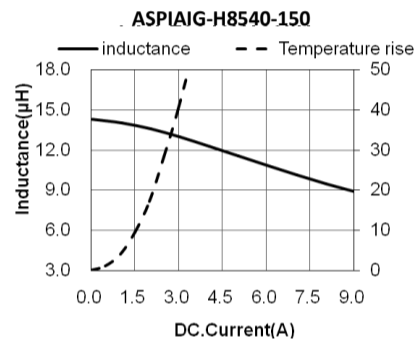
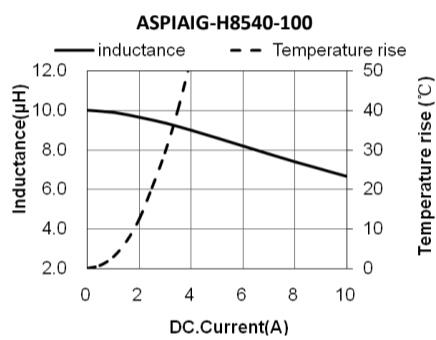
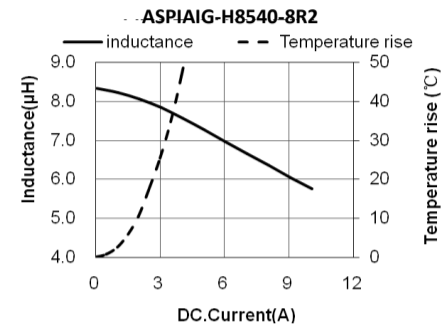
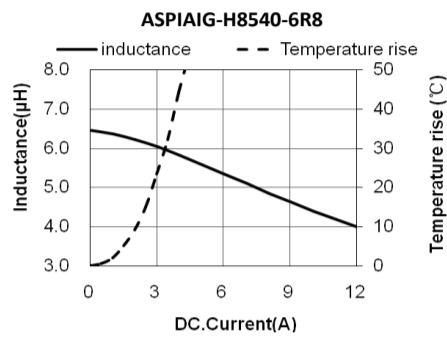
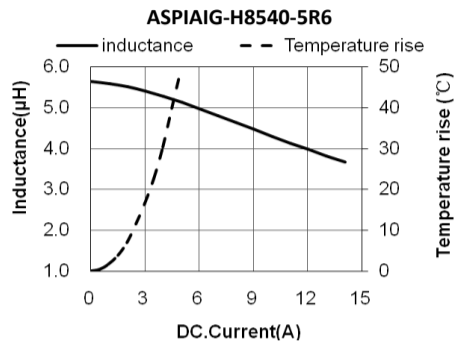

### MECHANICAL DIMENSIONS

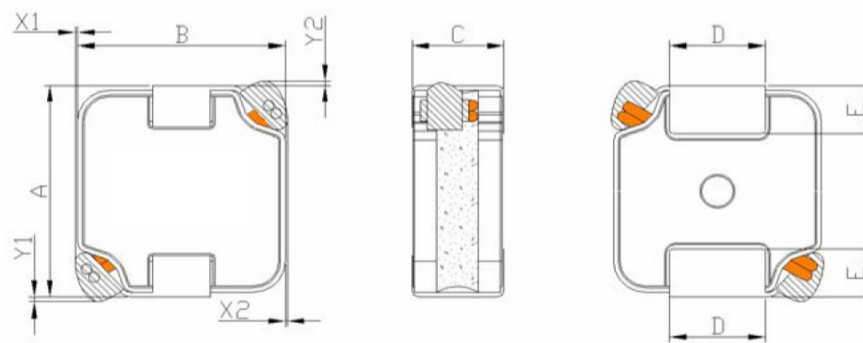

SERIES	A	B	C	D	E	X1	X2	Y1	Y2
ASPIAIG-H6530	7.1 ± 0.3	6.5 ± 0.3	3.0 ± 0.2	3.2 ± 0.3	1.55 ± 0.3			0.5 MAX	
ASPIAIG-H8540	8.5 ± 0.3	8.2 ± 0.3	4.0 MAX	3.9 ± 0.3	1.9 ± 0.3			0.5 MAX	

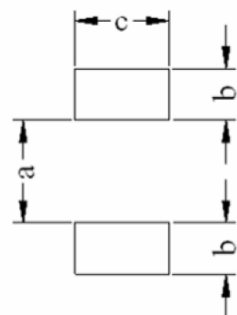

SERIES#	a Typ	b Typ	c Typ
ASPIAIG-H6530	3.7	1.85	3.4
ASPIAIG-H8540	3.8	2.4	4.1

# COMPACT SHIELDED SMD POWER INDUCTOR FOR AUTOMOTIVE



ASPIAIG-HXXXX SERIES

ASPIAIG-H6530: 7.1 x 6.5 x 3.0 mm  
ASPIAIG-H8540: 8.8 x 8.5 x 4.0 mm

RoHS/RoHS II Compliant

MSL = 1

## REFLOW PROFILE

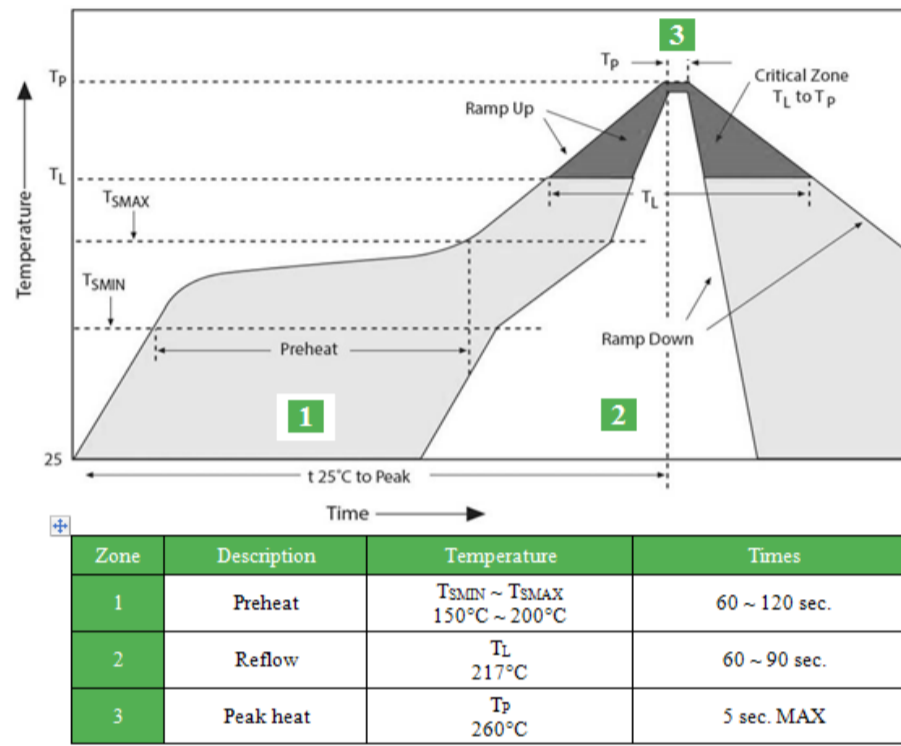

## PACKAGING

TAPE AND REEL: 1000 PCS/REEL

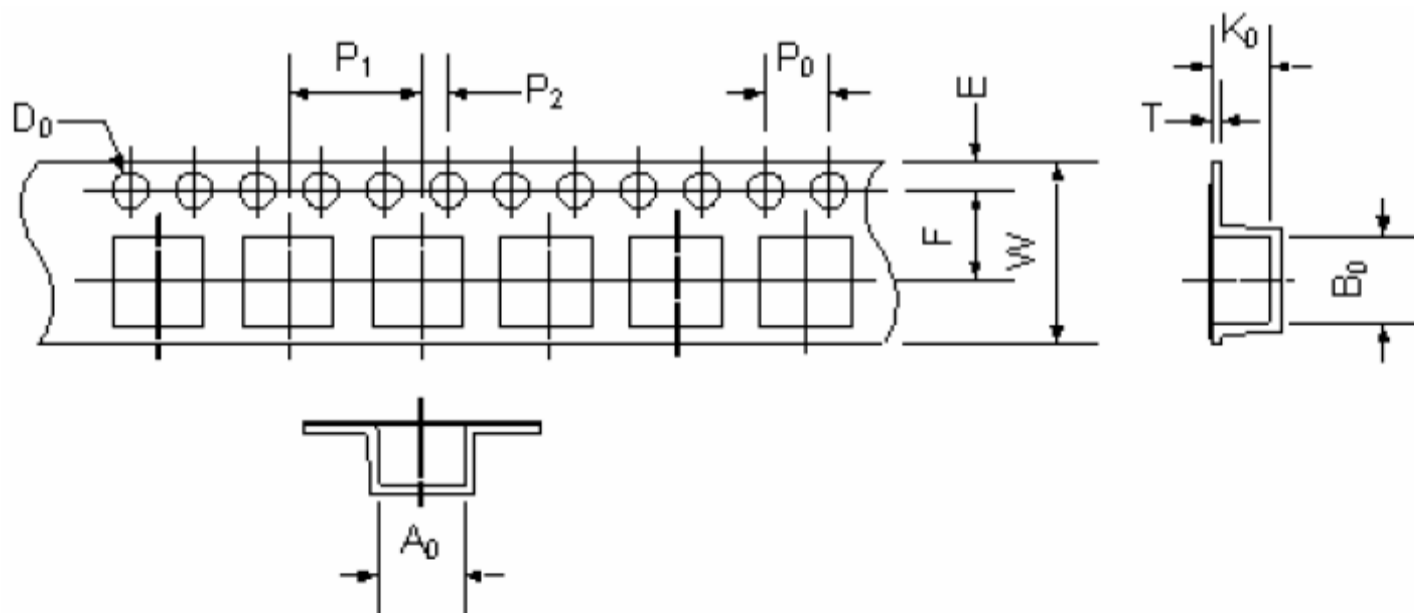

SERIES#	W	E	F	P0	P1	P2	D0	A0	B0	T	K0
ASPIAIG-H6530	16.0±0.3	1.75±0.1	7.5±0.1	4.0±0.1	12.0±0.1	2.0±0.1	1.5+0.1/-0.0	7.6±0.1	7.4±0.1	0.4±0.03	3.6±0.1
ASPIAIG-H8540	16.0±0.3	1.75±0.1	7.5±0.1	4.0±0.1	12.0±0.1	2.0±0.1	1.5+0.1/-0.0	8.9±0.1	8.6±0.1	0.5±0.05	4.2±0.1

# COMPACT SHIELDED SMD POWER INDUCTOR FOR AUTOMOTIVE

ASPIAIG-HXXXX SERIES

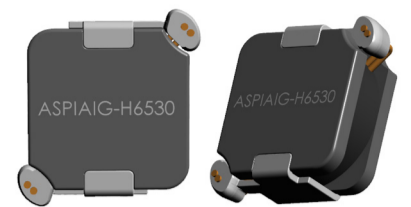

ASPIAIG-H6530: 7.1 x 6.5 x 3.0 mm  
ASPIAIG-H8540: 8.8 x 8.5 x 4.0 mm

PACKAGING: DIRECTION OF ROLLING

RoHS/RoHS II Compliant

MSL = 1

Tape and Reel: 1000 pcs/reel

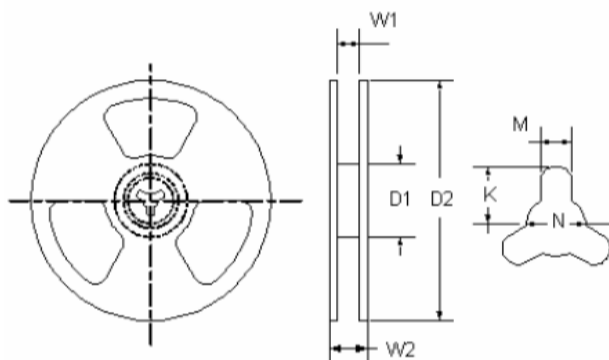
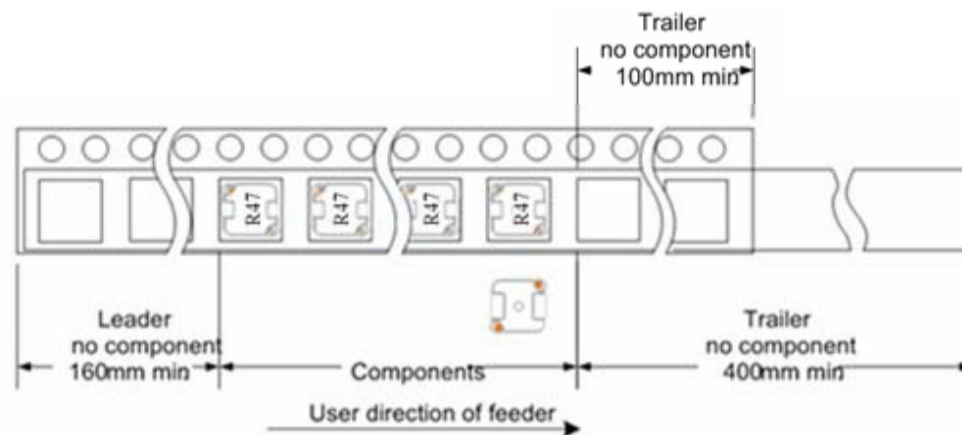

D1	100 ± 0.5
D2	330 ± 0.1
W1	16.4 +0.2 / -0.0
W2	22.4 MAX
K	10.75 ± 0.2
M	2.3 ± 0.2
N	13.0 +0.2 / -0.0

## NOTES

1. The parts are manufactured in accordance with this specification. If other conditions and specifications which are required for this specification, please contact ABRACON for more information.
2. ABRACON will supply the parts in accordance with this specification unless we receive a written request to modify prior to an order placement.
3. In no case shall ABRACON be liable for any product failure from in appropriate handling or operation of the item beyond the scope of this specification.
4. When changing your production process, please notify ABRACON immediately.
5. ABRACON LLC's products are COTS – Commercial-Off-The-Shelf products; suitable for Commercial, Industrial and, where designated, Automotive Applications. ABRACON's products are not specifically designed for Military, Aviation, Aerospace, Life-dependant Medical applications or any application requiring high reliability where component failure could result in loss of life and/or property. For applications requiring high reliability and/or presenting an extreme operating environment, written consent and authorization from ABRACON Corporation is required. Please contact ABRACON Corporation for more information.
6. All specifications and Marking will be subject to change without notice.