



Energy Saving Products

101 N.Sepulveda Blvd, EL Segundo 90245 California, USA

# IRAUDPS3-30V

## **+/-30V Power Supply for Class-D Audio Amplifier Reference Design User Guide**

# Table of Contents

1	INTRODUCTION.....	3
2	IRS27951/2 DESCRIPTION.....	3
3	EVALUATION BOARD SPECIFICATIONS.....	4
3.1	Board Description.....	5
3.2	Schematic.....	6
3.3	Board PCB Layout.....	7
3.4	Bill of Materials.....	8
4	EVALUATION BOARD OPERATING PROCEDURE.....	10
4.1	Load Connection.....	11
4.2	AC Input.....	11
4.3	IRS27952 DC Supply Voltage.....	11
4.4	Disconnect the Board.....	11
5	SYSTEM PERFORMANCE CHARACTERIZATION.....	12
5.1	Primary Waveforms.....	12
5.2	Dynamic Load Response and Regulation Waveforms.....	13
	Test Conditions: Full Load (2A to +B and -B); No Load (0A).....	13
5.3	Output Waveforms with Audio Amplifier Load.....	14
5.4	Output Ripple.....	18
5.5	Efficiency.....	18
5.6	Thermal Data.....	19
6	Transformer Spec.....	20
6.1	Electrical Diagram.....	20
6.2	Resonant Transformer Winding Characteristics.....	20

# 1 INTRODUCTION

This document details the performance and test procedure of IRAUDPS3-30V Reference Design, featuring the IRS27952S Resonant Half Bridge controller. The document includes schematic diagram, PCB layout, test setup, test procedure, and test results.

## 2 IRS27951/2 DESCRIPTION

The IRS2795(1,2) is an 8 pin, high-voltage, double-ended controller specific for the resonant half-bridge topology. It provides 50% complementary duty cycle; the high-side and the low-side devices are driven 180° out-of-phase for exactly the same time. The IC incorporates additional protection features for robust operation and provides a high performance solution while minimizing external components and printed circuit board area.

The IC enables the designer to externally program all the following features using a 2 pin oscillator - operating frequency range (minimum and maximum frequency), startup frequency, dead time, soft-start time and sleep mode. Each of these functions are programmed as follows –

The minimum frequency is programmed using RT and CT.

The dead time is programmed using CT.

RSS and CSS program the converter soft-start time.

RSS//RT and CT program the converter start-up frequency.

The converter maximum frequency is set by (Rmax//RT) and CT.

Sleep mode is initiated by pulling the CT/SD to COM.

At start-up, to prevent uncontrolled inrush current, the switching frequency starts from a programmable maximum value and progressively decays until it reaches the steady-state value determined by the control loop. This frequency shift is nonlinear to minimize output voltage overshoot and its duration is programmable as well. Output voltage regulation is obtained by modulating the operating frequency. An externally programmable dead time is inserted between the turn-OFF of one switch and the turn-ON of the other one allows device zero-voltage turn-on transitions.

IRS2795 uses IR's proprietary high-voltage technology to implement a VS sensing circuitry that monitors the current through the low-side half bridge MOSFET for short circuit faults. By using the  $R_{\text{DS(on)}}$  of the low-side MOSFET, the IRS2795 eliminates the need for an additional current sensing resistor, filter and current-sensing pin. This protection feature is latched and the thresholds are fixed at **2V for IRS27951** and **3V for IRS27952**.

Finally, the controller IC also features a micro power startup current ( $I_{\text{CC}} < 100\mu\text{A}$ ) and a user initiated sleep mode during which the IC power consumption is less than 200 $\mu\text{A}$  (@  $V_{\text{CC}} = 15\text{V}$ ). The sleep mode function allows system designs with reduced standby power consumption and can be used to meet stringent energy standards from Blue Angel, Energy Star etc.

### 3 EVALUATION BOARD<sup>1</sup> SPECIFICATIONS

<b>AC Voltage Range</b>	88V-132V or 176V-264V With user selectable 110/220V jumper <b>The jumper is configured for 110Vac input in default</b>
<b>AC Line Frequency</b>	47-63Hz
<b>Output Voltage</b>	+/-30V, 28V~32V regulation under 120W load. +15%/-25%, 22.5V~34.5V under maximum pulsed load
<b>Average Load</b>	60W, PS will be designed to thermally support this load
<b>5 Minutes Cont. Load</b>	120W, PS will be designed to electrically support this load
<b>Maximum Pulse Load</b>	200W, 20Hz sinusoid pulse, at Nominal Vin and +20% Vin 150W, 20Hz sinusoid pulse, at -20% Vin (Note <sup>2</sup> ) This load has to be managed by the output capacitors
<b>Efficiency</b>	>88% at 120W load
<b>Converter Switching Frequency Range</b>	60-190 kHz
<b>Maximum Ambient Operating Temperature</b>	50°C
<b>Board Size</b>	3"x5"x1.5" Main board: Single layer PCB Control board: Double layer PCB

**There are high voltages present whenever the board is energized and proper precautions should be taken to avoid potential shock and personal injury.**

<sup>1</sup> Please note that EMI measurements have not been performed on this evaluation board. The primary goal of this board is to demonstrate the performance of the IRS27952 controller IC.

<sup>2</sup> The LLC resonant half-bridge has narrow line regulation range. At low line the capability of peak power is folded back.

## 3.1 Board Description

The evaluation board consists of a front-end AC-DC rectifier stage cascaded with a half-bridge resonant DC-DC converter with +/-30V output voltage rails.

The front end is a conventional pi type EMI filter, followed by bridge rectifier stage. Two 200V/680uF bulk capacitors are connected in series to provide stable DC bus voltage. The rectifier can be configured as full bridge rectifier for 220Vac input, or voltage doubler rectifier for 110Vac input.

The downstream converter is a multi-resonant half bridge LLC converter whose control is implemented with the IRS27952 controller HVIC (U101 on the control board). The controller drives the two half-bridge MOSFETs with a 50 percent fixed duty cycle with pre-defined dead-time. Output voltage regulation is achieved by changing the switching frequency according to the feedback signal.

IRS27952 is self-supplied in this reference design. The startup resistors R7 and R7A~C provide startup current to IRS27952 during power up and charge the Vcc capacitors (CP3 and C5 on the main board). Once Vcc voltage exceeds Vccuv+ threshold, IRS27952 starts operation and the auxiliary winding of power transformer can provide bias to the IC. The voltage of auxiliary winding could vary a lot when load changes from 0A to full load, so a linear regulator – Z101, R101 and Q101 (on the control board) – is used to keep Vcc regulated at 12V.

The transformer uses the magnetic integration approach, incorporating the resonant series and shunt inductances in the power transformer. The transformer configuration chosen for the secondary winding is center-tap. The feedback loop is implemented by means of a classical configuration using a TL431 (U104) to adjust the current in the optocoupler PC817 (U103). The optocoupler transistor modulates the current from the RT pin of the controller IC to modulate the switching frequency, thus achieving output voltage regulation.

The secondary side has two center-tapped windings for +30V and -30V output. Each rail has full wave rectifier and filter with the return connected to center-tap. The feedback loop is configured to regulate the rail to rail voltage to 60V. The balance of +30V and -30V is achieved by the symmetric windings of transformer.

## 3.2 Schematic

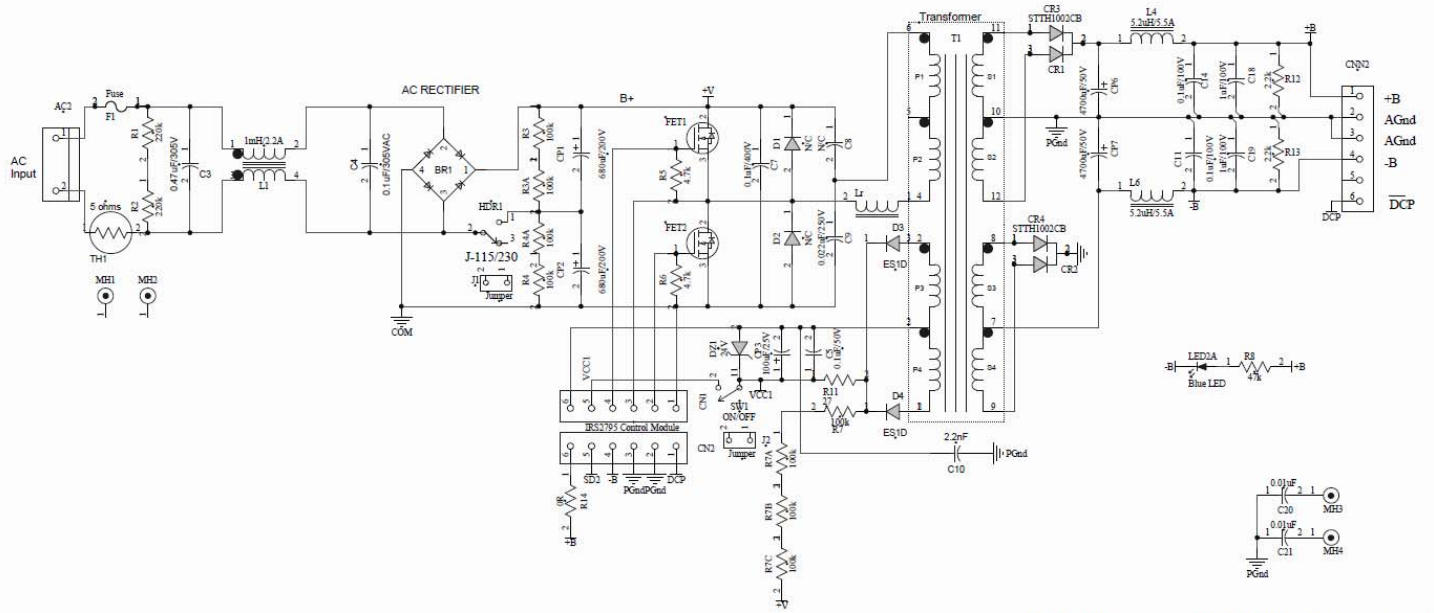

IRAUDPS3, LLC SMPS 200W, Mother Board

Figure 1 – Main Board Schematic

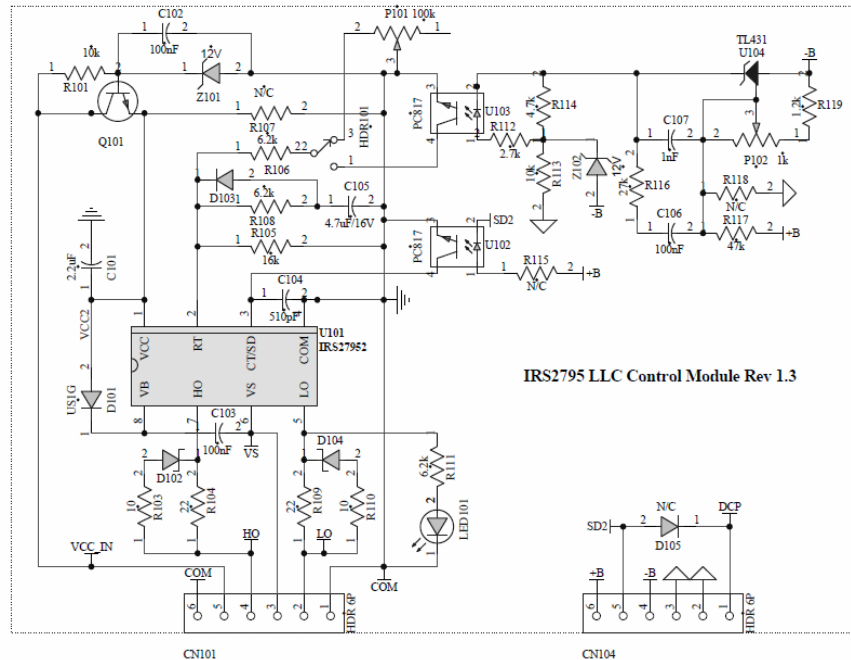

Figure 2 – Control Board Schematic

### 3.3 Board PCB Layout

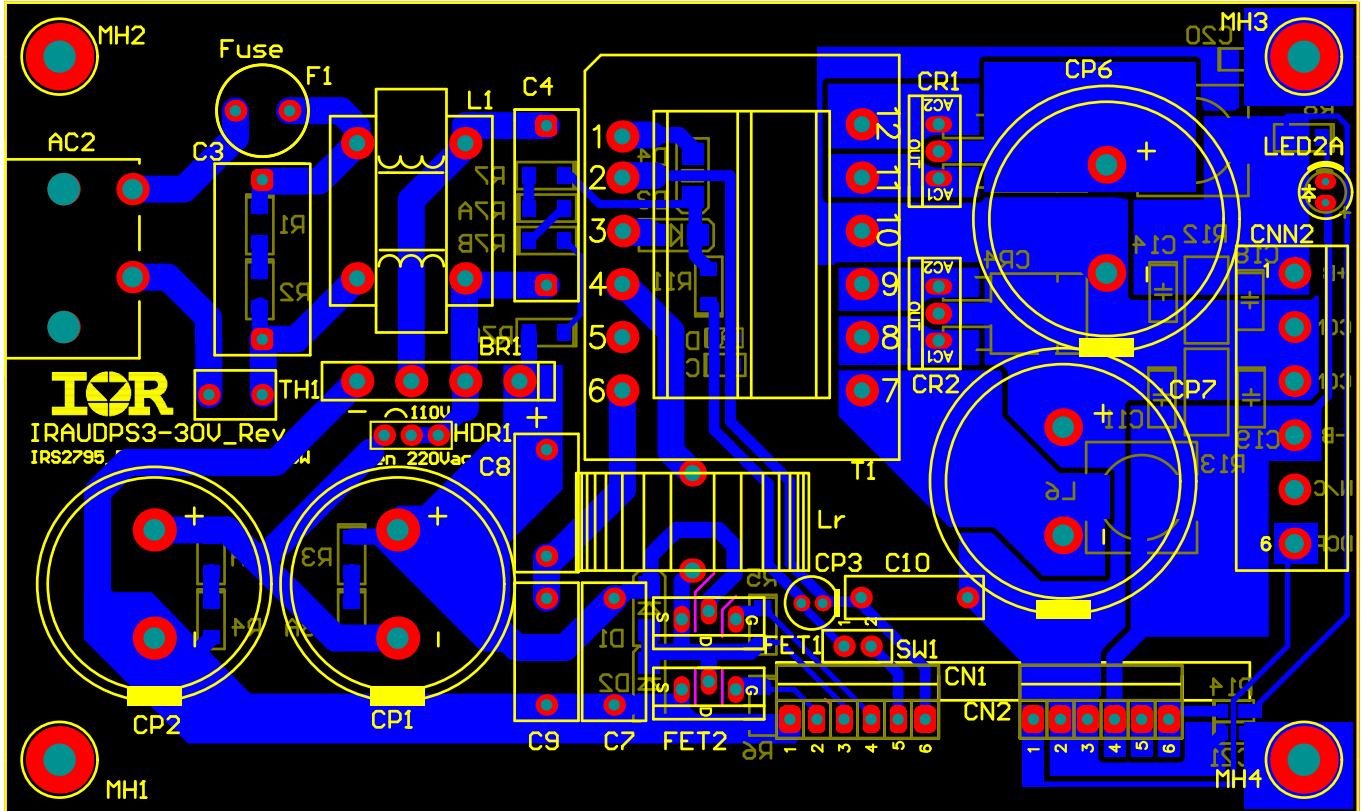

Figure 3 – Main Board Layout (Single layer PCB)

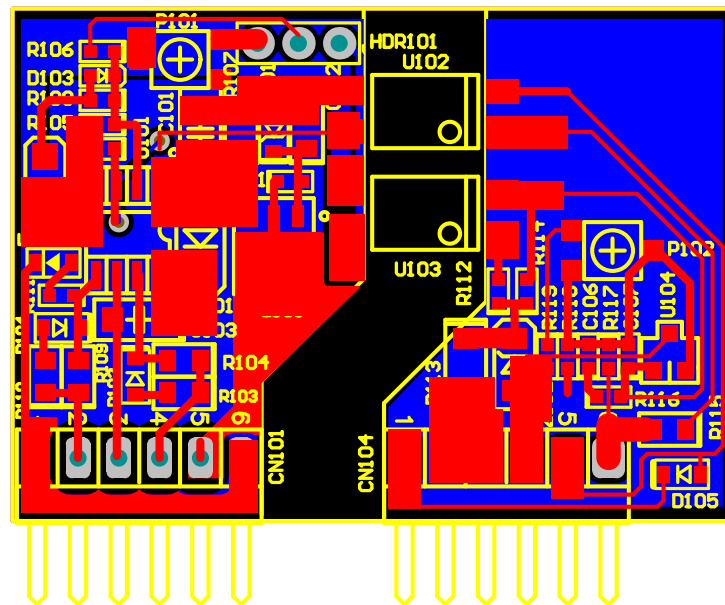

Figure 4 – Control Board Layout (double layer PCB)

### 3.4 Bill of Materials

Qty.	Value	Description	Designator	Digikey P/N	Vendor
3	N/C		C8, D1, D2		
2	(open) MUR1620CTG	(OPEN)	CR1, CR2	(open)	ON Semiconductor
1	2P AC Receptacle RA	2P AC Receptacle RA	AC2	Q273-ND	Qualtek
1	0.022uF/250V	CAP .022UF 630V METAL POLYPRO	C9	495-1329-ND	EPCOS Inc
1	0.1uF/50V	CAP .10UF 50V CERAMIC X7R 0805	C5	399-1169-1-ND	Kemet
1	0.1uF/305VAC	CAP .10UF 305VAC EMI SUPPRESSION	C4	495-2319-ND	EPCOS Inc
1	0.1uF/400V	CAP .10UF 400V METAL POLY	C7	495-2444-ND	EPCOS Inc
2	0.1uF/100V	CAP .1UF 100V CER X7R SMT 1206	C11, C14	399-1805-1-ND	Kemet
1	0.47uF/305V	CAP .47UF 305VAC EMI SUPPRESSION	C3	495-2322-ND	EPCOS Inc
1	100uF/25V	CAP 100UF 25V ELECT VZ RADIAL	CP3	493-1301-ND	Nichicon
2	680uF/200V	CAP 680UF 200V ELECT SMQ SNAP	CP1, CP2	565-2733-ND	United Chemi-Con
2	4700uF/50V	CAPACITOR 4700UF 50V ELECT TSUP	CP6, CP7	P6931-ND	Panasonic - ECG
2	1uF/100V	CAP CER 1UF 100V X7R 1206	C18, C19	490-3909-1-ND	Murata Electronics North America
1	2.2nF	CAP CER 2200PF 250VAC X1Y1 RAD	C10	445-2411-ND	TDK
2	0.01uF	CAP CERM .01UF 10% 50V X7R 0805	C20, C21	478-1383-1-ND	AVX Corporation
1	CONN BLOCK TERM PCB 5.08MM 6POS	CONN BLOCK TERM PCB 5.08MM 6POS	CNN2	281-1438-ND	Weidmuller
1	CONN HEADER 2POS .100	CONN HEADER 2POS .100 VERT TIN	SW1	WM6602-ND	Molex Connector Corporation
1	3 pin header o.100" pitch	CONN HEADER 3POS .100 VERT TIN	HDR1	WM6603-ND	Molex Connector Corporation
2	STTH1002CB	DIODE FAST 200V 10A D-PAK	CR3, CR4	497-3536-5-ND	STMicroelectronics
2	ES1D	DIODE ULTRA FAST 1A 200V SMA	D3, D4	ES1D-E3/61TGICT-ND	Vishay/General Semiconductor
1	24V	DIODE ZENER 200MW 24V SOD323	DZ1	MMXZ5252B-TPMSCT-ND	Micro Commercial Co
1	Transformer	019-7340-01R	T1		Precision
1	Mini Fuse 4A	FUSE 4A 250V 8.5X8.5 TIME-LAG	Fuse	486-1474-ND	Schurter Inc
1	Pico fuse holder	FUSEHOLDER FOR SUB-MINI LINK PCB	F1	486-1244-ND	Schurter Inc
2	5.2uH/5.5A	INDUCTOR POWER SHIELD 5.2UH SMD	L4, L6	513-1396-1-ND	Cooper Bussmann, Copper Bussmann
1	Jumper	Jumper	Lr		
2	IRS2795 Control Module	IRS2795 Control Module	CN1, CN2	IRS2795	IR-XIAN, IR_XIAN
1	Blue LED	LED 470NM ROUND BLUE 3MM	LED2A	LED 470NM ROUND BLUE 3MM	TT Electronics
1	1mH/2.2A	LINE FILTER 1.0MH 2.2A N SERIES	L1	PLK1076-ND	Panasonic - ECG
4	Screw M3	MH-130	MH1, MH2, MH3, MH4		
2	IPA50R250CP or FDPF18N50	MOSFET N-CH 550V 13A TO-220F or MOSFET N-CH 500V 18A TO-220F	FET1, FET2	IPA50R250CP -ND FDPF18N50T-ND	Infineon / Fairchild



1	GBU4J-BP	RECT BRIDGE GPP 4A 600V GBU0	BR1	GBU4J-BPMS-ND	Micro Commercial Co
1	0R	RES 0 OHM 1/8W 0805 SMD	R14	RHM0.0ARCT-ND	Rohm Semiconductor
2	2.2k	RES 2.2K OHM 1W 5% 2512 SMD	R12, R13	PT2.2KXCT-ND	Panasonic - ECG
2	4.7k	RES 4.7K OHM 1/4W 5% 1206 SMD	R5, R6	RHM4.7KERCT-ND	Rohm Semiconductor
1	27	RES 27 OHM 1/4W 5% 1206 SMD	R11	311-27ERCT-ND	Yageo
1	47k	RES 47K OHM 1/4W 5% 1206 SMD	R8	RHM47KERCT-ND	Rohm
8	100k	RES 100K OHM 1/4W 5% 1206 SMD	R3, R3A, R4, R4A, R7, R7A, R7B, R7C	RHM100KERCT-ND	Rohm Semiconductor
2	220k	RES 220K OHM 1/4W 5% 1206 SMD	R1, R2	311-220KERCT-ND	Yageo
2	Shorting Jumper	Shorting Jumper 2P_HDR_100	J1, J2	WM23944-ND	Molex Connector Corporation
1	5 ohms	TINRUSH CURRNT LMTR 5.0 OHM RADIAL	TH1	495-2096-ND	EPCOS Inc

### BOM of Main Board

Qty.	Value	Description	Designator	Digikey P/N	Vendor
1	2.2uF	CAP CER 2.2UF 50V X7R 1206	C101	490-3367-1-ND	Murata Electronics North America
1	100nF	CAP .10UF 50V CERAMIC X7R 0805	C102	399-1169-1-ND	Kemet
1	100nF	CAP .10UF 50V CERAMIC X7R 1206	C103	399-1248-1-ND	Kemet
1	510pF	CAP CER 510PF 50V 5% C0G 0603	C104	490-1444-1-ND	Kemet
1	4.7uF/16V	CAP TANTALUM 4.7UF 16V 20% SMD	C105	495-2233-1-ND	Kemet
1	100nF	CAP CER .1UF 50V 10% X7R 0603	C106	490-1519-1-ND	Murata Electronics North America
1	1nF	CAP 1000PF 50V CERAMICX7R 0603	C107	399-1082-1-ND	Kemet
2	HDR 6P	CONN HEADER 6POS .100 R/A TIN	CN101, CN104	WM6006-ND	Molex Connector Corporation
1	US1G	DIODE ULTRA FAST 1A 400V SMA	D101	US1G-E3/61TGICT-ND	Vishay/General Semiconductor
2	SDM100K30L-7	DIODE SCHOTTKY 30V 1.0A SOD323	D102, D104	SDM100K30LDICT-ND	Diodes Inc
1	1N4148WT-7	DIODE SWITCH 100V 150MW SOD-523	D103	1N4148WTDICT-ND	Diodes Inc
1	N/C		D105		
1	3 pin header o.100" pitch	CONN HEADER 3POS .100 VERT TIN	HDR101	WM6603-ND	Molex Connector Corporation
1	Blue	LED 468NM BLUE CLEAR 0805 SMD	LED101	160-1645-1-ND	Lite-On Inc
1	100k	POT 1.0K OHM 3MM CERM SQ TOP SMD	P101	ST32ETB104CT-ND	Copal Electronics Inc
1	1k	POT 1.0K OHM 3MM CERM SQ TOP SMD	P102	ST32ETB102CT-ND	Copal Electronics Inc
1	PBSS4350X	TRANS NPN 50V 3A SOT89	Q101	568-4159-1-ND	NXP Semiconductors
1	10k	RES 10K OHM 1/10W 5% 0603 SMD	R101	311-10KGRCT-ND	Yageo
2	10	RES 10 OHM 1/8W 5% 0805 SMD	R103, R110	P10ACT-ND	Panasonic - ECG
2	22	RES 22 OHM 1/8W 5% 0805 SMD	R104, R109	P22ACT-ND	Panasonic - ECG
1	16k	RES 16.0K OHM 1/10W 1% 0603 SMD	R105	P16.0KHCT-ND	Panasonic ECG

3	6.2k	RES 6.20K OHM 1/10W 1% 0603 SMD	R106, R108, R111	P6.20KHCT-ND	Panasonic ECG
3	N/C		R107, R115, R118		
1	2.7k	RES 2.7K OHM 1/10W 5% 0603 SMD	R112	311-2.7KGRCT-ND	Yageo
1	10k	RES 10K OHM 1/4W 5% 1206 SMD	R113	RHM10KERCT-ND	Rohm Semiconductor
1	4.7k	RES 4.7K OHM 1/10W 5% 0603 SMD	R114	311-4.7KGRCT-ND	Yageo
1	27k	RES 27.0K OHM 1/10W 1% 0603 SMD	R116	311-27.0KHRCT-ND	Yageo
1	47k	RES 47.0K OHM 1/10W 1% 0603 SMD	R117	311-47.0KHRCT-ND	Yageo
1	1.2k	RES 1.20K OHM 1/10W 1% 0603 SMD	R119	311-1.20KHRCT-ND	Yageo
1	IRS27952	IC DRIVER HALF BRIDGE OSC 8SOIC	U101	IRS27952SPBF-ND	International Rectifier (Infineon Technologies)
2	PC817	PHOTOCOUPLER LO IF TRAN 4-SMD	U102, U103	425-1461-1-ND	Sharp Microelectronics
1	TL431	IC PREC SHUNT REG ADJ SOT23-3	U104	568-4883-1-ND	NXP Semiconductor
1	12V	DIODE ZENER 200MW 12V SOD323	Z101	MM3Z12VT1GOSCT-ND	ON Semiconductor
1	12V	DIODE ZENER 500MW 12V SOD123	Z102	BZT52C12-FDICT-ND	Diodes Inc

### BOM of the Control Board

## 4 EVALUATION BOARD OPERATING PROCEDURE

**CAUTION: Potentially lethal voltages exist on this demo board when powered up. Improper or unsafe handling of this board may result in serious injury or death.**

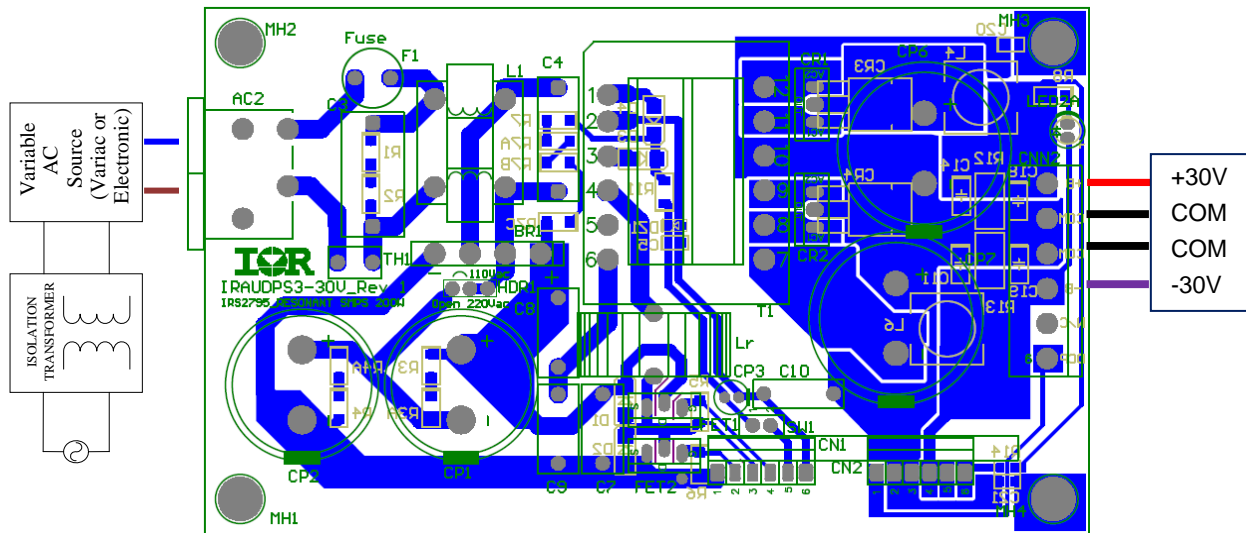

Figure 5 - Recommended Evaluation Board Test Setup

## 4.1 Load Connection

Connect electronic loads or class-D audio amplifier board (such as IRAUDAMP5) to connector CNN2. +30V is marked as +B on the board, and -30V is marked as -B.

## 4.2 AC Input

The PSU is designed to work under narrow AC input range. On the main board there is a jumper to select AC line voltage. If the jumper is shorted, the board works at 110Vac +/-20%. If the jumper is open, the board works at 220Vac +/-20%.

The AC voltage select jumper HDR1 locates between the input bridge rectifier BR1 and Bus capacitor C8. The default connection is for 110V AC input (HDR1 jumper is shorted).

An isolation transformer on the AC side is highly recommended, so that all the control signals on the board can easily be probed by using regular scope probes.

The NTC resistor limits the inrush current upon initial application of full AC line voltage. Once power is applied to demo board, potentially lethal high voltages will be present on board and necessary precautions should be taken to avoid serious injury.

## 4.3 IRS27952 DC Supply Voltage

The board is self-supplied by startup circuit and auxiliary winding of transformer. The startup circuit starts to work once AC or DC input voltage applies to the board.

## 4.4 Disconnect the Board

It is recommended to discharge the bulk capacitor CP1 and CP2 every time after evaluation is finished:

- Disconnect the high voltage AC source from AC2
- Apply an external 12V DC voltage to control board for a while until bus voltage drops to 0V. Connect 12V to Vcc (pin 5 of CN1) and COM to pin 1 of CN1.

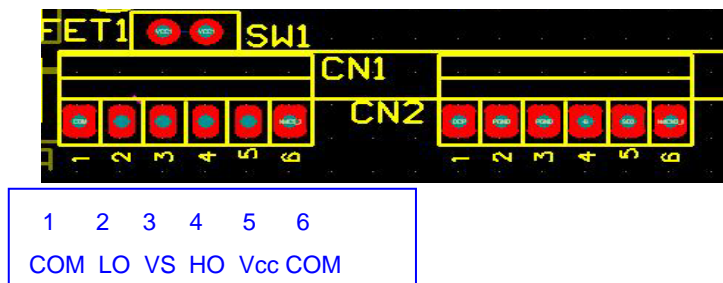

# 5 SYSTEM PERFORMANCE CHARACTERIZATION

## 5.1 Primary Waveforms

Test Conditions: Full Load (2A to +B and -B); No Load (0A)

Ch 1: Low-side device  $V_{GS}$  – Ch3: Voltage at VS pin

Ch 4: Resonant tank current

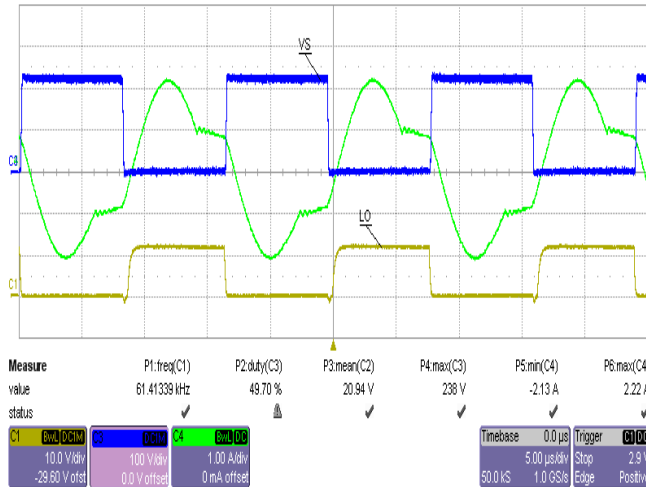

88Vac Input, Full Load Operation

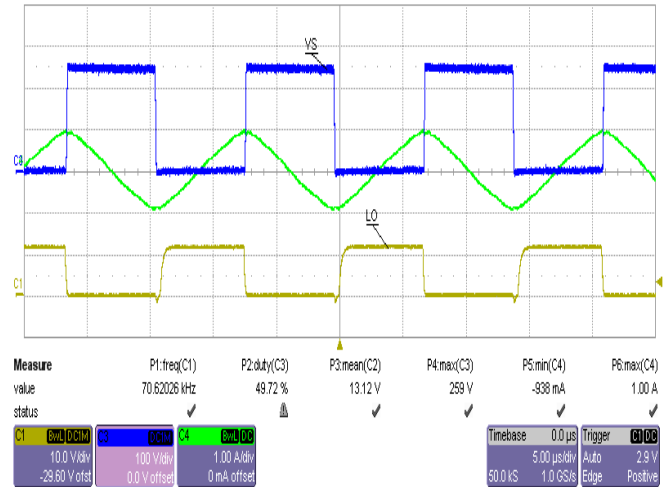

88Vac Input, No Load Operation

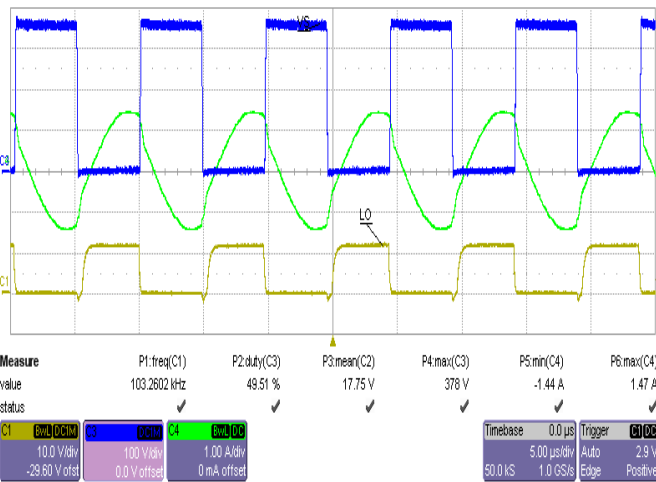

132Vac input, Full Load Operation

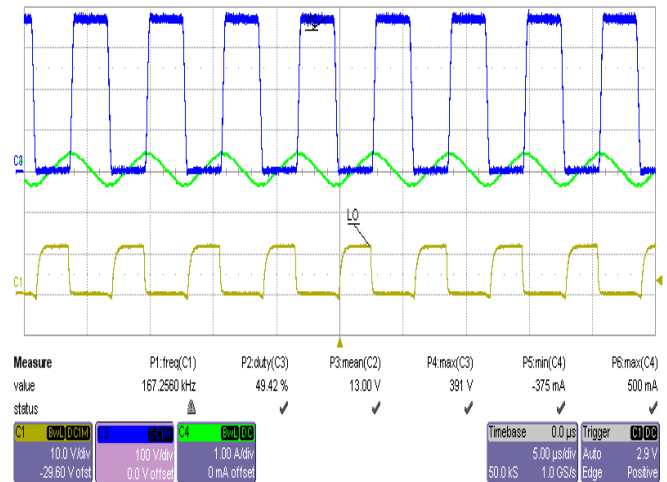

132Vac Input, No Load Operation

**Ch 2: +30V Output Voltage** **Ch 4: Resonant tank current**

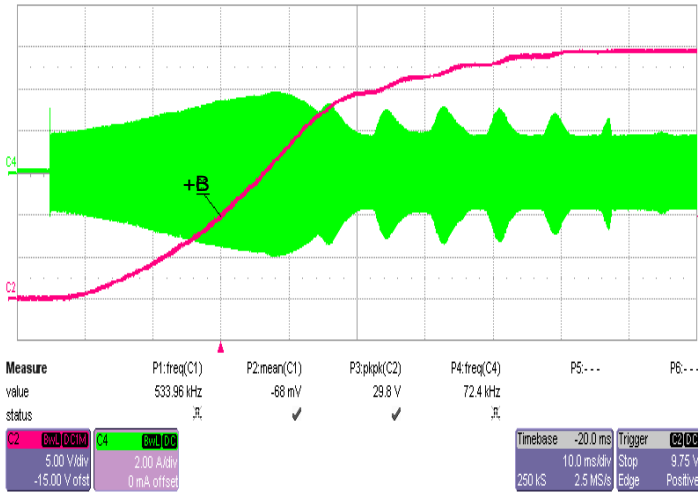

110Vac, 120W load startup

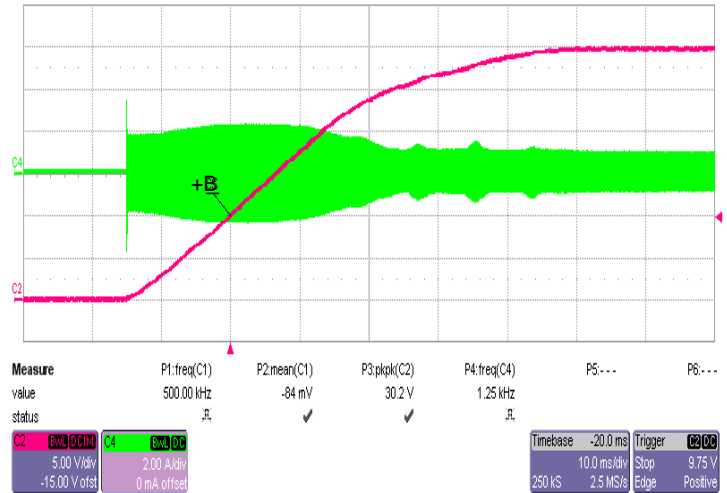

110Vac, no load startup

The switching frequency sweeps from 180kHz to regulation frequency in 20ms~30ms, prevents high current spike during startup. The output voltage has no overshoot during startup.

## 5.2 Dynamic Load Response and Regulation Waveforms

Test Conditions: Peak Load (8A to +B and -B); No Load (0A)

**Ch 1: +B output** – **Ch 2: -B output**

**Ch 4: Output current**

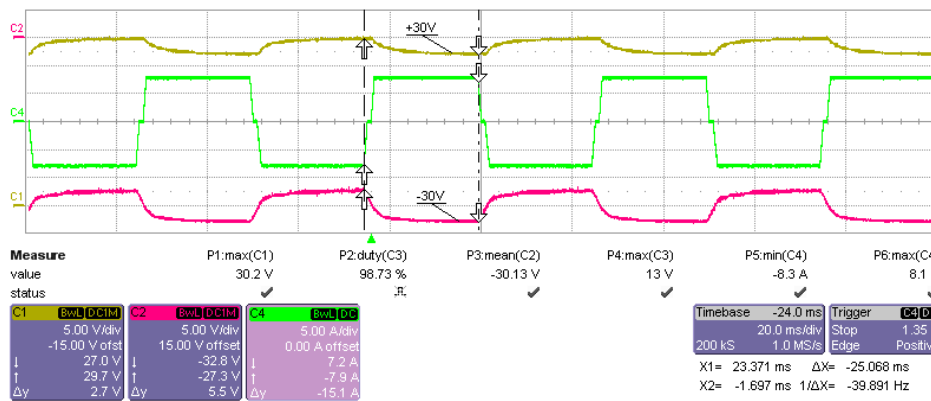

110Vac, 8A dynamic load to each rail  
8A peak current, 20Hz, 50% duty-cycle

## 5.3 Output Waveforms with Audio Amplifier Load

### 5.3.1. 110Vac input, 1kHz, 10% clipping

Ch1: +B, Ch2: -B, Ch3: output current on the GND return

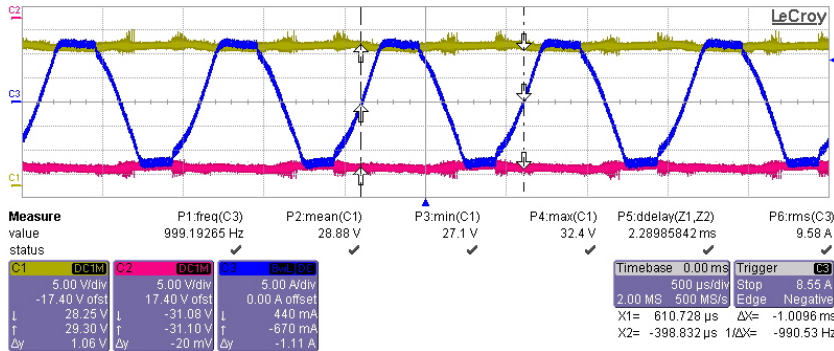

Output voltage regulated at +29V/-31V. Power supply output power 250W.

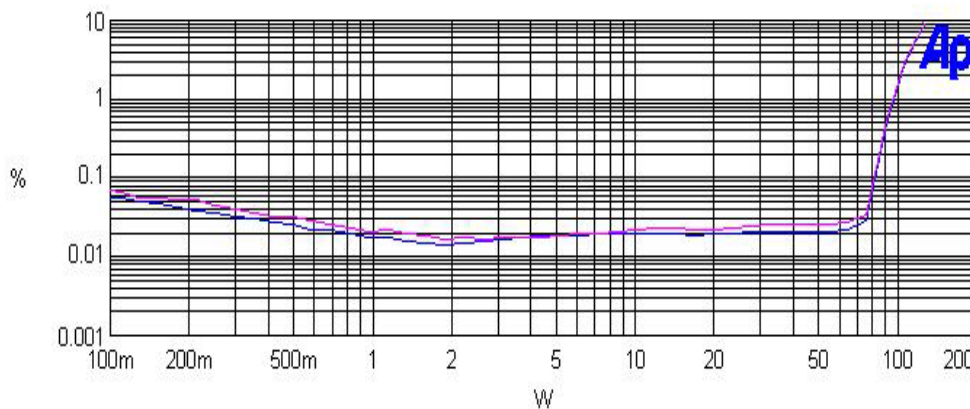

Sweep	Trace	Color	Line Style	Thick	Data	Axis	Comment
1	1	Blue	Solid	1	Anlr.THd+N Ratio	Left	
1	3	Magenta	Solid	1	Anlr.THd+N Ratio	Left	

Amp12 THD vs Pwr\_1kHz\_stereo\_rev2.at27

Output power 125W/ch at 1kHz, 10% clipping.

### 5.3.2 110Vac input, 20Hz, 10% clipping

Ch1: +B, Ch2: -B, Ch3: output current on the GND return

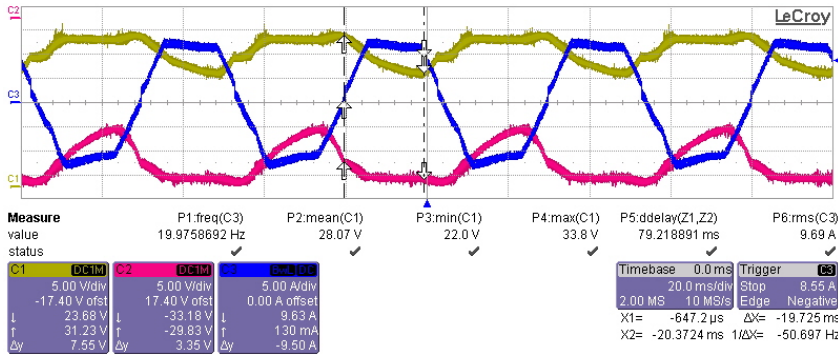

At 20hz, 10% clipping, +B varies from 31.2V to 23.7V, ripple 7.5V; -B varies from -32.2V to -23.2V, ripple 9V. Power supply output power 200W.

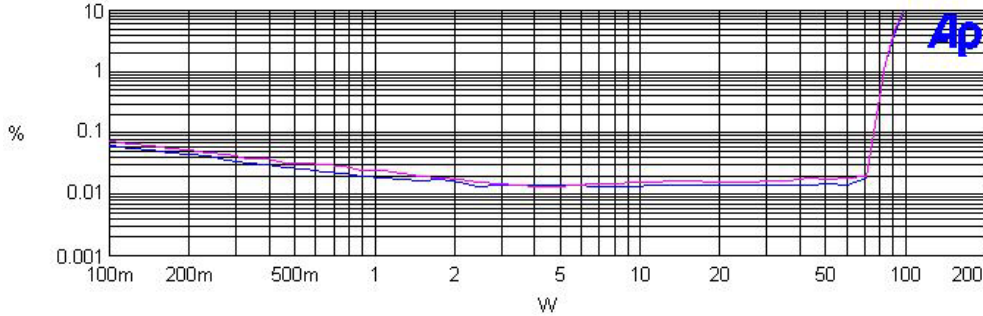

Sweep	Trace	Color	Line Style	Thick	Data	Axis	Comment
1	1	Blue	Solid	1	Anlr.THd+N Ratio	Left	
1	3	Magenta	Solid	1	Anlr.THd+N Ratio	Left	

THD, Liz

Amp12 THD vs Pwr\_20Hz\_stereo\_in phase\_110V.at27

Output power 100W/ch at 20hz, 10% clipping.

### 5.3.3 132Vac input, 20Hz, 10% clipping

Ch1: +B, Ch2: -B, Ch3: output current on the GND return

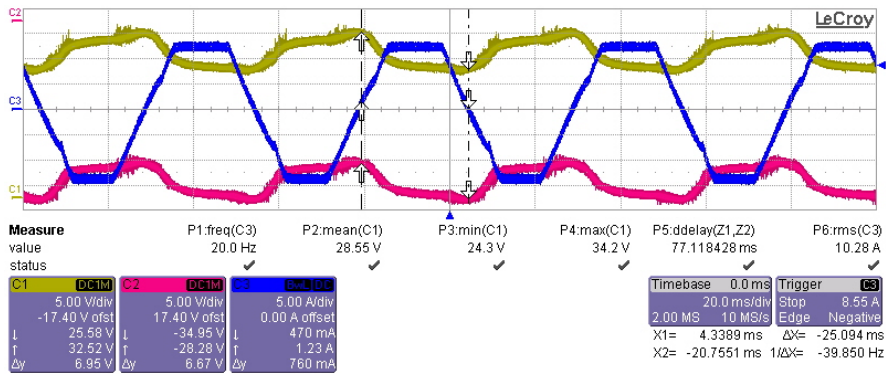

At 20hz, 10% clipping, +B varies from 32.5V to 25.6V, ripple 6.9V; -B varies from -34.9V to -28.3V, ripple 6.6V. Power supply output power is 220W.

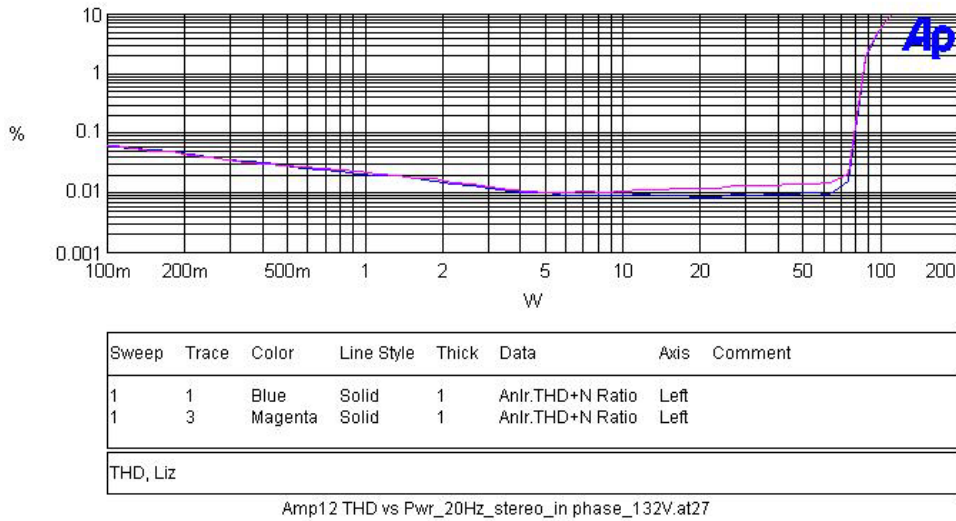

Output power 110W/ch at 20hz, 10% clipping.



### 5.3.4 88Vac input, 20Hz, 10% clipping

Ch1: +B, Ch2: -B, Ch3: output current on the GND return

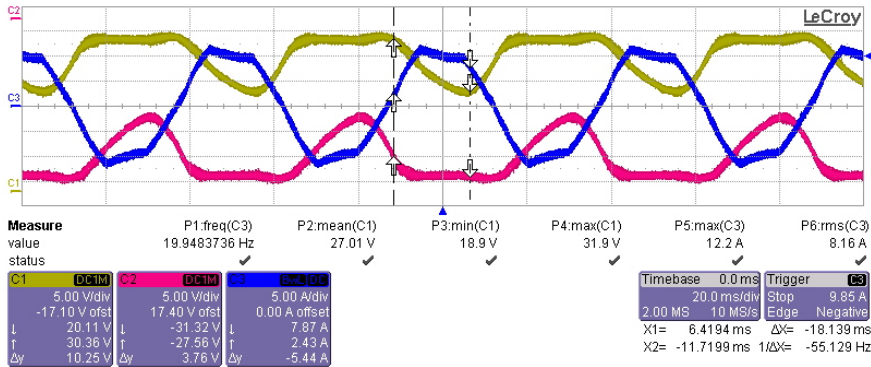

At 20hz, 10% clipping, +B varies from 30.4V to 20.11V, ripple 10.3V; -B varies from -31.1 V to -19.5V, ripple 11.6V. Power supply output power is 150W.

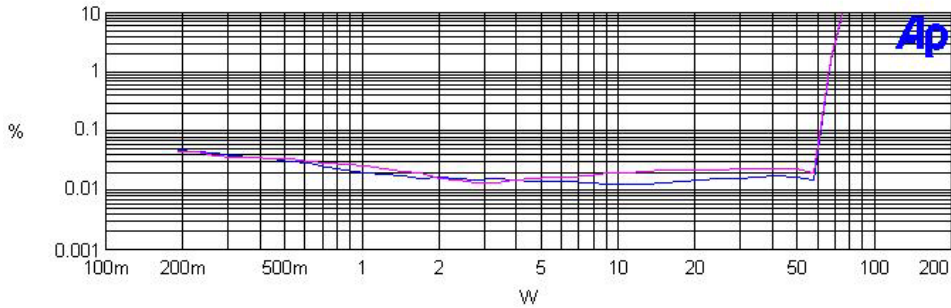

Sweep	Trace	Color	Line Style	Thick	Data	Axis	Comment
1	1	Blue	Solid	1	Anlr.THd+N Ratio	Left	
1	3	Magenta	Solid	1	Anlr.THd+N Ratio	Left	

THD, Liz

Amp12 THD vs Pwr\_20Hz\_stereo\_in phase\_88V.at27

Output power 75W/ch at 20hz, 10% clipping.

## 5.4 Output Ripple

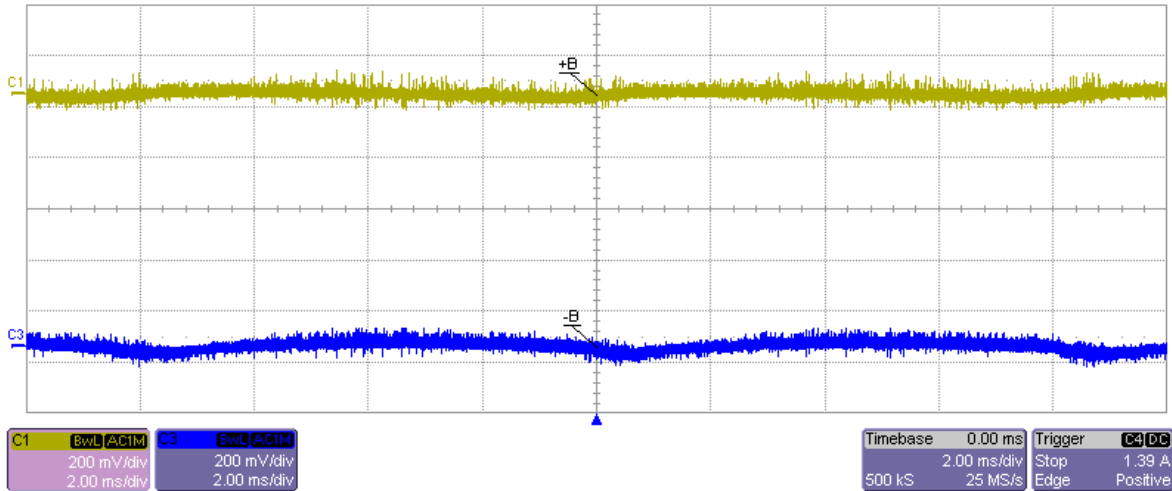

Both +B and -B output voltage ripple is less than 100mV at 2A load.

## 5.5 Efficiency

The efficiency was tested with constant load. The result is shown in the table below.

Low line:

Vinac(V)	Iout(A)	+B	Iout(A)	-B	Pin (W)	Pout (W)	Efficiency
88	0	29.93	0	29.99	2.5	0	0
	2	29.11	0	30.81	65.7	58.22	88.6%
	0	30.37	2	29.55	66.4	59.1	89.0%
	2	29.38	2	30.53	134.6	119.82	89.0%
110	0	29.94	0	30.06	2.51	0	0
	2	29.24	0	30.7	65.1	58.48	89.8%
	0	30.34	2	29.61	65.8	59.22	90.0%
	2	29.55	2	30.4	132.4	119.9	90.6%
132	0	29.96	0	29.99	2.7	0	0
	2	29.16	0	30.8	65.1	58.32	89.6%
	0	30.3	2	29.65	66	59.3	89.8%
	2	29.58	2	30.37	132	119.9	90.8%

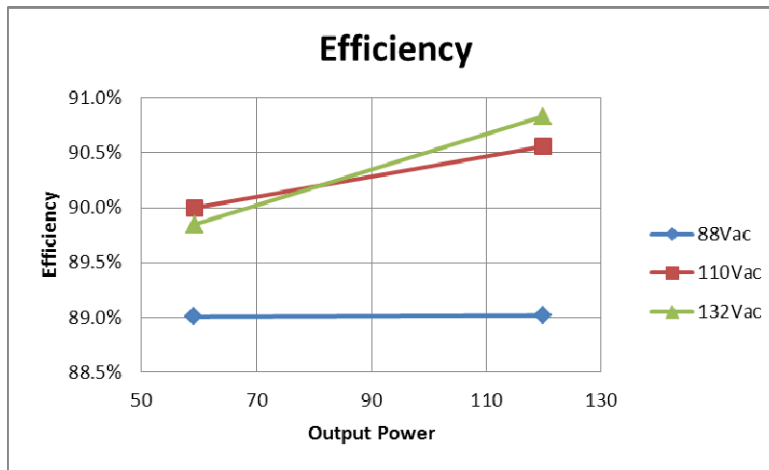

High line:

Vinac(V)	Iout(A)	+B	Iout(A)	-B	Pin (W)	Pout (W)	Efficiency
176	0	29.935	0	30.07	2.3	0	0
	2	29.42	2	30.51	132	119.86	90.8%
220	0	29.96	0	30.06	2.5	0	0
	2	29.56	2	30.39	130	119.9	92.2%
264	0	29.96	0	30.07	2.7	0	0
	2	29.58	2	30.39	130	119.94	92.3%

## 5.6 Thermal Data

The thermal performance is tested at 110Vac input and 120W load for 5 minutes.

Ambient	23
Transformer	67
Bridge	76
FET1	50
FET2	51
IC IRS27952	49
CR3	96
CR4	93
Dummy load R12,R13	71

## 6 Transformer Spec

Minimum operating frequency: 60 kHz

Minimum operating frequency: 200 kHz

Primary inductance: 600  $\mu\text{H} \pm 10\%$  @1 kHz - 0.25V (*Note 1*)

Leakage inductance: 160  $\mu\text{H} \pm 10\%$  @1 kHz - 0.25V (*Note 2*)

*Note: 1 Measured between Pins 4 and 6*

*Note: 2 Measured between Pins 4 and 6 with secondary windings shorted*

### 6.1 Electrical Diagram

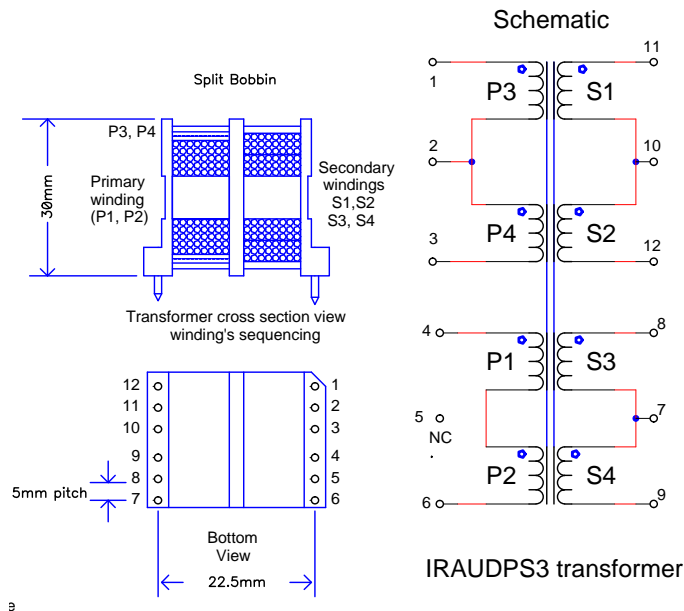

### 6.2 Resonant Transformer Winding Characteristics

Winding	Pins	Turn number	RMS Current
P1&P2	4 - 6	58	1.5A
P3	1 - 2	4	0.1A
P4	2 - 3	4	0.1A
S1	11 - 10	10	1.6A
S2	10 - 12	10	1.6A
S3	8 - 7	10	1.6A
S4	7 - 9	10	1.6A