

Ultrafast Recovery Rectifier

DUR3060CT, 2x 15A, 600V, TO-220AB, Common Cathode

DUR3060CT

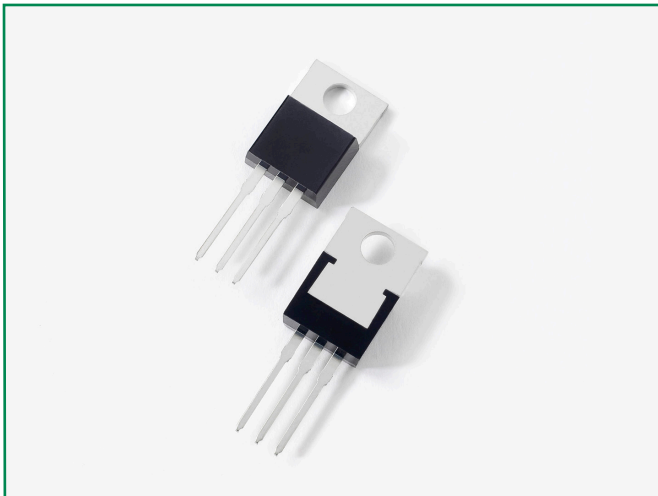

Description

Littelfuse DUR series Ultrafast Recovery Rectifier is designed to meet the general requirements of commercial applications by providing low T_{rr} , high-temperature, low-leakage and low forward voltage drop products. It is suitable for output rectifier, free-wheeling or boost diode in high-frequency power switching application such as switch mode power supply and DC-DC converters.

Features

- Ultra-fast switching
- Low reverse leakage current
- High surge current capability
- Low forward voltage drop
- Common Cathode
- configuration in TO-220AB package
- Pb-free E3 means 2nd level interconnect is Pb-free and the terminal finish material is tin(Sn) (IPC/JEDEC J-STD-609A.01)

Circuit Diagram

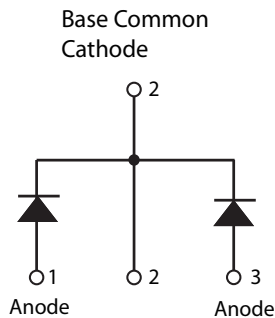

Applications

- Output rectifiers in switch mode power supplies (SMPS) and DC to DC converters
- Free-wheeling diode or boost diode in converters and motor control circuits
- Anti-parallel diode for high frequency switching devices such as IGBT
- Uninterruptible Power Supplies (UPS)
- Inductive heating and melting
- Ultrasonic cleaners and welders

Maximum Ratings

Characteristics	Symbol	Conditions	Max.	Unit
Peak Inverse Voltage	V_{RWM}	-	600	V
Average Forward Current	$I_{F(AV)}$	Rated V_r , @ $T_c = 105^\circ\text{C}$, rectangular wave form	15 (Per Leg)	A
			30 (Total Device)	
Peak One Cycle Non-Repetitive Surge Current (Per Leg)	I_{FSM}	8.3 ms, half sine pulse	110	A

Electrical Characteristics

Characteristics	Symbol	Conditions	Typ.	Max.	Unit
Forward Voltage Drop (Per Leg) ¹	V_{F1}	@15A, Pulse, $T_j = 25^\circ\text{C}$	1.71	2.03	V
	V_{F2}	@15A, Pulse, $T_j = 125^\circ\text{C}$	1.59	-	V
Reverse Current (Per Leg) ¹	I_{R1}	@ $V_R = \text{Rated } V_R$, $T_j = 25^\circ\text{C}$	0.54	100	μA
	I_{R2}	@ $V_R = \text{Rated } V_R$, $T_j = 125^\circ\text{C}$	277	1500	μA
Reverse Recovery Time	t_{rr1}	$I_F = 500\text{mA}$, $I_R = 1\text{A}$, and $I_{rm} = 250\text{mA}$	-	50	ns

Footnote 1: Pulse Width < 300 μs , Duty Cycle <2%

Thermal-Mechanical Specifications

Characteristics	Symbol	Conditions	Specification	Unit
Junction Temperature	T_J	-	-55 to +150	°C
Storage Temperature	T_{stg}	-	-55 to +150	°C
Typical Thermal Resistance Junction to Case	$R_{\theta JC}$	DC operation	1.6	°C/W
Approximate Weight	wt	-	2	g
Case Style	-	TO-220AB	-	-

Figure 1: Typical Forward Characteristics

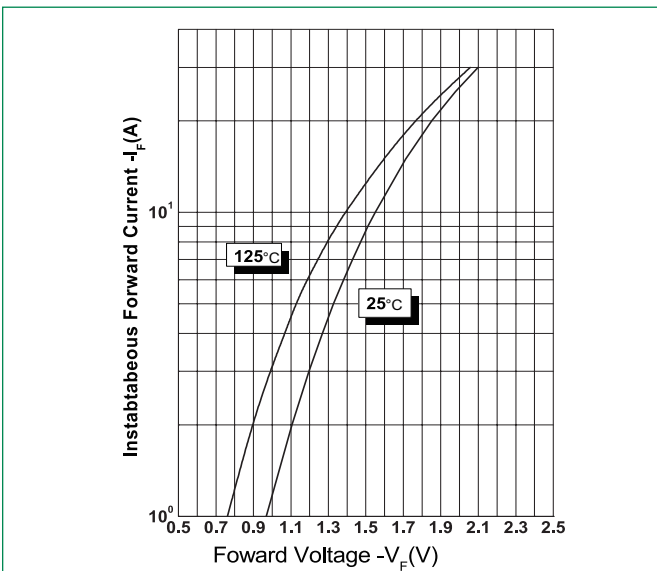

Figure 2: Typical Reverse Characteristics

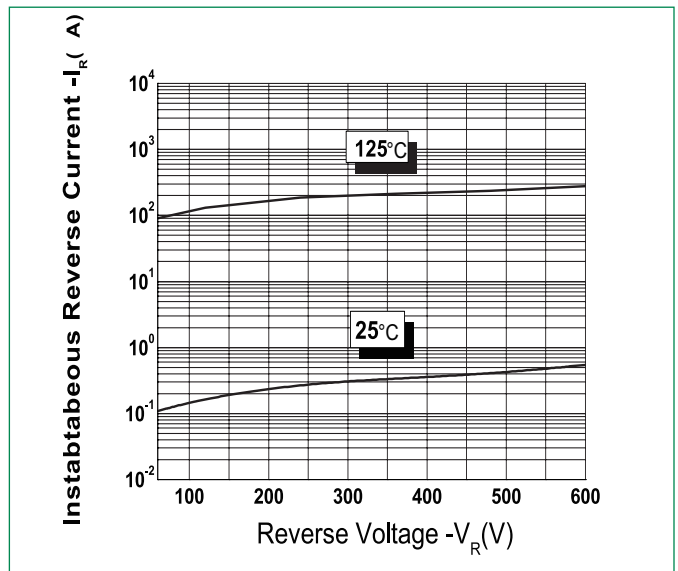
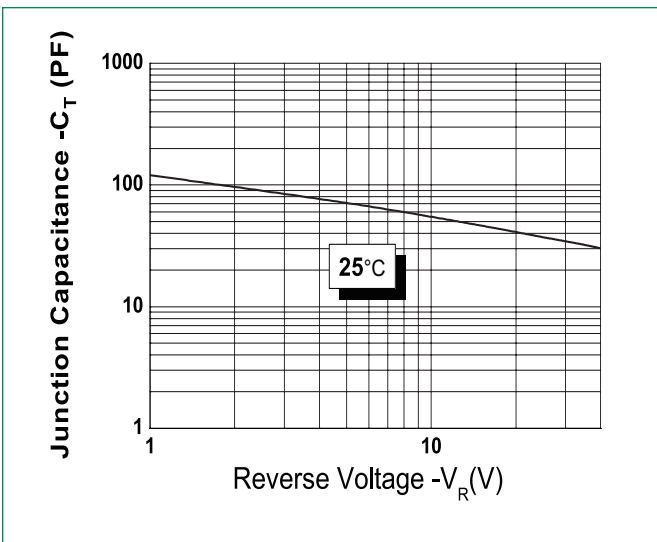
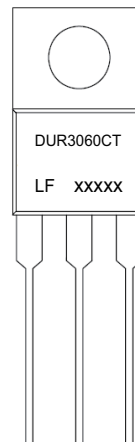

Figure 3: Typical Junction Capacitance



Part Numbering and Marking System



- *xxxxx is YYWWL
- DUR = Device Type
 - 30 = Forward Current (30A)
 - 60 = Reverse Voltage (600V)
 - CT = Configuration
 - LF = Littelfuse
 - YY = Year
 - WW = Week
 - L = Lot Number

Ultrafast Recovery Rectifier

DUR3060CT, 2x 15A, 600V, TO-220AB, Common Cathode

Packing Options

Part Number	Marking	Packing Mode	M.O.Q
DUR3060CT	DUR3060CT	50pcs /Tube	1000

Dimensions-Package TO-220AB

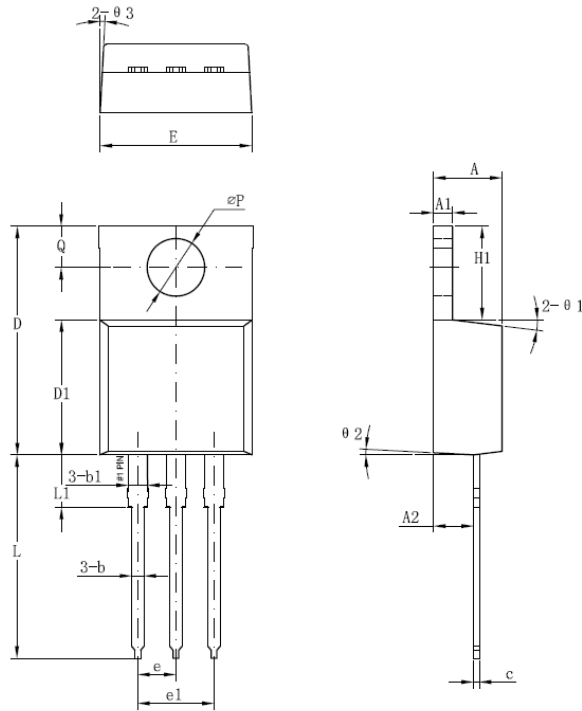

Symbol	Millimeters	
	Min	Max
A	3.56	4.83
A1	0.51	1.40
A2	2.03	2.92
b	0.38	1.02
b1	1.14	1.78
c	0.31*	0.61
D	14.22	16.51
D1	8.38	9.15*
E	9.65	10.67
e	2.54	-
e1	4.98*	-
H1	5.84	6.86
L	12.70	14.73
L1	-	6.35
øP	3.53	4.09
Q	2.54	3.43

Footnote *: The spec. does not comply with JEDEC spec.

Tube Specification TO-220AB

