

PART NUMBER	LENGTH	CUSTOMER PN
10122193-001LF	430±10MM	04050433-004
10122193-002LF	330±10MM	04050433-002
10122193-003LF	230±10MM	04050433-003
10122193-004LF	420±10MM	N.A.
10122193-005LF	320±10MM	N.A.
10122193-006LF	220±10MM	N.A.
10122193-007LF	410±10MM	N.A.
10122193-008LF	310±10MM	N.A.
10122193-009LF	210±10MM	N.A.

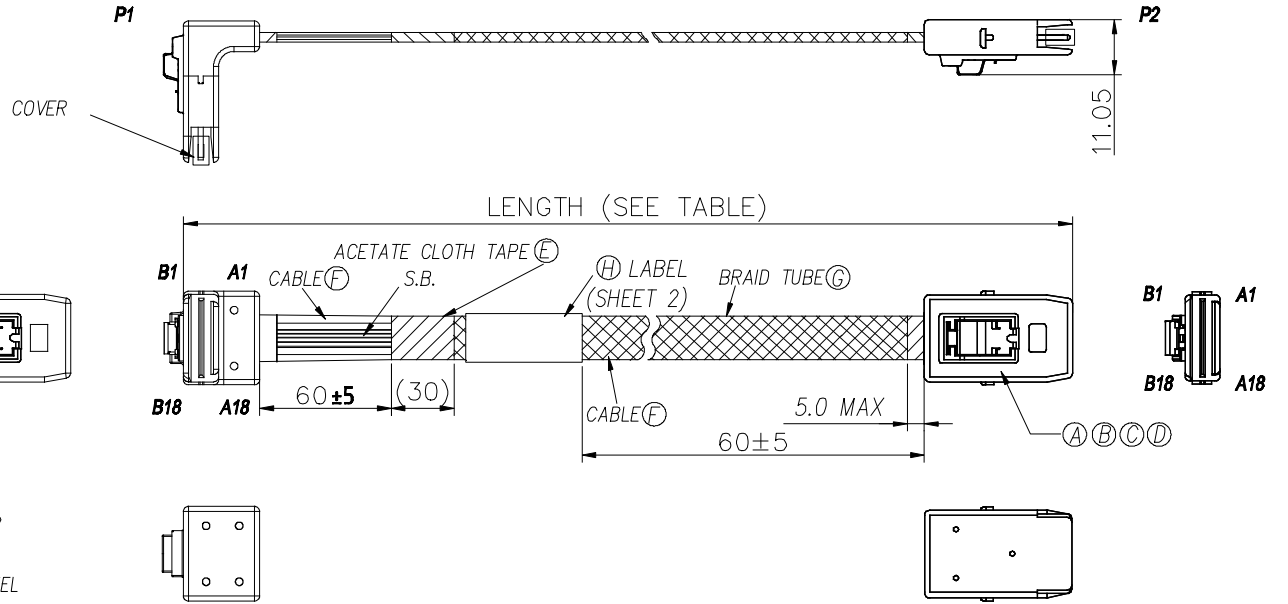

WIRE DIAGRAM

P1	P2	P1	P2
A1	B1	B1	A1
A2	B2	B2	A2
A3	B3	B3	A3
A4	B4	B4	A4
A5	B5	B5	A5
A6	B6	B6	A6
A7	B7	B7	A7
A8	B8	B8	A8
A9	B9	B9	A9
A10	B10	B10	A10
A11	B11	B11	A11
A12	B12	B12	A12
A13	B13	B13	A13
A14	B14	B14	A14
A15	B15	B15	A15
A16	B16	B16	A16
A17	B17	B17	A17
A18	B18	B18	A18

- NOTES
- 1.ROHS COMPLIANCE,EHS CLASSED AS A2
  - 2.GF FINISH FOR THE PADDLECARD  
30U"MIN AU, UNDERPLATING 50U" NICKEL
  - 3.PRODUCT SPECIFICATION REFER TO FCI GS-12-1164
  - 4.SAS PLUG DIMENSION CONFORMS TO SFF-8086 & SFF-8087
  - 5.NO AC COUPLING APPLIED TO BOARD
  - 6.ACETATE CLOTH TAPE WRAPPED AROUND TO THE CABLE EXIST OF EACH PLUG
  - 7.SAS2.1 COMPLIANCE, DATA RATE 6Gbps.
  - 8.LABEL SPECIFICATION SEE SHEET 2.
  - 9.PACKING SPECIFICATION SEE SHEET 3.

ITEM	DESCRIPTION	QUANTITY	UNIT
I	TPC 30AWG,1/0.28, 4X FLAT RIBBON S.B. CABLE	PER LENGTH	M
H	IDENTIFICATION LABEL, SEE SHEET 2	1	PCS
G	EXPANSIBLE BRAID TUBE,BLK	1	PCS
F	8(*1P*30AWG SAS) CABLE	PER LENGTH	M
E	ACETATE CLOTH TAPE,BLK,30MM WIDTH	2	PCS
D	LATCH	2	PCS
C	PBT RESIN,BLK,FOR 36P OVERMOLD	22	G
B	PE RESIN,TRANSPARENT,INNER MOLD	15	G
A	MINISAS36POS PADDLECARD	2	PCS
BILL OF MATERIAL			

mat'l. code		surface	tolerance	projection	product family
		ASME Y14.5	ASME Y14.5		CABLE ASSEMBLY
tolerances unless otherwise specified					
ltr	ecn no	dr	date	MM	title MINISAS36P TO MINISAS36P STR CABLE ASSY
1			070313	[INCH]	
2			011514	scale	
3			022514		
A			031314		sheet 1 of 3
B			052114		size A4
type					INSPECTION Drawing
sheet index	revision sheet	B	B	B	
		1	2	3	

LABEL SPECIFICATION

**CABLE LABEL SPEC.:**

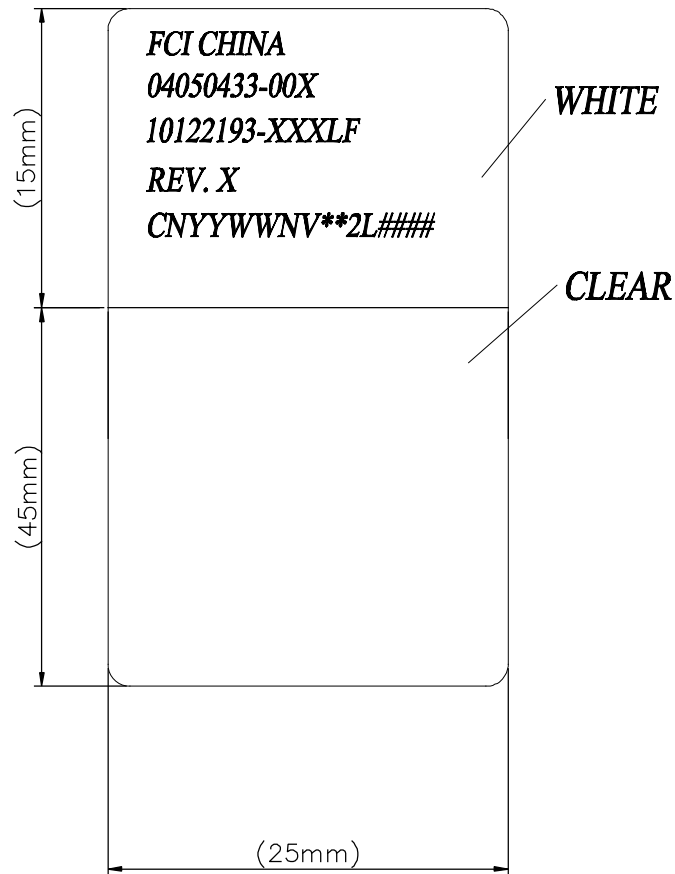

**LABEL NOTES:**

**A. FCI CHINA**

**-THE PRODUCT IS MADE IN FCI CHINA**

**B. CUSTOMER PART NUMBER**

**04050433-00X is customer's P/N. (See sheet 1, P/N list)**

**C. FCI PN and Revision**

**10122193-XXXLF (NOTE: FCI PART NUMBER, SEE SHEET 1 TABLE)**

**Rev. X (DRAWING REVISION, SEE DRAWING FRAME)**

**D. CNYWWNV\*\*2L####**

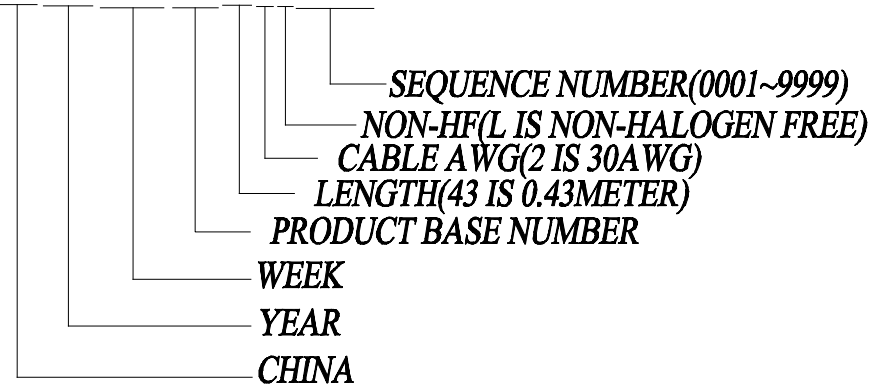

	dwg no	sheet 2 of 3	size
	10122193		A4
	type	CUSTOMER Drawing	

sheet index	revision sheet	B 1	B 2	B 3																
-------------	----------------	-----	-----	-----	--	--	--	--	--	--	--	--	--	--	--	--	--	--	--	--

PACKING SPECIFICATION

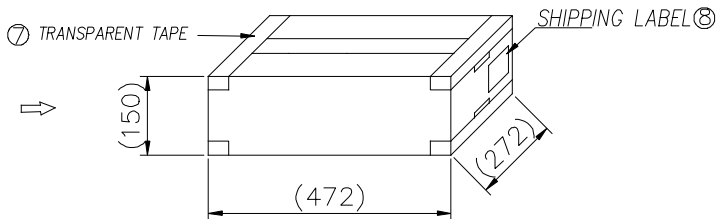
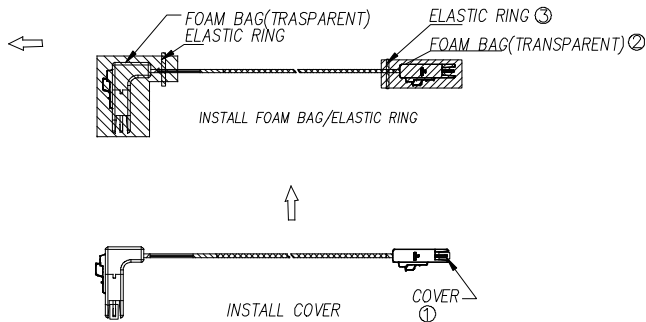
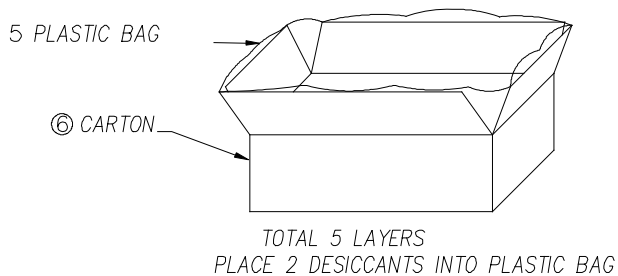
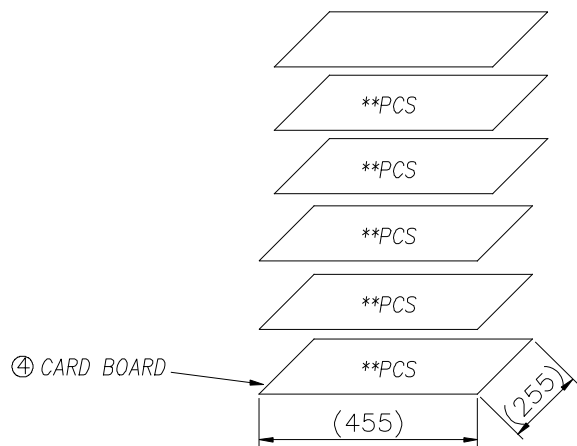

PART NUMBER	PCS/LAYER	PCS/CARTON
10122193-001LF	TBD	TBD
10122193-002LF	TBD	TBD
10122193-003LF	TBD	TBD
10122193-004LF	TBD	TBD
10122193-005LF	TBD	TBD
10122193-006LF	TBD	TBD
10122193-007LF	TBD	TBD
10122193-008LF	TBD	TBD
10122193-009LF	TBD	TBD



dwg no 10122193 sheet 3 of 3 size A4  
type CUSTOMER Drawing

sheet index	revision sheet	B 1	B 2	B 3														