



Parameter	Rating	Units
Relay Load Voltage	350	V
Relay Load Current	120	$\text{mA}_{\text{rms}} / \text{mA}_{\text{DC}}$
Relay On-Resistance (max)	15	Ω
Bridge Rectifier Reverse Voltage	100	V
Darlington Collector Current	120	mA
Darlington Current Gain	10,000	-

Features

- 3750V_{rms} Input/Output Isolation
- FCC Compatible Part 68
- Full-Wave Bridge Rectifier
- Darlington Transistor for Electronic Inductor “Dry” Circuits
- Full Wave Current Detector for Ring Signal or Loop Current Detect
- 2mW Hook Switch Drive Power (Logic Compatible)
- Includes Zener Diodes
- Small 16-Pin SOIC Package (PCMCIA Compatible)
- Board Space and Cost Savings
- No Moving Parts
- JEDEC Standard Pin Out

Applications

- Data/Fax Modem
- Voice Mail Systems
- Telephone Sets
- Computer Telephony Integration
- Set Top Box Modems

Description

This Integrated Telecom Circuit combines a single-pole, normally open (1-Form-A) solid state relay, a bridge rectifier, a Darlington transistor, an optocoupler, and three Zener diodes into one 16-pin SOIC package, consolidating designs and reducing component count in telecom applications.

The ITC137’s optocoupler provides for full-wave detection of ringing signals.

Approvals

- UL Recognized Component: File E76270
- CSA Certified Component: Certificate 1305490
- EN/IEC 60950-1 Certified Component:
TUV Certificate: B 12 11 82667 002

Ordering Information

Part #	Description
ITC137P	16-Pin SOIC (50/Tube)
ITC137PTR	16-Pin SOIC (1000/Reel)

Pin Configuration

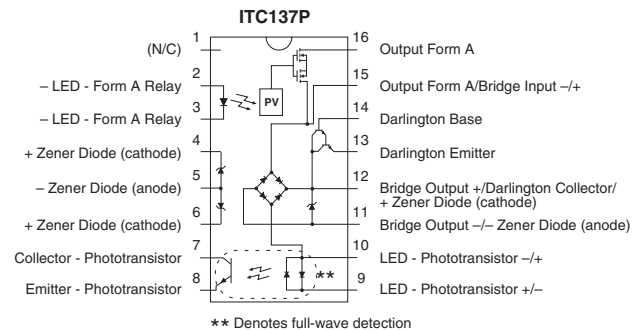

Switching Characteristics of Normally Open Devices

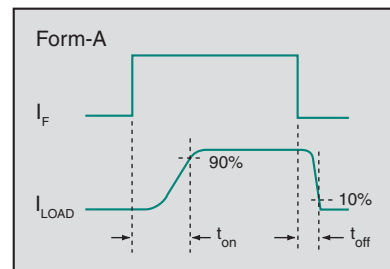

Absolute Maximum Ratings @ 25°C

Parameter	Ratings	Units
Input Control Current, Relay	50	mA
Input Control Current, Detector	100	mA
Total Package Dissipation ¹	1	W
Isolation Voltage, Input to Output	3750	V _{rms}
Operational Temperature	-40 to +85	°C
Storage Temperature	-40 to +125	°C

¹ Derate linearly 8.33 mW / °C

Total Power Dissipation (PD):

$$P_D = P_{\text{HOOKSWITCH}} + P_{\text{BRIDGE}} + P_{\text{DARLINGTON}} + P_{\text{LED}}$$

$$P_D = (R_{DS(on)} I_L^2) + 2(V_F I_L) + (V_{CE} I_L) + (V_{LED} I_F)$$

WHERE:

- R_{DS(on)} = Maximum relay on resistance
- I_L = Maximum loop current
- V_F = Maximum diode forward voltage
- V_{CE} = Maximum voltage collector to emitter
- V_{LED} = Maximum LED forward voltage
- I_F = Maximum LED current

Absolute Maximum Ratings are stress ratings. Stresses in excess of these ratings can cause permanent damage to the device. Functional operation of the device at conditions beyond those indicated in the operational sections of this data sheet is not implied.

Electrical Characteristics @ 25°C

Parameter	Conditions	Symbol	Min	Typ	Max	Units
Output Characteristics						
Blocking Voltage (Peak)	-	V _L	-	-	350	V _P
Load Current						
Continuous	-	I _L	-	-	120	mA _{rms} / mA _{DC}
Peak	t=10ms	I _{LPK}	-	-	400	mA _P
On-Resistance	I _L =120mA	R _{ON}	-	-	15	Ω
Off-State Leakage Current	V _L =350V, T _J =25°C	I _{LEAK}	-	-	1	μA
Switching Speeds						
Turn-On	I _F =5mA, V _L =10V	t _{on}	-	-	3	ms
Turn-Off		t _{off}	-	-	3	ms
Output Capacitance	V _L =50V, f=1MHz	C _{OUT}	-	25	-	pF
Input Characteristics						
Input Control Current to Activate	I _L =120mA	I _F	-	-	5	mA
Input Voltage Drop	I _F =5mA	V _F	0.9	1.2	1.4	V
Reverse Input Voltage	-	V _R	-	-	5	V
Reverse Input Current	V _R =5V	I _R	-	-	10	μA

Electrical Characteristics @25°C: Darlington Transistor Section

Parameter	Conditions	Symbol	Min	Typ	Max	Units
Collector-Emitter Voltage	I _C =10mA _{DC} , I _B =0mA	V _{CEO}	40	-	-	V
Collector Current, Continuous	V _{CE} =3.5V	I _C	-	-	120	mA
Power Dissipation	-	P _D	-	-	500	mW
Off-State Collector-Emitter Leakage Current	V _{CE} =10V, I _B =0mA	I _{CEX}	-	-	1	μA
DC Current Gain	V _{CE} =10V _{DC} , I _C =120mA	h _{FE}	10,000	-	-	-
Saturation Voltage	I _C =120mA	V _{CE(sat)}	-	-	1.5	V
Total Harmonic Distortion	I _C =40mA, f _O =300Hz @ -10dBm	-	-	-	-80	dB

Electrical Characteristics @25°C: Detector Section

Parameter	Conditions	Symbol	Min	Typ	Max	Units
Output Characteristics						
Phototransistor Blocking Voltage	$I_C=10\mu A$	BV_{CEO}	20	50	-	V
Phototransistor Dark Current	$V_{CE}=5V, I_F=0mA$	I_{CEO}	-	50	500	nA
Saturation Voltage	$I_F=16mA, I_C=2mA$	V_{SAT}	-	0.3	0.5	V
Current Transfer Ratio	$I_F=6mA, V_{CE}=0.5V$	CTR	33	400	-	%
Input Characteristics						
Input Control Current	$I_C=2mA, V_{CE}=0.5V$	I_F	-	2	6	mA
Input Voltage Drop	$I_F=5mA$	V_F	0.9	1.2	1.4	V
Input Current (Detector Must be Off)	$I_C=1\mu A, V_{CE}=5V$	I_F	5	25	-	μA

Electrical Characteristics @25°C (Unless Otherwise Noted): Bridge Rectifier Section

Parameter	Conditions	Symbol	Min	Typ	Max	Units
Reverse Voltage	-	V_{RD}	-	-	100	V
Forward Voltage Drop	$I_{FD}=120mA$	V_{FD}	-	-	1.5	V
Reverse Leakage Current	$T_J=25^\circ C, V_R=100V$	I_{RD}	-	-	10	μA
	$T_J=85^\circ C$		-	-	50	
Forward Current	-	I_{FD}	-	-	140	mA
			Peak	$t=10ms$	-	

Electrical Characteristics @25°C: Zener Diodes

Parameter	Conditions	Symbol	Min	Typ	Max	Units
Zener Voltage Between Pins 4&5 and Pins 6&5	$I_{ZT}=20mA$	V_Z	-	4.3	-	V
Zener Voltage Between Pins 12&11	$I_{ZT}=20mA$	V_Z	-	15	-	V
Input to Output Capacitance	-	$C_{I/O}$	-	3	-	pF
Input to Output Isolation	-	$V_{I/O}$	3750	-	-	V_{rms}

EXAMPLE CIRCUIT

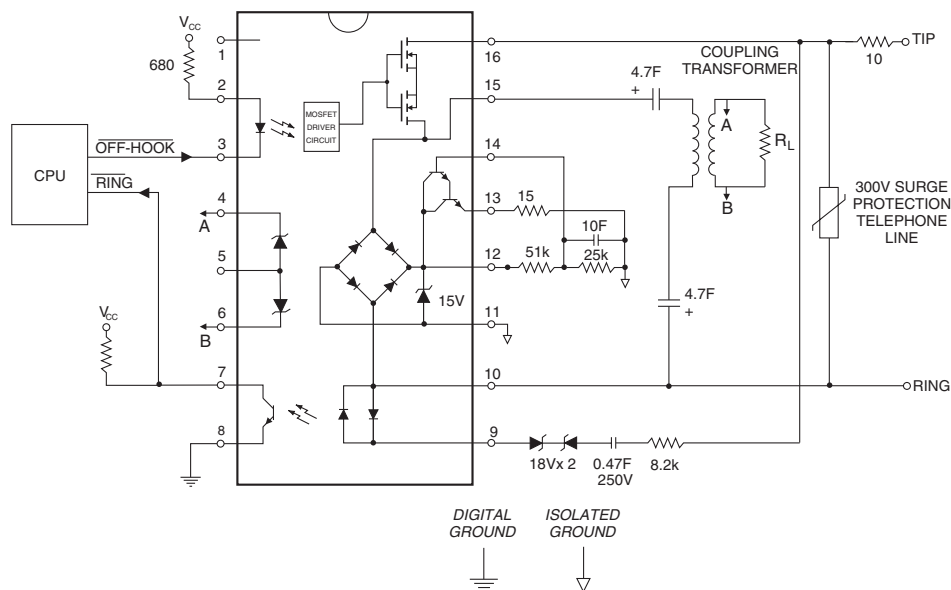

DEVICE PERFORMANCE DATA*

Typical LED Forward Voltage Drop
(N=50, I_F=5mA, T_A=25°C)

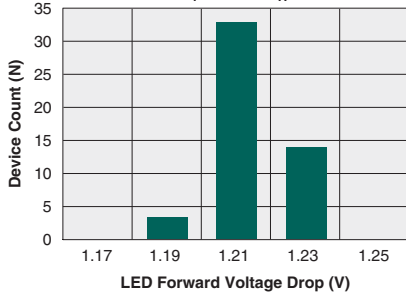

Typical LED Forward Voltage Drop vs. Temperature

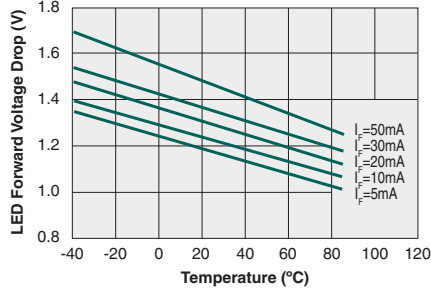

Package Power Derating

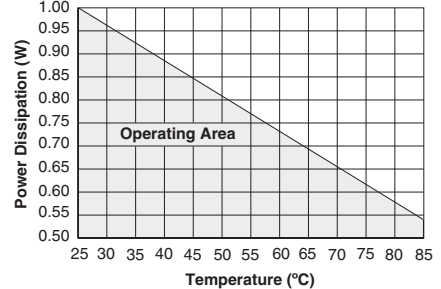

RELAY PERFORMANCE DATA*

Typical Turn-On Time
(N=50, I_F=2mA, I_L=120mA_{DC}, T_A=25°C)

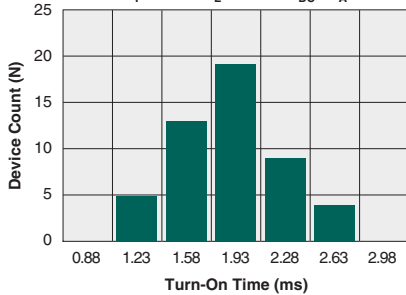

Typical Turn-Off Time
(N=50, I_F=2mA, I_L=120mA_{DC}, T_A=25°C)

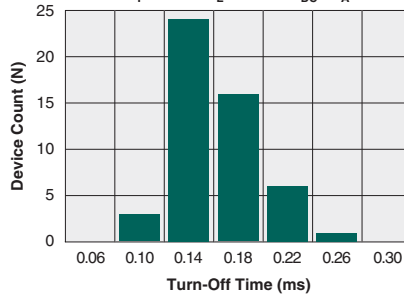

Typical On-Resistance Distribution
(N=50, I_L=120mA_{DC}, T_A=25°C)

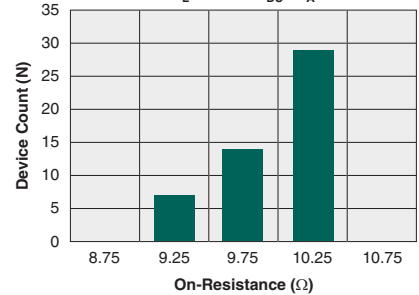

Typical I_F for Switch Operation
(N=50, I_L=120mA_{DC}, T_A=25°C)

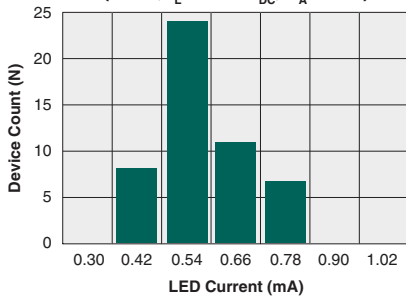

Typical I_F for Switch Dropout
(N=50, I_L=120mA_{DC}, T_A=25°C)

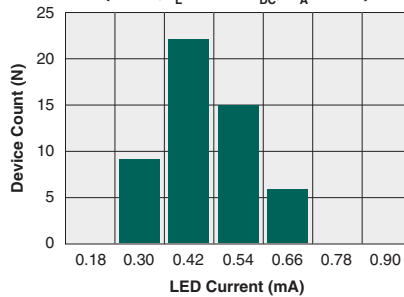

Typical Blocking Voltage Distribution
(N=50, T_A=25°C)

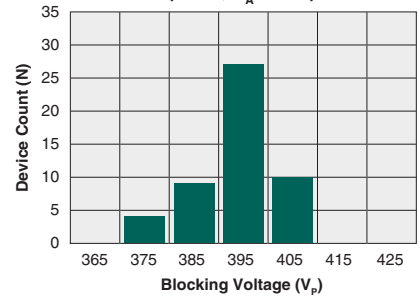

* The Performance data shown in the graphs above is typical of device performance. For guaranteed parameters not indicated in the written specifications, please contact our application department.

RELAY PERFORMANCE DATA (cont)*

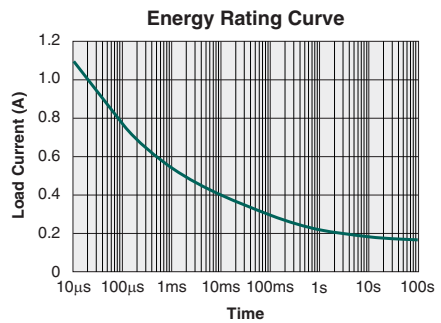
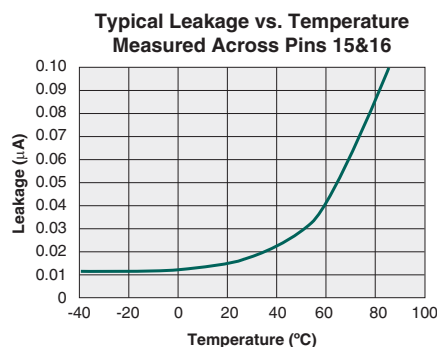
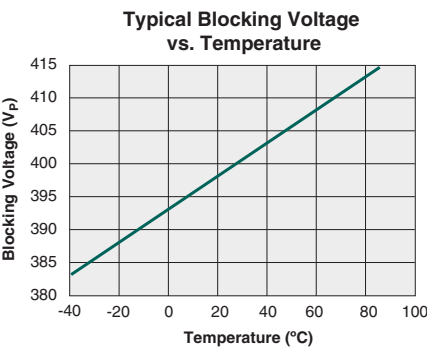
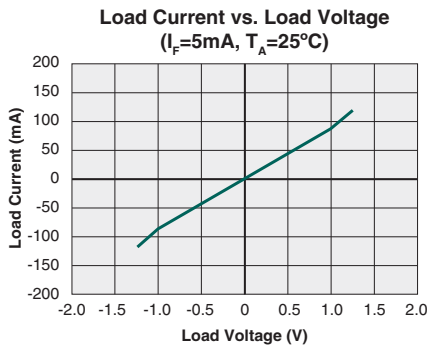
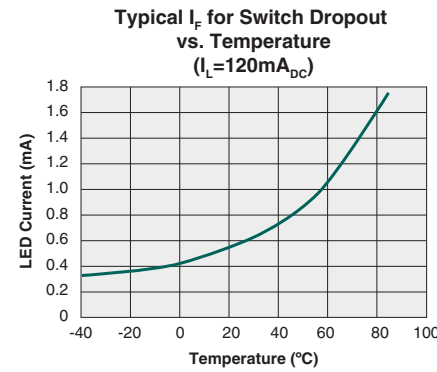
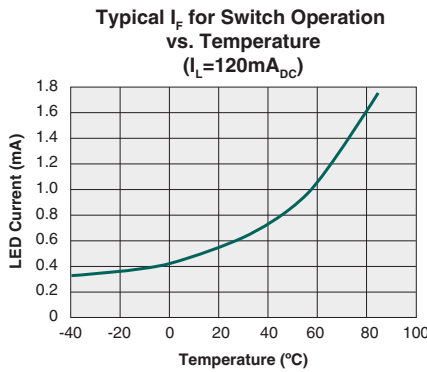
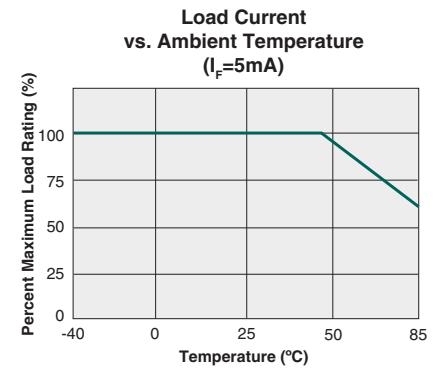
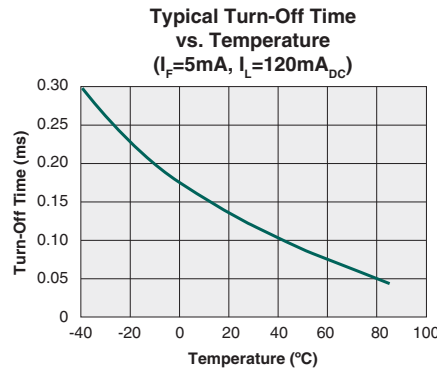
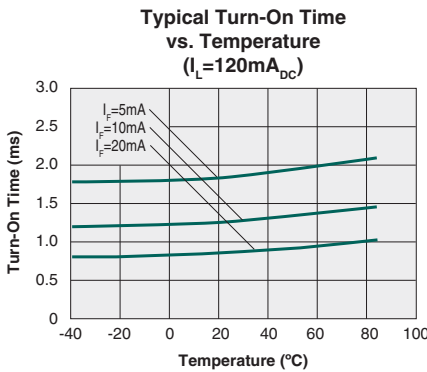
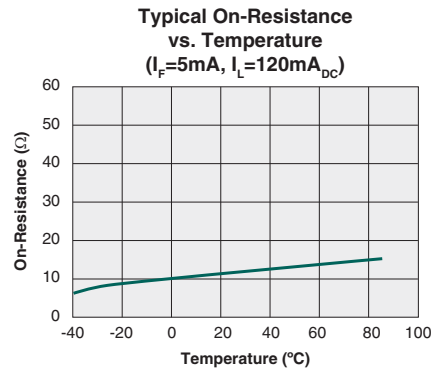
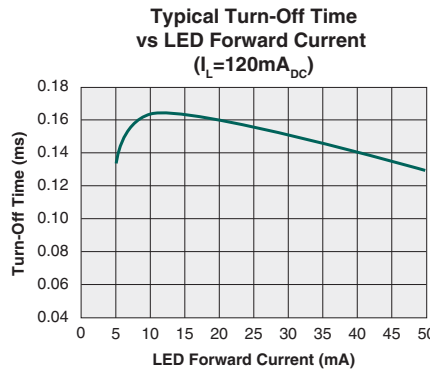
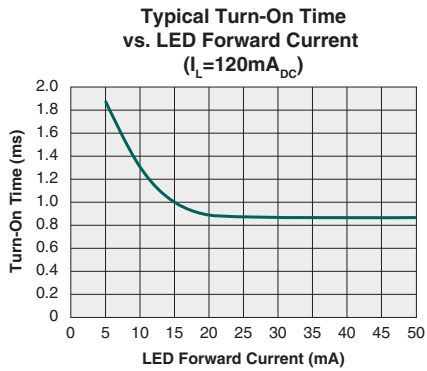

*The Performance data shown in the graphs above is typical of device performance. For guaranteed parameters not indicated in the written specifications, please contact our application department.

PHOTOTRANSISTOR PERFORMANCE DATA*

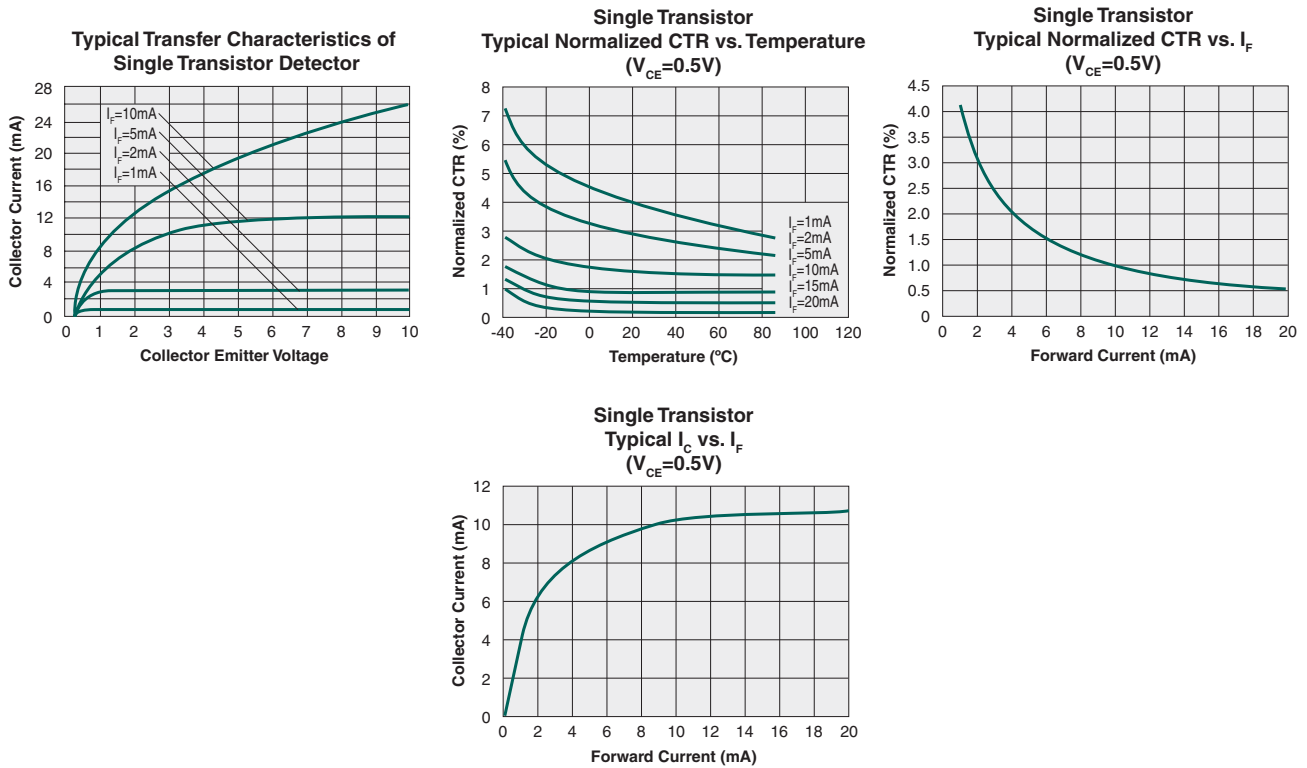

DARLINGTON PERFORMANCE DATA*

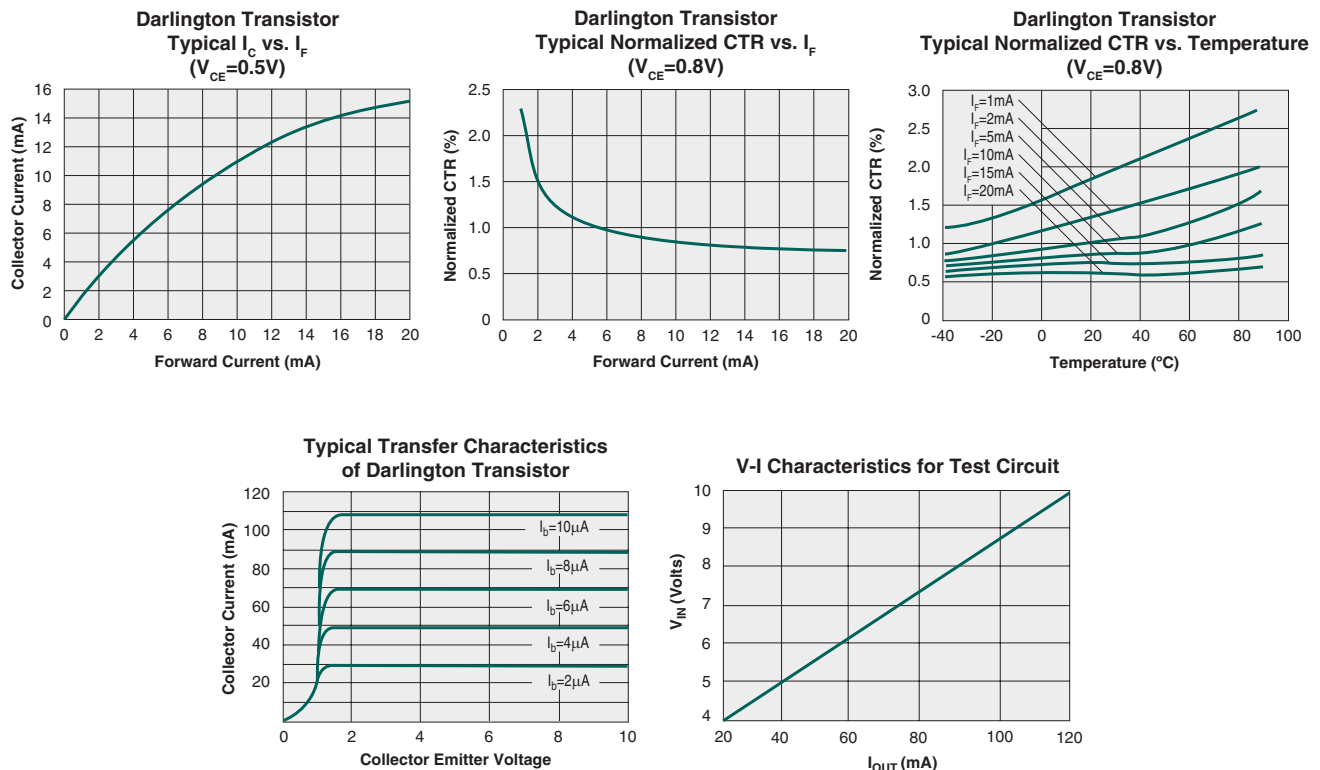

* The Performance data shown in the graphs above is typical of device performance. For guaranteed parameters not indicated in the written specifications, please contact our application department.

Manufacturing Information

Moisture Sensitivity



All plastic encapsulated semiconductor packages are susceptible to moisture ingress. IXYS Integrated Circuits Division classified all of its plastic encapsulated devices for moisture sensitivity according to the latest version of the joint industry standard, **IPC/JEDEC J-STD-020**, in force at the time of product evaluation. We test all of our products to the maximum conditions set forth in the standard, and guarantee proper operation of our devices when handled according to the limitations and information in that standard as well as to any limitations set forth in the information or standards referenced below.

Failure to adhere to the warnings or limitations as established by the listed specifications could result in reduced product performance, reduction of operable life, and/or reduction of overall reliability.

This product carries a **Moisture Sensitivity Level (MSL) rating** as shown below, and should be handled according to the requirements of the latest version of the joint industry standard **IPC/JEDEC J-STD-033**.

Device	Moisture Sensitivity Level (MSL) Rating
ITC137P	MSL 1

ESD Sensitivity



This product is **ESD Sensitive**, and should be handled according to the industry standard **JESD-625**.

Reflow Profile

This product has a maximum body temperature and time rating as shown below. All other guidelines of **J-STD-020** must be observed.

Device	Maximum Temperature x Time
ITC137P	260°C for 30 seconds

Board Wash

IXYS Integrated Circuits Division recommends the use of no-clean flux formulations. However, board washing to remove flux residue is acceptable. Since IXYS Integrated Circuits Division employs the use of silicone coating as an optical waveguide in many of its optically isolated products, the use of a short drying bake could be necessary if a wash is used after solder reflow processes. Chlorine- or Fluorine-based solvents or fluxes should not be used. Cleaning methods that employ ultrasonic energy should not be used.



MECHANICAL DIMENSIONS

ITC117P

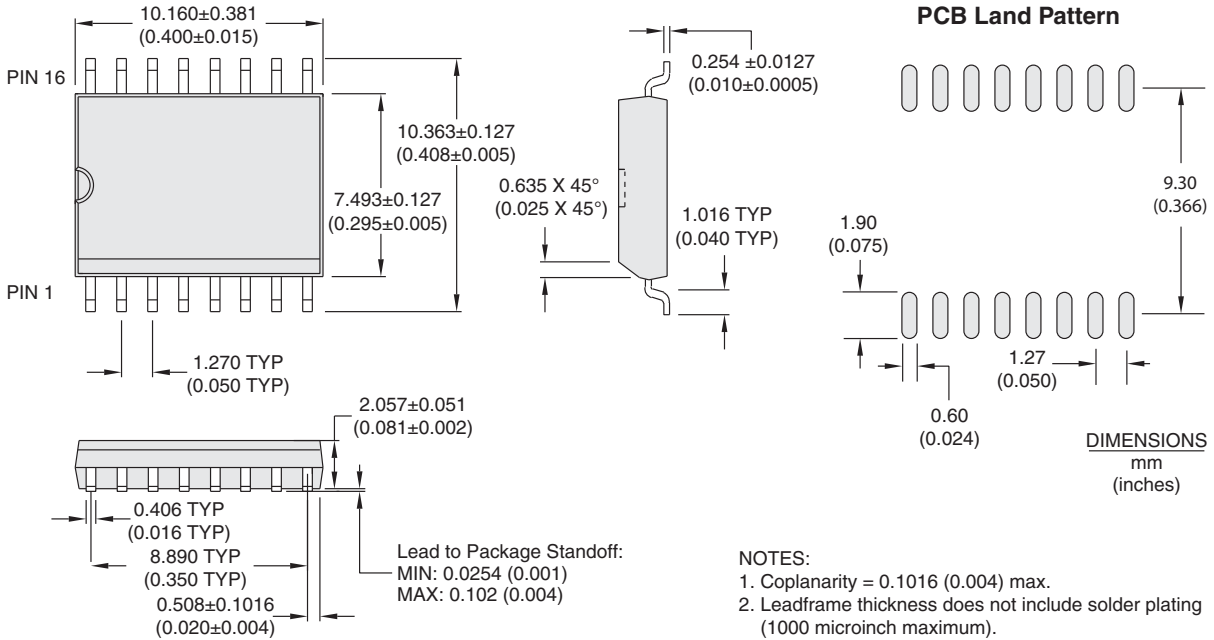

ITC117PTR Tape & Reel

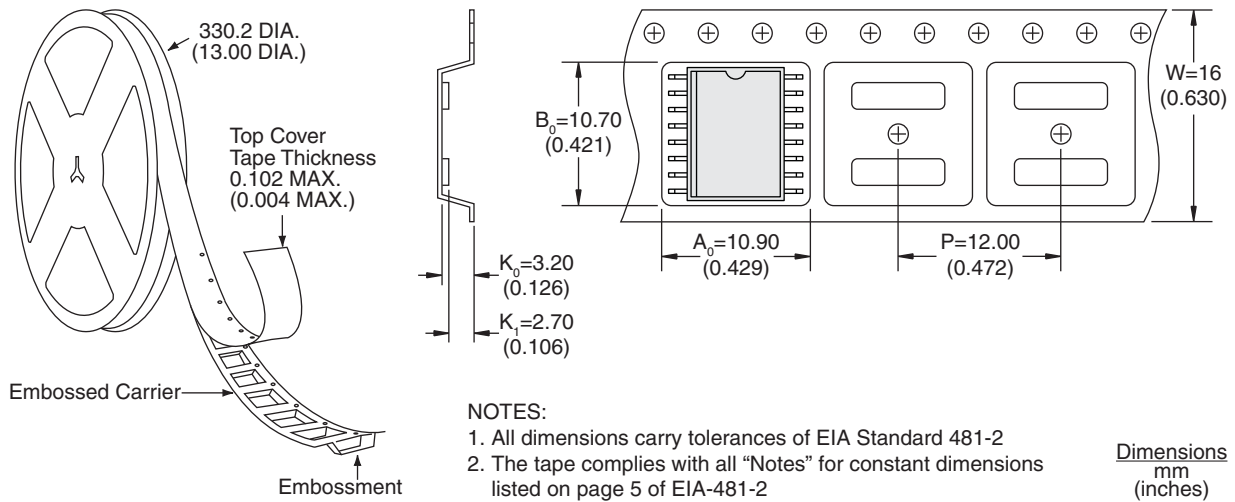

For additional information please visit our website at: www.ixysic.com

IXYS Integrated Circuits Division makes no representations or warranties with respect to the accuracy or completeness of the contents of this publication and reserves the right to make changes to specifications and product descriptions at any time without notice. Neither circuit patent licenses nor indemnity are expressed or implied. Except as set forth in IXYS Integrated Circuits Division's Standard Terms and Conditions of Sale, IXYS Integrated Circuits Division assumes no liability whatsoever, and disclaims any express or implied warranty, relating to its products including, but not limited to, the implied warranty of merchantability, fitness for a particular purpose, or infringement of any intellectual property right.

The products described in this document are not designed, intended, authorized or warranted for use as components in systems intended for surgical implant into the body, or in other applications intended to support or sustain life, or where malfunction of IXYS Integrated Circuits Division's product may result in direct physical harm, injury, or death to a person or severe property or environmental damage. IXYS Integrated Circuits Division reserves the right to discontinue or make changes to its products at any time without notice.