

Microsemi Power Portfolio 2016



Power Semiconductors

Power Modules

RF Power MOSFETs

About Microsemi

Microsemi Corporation (Nasdaq: MSCC) offers a comprehensive portfolio of semiconductor and system solutions for communications, defense and security, aerospace, and industrial markets. Products include high-performance and radiation-hardened analog mixed-signal integrated circuits, FPGAs, SoCs, and ASICs; power management products; timing and synchronization devices and precise time solutions; voice processing devices; RF solutions; discrete components; enterprise storage and communications solutions, security technologies, and scalable anti-tamper products; Ethernet solutions; Power-over-Ethernet ICs and midspans; custom design capabilities and services. Microsemi is headquartered in Aliso Viejo, California, and has approximately 4,800 employees worldwide. Learn more at www.microsemi.com.

CONTENTS

	Page No.
HIGH VOLTAGE SMPS TRANSISTORS	
IGBTs (Insulated Gate Bipolar Transistors).....	3-5
SiC and Power MOS 8™ MOSFETs / FREDFETs	6-8
Ultra-Fast Low Gate Charge MOSFETs	9
CoolMOS™ MOSFETs	10
High Voltage Linear MOSFETs	10
DIODES	
SiC Schottky and Ultra Fast Recovery Diodes	11-13
HIGH VOLTAGE RF MOSFETS	14
HIGH FREQUENCY RF MOSFETS	14
DRIVER-RF MOSFET HYBRIDS	15
REFERENCE DESIGN KITS	15
POWER MODULES	
Contents.....	16
Electrical Configuration	17
Packaging.....	18
Know How and Capabilities	19-20
Part Numbering System	21
IGBTs (Insulated Gate Bipolar Transistors)	22-25
MOSFETs	26-30
Renewable Energy Power Modules	30-31
SiC Power Modules.....	32-34
Diodes and Rectifiers	35
PACKAGE OUTLINE DRAWINGS	36-39

Insulated Gate Bipolar Transistors (IGBTs)

IGBTs from Microsemi

IGBT products from Microsemi provide high quality solutions for a wide range of high voltage, high power applications. The switching frequency range spans from DC for minimal conduction loss to 150kHz for very high power density SMPS applications. The frequency range for each product type is shown in the graph below. Each IGBT product represents the latest in IGBT technology, providing the best possible performance/cost combination for the targeted application. There are six product series that utilize three different IGBT technologies: Non-Punch-Through (NPT), Punch-Through (PT) and Field Stop.

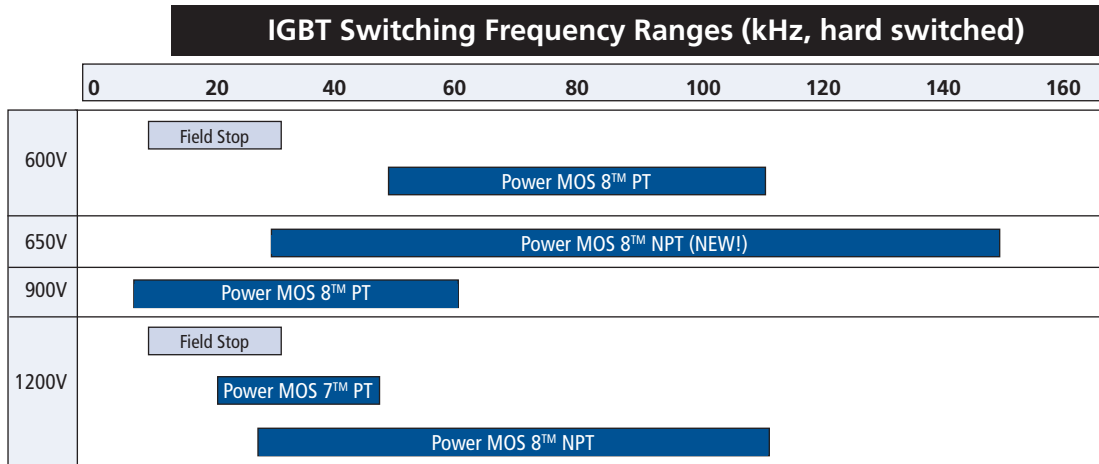

Note: Frequency ranges shown are typical for a 50A IGBT. Refer to product data sheet max frequency vs current graph for more information.

Standard Series	Voltage Ratings (V)	Technology	Easy to Parallel	Short Circuit SOA	Comment
MOS 7™	1200	PT			Ultra-low gate charge
MOS 8™	600, 650, 900, 1200	PT, NPT			Highest efficiency
Field Stop Trench Gate	600, 1200	Field Stop	X	X	Lowest conduction loss

Product Options

All standard IGBT products are available as a single IGBT or as a Combi product packaged with an anti-parallel DQ series diode. Package options include TO-220, TO-247, T-MAX®, TO-264, and SOT-227. Customized products are available; contact factory for details.

Insulated Gate Bipolar Transistors (IGBTs)

POWER MOS 8™

- NPT Technology
- High Speed Switching
- Low Switching Losses
- Easy to Parallel

BV_{CES} Volts	$V_{CE(ON)}$ Typ 25°C	I_{C2} 100°C	Maximum I_C at Frequency		Part Number	Package Style
POWER MOS 8™						
SINGLE						
650	1.9	45	150 kHz	200 kHz	APT45GR65B	TO-247
	1.9	70	100 kHz	150 kHz	APT70GR65B	TO-247
			50 kHz	100 kHz	APT95GR65B2	T-MAX®
	1.9	95	50 kHz	80 kHz		
1200	2.5	25	25	21	APT25GR120B	TO-247
	2.5	25	25	21	APT25GR120S	D ³
	2.5	40	38	28	APT40GR120B	TO-247
	2.5	40	38	28	APT40GR120S	D ³
	2.5	50	48	36	APT50GR120B2	T-MAX®
	2.5	50	48	36	APT50GR120L	TO-264
			25 kHz	50 kHz		
	2.5	70	66	42	APT70GR120B2	T-MAX®
	2.5	70	66	42	APT70GR120L	TO-264
	2.5	70*	42	30	APT70GR120J	ISOTOP®
	2.5	85	72	46	APT85GR120B2	T-MAX®
	2.5	85	72	46	APT85GR120L	TO-264
	2.5	85*	46	31	APT85GR120J	ISOTOP®
	Combi (IGBT & Diode)			150 kHz	200 kHz	
650	1.9	45	31	25	APT45GR65BSCD10	TO-247 (SiC SBD)
			100 kHz	150 kHz		
	1.9	45	30	18	APT45GR65B2DU30	T-MAX® (DU Diode)
	1.9	70	52	39	APT70GR65B2SCD30	T-MAX® (SiC SBD)
			50 kHz	100 kHz		
	1.9	70	59	38	APT70GR65B2DU40	T-MAX® (DU Diode)
1200			40 kHz	80 kHz		
	1.9	95	50	35	APT95GR65JDU60	ISOTOP® (DU Diode)
			50 kHz	80 kHz		
	2.5	25	25	21	APT25GR120BD15	TO-247 (DQ)
	2.5	25	25	21	APT25GR120SD15	D3 (DQ)
	2.5	25	25	21	APT25GR120BSCD10	TO-247 (SiC SBD)
	2.5	25	25	21	APT25GR120SSCD10	D3 (SiC SBD) v
	2.5	40	38	28	APT40GR120B2D30	T-MAX® (DQ)
	2.5	40	38	28	APT40GR120B2SCD10	T-MAX® (SiC SBD)
			25 kHz	50 kHz		
	2.5	50*	42	32	APT50GR120JD30	ISOTOP® (DQ)
	2.5	70*	42	30	APT70GR120JD60	ISOTOP® (DQ)
	2.5	85*	46	31	APT85GR120JD60	ISOTOP® (DQ)
	POWER MOS 8™					
SINGLE						
600	2.0	36	21	17	APT36GA60B	TO-247 or D ³
	2.0	44	26	20	APT44GA60B	TO-247 or D ³
	2.0	54	30	23	APT54GA60B	TO-247 or D ³
	2.0	68	35	27	APT68GA60B	TO-247 or D ³
	2.0	80	40	31	APT80GA60B	TO-247 or D ³
	2.0	102	51	39	APT102GA60B2	T-MAX® or TO-264
900			25 kHz	50 kHz		
	2.5	35	17	10	APT35GA90B	TO-247 or D ³
	2.5	43	21	13	APT43GA90B	TO-247 or D ³
	2.5	64	29	19	APT64GA90B	TO-247 or D ³
2.5	80	34	23	APT80GA90B	TO-247 or D ³	
Combi (IGBT & "DQ" FRED)			50 kHz	80 kHz		
600	2.0	36	21	17	APT36GA60BD15	TO-247 or D ³
	2.0	44	26	20	APT44GA60BD30	TO-247 or D ³
	2.0	54	30	23	APT54GA60BD30	TO-247 or D ³
	2.0	60	48	36	APT60GA60JD60	ISOTOP®
	2.0	68	35	27	APT68GA60B2D40	T-MAX® or TO-264
	2.0	80	40	31	APT80GA60LD40	TO-264
900			25 kHz	50 kHz		
	2.5	27	14	8	APT27GA90BD15	TO-247 or D ³
	2.5	35	17	10	APT35GA90BD15	TO-247 or D ³
	2.5	43	21	13	APT43GA90BD30	TO-247 or D ³
	2.5	46	33	21	APT46GA90JD40	ISOTOP®
	2.5	64	29	19	APT64GA90B2D30	T-MAX® or TO-264
2.5	80	34	23	APT80GA90LD40	TO-264	

Current @ Frequency Test Conditions: T_j = 125°C, T_c = 100°C except Isotop® where T_c = 80°C, V_{cc} = 67% rated voltage Hard Switch

* I_{C2} for ISOTOP® packages measured at 70°C for 1200V NPT IGBTs

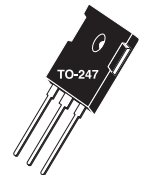

TO-247[B]



D³ PAK[S]

Part Numbers for D³ packages - replace "B" with "S" in part number

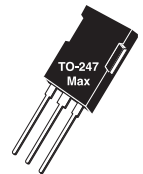

T-MAX®[B2]

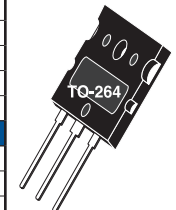

TO-264[L]

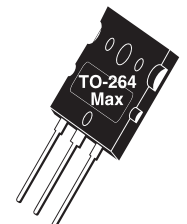

264-MAX™[L2]

Part Numbers for TO-264 packages - replace "B2" with "L" in part number

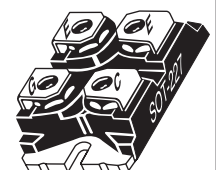

ISOTOP®[J]
SOT-227

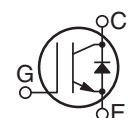

Insulated Gate Bipolar Transistors (IGBTs)

FIELD STOP

- Trench Technology
- Short Circuit Rated
- Lowest Conduction Loss
- Easy Paralleling
- Combi with High Speed DQ Diode

BV _{CES} Volts	V _{CE(ON)} Typ 25°C	I _{C2} 100°C	Maximum I _C at Frequency		Part Number	Package Style
			15 kHz	30 kHz		
SINGLE						
600	1.5	24	15	10	APT20GN60BG	TO-247
	1.5	37	20	14	APT30GN60BG	TO-247
	1.5	64	30	21	APT50GN60BG	TO-247
	1.5	93	42	30	APT75GN60BG	TO-247
	1.5	123	75	47	APT150GN60J	ISOTOP®
	1.5	135	54	39	APT100GN60B2G	T-MAX®
	1.5	190	79	57	APT150GN60B2G	T-MAX®
	1.5	230	103	75	APT200GN60B2G	T-MAX®
1.5	158	100	66	APT200GN60J	ISOTOP®	
10 kHz 20 kHz						
1200	1.7	33	19	13	APT25GN120BG	TO-247 or D ³
	1.7	46	24	17	APT35GN120BG	TO-247
	1.7	66	32	22	APT50GN120B2G	T-MAX®
	1.7	70	44	27	APT100GN120J	ISOTOP®
	1.7	99	45	30	APT75GN120B2G	T-MAX® or TO-264
	1.7	120	58	38	APT100GN120B2G	T-MAX®
	1.7	99	60	36	APT150GN120J	ISOTOP®
Combi (IGBT & "DQ" FRED)						
			15 kHz	30 kHz		
600	1.5	24	15	10	APT20GN60BDQ1G	TO-247
	1.5	37	20	14	APT30GN60BDQ2G	TO-247
	1.5	64	30	21	APT50GN60BDQ2G	TO-247
	1.5	93	42	30	APT75GN60LDQ3G	TO-264
	1.5	123	75	47	APT150GN60JDQ4	ISOTOP®
	1.5	135	54	39	APT100GN60LDQ4G	TO-264v
	1.5	190	79	57	APT150GN60LDQ4G	TO-264
	1.5	158	100	66	APT200GN60JDQ4	ISOTOP®
10 kHz 20 kHz						
1200	1.7	22	14	10	APT15GN120BDQ1G	TO-247 or D ³
	1.7	33	19	13	APT25GN120B2DQ2G	T-MAX®
	1.7	46	24	17	APT35GN120L2DQ2G	264-MAX™
	1.7	57	36	22	APT75GN120JDQ3	ISOTOP®
	1.7	66	32	22	APT50GN120L2DQ2G	264-MAX™
	1.7	70	44	27	APT100GN120JDQ4	ISOTOP®
	1.7	99	60	36	APT150GN120JDQ4	ISOTOP®
	SINGLE					
			20 kHz	40 kHz		
1200	3.3	33	19	12	APT25GP120BG	TO-247
	3.3	46	24	15	APT35GP120BG	TO-247
	3.3	54	29	18	APT45GP120BG	TO-247
	3.3	34	28	18	APT45GP120J	ISOTOP
	3.3	91	42	24	APT75GP120B2G	T-MAX®
	3.3	57	40	23	APT75GP120J	ISOTOP
Combi (IGBT & "DQ" FRED)						
			20 kHz	40 kHz		
1200	3.3	33	19	12	APT25GP120BDQ1G	TO-247
	3.3	46	24	15	APT35GP120B2DQ2G	T-MAX®
	3.3	54	29	18	APT45GP120B2DQ2G	T-MAX®
	3.3	34	28	18	APT45GP120JDQ2	ISOTOP
	3.3	57	40	23	APT75GP120JDQ3	ISOTOP

Power MOS 7® and IGBT

- PT Technology
- Ultra-low Gate Charge
- Combi with High Speed DQ Diode



D³ PAK[S]

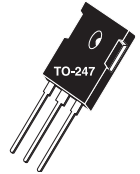

TO-247[B]

Part Numbers for D³ packages - replace "B" with "S" in part number



T-MAX®[B2]

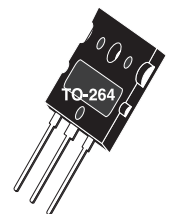

TO-264[L]

Part Numbers for L packages - replace "B2" with "L" in part number



ISOTOP®[J]
SOT-227

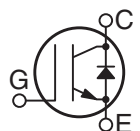

Current @ Frequency Test Conditions: T_j = 125°C, T_c = 100°C except Isotop® where T_c = 80°C, V_{cc} = 67% rated voltage Hard Switch

Silicon Carbide (SiC) MOSFETs

$BV_{(DSS)}$ Volts	$R_{DS(ON)}$ Ohms	$I_{D(Cont)}$ Amps	Part Number	Package Style
700V	0.100	35	APT35SM70B	TO-247
	0.100	35	APT35SM70S	D3
	0.053	70	APT70SM70B	TO-247
	0.053	70	APT70SM70S	D3
	0.053	70	APT70SM70J	ISOTOP®
	0.033	130	APT130SM70B	TO-247
	0.033	130	APT130SM70J	ISOTOP®
1200V	0.140	25	APT25SM120B	TO-247
	0.140	25	APT25SM120S	D3
	0.080	40	APT40SM120B	TO-247
	0.080	40	APT40SM120S	D3
	0.080	40	APT40SM120J	ISOTOP®
	0.040	80	APT80SM120B	TO-247
	0.040	80	APT80SM120S	D3
	0.040	80	APT80SM120J	ISOTOP®
1700V	0.800	5	APT5SM170B	TO-247
	0.800	5	APT5SM170S	D3

Microsemi Patented Technology. Manufactured in Bend, Oregon USA

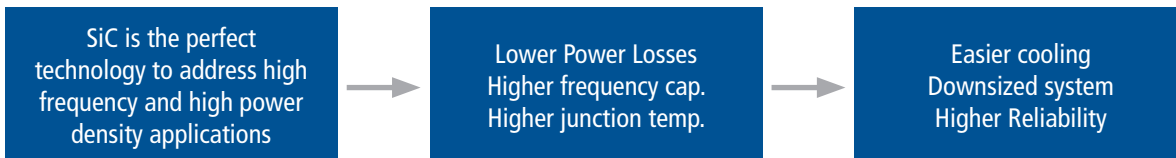



SiC MOSFETs

Characteristics	SiC vs. Si	Results	Benefits
Breakdown field (MV/cm)	10x Higher	Lower On-Resistance	Higher efficiency
Electron sat. velocity (cm/s)	2x Higher	Faster switching	Size reduction
Bandgap energy (ev)	3x Higher	Higher Junction Temperature	Improved cooling
Thermal conductivity (W/m.K)	3x Higher	Higher power density	Higher current capabilities
Positive Temperature coefficient	-	Self regulation	Easy paralleling

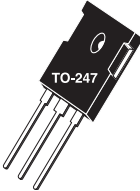

Microsemi Advantages Vs. Competition

- Lowest Conduction Losses at High Temperature
- Low Switching Losses
- Highest Short Circuit Withstand Rating
- Lowest Gate Resistance
- Patented SiC Technology

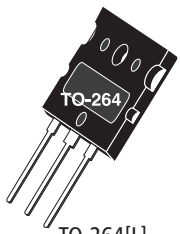
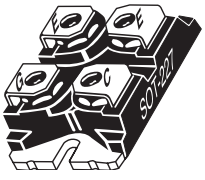
Power MOS 8™ MOSFETs / FREDFETs

BV _(DSS) Volts	R _{DS(ON)} Max	I _D	MOSFET Part #	I _D	FREDFET Part #	Package Style	
1200	2.40			7	APT7F120B	TO-247 or D ³	 TO-247[B]  D ³ PAK[S]
	2.10	8	APT7M120B			TO-247	
	1.20			14	APT13F120B	TO-247 or D ³	
	1.10	14	APT14M120B			TO-247	
	0.70			23	APT22F120B2	T-MAX® or TO-264	
	0.63	24	APT24M120B2			T-MAX® or TO-264	
	0.58			27	APT26F120B2	T-MAX® or TO-264	
	0.58			18	APT17F120J	ISOTOP®	
	0.53	29	APT28M120B2			T-MAX® or TO-264	
	0.53	19	APT19M120J			ISOTOP®	
	0.32			33	APT32F120J	ISOTOP®	
	0.29	35	APT34M120J			ISOTOP®	
1000	2.00			7	APT7F100B	TO-247	Part Numbers for D ³ packages - replace "B" with "S" in part number  T-MAX® [B2]  TO-264[L]
	1.80	8	APT8M100B			TO-247	
	1.60			9	APT9F100B	TO-247 or D ³	
	1.40	9	APT9M100B			TO-247	
	0.98			14	APT14F100B	TO-247 or D ³	
	0.88	14	APT14M100B			TO-247 or D ³	
	0.78			17	APT17F100B	TO-247 or D ³	
	0.70	18	APT18M100B			TO-247	
	0.44			30	APT29F100B2	T-MAX® or TO-264	
	0.44			20	APT19F100J	ISOTOP®	
	0.38	32	APT31M100B2	35	APT34F100B2	T-MAX® or TO-264	
	0.38	21	APT21M100J	23	APT22F100J	ISOTOP®	
	0.33	37	APT37M100B2			T-MAX® or TO-264	
	0.33	25	APT25M100J			ISOTOP®	
	0.20			42	APT41F100J	ISOTOP®	
0.18	45	APT45M100J			ISOTOP®		
800	0.90			12	APT11F80B	TO-247 or D ³	Part Numbers for TO-264 packages - replace "B2" with "L" in part number  ISOTOP® [J] SOT-227 (ISOLATED BASE)
	0.80	13	APT12M80B			TO-247	
	0.58			18	APT17F80B	TO-247 or D ³	
	0.53	19	APT18M80B			TO-247 or D ³	
	0.43			23	APT22F80B	TO-247 or D ³	
	0.39	25	APT24M80B			TO-247 or D ³	
	0.24			41	APT38F80B2	T-MAX® or TO-264	
	0.21	43	APT41M80B2	47	APT44F80B2	T-MAX® or TO-264	
	0.21			31	APT29F80J	ISOTOP®	
	0.19	49	APT48M80B2			T-MAX® or TO-264	
	0.19	33	APT32M80J			ISOTOP®	
	0.11			57	APT53F80J	ISOTOP®	
	0.10	60	APT58M80J			ISOTOP®	

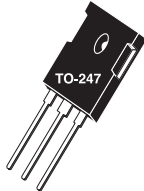
Power MOS 8™ MOSFETs / FREDFETs

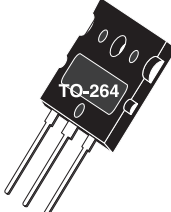
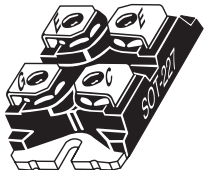
BV _(DSS) Volts	R _{DS(ON)} Max	I _D	MOSFET Part #	I _D	FREDFET Part #	Package Style	
600	0.43			16	APT15F60B	TO-247 or D ³	 TO-247[B]  D ³ PAK[S]
	0.37			19	APT18F60B	TO-247 or D ³	
	0.29			24	APT23F60B	TO-247 or D ³	
	0.22			30	APT28F60B	TO-247 or D ³	
	0.19	36	APT34M60B	36	APT34F60B	TO-247	
	0.15	45	APT43M60B2	45	APT43F60B2	T-MAX® or TO-264	
	0.15	31	APT30M60J	31	APT30F60J	ISOTOP®	
	0.11	60	APT56M60B2	60	APT56F60B2	T-MAX® or TO-264	
	0.11	42	APT39M60J	42	APT39F60J	ISOTOP®	
	0.09	70	APT66M60B2	70	APT66F60B2	T-MAX® or TO-264	
	0.09	49	APT47M60J	49	APT47F60J	ISOTOP®	
0.055	84	APT80M60J	84	APT80F60J	ISOTOP®		
500	0.24			24	APT24F50B	TO-247 or D ³	Part Numbers for D ³ packages - replace "B" with "S" in part number  T-MAX®[B2]
	0.19			30	APT30F50B	TO-247 or D ³	
	0.15			37	APT37F50B	TO-247 or D ³	
	0.13			43	APT42F50B	TO-247 or D ³	
	0.10	56	APT56M50B2	56	APT56F50B2	T-MAX® or TO-264	
	0.10	38	APT38M50J	38	APT38F50J	ISOTOP®	
	0.075	75	APT75M50B2	75	APT75F50B2	T-MAX® or TO-264	
	0.075	51	APT51M50J	51	APT51F50J	ISOTOP®	
	0.062	84	APT84M50B2	84	APT84F50B2	T-MAX® or TO-264	
	0.062	58	APT58M50J	58	APT58F50J	ISOTOP®	
	0.036	103	APT100M50J	103	APT100F50J	ISOTOP®	
<h3>Low Voltage Power MOS V® MOSFETs / FREDFETs</h3>							 TO-264[L] Part Numbers for TO-264 packages - replace "B2" with "L" in part number  ISOTOP®[J] SOT-227 (ISOLATED BASE)
300	0.085	40	APT30M85BVVRG	40	APT30M85BVFRG	TO-247	
	0.070	48	APT30M70BVVRG	48	APT30M70BVFRG	TO-247 or D ³	
	0.040	70	APT30M40JVVRG	70	APT30M40JVFRG	ISOTOP®	
	0.019	130	APT30M19JVVR	130	APT30M19JVFR	ISOTOP®	
200	0.045	56	APT20M45BVVRG	56	APT20M45BVFRG	TO-247	
	0.038	67	APT20M38BVVRG	37	APT20M38BVFRG	TO-247 or D ³ or T/R	
	0.022	100	APT20M22B2VVRG	100	APT20M22B2VFRG	T-MAX® or TO-264	
	0.011	175	APT20M11JVVR	175	APT20M11JVFR	ISOTOP®	

Ultrafast, Low Gate Charge MOSFETs

FOR 250 kHz - 2 MHz SWITCHING APPLICATIONS

The Ultrafast, Low Gate Charge MOSFET family combines the lowest gate charge available in the industry with Microsemi's proprietary self-aligned aluminum metal gate structure. The result is a MOSFET capable of extremely fast switching speeds and very low switching losses. The metal gate structure and the layout of these chips provide an internal series gate resistance (EGR) an order of magnitude lower than competitive devices built with a polysilicon gate.

These devices are ideally suited for high frequency and pulsed high voltage applications.

Typical Applications:

- Class D amplifiers up to 2 MHz
- High voltage pulsed DC
- AM transmitters
- Plasma deposition/etch

FEATURES:	BENEFITS:
<ul style="list-style-type: none"> • Series Gate Resistance (Rg) <0.1 ohm 	<ul style="list-style-type: none"> • Fast switching, uniform signal propagation
<ul style="list-style-type: none"> • Tr and Tf times of <10ns 	<ul style="list-style-type: none"> • Pulse power applications
<ul style="list-style-type: none"> • Industry's Lowest Gate Charge 	<ul style="list-style-type: none"> • Fast switching, reduced gate drive power

BV _(DSS) Volts	R _{DS(ON)} Max	I _D	MOSFET Part #	FREDFET Part #	Package Style
1200	4.700	3.5		APT1204R7BFLLG	TO-247 or D ³
	1.400	9		APT1201R4BFLLG	TO-247
	0.670	18	APT12067B2LLG		T-MAX®
	0.670	17	APT12067JLL		ISOTOP®
	0.570	22	APT12057B2LLG		T-MAX®
	0.570	19	APT12057JLL		ISOTOP®
1000	0.900	12	APT10090BLLG		TO-247
	0.780	14	APT10078BLLG		TO-247 or D ³
	0.450	23	APT10045B2LLG		T-MAX® or TO-264
	0.450	21	APT10045JLL		ISOTOP®
	0.350	28	APT10035B2LLG		T-MAX®
	0.350	25	APT10035JLL		ISOTOP®
	0.260	38		APT10026L2FLLG	TO-264 MAX
	0.260	30	APT10026JLL	APT10026JFLL	ISOTOP®
	0.210	37	APT10021JLL	APT10021JFLL	ISOTOP®
800	0.140	52	APT8014L2LLLG	APT8014L2FLLG	TO-264 MAX
	0.110	51	APT8011JLL	APT8011JFLL	T-MAX® or TO-264
	0.200	38	APT8020B2LL		T-MAX®
	0.200	33	APT8020JLL		ISOTOP® or D ³ or T/R
500	0.140	35	APT5014BLLG		TO-247
	0.100	46	APT5010B2LLG	APT5010B2FLLG	T-MAX® or TO-264
	0.065	67	APT50M65B2LLG	APT50M65B2FLLG	T-MAX® or TO-264
	0.065	58	APT50M65JLLG	APT50M65JFLLG	ISOTOP®
	0.075	51	APT50M75JLL	APT50M75JFLL	ISOTOP®
	0.075	57	APT50M75B2LLG		T-MAX® or TO-264
	0.050	71	APT50M50JLL		ISOTOP®
	0.038	88	APT50M38JLL		ISOTOP®

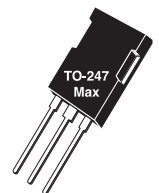

T-MAX®[B2]

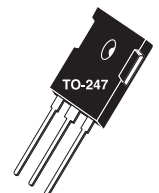

TO-247[B]

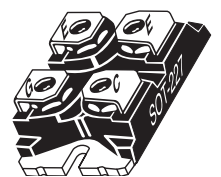

ISOTOP® [J]
SOT-227
(ISOLATED BASE)

BV _{DSS} Volts	R _{DS(ON)} Ohms	I _{D(Cont)} Amps	Part Number	Package Style
C3 TECHNOLOGY				
900	0.120	36	APT36N90BC3G	TO-247
800	0.450	11	APT11N80BC3G	TO-247
	0.145	34	APT34N80B2C3G	T-MAX [®] or TO-264
	0.145	34	APT34N80LC3G	TO-264
650	0.035	94	APT94N65B2C3G	T-MAX [®] or TO-264
	0.070	47	APT47N65BC3G	TO-247 or D ³
	0.070	47	APT47N60BC3G	TO-247 or D ³
600	0.035	77	APT77N60JC3	ISOTOP [®]
	0.042	94	APT94N60L2C3G	264-MAX [™]
SERVER SERIES				
	0.045	60	APT60N60BCSG	TO-247 or D ³ or T/R
C6 TECHNOLOGY				
600	0.041	77	APT77N60BC6	TO-247 or D ³
	0.070	53	APT53N60BC6	TO-247 or D ³
	0.099	38	APT38N60BC6	TO-247 or D ³
	0.125	30	APT30N60BC6	TO-247 or D ³
	0.035	106	APT106N60B2C6	T-MAX [™] or TO-264
650	0.041	85	APT97N65B2C6	T-MAX [™] or TO-264
	0.035	94	APT94N65B2C6	T-MAX [™]



D³ PAK[S]
TO-268

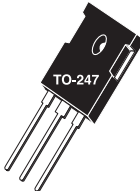

TO-247



TO-247
Max

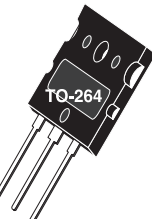

TO-247[B]

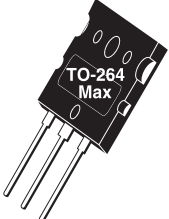

T-MAX[®][B2]

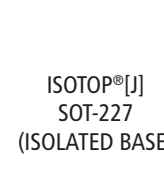

TO-264

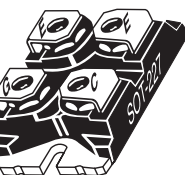

264-MAX[™] [L2]

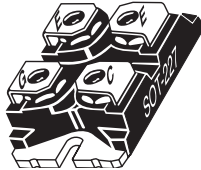

ISOTOP[®][J]
SOT-227
(ISOLATED BASE)

"CoolMOS" comprise a new family of transistors developed by Infineon Technologies AG.
"CoolMOS" is a trademark of Infineon Technologies AG.

Linear MOSFETs

What is a Linear MOSFET?

A MOSFET specifically designed to be more robust than a standard MOSFET when operated with both high voltage and high current near DC conditions (>100msecs).

The Problem with SMPS MOSFETs

MOSFETs optimized for high frequency SMPS applications have poor high voltage DC SOA. Most SMPS type MOSFETs over-state SOA capability at high voltage on the data sheets. Above ~30V and DC conditions, SOA drops faster than is indicated by P_D limited operation.

For pulsed loads (t<10ms) there is generally no problem using a standard MOSFET.

Technology Innovation

Introduced in 1999, Microsemi modified its proprietary patented self-aligned metal gate MOSFET technology for enhanced performance in high voltage, linear applications. These Linear MOSFETs typically provide 1.5-2.0 times the DC SOA capability at high voltage compared to other MOSFET technologies optimized for switching applications.

Designers will need Linear MOSFETs when...

- High Current & > 200V >100msec
- Used as a variable power resistor
- Soft start application (limit surge currents)
- Linear amplifier circuit

Typical Applications...

- Active loads above 200 volts such as DC dynamic loads for testing power supplies, batteries, fuel cells, etc.
- High voltage, high current constant current sources.

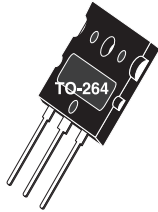
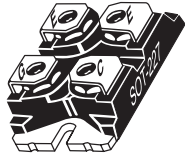
BV _{DSS} Volts	R _{DS(ON)} Ohms	I _{D(Cont)} Amps	SOA Watts	Part Number	Package Style
1000	0.600	18	325	APL1001J	 <p>TO-247 Max</p>  <p>TO-264</p>  <p>ISOTOP[®][J] SOT-227 (ISOLATED BASE)</p>
600	0.125	49	325	APL602B2G	
	0.125	43	325	APL602J	
500	0.090	58	325	APL502B2G	
	0.090	52	325	APL502J	
Part Numbers for TO-264 packages - replace "B2" with "L" in part number					

Ultra Fast Recovery Diodes

Microsemi PPG offers five series of discrete diode products: a new DL series low V_F ultra-soft recovery, the medium speed medium V_F D series, the high speed DQ series, the very high speed DS series, and the silicon Schottky S series. These series of diodes are designed to provide high quality solutions to a wide range of high voltage, high power application requirements, ranging from fast recovery for continuous conduction mode power factor correction to low conduction loss for output rectification. Distinguishing features, technology used, and applications for each product family are summarized in the table below.

Series	Voltage Ratings	Features	Applications	Comment
DL	600	Low V_F Ultra-soft recovery Avalanche Rated	Output rectifier Resonant circuits	Ultra-soft recovery minimizes or eliminates snubber
D	200, 300, 400, 600, 1000, 1200	Medium V_F Medium Speed	Freewheeling Diode Output rectifier DC-DC converter	Proprietary platinum process
DQ	600, 1000, 1200	High speed Avalanche Rated	PFC Freewheeling Diode DC-DC converter	Stepped epi improves softness Proprietary platinum process
DS	600	Very high speed	High frequency PFC	Proprietary platinum process
Schottky	200	Low V_F Avalanche rated	Output rectifier Freewheeling Diode DC-DC converter	
SiC Schottky	650, 1200, 1700	Zero Reverse Recovery	PFC, Freewheeling Diode DC-DC converter	Low switching losses, high power density and high temperature operation

The graph below shows the relative recovery speed and forward voltage positions of 600V DL, D, DQ and DS series diodes.

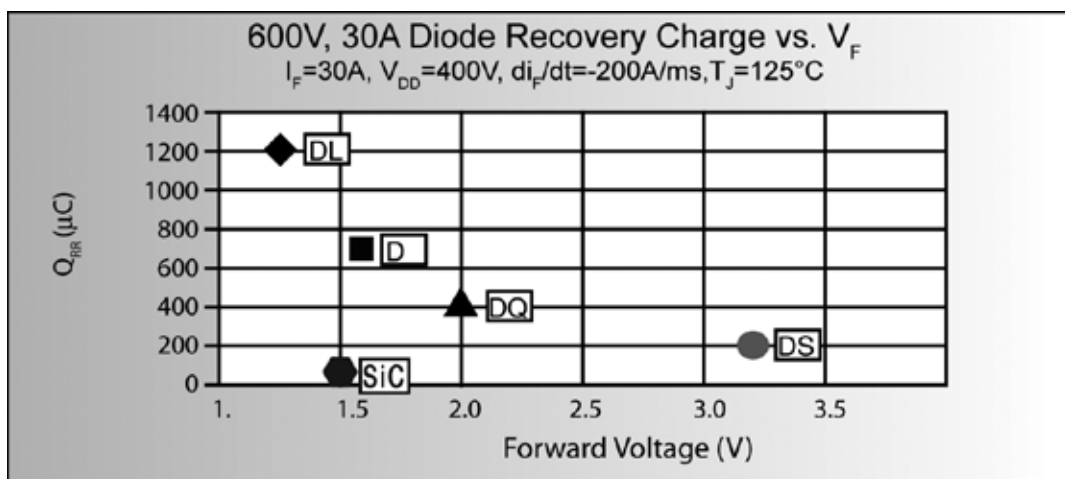

SIC SCHOTTKY Diodes

SIC SCHOTTKY DIODES					
Volts	I _{F (avg)} Amps	V _F volts Typ 25° C	Diode Series	Part Number	Package Style
SINGLE					
1700	10	1.5	SCE	APT10SCE170B	TO-247
1200	10	1.5	SCD	APT10SCD120B	TO-247
	10	1.5	SCD	APT10SCD120K	TO-220
	20	1.5	SCD	APT20SCD120B	TO-247
	20	1.5	SCD	APT20SCD120S	D ³
	30	1.5	SCD	APT30SCD120B	TO-247
	30	1.5	SCD	APT30SCD120S	D ³
650	10	1.5	SCD	APT10SCD65K	TO-220
	20	1.5	SCD	APT20SCD65K	TO-220
	30	1.5	SCD	APT30SCD65B	TO-247
DUAL					
1200	2 x 10	1.5	SCD	APT10SCD120BCT	TO-247

Ultra Fast Recovery Diodes

Volts	I _{F (avg)} Amps	V _F (volts) Typ 25°C	t _{RR} (ns) Typ 25°C	Q _{RR} (nC) Typ 125°C at I _F = I _{F (avg)}	Diode Series	Part Number	Package Style
SINGLE							
1200	15	2.8	21	960	DQ	APT15DQ120BG	TO-247
	15	2.8	21	960	DQ	APT15DQ120KG	TO-220
	15	2.0	32	1300	D	APT15D120BG	TO-247
	15	2.0	32	1300	D	APT15D120KG	TO-220
	30	2.8	24	1800	DQ	APT30DQ120BG	TO-247
	30	2.8	24	1800	DQ	APT30DQ120KG	TO-220
	30	2.0	31	3450	D	APT30D120BG	TO-247
	40	2.8	26	2200	DQ	APT40DQ120BG	TO-247
	60	2.8	30	2800	DQ	APT60DQ120BG	TO-247
	60	2.0	38	4000	D	APT60D120BG	TO-247 or D ³
1000	15	2.5	20	810	DQ	APT15DQ100BG	TO-247
	15	2.5	20	810	DQ	APT15DQ100KG	TO-220
	15	1.9	28	1550	D	APT15D100KG	TO-220
	30	2.5	22	1250	DQ	APT30DQ100BG	TO-247
	30	2.5	22	1250	DQ	APT30DQ100KG	TO-247
	30	1.9	29	2350	D	APT30D100BG	TO-247
	40	2.5	24	1430	DQ	APT40DQ100BG	TO-247
	60	2.5	29	2325	DQ	APT60DQ100BG	TO-247
	60	1.9	34	3600	D	APT60D100BG	TO-247 or D ³
	75	2.5	33	2660	DQ	APT75DQ100BG	TO-247
600	15	2.0	16	250	DQ	APT15DQ60BG	TO-247
	15	2.0	16	250	DQ	APT15DQ60KG	TO-220
	15	1.6	21	520	D	APT15D60BG	TO-247
	15	1.6	21	520	D	APT15D60KG	TO-220
	30	2.0	19	400	DQ	APT30DQ60BG	TO-247
	30	2.0	19	400	DQ	APT30DQ60KG	TO-220
	30	1.6	23	700	D	APT30D60BG	TO-247
	40	2.0	22	480	DQ	APT40DQ60BG	TO-247
	60	2.0	26	640	DQ	APT60DQ60BG	TO-247
	60	1.6	40	920	D	APT60D60BG	TO-247 or D ³
400	75	2.0	29	650	DQ	APT75DQ60BG	TO-247
	100	1.25	45	3800	DL	APT100DL60BG	TO-247
	30	1.3	22	360	D	APT30D40BG	TO-247
	60	1.3	30	540	D	APT60D40BG	TO-247
200	30	1.1	21	150	D	APT30D20BG	TO-247
	30	0.83	25	448	Schottky	APT30S20BG	TO-247 or D ³
	60	1.1	30	250	D	APT60D20BG	TO-247
	60	0.83	35	490	Schottky	APT60S20BG	TO-247 or D ³ or T/R
	100	0.89	40	690	Schottky	APT100S20BG	TO-247

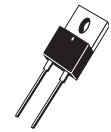

TO-220[K]



D³ PAK[S]
TO-268

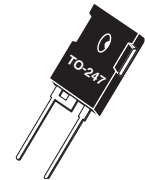

TO-247[B]



T-MAX@[B2]

Part Numbers for D³ packages
- replace "B" with "S" in part
number

Ultra Fast Recovery Diodes

Volts	I _F (avg) Amps	V _F (volts) Typ 25°C	t _{RR} (ns) Typ 25°C	Q _{RR} (nC) Typ 125°C at I _F = I _F (avg)	Diode Series	Part Number	Package Style
DUAL	2x27	2.0	31	3450	D	APT2X30D120J	ISOTOP® Antiparallel Configuration (ISOLATED BASE)
1200	2x30	2.6	25	1800	DQ	APT2X30DQ120J	
	2x53	2.0	38	4000	D	APT2X60D120J	
	2x60	2.5	30	2890	DQ	APT2X60DQ120J	
	2x93	2.0	47	5350	D	APT2X100D120J	
	2x100	2.4	45	5240	DQ	APT2X100DQ120J	
	1000	2x28	1.9	29	2350	D	
2x55		1.9	34	3600	D	APT2X60D100J	
2x60		2.2	30	2350	DQ	APT2X60DQ100J	
2x95		1.9	43	4050	D	APT2X100D100J	
2x100		2.1	45	3645	DQ	APT2X100DQ100J	
600	2x30	1.8	20	400	DQ	APT2X30DQ60J	
	2x30	1.6	23	700	D	APT2X30D60J	
	2x60	1.7	27	650	DQ	APT2X60DQ60J	
	2x60	1.6	40	920	D	APT2X60D60J	
	2x100	1.6	30	980	DQ	APT2X100DQ60J	
	2x100	1.6	34	1450	D	APT2X100D60J	
	2x150	1.25	53	3800	DL	APT2X150DL60J	
400	2x30	1.3	22	360	D	APT2X30D40J	
	2x60	1.3	30	540	D	APT2X60D40J	
	2x100	1.3	37	1050	D	APT2X100D40J	
	2x100	1.0	40	3550	DL	APT2X101DL40J ⁺⁺	
300	2x100	1.2	36	650	D	APT2X101D30J	
200	2x30	0.80	25	448	Schottky	APT2X31S20J	
	2x60	0.83	35	490	Schottky	APT2X61S20J	
	2x100	1.1	39	840	D	APT2X100D20J	
	2x100	0.89	40	690	Schottky	APT2X101S20J	
1200	2x30	2.8	26	2100	DQ	APT30DQ120BCTG	TO-247 [BCT]
1000	2x15	2.5	20	810	DQ	APT15DQ100BCTG	TO-247 [BCT]
	2x15	1.9	28	1550	D	APT15D100BCTG	TO-247 [BHB]
	2x30	1.9	29	2360	D	APT30D100BCTG	TO-247 [BHB]
	2x30	1.9	30	2350	D	APT30D100BHBG	TO-247 [BCA]
	2x60	2.5	29	2325	DQ	APT60DQ100LCTG	TO-264 [LCT]
	2x60	1.9	35	3600	D	APT60D100LCTG	TO-264 [LCT]
600	2x15	1.6	21	520	D	APT15D60BCTG	TO-247
	2x15	2.0	15	250	DQ	APT15DQ60BCTG	TO-247 [BCT]
	2x15	1.6	20	520	D	APT15D60BCAG	TO-247 [BCA]
	2x30	2.0	22	480	DQ	APT30DQ60BHBG	TO-247 [BHB]
	2x30	2.0	19	400	DQ	APT30DQ60BCTG	TO-247 [BCT]
	2x30	1.6	23	700	D	APT30D60BCTG	TO-247 [BCT]
	2x30	1.6	25	700	D	APT30D60BHBG	TO-247 [BHB]
	2x30	1.6	25	700	D	APT30D60BCAG	TO-247 [BCA]
	2x40	2.0	22	480	DQ	APT40DQ60BCTG	TO-247 [BCT]
	2x60	2.0	26	640	DQ	APT60DQ60BCTG	TO-247 [BCT]
2x60	1.6	30	920	D	APT60D60LCTG	TO-264 [LCT]	
400	2x30	1.3	22	360	D	APT30D40BCTG	TO-247 [BCT]
	2x60	1.3	30	540	D	APT60D40LCTG	TO-264 [LCT]
300	2x30	1.2	25	1300	D	APT30D30BCTG	TO-247 [BCT]
200	2x30	1.1	21	150	D	APT30D20BCTG	TO-247 [BCT]
	2x30	1.1	21	150	D	APT30D20BCAG	TO-247 [BCA]
	2x30	0.80	25	448	Schottky	APT30S20BCTG	TO-247 [BCT]
	2x60	0.83	35	490	Schottky	APT60S20B2CTG	T-MAX® [B2CT]
	2x100	0.89	40	690	Schottky	APT100S20LCTG	TO-264[LCT]
TANDEM, DS DIODES FOR PFC BOOST APPLICATIONS							
600	15	3.2	13	85	DS	APT15DS60BG	TO-247
	30	3.2	17	180	DS	APT30DS60BG	TO-247
(2, 300V Diodes Connected In Series)							

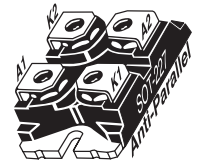

ISOTOP®[J] SOT-227
Antiparallel
Configuration
(ISOLATED BASE)

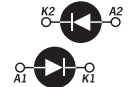

Part Numbers for Parallel
Configuration replace 30, 60,
or 100 with 31, 61, or 101.
Except Schottky

Example: 2X30D120J
becomes 2X31D120J

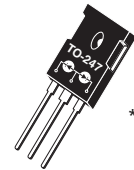

TO-247 [BCA]
*Common Anode

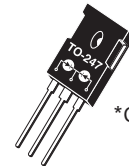

TO-247 [BCT]
*Common Cathode

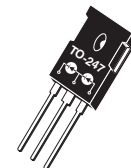

TO-247 [BHB]
*Half Bridge

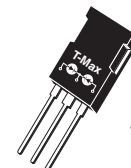

T-MAX® [B2CT]
*Common Cathode

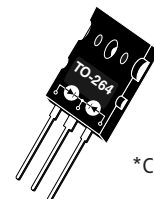

TO-264 [LCT]
*Common Cathode

Part Numbers for D³
packages - replace "B"
with "S" in part number

High Voltage RF MOSFETs

The ARF family of RF Power MOSFETs are optimized for applications requiring frequencies as high as 150MHz and operating voltages as high as 400V. Historically, RF Power MOSFETs were limited to applications of 50V or less. This limitation has been removed by combining Microsemi's high voltage MOSFET technology with RF specific die geometries.

Why Higher Voltage? Higher V_{DD} means higher load impedance. For 150W output from a 50V supply, the load impedance is only 8 ohms. At 125V, the load impedance is 50 ohms. The higher impedance allows simpler transformers and combiners. Paralleled devices can still operate into reasonable and convenient impedances. The increased operating voltage also lowers the DC current required for any given power output, increasing efficiency and reducing the size, weight and cost of other system components. High breakdown voltage is a necessity in high efficiency switchmode amplifiers such as class C-E, which can see peak drain voltages of over 4X the applied V_{DD} .

Part Number	Pout (W)	Freq. (MHz)	VDD/BVDSS (V)	Rthjc (OC/W)	Package Style	Class of Operation
ARF449AG/BG	90	120	150/450	0.76	TO-247	A-E
ARF463AG/BG	100	100	125/500	0.70	TO-247	A-E
ARF463AP1G/BP1G	100	100	125/500	0.70	TO-247	A-E
ARF446G/ARF447G	140	65	250/900	0.55	TO-247	A-E
ARF521	150	150	165/500	0.60	M174	A-E
ARF460AG/BG	150	65	125/500	0.50	TO-247	A-E
ARF461AG/BG	150	65	250/1000	0.50	TO-247	A-E
ARF465AG/BG	150	60	300/1200	0.50	TO-247	A-E
ARF468AG/BG	270	45	165/500	0.38	TO-264	A-E
ARF475FL	300	150	165/500	0.31	T3A	A-E
ARF476FL	300	150	165/500	0.31	T3	A-E
ARF466AG/BG	300	45	200/1000	0.35	TO-264	A-E
ARF466FL	300	45	200/1000	0.13	T3A	A-E
ARF479	300	150	165/500	0.31	T3C	A-E
ARF469AG/BG	350	45	165/500	0.28	TO-264	A-E
ARF477FL	400	65	165/500	0.18	T3A	A-E
ARF1500	750	40	125/500	0.12	T1	A-E
ARF1501	750	40	250/1000	0.12	T1	A-E
ARF1510	750	40	700/1000	0.12	T1	D
ARF1511	750	40	380/500	0.12	T1	D
ARF1519	750	25	250/1000	0.13	T2	A-E

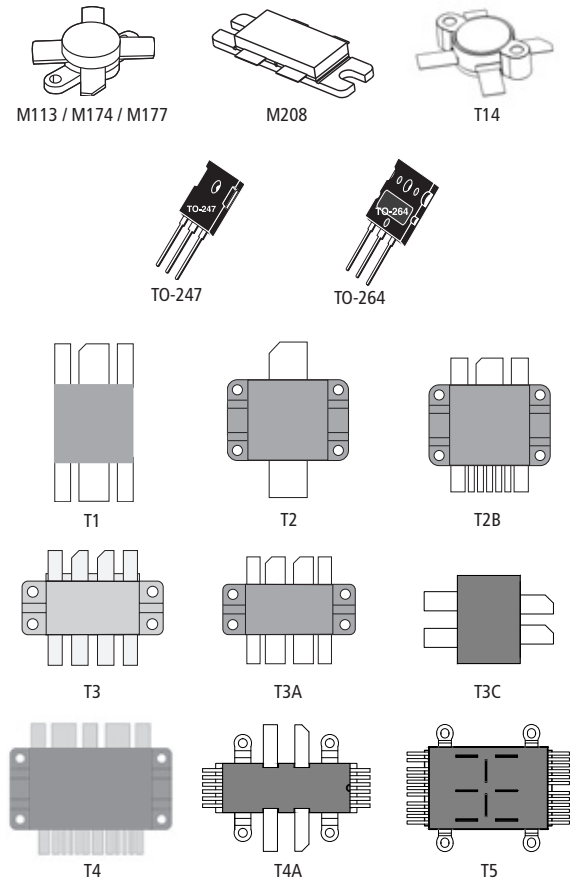

High Frequency RF MOSFETs

The VRF family of RF MOSFETs are improved replacements for industry standard RF transistors. They provide improved ruggedness by increasing the BV_{DSS} over 30% from the industry standard of 125 volts to 170V minimum. Low cost flangeless packages are another improvement that show Microsemi's dedication to optimizing performance, reducing cost and improving reliability. We will continue to offer a greater number of product offerings in the new reduced-cost flangeless packages.

Part Number	Pout (W)	Freq. (MHz)	Gain typ (dB)	Eff. Typ (%)	VDD/BVDSS (V)	Rthjc (OC/W)	Package Style
VRF148A	30	175	16	50	65/170	1.52	M113
VRF141	150	175	13	45	28/80	0.60	M174
VRF151	150	175	14	50	65/170	0.60	M174
VRF152	150	175	14	50	50/140	0.60	M174
VRF191	150	175	14	50	100/250	0.60	M174
VRF150	150	150	11	50	65/170	0.60	M174
VRF161	200	175	25	50	65/170	0.50	M177
VRF151G	300	175	16	55	65/170	0.30	M208
VRF2933	300	150	25	50	65/170	0.27	M177
VRF2933FL	300	150	25	50	65/170	0.27	T14
VRF3933	300	150	28	60	100/250	0.27	M177
VRF3933FL	300	150	28	60	100/250	0.27	T14
VRF2944	400	150	25	50	65/170	0.22	M177
VRF2944FL	400	150	25	50	65/170	0.22	T14
VRF154FL	600	30	17	45	65/170	0.13	T2
VRF157FL	600	30	21	45	65/170	0.13	T2
VRF164FL	600	30	21	45	65/170	0.10	T2

Drivers and Driver-RF MOSFET Hybrids

The DRF1200/01/02/03 Hybrids integrate Driver, bypass capacitors and RF MOSFETS into a single package. Integration maximizes amplifier performance by minimizing transmission line parasitics between the Driver and MOSFET. The DRF1300 or DRF1301 has two independent channels, each containing a Driver and RF MOSFET in a push pull configuration. The DRF1400A and B are half bridge hybrids with symmetrically orientated leads so that the two can easily be configured into a full bridge converter. All DRF parts feature a proprietary Anti-ring function to eliminate cross conduction in a Bridge or push-pull topologies. All DRF parts can be externally selected in either an inverting or non-inverting configuration.

Part Number	Pout (W)	Freq. (MHz)	VDD/BVDSS (V)	Package Style	Class of Operation
DRF1200	400	30	15/1000	T2B	D-E
DRF1201	600	30	15/1000	T2B	D-E
DRF1300	1000	30	15/500	T4	D-E
DRF1301	1000	30	15/1000	T4	D-E
DRF1400	1000	30	15/500	T4	D-E
DRF1211	600	30	15/500	T2B	D-E
DRF1410	1000	30	15/500	T4A	D-E
DRF1510	2000	30	15/500	T5	D-E

Reference Design Kits

DRF1200/CLASS-E, 13.56 MHz

DRF1200/CLASS-E, 27.12 MHz

The DRF1200/CLASS-E Single Ended RF Generator is a reference design providing the designer the ability to evaluate an 85% efficient 1000W CLASS-E RF Generator

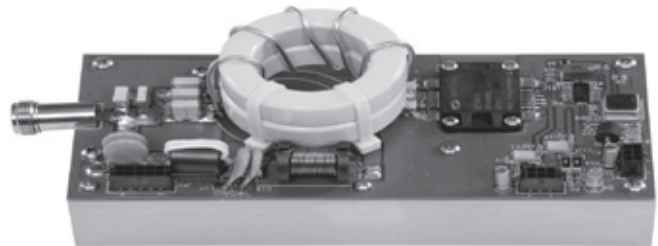

DRF1300/CLASS-D, 13.56 MHz

The DRF1300/CLASS-D Push Pull RF Generator is a reference design providing the designer the ability to evaluate an 80% efficient 2000W CLASS-D RF Generator

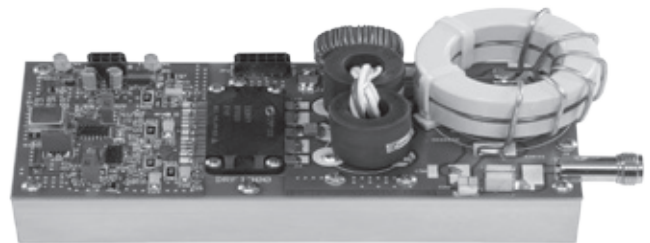

DRF1400/CLASS-D, 13.56 MHz

The DRF1400/CLASS-D Half Bridge RF Generator is a reference design providing the designer the ability to evaluate an 85% efficient 2500W CLASS-D RF Generator

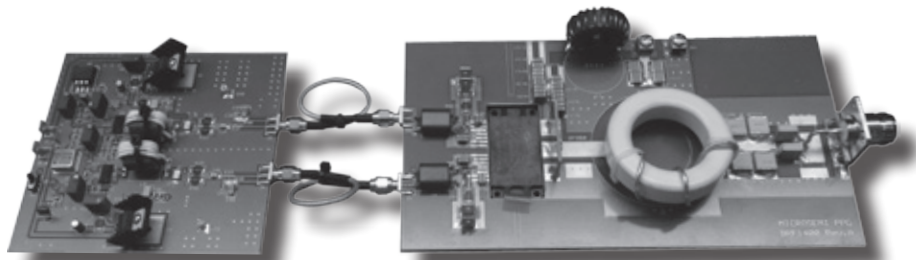

All kits include: A fully populated board attached to an aluminum heat sink. An extensive application note explaining the theory of operation with designer's recommendations for evaluation and board layout. All key waveforms are illustrated and described. A complete parts list with recommended vendor part numbers and the board's Gerber file are provided for an easy transition into an end application.

New DRF1410 and DRF1510 Reference Designs Coming Soon

Power Modules Contents

IGBT Power Modules

POWER MODULE INFORMATION	17-21
CHOPPER AND PHASE LEG	22
3 PHASE BRIDGE	23
TRIPLE PHASE LEG	23
TRIPLE DUAL COMMON SOURCE	23
DUAL CHOPPER	23
FULL & ASYMMETRICAL BRIDGE	24
SINGLE SWITCH	25
SINGLE SWITCH + SERIES DIODE	25
DUAL COMMON SOURCE	25

Intelligent Power Modules

PHASE LEG	25
-----------	----

MOSFET Power Modules

BOOST and BUCK CHOPPER	26
DUAL CHOPPER	26
FULL BRIDGE	27
FULL BRIDGE + SERIES AND PARALLEL DIODES	27
ASYMMETRICAL BRIDGE	27
PHASE LEG	28
PHASE LEG + SERIES AND PARALLEL DIODES	28
PHASE LEG + SERIES DIODES	28
TRIPLE PHASE LEG	28
TRIPLE DUAL COMMON SOURCE	29
DUAL COMMON SOURCE	29
SINGLE SWITCH	29
SINGLE SWITCH + SERIES DIODE	29
SINGLE SWITCH + SERIES AND PARALLEL DIODES	29
INTERLEAVED PFC	29
SINGLE AND DUAL LINEAR MOSFET	30

RENEWABLE ENERGY Power Modules

FULL BRIDGE	30
PFC + BYPASS DIODE + PHASE LEG	30
PFC + FULL BRIDGE	30
PFC + BYPASS DIODE + FULL BRIDGE	30
SECONDARY FAST RECTIFIER + FULL BRIDGE	30
BOOST BUCK	31
3-LEVEL NPC INVERTER	31
T-TYPE 3-LEVEL INVERTER	31

SiC Diode Power Modules

DUAL DIODE	32
FULL BRIDGE	32

IGBT + SiC Diode Power Modules

BOOST CHOPPER	32
DUAL CHOPPER	32

MOSFET + SiC Diode Power Modules

SINGLE SWITCH + SERIES FRED AND SiC PARALLEL DIODES	33
CHOPPER	33
PHASE LEG + SERIES FRED AND SiC PARALLEL DIODES	33
FULL BRIDGE + SERIES FRED AND SiC PARALLEL DIODES	33
TRIPLE PHASE LEG	33

SiC MOSFET Power Modules

T-TYPE 3-LEVEL INVERTER	34
3-LEVEL NPC INVERTER	34
PHASE LEG	34
TRIPLE PHASE LEG	34
BOOST CHOPPER	34
BUCK CHOPPER	34
FULL BRIDGE	34

Diode Power Modules

SINGLE DIODE	35
3-PHASE BRIDGE	35
FULL BRIDGE	35
COMMON CATHODE - COMMON ANODE - DOUBLER	35

Package Outlines Drawings	36-39
---------------------------	-------

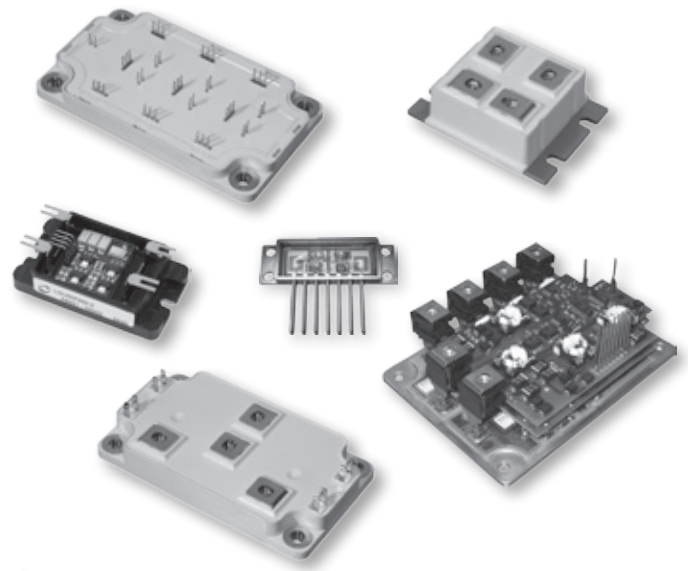

Microsemi combines a formidable array of technologies in semiconductors, packaging and automated manufacturing to produce a wide range of high quality modules optimized for:

- Reliability
- Efficiency and electrical performance
- Low cost
- Space savings
- Reduced assembly time

The readily available standard module product line spans a wide selection of circuit topologies, semiconductors including Silicon Carbide, voltage and current ratings and packages. If you need even more flexibility or intellectual property protection, Microsemi can often customize a standard module with low set up cost and with a short lead time. Unique requirements can be met with Application Specific Power Modules (ASPM®).

Microsemi serves a broad spectrum of industrial applications for Welding, Solar, Induction Heating, Medical, UPS, Motor Control and SMPS markets as well as HI-REL applications for Semicap, Defense and Aerospace markets. A wide selection of construction materials enables Microsemi to manufacture with short lead times modules that feature:

- Extended temperature range: -60°C to +200°C
- High reliability
- Reduced size and weight
- Hi-Rel testing and screening options

Microsemi's experience and expertise in power electronic conversion brings the most effective technical support for your new development.

- Isolated gate driver
- Snubbers
- Mix & match semiconductors
- Short circuit protection
- Temperature & current sensing
- Parameter binning

Standard Electrical Configurations

Microsemi offers a wide range of standard electrical configurations housed in a variety of packages to match your specific need for high power density and performance. Various semiconductor types are offered in the same topology.

Electrical Topology	IGBT 600V to 1700V	MOSFET 75V to 1200V	Diode 200V to 1700V	Mix Si-SiC 600 & 1200V	Full SiC 600 to 1700V
Asymmetrical Bridge	X	X			
Boost Buck	X	X			
Boost & Buck Chopper	X	X		X	X
Common Anode			X		
Common Cathode			X		
Dual Boost & Buck Chopper	X	X		X	
Dual Common Source	X	X			
Dual Diode					X
Full Bridge	X	X	X		X
Full Bridge + PFC	X	X		X	
Full Bridge + Secondary Fast Rectifier Bridge	X	X		X	
Full Bridge + Series and Parallel Diodes		X		X	
Interleaved PFC	X	X			
Linear single and Dual switch		X			
Phase Leg	X	X	X		X
Phase Leg Intelligent	X				
Phase Leg + PFC		X		X	
Phase Leg + Series and Parallel Diodes		X		X	
Single Switch	X	X	X		
Single Switch + Series and Parallel Diodes		X		X	
Single Switch + Series Diodes	X	X			
3-Level NPC Inverter	X				X
3-Level T-Type Inverter	X			X	X
3-Phase Bridge	X		X		
Triple Dual Common Source	X	X			
Triple Phase Leg	X	X		X	X

Trench3
Trench4
Trench4 Fast
Trench5

MOSFET
FREDFET
CoolMOS

FRED
Std Rectifier

IGBT
MOSFET
Diode

Diode
MOSFET

Packaging

Improved Low Profile Packages

SP1 (12mm)
SP3F (12mm)
SP4 (17mm)
SP6 (17mm)
SP6-P (12mm)



Industry Standard Packages

SOT-227 (Isotop®)
SP2 (17mm)
 34mm & 62mm Types
 D1 (34 mm Wide)
 D3 (62 mm Wide)
 D4 (62 mm Wide)



Package Advantages

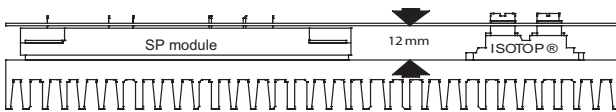

SP1 package:

- Replaces 2 SOT-227 parts
- Improved assembly time and cost
- Height compatible with SOT-227
- Copper base plate



SP3F package:

- Replaces up to 4 SOT-227 parts
- Reduced assembly time and cost
- Height compatible with SOT-227
- Copper base plate



30 mm



17 mm

SP6 package:

- Offers the same footprint and the same pinout location as the popular 62mm package but with lower height, leading to:
 - Reduced stray inductance
 - Reduced parasitic resistance
 - Higher efficiency at high frequency



SP6-P package:

- Replaces up to 6 SOT-227 parts
- Height compatible with SOT-227
- Low inductance solder pins
- High current capability

Custom Power Modules

Microsemi PMP has created the Application Specific Power Module (ASPM) concept and has been offering customized power modules since 1983. Microsemi PMP offers a complete engineered solution with mix and match capabilities in term of package, configuration, performance and cost.

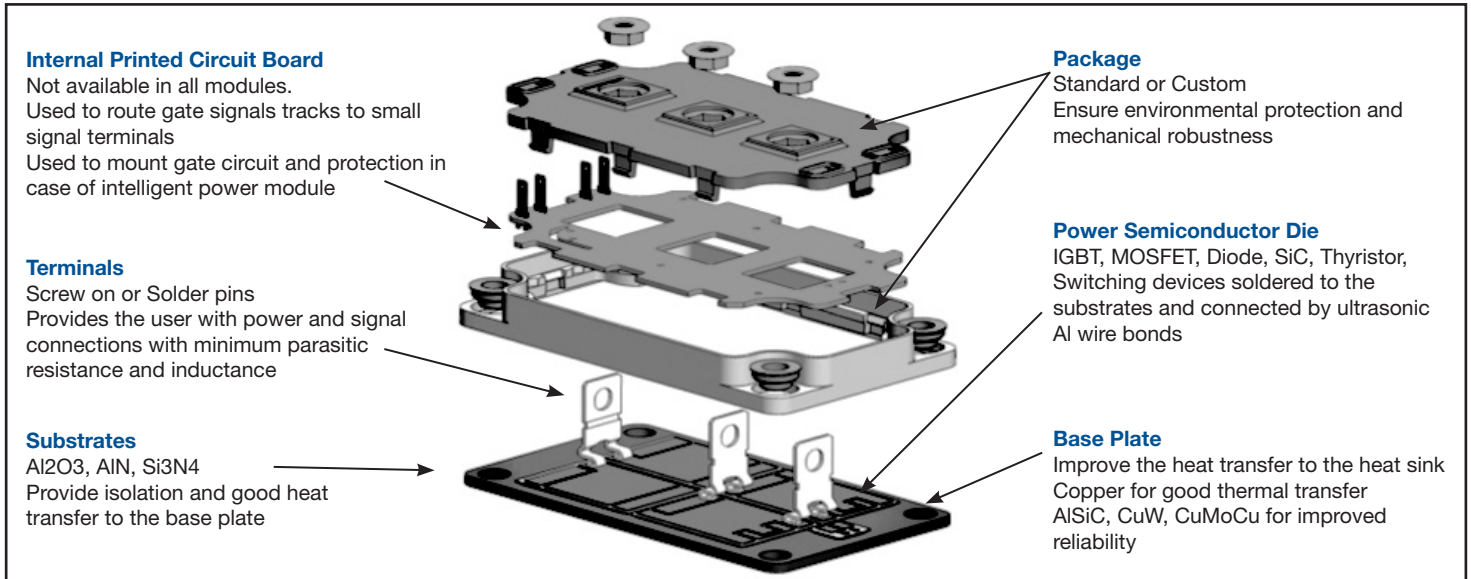

3 levels of customization are proposed offering different cost and low volume entry:

Change Options:	Die	Substrate	Base plate	Plastic lid	Terminals	NRE level	MOQ
Elect./thermal performance	Die P/N	Material	Material	-	-	None to low	5 to 10 pieces
Elect./thermal performance + electrical configuration	Die P/N	Material & Layout	Material	-	-	Low to medium	
Elect./thermal performance + electrical configuration + module housing	Die P/N	Material & Layout	Material & Shape	Material & Shape	Shape	Medium to high	

Microsemi PMP power modules are made of different sub-elements. Most of them are standard and can be re-used to build infinite solutions for the end user.

Microsemi PMP offers optimum development cost and cycle time thanks to long term experience and wide range of available technologies.

Power Modules Features

High Power Density

Isolated and highly thermally conductive substrate

Internal wiring

Minimum parasitics

Minimum output terminals

Mix & match components

Full engineered solutions

Customer Benefits

Size and cost reduction

Excellent thermal management

Reduced external hardware

Improved performance

Reduced assembly time

Optimizes losses

Easy upgrade/less parts counts/short time to market/IP protection

FLEXIBILITY

Great level of integration
Mix of Silicon within the same package
No quantity limitation

PACKAGING CAPABILITY

Standard and custom packages
Standard and custom terminals
Various substrate technologies

TECHNOLOGY

Application oriented

RELIABILITY

Coefficient of thermal expansion matching

APPLICATIONS

Solar - Welding - Plasma Cutting - Semicap - MRI & X-Ray - EV/HEV - Induction Heating - UPS - Motor control - Data Communication

Rugged Custom Power Modules

Microsemi PMP has acquired a great experience and know-how in module customization to address rugged and wide temperature range application and offers solution to meet with next generation integrated power systems expectation in terms of:

- Improved Reliability
- Wider Operating Temperatures
- Higher Power
- Higher Efficiency
- Lower Weight and Size
- Lower Cost

Applications

- Avionics actuation system
- Avionics lift and pump
- Military ground vehicle
- power supply and motor control
- Navy ship auxiliary power supply
- Down hole drilling

Test Capabilities

- X-Ray inspection
- Dielectric test (up to 6KV)
- Electrical testing at specified temperature
- Burn-in
- Acoustic imaging

Reliability Testing Capabilities

- Power cycling
- Hermetic sealing
- Moisture
- Salt atmosphere
- HTGB
- Temperature shock
- HAST
- H3TRB
- Altitude
- Mechanical shock, vibration

Expertise Capabilities

- Cross-sectioning
- Structural analysis

All tests can be conducted upon demand by sampling or at 100%. Tests performed in house or with external lab.

Our Core Competencies

- Extensive experience of rugged solutions for harsh environments
- Wide range of Silicon technologies
- Wafer fab capabilities
- Mix of assembly technologies
- Hermetic and robust plastic packages
- Custom test & burn-in solutions
- ISO9001 certified
- End-of-life (obsolescence) management
- Thermal management
- Material expertise
- Product life management associated to risks analysis

Various solutions are proposed offering different cost and low volume of entry:

	Industrial Application	Extended Temperature Application	Harsh Environment Application	
Standard Module	X			No NRE Low Volume Entry
Modified Standard	X	X		Low NRE Low Volume Entry
Custom Module	X	X	X	Medium to High NRE Low Volume Entry

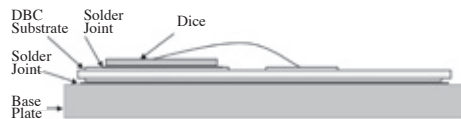

	CTE (ppm/K)	Thermal conductivity (W/m.K)	Rthjc (K/W)
Silicon Die (120 mm2)	4	136	
Cu/Al ₂ O ₃	17/7	390/25	0.35
AlSiC/Al ₂ O ₃	7/7	170/25	0.38
Cu/AlN	17/5	390/170	0.28
AlSiC/AlN	7/5	170/170	0.31
AlSiC/Si ₃ N ₄	7/3	170/60	0.31

	Material	CTE (ppm/K)	Thermal conductivity (W/m.K)	Density (g/cc)
Base plate	CuW	6.5	190	17
	AlSiC	7	170	2.9
	Cu	17	390	8.9
Substrate	Al ₂ O ₃	7	25	-
	AlN	5	170	-
	Si ₃ N ₄	3	60	-
Die	Si	4	136	-
	SiC	2.6	270	-

Module performance and reliability depends on the choice of the assembly materials

More closely matched materials TCE's increase the module life time because it will result in much less stress at the interface of the materials and inside the materials.

The higher the thermal conductivity, the lower is the junction to case thermal resistance and the lower will be the delta of junction temperature of the device during operation such that the effect of power cycling on the dice will be minimized.

Another important feature is the material density particularly for the baseplate. Taking copper as the reference, AlSiC has a density of 1/3 while CuW has twice the density. Therefore AlSiC will provide substantial weight reduction at the same time as reliability increase.



Power Module Part Numbering System

IGBT Modules

APT	GL	475	A	120	T	D3	G
I	II	III	IV	V	VI	VII	VIII

I Trade Mark

II **IGBT Type:**
GL = TRENCH 4
GLQ = High speed Trench 4
GT = TRENCH 3
GTQ = TRENCH 5
GV = Mix NPT/TRENCH
CV = Mix TRENCH/CoolMOS

III **Current:**
Ic @ Tc=80°C

IV **Topology:**
A = Phase Leg
BB = Boost Buck
DA = Boost Chopper
DDA = Double Boost Chopper
DH = Asymmetrical Bridge
DSK = Double Buck Chopper
DU = Dual Common Source
H = Full Bridge
HR = T-Type 3-Level
SDA = Double Boost + Bypass Diode
SK = Buck Chopper
TA = Triple Phase Leg
TDU = Triple Dual Common Source
TL = Three Level
U = Single Switch
VDA = Interleaved PFC
X = Three Phase Bridge

V **Blocking Voltage:**
60 = 600V
120 = 1200V
170 = 1700V

VI **Option:**
A = AlN Substrate
C = SiC Diode
D = Series Diode
T = Temperature Sensor
W = Clamping Parallel Diode

VII **Package:**
1 = SP1
2 = SP2
3 = SP3F
P = SP6-P
D3 = D3 (62mm)
D4 = D4 (62mm)

VIII **G** = RoHS Compliant

MOSFET Modules

APT	C	60	DA	M24	T	1	G
I	II	III	IV	V	VI	VII	VIII

I Trade Mark

II **MOSFET Type:**
MC - SM = MOSFET SiC
M = MOSFET
C = CoolMOS

III **Blocking Voltage:**
08 = 75V **80** = 800V
10 = 100V **90** = 900V
20 = 200V **100** = 100V
50 = 500V **120** = 120V
60 = 600V

IV **Topology:**
A = Phase Leg
BB = Boost Buck
DA = Boost Chopper
DDA = Double Boost Chopper
DH = Asymmetrical Bridge
DSK = Double Buck Chopper
DU = Dual Common Source
H = Full Bridge
HR = T-Type 3-Level
SDA = Double Boost + Bypass Diode
SK = Buck Chopper
TA = Triple Phase Leg
TDU = Triple Dual Common Source
TL = Three Level NPC
U = Single Switch
VDA = Interleaved PFC

V **RDSON @ Tc=25°C**
240 = 2400mΩ
24 = 240mΩ
M24 = 24mΩ

VI **Option:**
A = AlN Substrate
C = SiC Diode
D = Series Diode
F = FREDFET
S = Series and Parallel Diodes
T = Temperature Sensor
U = Ultrafast FREDFET

VII **Package:**
1 = SP1
2 = SP2
3 = SP3F
P = SP6-P

VIII **G** = RoHS Compliant

Diode Modules

APT	DR	90	X	160	1	G
I	II	III	IV	V	VI	VII

I Trade Mark

II **Diode Type:**
DF = FRED
DR = Standard Rectifier
DC = SiC
DSK = Schottky

III **Current:**
IF @ Tc=80°C

IV **Topology:**
AA = Dual Common Anode
BB = Boost Buck
AK = Dual Series
KK = Dual Common Cathode
H = Single Phase Bridge
U = Single Switch
X = Three Phase Bridge

V **Blocking Voltage:**
20 = 200V
40 = 400V
60 = 600V
100 = 1000V
120 = 1200V
160 = 1600V
170 = 1700V

VI **Package:**
1 = SP1
3 = SP3F

VII **G** = RoHS Compliant

Optional Materials

Optional materials are available upon demand on most of the listed standard power modules. Options are indicated with a letter in the suffix of the module part number. Temperature Sensor Option is indicated in the catalog with "YES" or "option" when available on standard part or on demand.

- A** AlN Substrate for higher thermal conductivity
- M** AlSiC Base plate material for improved temperature cycling capabilities
- T** Temperature Sensor (NTC or PTC) for Case Temperature information
- C** SiC Diode for higher efficiency
- N** Si3N4 Substrate
- E** Press fit terminals (for SP3F package only)

IGBT Power Modules

CHOPPER AND PHASE LEG

V_{CES} (V)	IGBT Type	I_c (A) $T_c=80^\circ\text{C}$	$V_{CE(on)}$ (V) at rated I_c	Package	NTC			
600	TRENCH3	75	1.5	SP1	YES	APTGT75DA60T1G	APTGT75SK60T1G	APTGT75A60T1G
		100	1.5	SP1	YES	APTGT100DA60T1G	APTGT100SK60T1G	APTGT100A60T1G
		100	1.5	SP2	-	N/A	N/A	APTGT100A602G
		150	1.5	SP1	YES	APTGT150DA60T1G	APTGT150SK60T1G	APTGT150A60T1G
		150	1.5	SP3F	YES	N/A	N/A	APTGT150A60T3AG
		200	1.5	SP2	-	N/A	N/A	APTGT200A602G
		200	1.5	SP3F	YES	APTGT200DA60T3AG	APTGT200SK60T3AG	APTGT200A60T3AG
		300	1.5	SP4	YES	N/A	N/A	APTGT300A60TG
		300	1.5	SP6	option	APTGT300DA60G	APTGT300SK60G	APTGT300A60G
		300	1.5	D3	option	APTGT300DA60D3G	APTGT300SK60D3G	APTGT300A60D3G
		400	1.5	D3	option	APTGT400DA60D3G	APTGT400SK60D3G	APTGT400A60D3G
		450	1.5	SP6	option	APTGT450DA60G	APTGT450SK60G	APTGT450A60G
		600	1.5	SP6	option	APTGT600DA60G	APTGT600SK60G	APTGT600A60G
650	TRENCH 4 FAST	100	1.85	SP1	YES	N/A	N/A	APTGLQ100A65T1G
		600	1.85	SP6	YES	N/A	N/A	APTGLQ600A65T6G
650	TRENCH 5	60	1.65	SP1	YES	APTGTQ100DA65T1G	APTGTQ100SK65T1G	APTGTQ100A65T1G
		120	1.65	SP3F	YES	APTGTQ200DA65T3G	APTGTQ200SK65T3G	APTGTQ200A65T3G
1200	TRENCH 3	35	1.7	SP1	YES	N/A	N/A	APTGT35A120T1G
		35	1.7	SOT227	-	APT35GT120JU2	APT35GT120JU3	N/A
		50	1.7	SOT227	-	APT50GT120JU2	APT50GT120JU3	N/A
		50	1.7	SP1	YES	N/A	N/A	APTGT50A120T1G
		50	1.7	SP2	-	N/A	N/A	APTGT50A120T2G
		50	1.7	SP4	YES	APTGT50DA120TG	APTGT50SK120TG	N/A
		75	1.7	SOT227	-	APT75GT120JU2	APT75GT120JU3	N/A
		75	1.7	SP1	YES	N/A	N/A	APTGT75A120T1G
		75	1.7	SP2	-	N/A	N/A	APTGT75A120T2G
		75	1.7	SP4	YES	APTGT75DA120TG	APTGT75SK120TG	N/A
		100	1.7	SP1	YES	APTGT100DA120T1G	N/A	N/A
		100	1.7	SOT227	-	APT100GT120JU2	APT100GT120JU3	N/A
		100	1.7	SP2	-	N/A	N/A	APTGT100A120T2G
		100	1.7	SP3F	YES	N/A	N/A	APTGT100A120T3AG
		100	1.7	SP4	YES	N/A	N/A	APTGT100A120TG
		150	1.7	SP6	option	APTGT150DA120G	APTGT150SK120G	APTGT150A120G
		150	1.7	SP3F	YES	N/A	N/A	APTGT150A120T3AG
		150	1.7	SP4	YES	N/A	N/A	APTGT150A120TG
		200	1.7	SP6	option	APTGT200DA120G	APTGT200SK120G	APTGT200A120G
		200	1.7	D3	option	APTGT200DA120D3G	APTGT200SK120D3G	APTGT200A120D3G
		300	1.7	SP6	option	APTGT300DA120G	APTGT300SK120G	APTGT300A120G
		300	1.7	D3	option	APTGT300DA120D3G	APTGT300SK120D3G	APTGT300A120D3G
		400	1.7	SP6	option	APTGT400DA120G	APTGT400SK120G	APTGT400A120G
		400	1.7	D3	option	N/A	N/A	APTGT400A120D3G
1200	TRENCH 4	40	1.85	SOT227	-	APT40GL120JU2	APT40GL120JU3	N/A
		90	1.85	SP1	YES	APTGL90DA120T1G	APTGL90SK120T1G	APTGL90A120T1G
		180	1.85	SP2	-	N/A	N/A	APTGL180A120T2G
		180	1.85	SP3F	YES	N/A	N/A	APTGL180A120T3AG
		325	1.85	D3	option	APTGL325DA120D3G	APTGL325SK120D3G	APTGL325A120D3G
		475	1.85	D3	option	APTGL475DA120D3G	APTGL475SK120D3G	APTGL475A120D3G
		700	1.85	D3	option	APTGL700DA120D3G	APTGL700SK120D3G	N/A
	TRENCH 4 FAST	100	2.05	SP3F	YES	N/A	N/A	APTGLQ100A120T3AG
400	2.05	SP6	YES	N/A	N/A	APTGLQ400A120T6G		
1700	TRENCH 3	30	2.0	SP1	YES	APTGT30DA170T1G	APTGT30SK170T1G	APTGT30A170T1G
		50	2.0	SP1	YES	APTGT50DA170T1G	APTGT50SK170T1G	APTGT50A170T1G
		50	2.0	SP4	YES	APTGT50DA170TG	APTGT50SK170TG	APTGT50A170TG
		75	2.0	SP1	YES	APTGT75DA170T1G	N/A	N/A
		100	2.0	SP4	YES	APTGT100DA170TG	APTGT100SK170TG	APTGT100A170TG
		150	2.0	SP6	option	APTGT150DA170G	APTGT150SK170G	APTGT150A170G
		200	2.0	D3	option	APTGT200DA170D3G	APTGT200SK170D3G	APTGT200A170D3G
		225	2.0	SP6	option	APTGT225DA170G	APTGT225SK170G	APTGT225A170G
		300	2.0	SP6	option	APTGT300DA170G	APTGT300SK170G	APTGT300A170G
300	2.0	D3	option	APTGT300DA170D3G	APTGT300SK170D3G	APTGT300A170D3G		

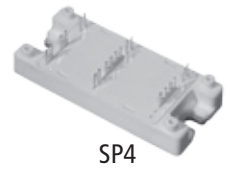
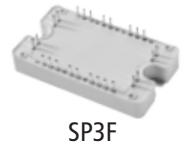

NEW!
NEW!

IGBT Power Modules

3 PHASE BRIDGE

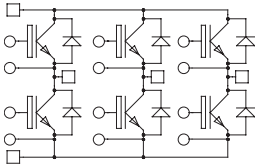

V_{CES} (V)	IGBT Type	I_c (A) $T_c=80^\circ\text{C}$	$V_{CE(on)}$ (V) at rated I_c	Package	NTC	Part Number
600	TRENCH 3	30	1.5	SP3F	YES	APTGT30X60T3G
		50	1.5	SP3F	YES	APTGT50X60T3G
		75	1.5	SP3F	YES	APTGT75X60T3G
1200	TRENCH 3	25	1.7	SP3F	YES	APTGT25X120T3G
		35	1.7	SP3F	YES	APTGT35X120T3G
	TRENCH 4	40	1.85	SP3F	YES	APTGL40X120T3G



SP3F

TRIPLE PHASE LEG

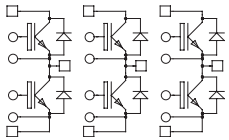

V_{CES} (V)	IGBT Type	I_c (A) $T_c=80^\circ\text{C}$	$V_{CE(on)}$ (V) at rated I_c	Package	NTC	Part Number
600	TRENCH 3	50	1.5	SP6-P	option	APTGT50TA60PG
		75	1.5	SP6-P	option	APTGT75TA60PG
		150	1.5	SP6-P	option	APTGT150TA60PG
650	TRENCH 5	30	1.65	SP3F	YES	APTGTQ50TA65T3G
		90	1.65	SP6P	YES	APTGTQ150TA65TPG
1200	TRENCH 3	75	1.7	SP6-P	option	APTGT75TA120PG
		100	1.7	SP6-P	YES	APTGT100TA120TPG
	TRENCH 4	120	1.85	SP6-P	YES	APTGL120TA120TPG

NEW!
NEW!



SP4

TRIPLE DUAL COMMON SOURCE

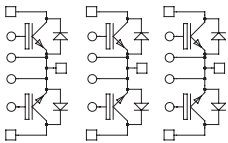

V_{CES} (V)	IGBT Type	I_c (A) $T_c=80^\circ\text{C}$	$V_{CE(on)}$ (V) at rated I_c	Package	NTC	Part Number
600	TRENCH 3	50	1.5	SP6-P	option	APTGT50TDU60PG
		75	1.5	SP6-P	option	APTGT75TDU60PG
		100	1.5	SP6-P	option	APTGT100TDU60PG
		150	1.5	SP6-P	option	APTGT150TDU60PG
1200	TRENCH 3	75	1.7	SP6-P	option	APTGT75TDU120PG
	TRENCH 4	120	1.85	SP6-P	YES	APTGL120TDU120TPG
1700	TRENCH 3	50	2.0	SP6-P	option	APTGT50TDU170PG



SP6-P

DUAL CHOPPER

V_{CES} (V)	IGBT Type	I_c (A) $T_c=80^\circ\text{C}$	$V_{CE(on)}$ (V) at rated I_c	Package	NTC	...DDA...	...DSK...
600	TRENCH 3	50	1.5	SP3F	YES	APTGT50DDA60T3G	APTGT50DSK60T3G
		75	1.5	SP3F	YES	APTGT75DDA60T3G	APTGT75DSK60T3G
650	TRENCH 5	60	1.65	SP3F	YES	APTGTQ100DDA65T3G	N/A
1200	TRENCH 3	50	1.7	SP3F	YES	APTGT50DDA120T3G	APTGT50DSK120T3G
		60	1.85	SP3F	YES	APTGL60DDA120T3G	APTGL60DSK120T3G
	TRENCH 4	90	1.85	SP3F	YES	APTGL90DDA120T3G	APTGL90DSK120T3G

NEW!

IGBT Power Modules

FULL & ASYMMETRICAL BRIDGE

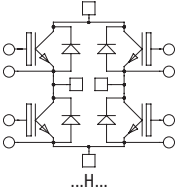
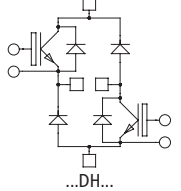
V_{CES} (V)	IGBT Type	I_c (A) $T_c=80^\circ\text{C}$	$V_{CE(on)}$ (V) at rated I_c	Package	NTC			
600	TRENCH 3	20	1.5	SP1	YES	APTGT20H60T1G	N/A	
		30	1.5	SP1	YES	APTGT30H60T1G	N/A	
		50	1.5	SP1	YES	APTGT50H60T1G	APTGT50DH60T1G	
		50	1.5	SP2	YES	APTGT50H60T2G	N/A	
		50	1.5	SP3F	YES	APTGT50H60T3G	N/A	
		75	1.5	SP1	YES	APTGT75H60T1G	APTGT75DH60T1G	
		75	1.5	SP2	YES	APTGT75H60T2G	N/A	
		75	1.5	SP3F	YES	APTGT75H60T3G	N/A	
		100	1.5	SP4	YES	APTGT100H60TG	APTGT100DH60TG	
		100	1.5	SP3F	YES	APTGT100H60T3G	APTGT100DH60T3G	
		150	1.5	SP4	YES	APTGT150H60TG	APTGT150DH60TG	
		200	1.5	SP6	-	APTGT200H60G	APTGT200DH60G	
		300	1.5	SP6	-	APTGT300H60G	APTGT300DH60G	
650	TRENCH 4 FAST	75	1.85	SP1	YES	APTGLQ75H65T1G	N/A	
		300	1.85	SP6	option	APTGLQ300H65G	N/A	
650	TRENCH 5	60	1.65	SP3F	YES	APTGTQ100H65T3G	N/A	
1200	TRENCH 3	35	1.7	SP3F	YES	APTGT35H120T3G	N/A	
		50	1.7	SP3F	YES	APTGT50H120T3G	APTGT50DH120T3G	
		50	1.7	SP4	YES	APTGT50H120TG	APTGT50DH120TG	
		75	1.7	SP3F	YES	N/A	APTGT75DH120T3G	
		75	1.7	SP4	YES	APTGT75H120TG	APTGT75DH120TG	
		100	1.7	SP4	YES	N/A	APTGT100DH120TG	
		100	1.7	SP6	-	APTGT100H120G	N/A	
		150	1.7	SP6	-	APTGT150H120G	APTGT150DH120G	
		200	1.7	SP6	-	APTGT200H120G	APTGT200DH120G	
	TRENCH 4	40	1.85	SP1	YES	APTGL40H120T1G	N/A	
		60	1.85	SP3F	YES	APTGL60H120T3G	APTGL60DH120T3G	
		90	1.85	SP3F	YES	APTGL90H120T3G	APTGL90DH120T3G	
	TRENCH 4 FAST	40	2.05	SP1	YES	APTGLQ40H120T1G	N/A	
		75	2.05	SP3F	YES	APTGLQ75H120T3G	N/A	
		200	2.05	SP6	option	APTGLQ200H120G	N/A	
	1700	TRENCH 3	30	2.0	SP3F	YES	APTGT30H170T3G	N/A
			50	2.0	SP4	YES	APTGT50H170TG	APTGT50DH170TG
100			2.0	SP6	-	APTGT100H170G	APTGT100DH170G	
150			2.0	SP6	-	APTGT150H170G	APTGT150DH170G	

NEW!



SP1

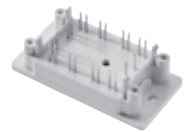

SP2



SP3F



SP4



SP6 Full Bridge

IGBT Power Modules

SINGLE SWITCH

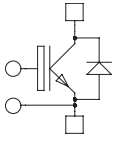

V_{CES} (V)	IGBT Type	I_c (A) $T_c=80^\circ\text{C}$	$V_{CE(on)}$ (V) at rated I_c	Package	NTC	Part Number
600	TRENCH 3	750	1.5	D4	-	APTGT750U60D4G
1200	TRENCH 3	400	1.7	D4	-	APTGT400U120D4G
		600	1.7	D4	-	APTGT600U120D4G
	TRENCH 4	475	1.85	D4	-	APTGL475U120D4G
		700	1.85	D4	-	APTGL700U120D4G
1700	TRENCH 3	400	2.0	D4	-	APTGT400U170D4G
		600	2.0	D4	-	APTGT600U170D4G



D4

SINGLE SWITCH + SERIES DIODE

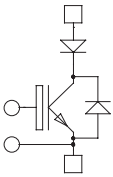

V_{CES} (V)	IGBT Type	I_c (A) $T_c=80^\circ\text{C}$	$V_{CE(on)}$ (V) at rated I_c	Package	NTC	Part Number
1200	TRENCH 4	475	1.85	SP6	-	APTGL475U120DAG



SP4

DUAL COMMON SOURCE

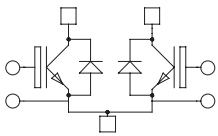

V_{CES} (V)	IGBT Type	I_c (A) $T_c=80^\circ\text{C}$	$V_{CE(on)}$ (V) at rated I_c	Package	NTC	Part Number
600	TRENCH 3	100	1.5	SP4	YES	APTGT100DU60TG
		200	1.5	SP4	YES	APTGT200DU60TG
		300	1.4	SP6	-	APTGT300DU60G
		600	1.4	SP6	-	APTGT600DU60G
1200	TRENCH 3	50	1.7	SP4	YES	APTGT50DU120TG
		75	1.7	SP4	YES	APTGT75DU120TG
		100	1.7	SP4	YES	APTGT100DU120TG
		150	1.7	SP6	-	APTGT150DU120G
		150	1.7	SP4	YES	APTGT150DU120TG
		200	1.7	SP6	-	APTGT200DU120G
		300	1.7	SP6	-	APTGT300DU120G
		400	1.7	SP6	-	APTGT400DU120G
1700	TRENCH 3	100	2.0	SP4	YES	APTGT100DU170TG
		225	2.0	SP6	-	APTGT225DU170G
		300	2.0	SP6	-	APTGT300DU170G

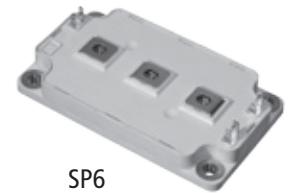

SP6

Intelligent Power Modules

PHASE LEG

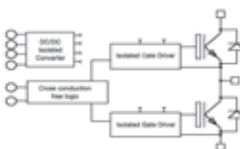

V_{CES} (V)	IGBT Type	I_c (A) $T_c=80^\circ\text{C}$	$V_{CE(on)}$ (V) at rated I_c	Package	NTC	Part Number
600	TRENCH 3	400	1.5	LP8	-	APTLGT400A608G
1200	TRENCH 3	300	1.7	LP8	-	APTLGT300A1208G
	TRENCH 4	325	1.8	LP8	-	APTLGL325A1208G



LP8

MOSFET Power Modules

CHOPPER

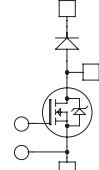
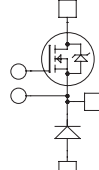
V_{DS} (V)	MOSFET Type	$R_{DS(ON)}$ (m Ω)	I_b (A) $T_c=80^\circ\text{C}$	Package	NTC	 DA...or...U2	 SK...or...U3
100	MOS 5	11	100	SOT-227	-	APT10M11JVU2	APT10M11JVU3
		4.5	207	SP4	YES	APT10DAM05TG	APT10SKM05TG
		2.25	370	SP6	-	APT10DAM02G	APT10SKM02G
200	MOS 5	22	71	SOT-227	-	APT20M22JVU2	APT20M22JVU3
		8	147	SP4	YES	APT20DAM08TG	APT20SKM08TG
	MOS 7	5	250	SP6	option	APT20DAM05G	APT20SKM05G
		4	300	SP6	option	APT20DAM04G	APT20SKM04G
500	MOS 5	100	30	SOT-227	-	APT5010JVU2	APT5010JVU3
		100	30	SOT-227	-	APT5010JLU2	APT5010JLU3
	MOS 7	75	32	SOT-227	-	APT50M75JLU2	APT50M75JLU3
		19	125	SP6	option	APT50DAM19G	APT50SKM19G
		17	140	SP6	option	APT50DAM17G	APT50SKM17G
MOS 8	65	43	SOT-227	-	APT58M50JU2	APT58M50JU3	
	70	40	SOT-227	-	APT40N60JCU2	APT40N60JCU3	
600	CoolMOS	24	70	SP1	YES	APTC60DAM24T1G	APTC60SKM24T1G
900	CoolMOS	120	25	SOT-227	-	APT33N90JCU2	APT33N90JCU3
		60	44	SP1	YES	APTC90DAM60T1G	APTC90SKM60T1G
1000	MOS 7	180	33	SP4	YES	APT100DA18TG	APT100SK18TG
		90	59	SP6	option	APT100DAM90G	APT100SKM90G
	MOS 8	330	17	SP1	YES	APT100DA33T1G	APT100SK33T1G
1200	MOS8	300	23	SP1	YES	APT120DA30T1G	N/A

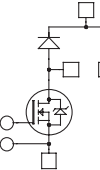
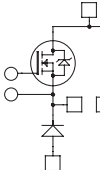

DUAL CHOPPER

V_{DS} (V)	MOSFET Type	$R_{DS(ON)}$ (m Ω)	I_b (A) $T_c=80^\circ\text{C}$	Package	NTC	 ...DDA...	 ...DSK...
100	MOS 5	19	50	SP3F	YES	APT10DDAM19T3G	APT10DSKM19T3G
		9	100	SP3F	YES	APT10DDAM09T3G	APT10DSKM09T3G
500	MOS 7	100	24	SP3F	YES	APT50DDA10T3G	APT50DSK10T3G
		65	37	SP3F	YES	APT50DDAM65T3G	APT50DSKM65T3G
		45	38	SP1	YES	APTC60DDAM45T1G	APTC60DSKM45T1G
600	CoolMOS	70	29	SP1	YES	APTC60DDAM70T1G	APTC60DSKM70T1G
		35	54	SP3F	YES	APTC60DDAM35T3G	APTC60DSKM35T3G
		24	70	SP3F	YES	APTC60DDAM24T3G	APTC60DSKM24T3G
		150	21	SP3F	YES	APTC80DDA15T3G	APTC80DSK15T3G
1000	MOS 7	350	17	SP3F	YES	APT100DDA35T3G	APT100DSK35T3G

MOSFET Power Modules

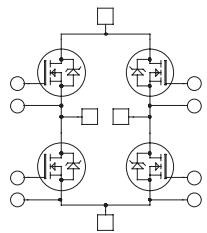

FULL BRIDGE

V_{DSS} (V)	MOSFET Type	$R_{DS(ON)}$ (m Ω)	I_D (A) $T_c=80^\circ\text{C}$	Package	NTC	Part Number
100	FREDFET 5	4.5	207	SP6	-	APTM10HM05FG
		19	50	SP3F	YES	APTM10HM19FT3G
		9	100	SP3F	YES	APTM10HM09FT3G
200	FREDFET 7	20	62	SP4	YES	APTM20HM20FTG
		16	74	SP4	YES	APTM20HM16FTG
		10	125	SP6	-	APTM20HM10FG
		8	147	SP6	-	APTM20HM08FG
		140	18	SP3F	YES	APTM50H14FT3G
500	FREDFET 7	100	24	SP3F	YES	APTM50H10FT3G
		75	32	SP4	YES	APTM50HM75FTG
		75	32	SP3F	YES	APTM50HM75FT3G
		65	37	SP4	YES	APTM50HM65FTG
		65	37	SP3F	YES	APTM50HM65FT3G
		38	64	SP6	-	APTM50HM38FG
		35	70	SP6	-	APTM50HM35FG
	FREDFET 8	150	19	SP1	YES	APTM50H15FT1G
600	CoolMOS	70	29	SP1	YES	APTC60HM70T1G
		45	38	SP1	YES	APTC60HM45T1G
		83	21	SP2	YES	APTC60HM83FT2G
		70	29	SP3F	YES	APTC60HM70T3G
		35	54	SP3F	YES	APTC60HM35T3G
	24	70	SP3F	YES	APTC60HM24T3G	
FREDFET 8	230	15	SP1	YES	APTM60H23FT1G	
800	CoolMOS	150	21	SP1	YES	APTC80H15T1G
		290	11	SP3F	YES	APTC80H29T3G
		150	21	SP3F	YES	APTC80H15T3G
900	CoolMOS	120	23	SP1	YES	APTC90H12T1G
		60	44	SP3F	YES	APTC90HM60T3G
1000	FREDFET 7	450	14	SP3F	YES	APTM100H45FT3G
		350	17	SP4	YES	APTM100H35FTG
		350	17	SP3F	YES	APTM100H35FT3G
	FREDFET 8	180	33	SP6	-	APTM100H18FG
1200	FREDFET 7	460	14	SP3F	YES	APTM100H46FT3G
	FREDFET 7	290	25	SP6	-	APTM120H29FG
	FREDFET 8	1400	6	SP1	YES	APTM120H140FT1G

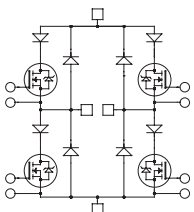
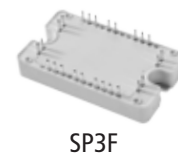
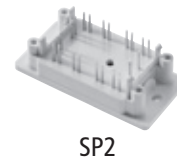

FULL BRIDGE + SERIES AND PARALLEL DIODES

V_{DSS} (V)	MOSFET Type	$R_{DS(ON)}$ (m Ω)	I_D (A) $T_c=80^\circ\text{C}$	Package	NTC	Part Number
200	MOS 7	20	62	SP4	YES	APTM20HM20STG
500	MOS 7	75	32	SP4	YES	APTM50HM75STG
1000	MOS 7	450	13	SP4	YES	APTM100H45STG

ASYMMETRICAL BRIDGE

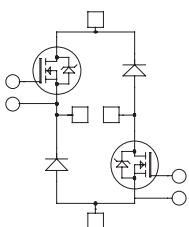

V_{DSS} (V)	MOSFET Type	$R_{DS(ON)}$ (m Ω)	I_D (A) $T_c=80^\circ\text{C}$	Package	NTC	Part Number
100	MOSS	4.5	207	SP6	-	APTM10DHM05G
200	MOS 7	16	77	SP3F	YES	APTM20DHM16T3G
		8	147	SP6	-	APTM20DHM08G
500	MOS 7	38	64	SP6	-	APTM50DHM38G
	MOS 8	65	32	SP3F	YES	APTM50DHM65T3G
600	CoolMOS	24	70	SP3F	YES	APTC60DHM24T3G

MOSFET Power Modules

PHASE LEG

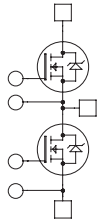

V_{DSS} (V)	MOSFET Type	$R_{DS(ON)}$ (m Ω)	I_D (A) $T_c=80^\circ\text{C}$	Package	NTC	Part Number
100	FREDFET 5	4.5	207	SP4	YES	APTM10AM05FTG
		2.25	370	SP6	option	APTM10AM02FG
200	FREDFET 7	10	125	SP4	YES	APTM20AM10FTG
		8	147	SP4	YES	APTM20AM08FTG
		5	250	SP6	option	APTM20AM05FG
		4	300	SP6	option	APTM20AM04FG
500	FREDFET 7	38	64	SP4	YES	APTM50AM38FTG
		35	70	SP4	YES	APTM50AM35FTG
		19	125	SP6	option	APTM50AM19FG
		17	140	SP6	option	APTM50AM17FG
600	CoolMOS	45	38	SP1	YES	APTC60AM45T1G
		42	40	SP2	-	APTC60AM42F2G
		35	54	SP1	YES	APTC60AM35T1G
		24	70	SP1	YES	APTC60AM24T1G
	24	70	SP2	-	APTC60AM242G	
900	CoolMOS	110	30	SP1	YES	APTM60A11FT1G
		60	44	SP1	YES	APTC90AM60T1G
1000	FREDFET 7	180	33	SP4	YES	APTM100A18FTG
		90	59	SP6	option	APTM100AM90FG
1200	FREDFET 7	400	16	SP1	YES	APTM100A40FT1G
		290	25	SP4	YES	APTM120A29FTG
1200	FREDFET 8	150	45	SP6	option	APTM120A15FG
		650	12	SP1	YES	APTM120A65FT1G



SP1



SP2

PHASE LEG + SERIES AND PARALLEL DIODES

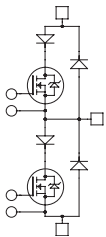

V_{DSS} (V)	MOSFET Type	$R_{DS(ON)}$ (m Ω)	I_D (A) $T_c=80^\circ\text{C}$	Package	NTC	Part Number
200	MOS 7	10	125	SP4	YES	APTM20AM10STG
		6	225	SP6	-	APTM20AM06SG
500	MOS 7	38	64	SP4	YES	APTM50AM38STG
		24	110	SP6	-	APTM50AM24SG
1000	MOS 7	230	26	SP4	YES	APTM100A23STG
		130	49	SP6	-	APTM100A13SG
1200	MOS 7	200	37	SP6	-	APTM120A20SG

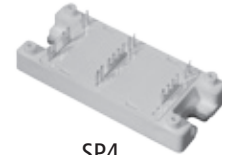

SP4

PHASE LEG + SERIES DIODES

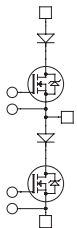

V_{DSS} (V)	MOSFET Type	$R_{DS(ON)}$ (m Ω)	I_D (A) $T_c=80^\circ\text{C}$	Package	NTC	Part Number
1000	MOS 7	130	49	SP6	-	APTM100A13DG
1200	MOS 7	200	37	SP6	-	APTM120A20DG



SP6

TRIPLE PHASE LEG

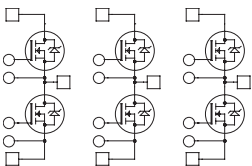

V_{DSS} (V)	MOSFET Type	$R_{DS(ON)}$ (m Ω)	I_D (A) $T_c=80^\circ\text{C}$	Package	NTC	Part Number
75	MOSFET	4.2	90	SP6-P	option	APTM08TAM04PG
100	FREDFET 5	19	50	SP6-P	option	APTM10TAM19FPG
		9	100	SP6-P	option	APTM10TAM09FPG
200	FREDFET 7	16	74	SP6-P	option	APTM20TAM16FPG
500	FREDFET 7	65	37	SP6-P	option	APTM50TAM65FPG
		35	54	SP6-P	option	APTC60TAM35PG
600	CoolMOS	24	70	SP6-P	YES	APTC60TAM24TPG
		150	21	SP6-P	option	APTC80TA15PG
900	CoolMOS	60	44	SP6-P	YES	APTC90TAM60TPG
1000	FREDFET 7	350	17	SP6-P	option	APTM100TA35FPG



SP6-P

MOSFET Power Modules

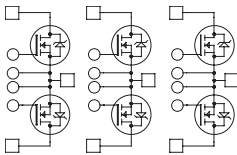

TRIPLE DUAL COMMON SOURCE

V_{DSS} (V)	MOSFET Type	$R_{DS(ON)}$ (m Ω)	I_D (A) $T_c=80^\circ\text{C}$	Package	NTC	Part Number
100	MOS 5	9	100	SP6-P	option	APTM10TDUM09PG
600	CoolMOS	35	54	SP6-P	option	APTC60TDUM35PG
800	CoolMOS	150	21	SP6-P	option	APTC80TDU15PG
1200	MOS 7	570	13	SP6-P	option	APTM120TDU57PG



SP1

DUAL COMMON SOURCE

V_{DSS} (V)	MOSFET Type	$R_{DS(ON)}$ (m Ω)	I_D (A) $T_c=80^\circ\text{C}$	Package	NTC	Part Number
100	MOS 5	2.25	370	SP6	-	APTM10DUM02G
200	MOS 7	8	147	SP4	YES	APTM20DUM08TG
		5	250	SP6	-	APTM20DUM05G
		4	300	SP6	-	APTM20DUM04G
500	MOS 7	35	70	SP4	YES	APTM50DUM35TG
		17	140	SP6	-	APTM50DUM17G
1000	MOS 7	90	59	SP6	-	APTM100DUM90G
1200	MOS 7	150	45	SP6	-	APTM120DU15G

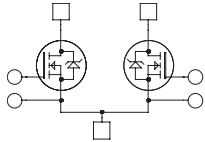

SP3F

SINGLE SWITCH

V_{DSS} (V)	MOSFET Type	$R_{DS(ON)}$ (m Ω)	I_D (A) $T_c=80^\circ\text{C}$	Package	NTC	Part Number
100	FREDFET 5	2.25	430	SP6	option	APTM10UM02FAG
		1.5	640	SP6	option	APTM10UM01FAG
200	FREDFET 7	3	434	SP6	option	APTM20UM03FAG
500	FREDFET 7	9	371	SP6	option	APTM50UM09FAG
1000	FREDFET 7	60	97	SP6	option	APTM100UM60FAG
		45	160	SP6	option	APTM100UM45FAG
1200	FREDFET 7	70	126	SP6	option	APTM120UM70FAG

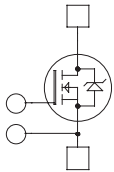

SP4

SINGLE SWITCH + SERIES DIODE

V_{DSS} (V)	MOSFET Type	$R_{DS(ON)}$ (m Ω)	I_D (A) $T_c=80^\circ\text{C}$	Package	NTC	Part Number
1000	MOS 7	65	110	SP6	-	APTM100UM65DAG
		45	160	SP6	-	APTM100UM45DAG
1200	MOS 7	70	126	SP6	-	APTM120UM70DAG

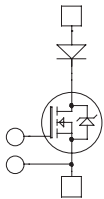

SP6

SINGLE SWITCH + SERIES AND PARALLEL DIODES

V_{DSS} (V)	MOSFET Type	$R_{DS(ON)}$ (m Ω)	I_D (A) $T_c=80^\circ\text{C}$	Package	NTC	Part Number
200	MOS 7	4	310	SP6	option	APTM20UM04SAG
500	MOS 7	13	250	SP6	option	APTM50UM13SAG
1000	MOS 7	65	110	SP6	option	APTM100UM65SAG
1200	MOS 7	100	86	SP6	option	APTM120U10SAG

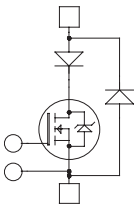

SP6-P

INTERLEAVED PFC

V_{DSS} (V)	MOSFET Type	$R_{DS(ON)}$ (m Ω)	I_D (A) $T_c=80^\circ\text{C}$	Package	NTC	Part Number
600	CoolMOS	45	38	SP1	YES	APTC60VDAM45T1G
		24	70	SP3F	YES	APTC60VDAM24T3G

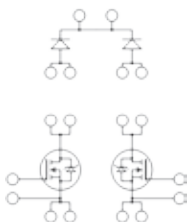

MOSFET Power Modules

SINGLE AND DUAL LINEAR MOSFET

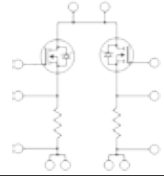
V_{DSS} (V)	MOSFET Type	$R_{DS(ON)}$ (m Ω)	Shunt Resistor (mR)	Package	NTC		
100	MOS 5	9	4.4	SP1 or SP3F	YES	APTML10UM09R004T1AG	APTML102UM09R004T3AG
200		18	10		YES	APTML20UM18R010T1AG	APTML202UM18R010T3AG
500	MOSFET Linear	90	20		YES	APTML50UM90R020T1AG	APTML502UM90R020T3AG
600		125	20		YES	APTML60U12R020T1AG	APTML602U12R020T3AG
1000	MOS 4 Linear	600	20		YES	APTML100U60R020T1AG	APTML1002U60R020T3AG



SP1



SP3F

Renewable Energy Power Modules

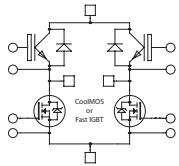

FULL BRIDGE

V_{CES} (V)	Technology	I_c (A) $T_c=80^\circ\text{C}$	$V_{CE(on)}$ (V) at rated I_c	Package	NTC	Part Number
600	Mix Trench IGBT & CoolMOS	50	83mR/1.5	SP1	YES	APTCV40H60CT1G
		50	45mR/1.5	SP3F	YES	APTCV50H60T3G



SP1



SP3F

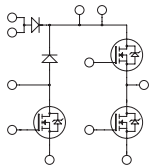

PFC + BYPASS DIODE + PHASE LEG

V_{CES} (V)	Technology	I_c (A) $T_c=80^\circ\text{C}$	$V_{CE(on)}$ (V) at rated I_c	Package	NTC	Special	Part Number
600	CoolMOS	38	45mR	SP1	N/A	10A PFC SiC diode	APTC60AM45BC1G
		38	45mR	SP1	N/A	-	APTC60AM45B1G
		27	83mR	SP1	N/A	10A PFC SiC diode	APTC60AM83BC1G
		27	83mR	SP1	N/A	-	APTC60AM83B1G

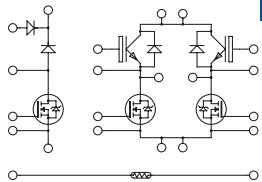

PFC + BYPASS DIODE + FULL BRIDGE

V_{CES} (V)	Technology	I_c (A) $T_c=80^\circ\text{C}$	$V_{CE(on)}$ (V) at rated I_c	Package	NTC	Special	Part Number
600	Mix Trench IGBT & CoolMOS	38	1.5/45mR	SP3F	YES	20A PFC SiC diode	APTCV60HM45BC20T3G
		38	1.5/45mR	SP3F	YES	-	APTCV60HM45BT3G
		29	1.5/70mR	SP3F	YES	-	APTCV60HM70BT3G
	CoolMOS	29	70mR	SP3F	YES	-	APTC60HM70BT3G

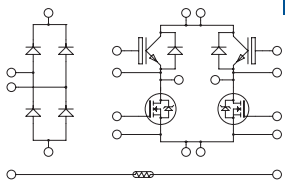

SECONDARY FAST RECTIFIER + FULL BRIDGE

V_{CES} (V)	Technology	I_c (A) $T_c=80^\circ\text{C}$	$V_{CE(on)}$ (V) at rated I_c	Package	NTC	Special	Part Number
600	Mix Trench IGBT & CoolMOS	38	1.5/45mR	SP3F	YES	20A SiC antiparallel diode	APTCV60HM45RCT3G
		38	1.5/45mR	SP3F	YES	-	APTCV60HM45RT3G
		29	1.5/70mR	SP3F	YES	-	APTCV60HM70RT3G
	CoolMOS	29	70mR	SP3F	YES	-	APTC60HM70RT3G
	TRENCH 3	50	1.5	SP3F	YES	-	APTGT50H60RT3G

Renewable Energy Power Modules

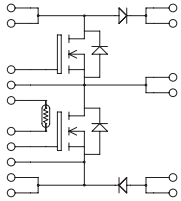

BOOST BUCK

V_{CES} (V)	Technology	I_C (A) $T_C=80^\circ\text{C}$	$V_{CE(on)}$ (V) at rated I_C	Package	NTC	Part Number
600	CoolMOS	70	24mR	SP3F	YES	APTCC60BBM24T3G
600	TRENCH 3	100	1.5	SP3F	YES	APTGT100BB60T3G



SP1

3-LEVEL NPC INVERTER

V_{CES} (V)	Technology	I_C (A) $T_C=80^\circ\text{C}$	$V_{CE(on)}$ (V) at rated I_C	Package	NTC	Part Number
600	TRENCH 3	20	1.5	SP1	-	APTGT20TL601G
		30	1.5	SP3F	YES	APTGT30TL60T3G
		30	1.5	SP1	-	APTGT30TL601G
		50	1.5	SP3F	YES	APTGT50TL60T3G
		50	1.5	SP1	-	APTGT50TL601G
		75	1.5	SP3F	YES	APTGT75TL60T3G
		100	1.5	SP3F	YES	APTGT100TL60T3G
		150	1.5	SP6	-	APTGT150TL60G
		200	1.5	SP6	-	APTGT200TL60G
		300	1.5	SP6	-	APTGT300TL60G
650	Trench 3	300	1.5	SP6	-	APTGT300TL65G
		400	1.5	SP6	-	APTGT400TL65G
1200	TRENCH 4	60	1.85	SP3F	YES	APTGL60TL120T3G
		240	1.8	SP6	-	APTGL240TL120G
1700	TRENCH 3	100	2.0	SP6	-	APTGT100TL170G

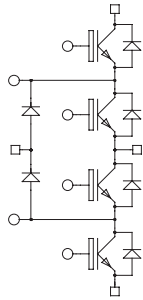

SP3F



SP6 3-Level

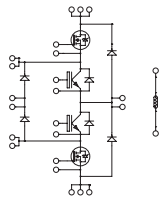

V_{CES} (V)	Technology	$R_{DS(on)}$ CoolMOS (m Ω)	$V_{CE(on)}$ IGBT (V) / I_C (A)	Package	NTC	Part Number
600	Mix Trench IGBT & CoolMOS	24	1.5/75	SP3F	YES	APTCV60TLM24T3G
		45	1.5/75	SP3F	YES	APTCV60TLM45T3G
		70	1.5/50	SP3F	YES	APTCV60TLM70T3G
		99	1.5/30	SP3F	YES	APTCV60TLM99T3G
900	Mix Trench IGBT & CoolMOS	120	1.85/50	SP3F	YES	APTCV90TL12T3G

T-TYPE 3-LEVEL INVERTER

V_{CES} (V)	Technology	I_C (A) $T_C=80^\circ\text{C}$	$V_{CE(on)}$ (V) at rated I_C	Package	NTC	Special	Part Number
600/1200	TRENCH 4 FAST	40	2.05	SP3F	YES	10A/600V SiC	APTGLQ40HR120CT3G
		80	2.05	SP3F	YES	30A/600V SiC	APTGLQ80HR120CT3G
		200	2.05	SP6	NO	-	APTGLQ200HR120G

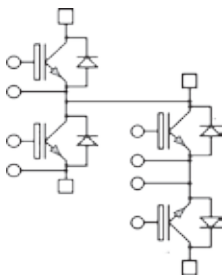

Power Modules with SiC Schottky Diodes

Silicon Carbide (SiC) Schottky Diodes offer superior dynamic and thermal performance over conventional Silicon power diodes. The main advantages of the SiC Schottky Diodes are:

- Essentially zero forward and reverse recovery = reduced switch and diode switching losses
- Temperature independent switching behavior = stable high temperature performance
- Positive temperature coefficient of VF = ease of parallel operation
- Usable 175°C Junction Temperature = safely operate at higher temperatures

Extremely fast switching of SiC Schottky diode enables designs with:

- Improved System Efficiency
- Higher Reliability
- Lower System Switching Losses
- Lower System Cost
 - Smaller EMI Filter
 - Smaller Magnetic Components
 - Smaller Heat-Sink
 - Smaller Switches, Eliminate Snubbers
- Reduced System Size
 - Fewer / Smaller Components

Applications:

- PFC
- Output Rectification
- Solar Inverter
- Motor Control
- Snubber Diode

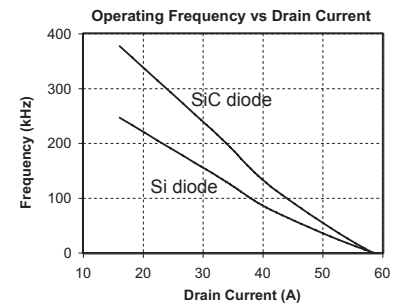

Diode Power Modules with SiC Diodes

DUAL DIODE

V_{RRM} (V)	DIODE Type	IF (A) $T_c=100^\circ\text{C}$	VF (V) $T_j=25^\circ\text{C}$	Package	Anti-Parallel	Parallel
600	SiC	20	1.6	SOT-227	APT2X20DC60J	APT2X21DC60J
		30	1.6	SOT-227	APT2X30DC60J	APT2X31DC60J
		40	1.6	SOT-227	APT2X40DC60J	APT2X41DC60J
		50	1.6	SOT-227	APT2X50DC60J	APT2X51DC60J
		60	1.6	SOT-227	APT2X60DC60J	APT2X61DC60J
1200	SiC	20	1.6	SOT-227	APT2X20DC120J	APT2X21DC120J
		40	1.6	SOT-227	APT2X40DC120J	APT2X41DC120J
		50	1.6	SOT-227	APT2X50DC120J	APT2X51DC120J
		60	1.6	SOT-227	APT2X60DC120J	APT2X61DC120J



SOT-227



SP1



SP3F

FULL BRIDGE

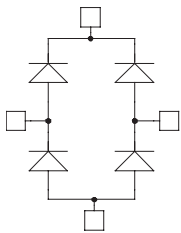

V_{RRM} (V)	DIODE Type	IF (A) $T_c=100^\circ\text{C}$	VF (V) $T_j=25^\circ\text{C}$	Package	Part Number
600	SiC	20	1.6	SP1	APTDC20H601G
		40	1.6	SP1	APTDC40H601G
		40	1.6	SOT-227	APT40DC60HJ
1200	SiC	10	1.6	SOT-227	APT10DC120HJ
		20	1.6	SP1	APTDC20H1201G
		20	1.6	SOT-227	APT20DC120HJ
		40	1.6	SP1	APTDC40H1201G
		40	1.6	SOT-227	APT40DC120HJ

IGBT Power Modules with SiC Diodes

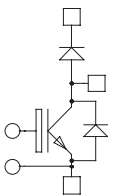

BOOST CHOPPER

V_{RRM} (V)	IGBT Type	IC (A) $T_c=80^\circ\text{C}$	$V_{CE(on)}$ (V) at rated Ic	Package	NTC	Part Number
1200	TRENCH 4 FAST	25	2.05	SOT-227	-	APT25GLQ120JCU2
		40	2.05	SOT-227	-	APT40GLQ120JCU2

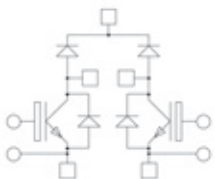

DUAL CHOPPER

V_{RRM} (V)	IGBT Type	IC (A) $T_c=80^\circ\text{C}$	$V_{CE(on)}$ (V) at rated Ic	Package	NTC	Part Number
1200	TRENCH 4 FAST	40	2.05	SP3F	YES	APTGLQ40DDA120CT3G

Power Modules with SiC Schottky Diodes

MOSFETs & CoolMOS™ Power Modules with SiC Diodes

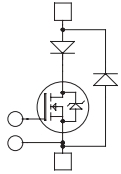

SINGLE SWITCH + SERIES FRED AND SIC PARALLEL DIODES

V _{DSS} (V)	MOSFET Type	R _{DS(ON)} (mΩ)	I _D (A) T _C =80° C	Package	NTC	Part Number
1000	MOS7	65	110	SP6	option	APTM100UM65SCAVG
1200	MOS7	100	86	SP6	option	APTM120U10SCAVG



SOT-227

CHOPPER

V _{DSS} (V)	MOSFET Type	R _{DS(ON)} (mΩ)	I _D (A) T _C =80° C	Package	NTC	...DA... or U2	...SK... or U3
500	MOS8	65	43	SOT-227	-	APT58M50JCU2	N/A
600	CoolMOS	45	38	SOT-227	-	APT50N60JCCU2	N/A
		24	70	SP1	YES	N/A	APTC60SKM24CT1G
900	CoolMOS	18	107	SP4	YES	APTC60DAM18CTG	N/A
		120	25	SOT-227	-	APT33N90JCCU2	N/A
1000	MOS 8	60	44	SP1	YES	APTC90DAM60CT1G	APTC90SKM60CT1G
		330	20	SOT-227	-	APT26M100JCU2	APT26M100JCU3
1200	MOS 8	560	15	SOT-227	-	APT20M120JCU2	APT20M120JCU3
		300	23	SP1	YES	APTM120DA30CT1G	N/A



SP1



SP3F

PHASE LEG + SERIES FRED AND SIC PARALLEL DIODES

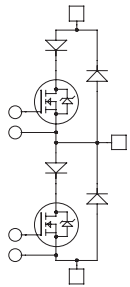

V _{DSS} (V)	MOSFET Type	R _{DS(ON)} (mΩ)	I _D (A) T _C =80° C	Package	NTC	Part Number
500	MOS 7	38	67	SP4	YES	APTM50AM38SCTG
		24	110	SP6	-	APTM50AM24SCG
600	CoolMOS	35	54	SP4	YES	APTC60AM35SCTG
		24	70	SP4	YES	APTC60AM24SCTG
		18	107	SP6	-	APTC60AM18SCG
900	CoolMOS	60	44	SP4	YES	APTC90AM60SCTG
800	CoolMOS	150	21	SP4	YES	APTC80A15SCTG
		100	32	SP4	YES	APTC80A10SCTG
		75	43	SP6	-	APTC80AM75SCG
1000	MOS 7	130	49	SP6	-	APTM100A13SCG



SP4



SP6

FULL BRIDGE + SERIES FRED AND SIC PARALLEL DIODES

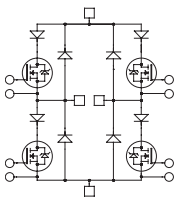

V _{DSS} (V)	MOSFET Type	R _{DS(ON)} (mΩ)	I _D (A) T _C =80° C	Package	NTC	Part Number
500	MOS 7	75	34	SP4	YES	APTM50HM75SCTG
600	CoolMOS	70	29	SP4	YES	APTC60HM70SCTG
		45	38	SP4	YES	APTC60HM45SCTG
800	CoolMOS	290	11	SP4	YES	APTC80H29SCTG
900	CoolMOS	120	23	SP4	YES	APTC90H12SCTG
1000	MOS 7	450	14	SP4	YES	APTM100H45SCTG



SP6-P

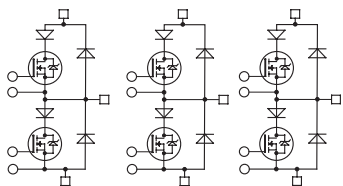

TRIPLE PHASE LEG

V _{DSS} (V)	MOSFET Type	R _{DS(ON)} (mΩ)	I _D (A) T _C =80° C	Package	NTC	Part Number
600	CoolMOS	24	87	SP6-P	YES	APTC60TAM21SCTPAG
1000	MOS 7	350	50	SP6-P	YES	APTM100TA35SCTPG

SiC MOSFET Power Modules

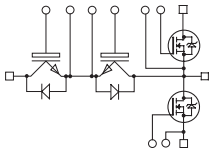

T-TYPE 3-LEVEL INVERTER						
V_{CES} (V)	Technology	$R_{DS(ON)}$ (m Ω)	I_D (A) $T_C=80^\circ\text{C}$	Package	NTC	Part Number
600/1200	IGBT & SiC MOSFET	110	20	SP3F	YES	APTMC120HR11CT3AG
		40	50	SP3F	YES	APTMC120HRM40CT3AG



SOT-227

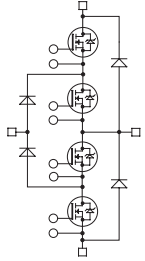

3-LEVEL NPC INVERTER						
V_{CES} (V)	Technology	$R_{DS(ON)}$ (m Ω)	I_D (A) $T_C=80^\circ\text{C}$	Package	NTC	Part Number
600	SiC MOSFET	110	20	SP3F	YES	APTMC60TL11CT3AG
		55	40	SP3F	YES	APTMC60TLM55CT3AG
		14	160	SP6	-	APTMC60TLM14CAG

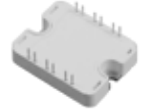

SP1

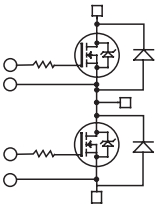

PHASE LEG						
V_{CES} (V)	Technology	$R_{DS(ON)}$ (m Ω)	I_D (A) $T_C=80^\circ\text{C}$	Package	NTC	Part Number
700	SiC MOSFET	30	97A	SP1	YES	APTSM70AM30CT1AG
		15	194A	SP3F	YES	APTSM70AM15CT3AG
		7	440A	D3	-	APTSM70AM06CD3AG
		6	480A	SP6	YES	APTSM70AM05CT6AG
1200	SiC MOSFET	55	40	SP1	YES	APTMC120AM55CT1AG
		25	80	SP3F	YES	APTMC120A25CT3AG
		20	108	SP1	YES	APTMC120AM20CT1AG
		16	102	D3	-	APTMC120AM16CD3AG
		12	150	SP3F	YES	APTMC120AM12CT3AG
		9	200	SP3F	YES	APTMC120AM09CT3AG
		8	200	D3	-	APTMC120AM08CD3AG
1700	SiC MOSFET	60	40	SP1	YES	APTMC170AM60CT1AG
		30	80	SP1	YES	APTMC170AM30CT1AG



SP3F

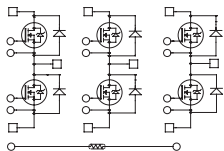

TRIPLE PHASE LEG						
V_{CES} (V)	Technology	$R_{DS(ON)}$ (m Ω)	I_D (A) $T_C=80^\circ\text{C}$	Package	NTC	Part Number
700	SiC MOSFET	20	146	SP6-P	YES	APTSM70TAM20CTPAG
		60	49	SP3F	YES	APTSM70TAM60CT3AG
		100	30	SP3F	YES	APTSM120TA10CT3AG
1200	SiC MOSFET	34	55	SP3F	YES	APTMC120TAM34CT3AG
		33	60	SP6-P	YES	APTMC120TAM33CTPAG
		33	89	SP6-P	YES	APTSM120TAM33CTPAG
		17	100	SP6-P	YES	APTMC120TAM17CTPAG
		12	150	SP6-P	YES	APTMC120TAM12CTPAG
		NEW!	NEW!	NEW!	NEW!	NEW!



SP6



BOOST CHOPPER						
V_{CES} (V)	Technology	$R_{DS(ON)}$ (m Ω)	I_D (A) $T_C=80^\circ\text{C}$	Package	NTC	Part Number
700	SiC MOSFET	60	49	SOT-227	-	APT50SM70JCU2
1200	SiC MOSFET	100	30	SOT-227	-	APT30SM120JCU2
		40	50	SOT-227	-	APT50MC120JCU2



D3

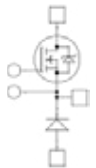

BUCK CHOPPER						
V_{CES} (V)	Technology	$R_{DS(ON)}$ (m Ω)	I_D (A) $T_C=80^\circ\text{C}$	Package	NTC	Part Number
700	SiC MOSFET	60	49	SOT-227	-	APT50SM70JCU3
1200	SiC MOSFET	100	30	SOT-227	-	APT30SM120JCU3



SP6-P

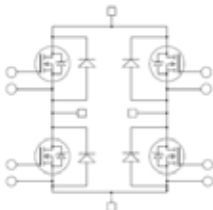

FULL BRIDGE						
V_{CES} (V)	Technology	$R_{DS(ON)}$ (m Ω)	I_D (A) $T_C=80^\circ\text{C}$	Package	NTC	Part Number
700	SiC MOSFET	30	97	SP3F	YES	APTSM70HM30CT3AG
1200	SiC MOSFET	50	59	SP3F	YES	APTSM120HM50CT3AG
		17	110	SP3F	YES	APTMC120HM17CT3AG

NEW!

NEW!

NEW!

DIODE Power Modules

SINGLE DIODE

V_{RRM} (V)	DIODE Type	IF (A) $T_c=80^\circ\text{C}$	VF (V) $T_j=25^\circ\text{C}$	Package	
200	FRED	500	1.1	LP4	
400		500	1.5		
600		450	1.8		
1000		430	2.3		
1200		400	2.5		
					APTDF500U20G APTDF500U40G APTDF450U60G APTDF430U100G APTDF400U120G



3-PHASE BRIDGE

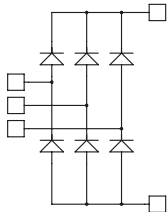

V_{RRM} (V)	DIODE Type	IF (A) $T_c=80^\circ\text{C}$	VF (V) $T_j=25^\circ\text{C}$	Package	Part Number
1600	RECTIFIER	40	1.3	SP1	APTDR40X1601G
		90	1.3	SP1	APTDR90X1601G
800 1200 1600 1800	RECTIFIER	50	1.45	SM2-1	MSDM50-08/12/16/18
		52	1.8	SM2	MSD52-08/12/16/18
		75	1.6	SM2	MSD75-08/12/16/18
		75	1.38	SM2-1	MSDM75-08/12/16/18
		100	1.9	SM3	MSD100-08/12/16/18
		100	1.7	SM2-1	MSDM100-08/12/16/18
		130	1.8	SM3	MSD130-08/12/16/18
		150	1.28	SM3-1	MSDM150-08/12/16/18
		160	1.65	SM3	MSD160-08/12/16/18
		200	1.55	SM3	MSD200-08/12/16/18
200	1.31	SM3-1	MSDM200-08/12/16/18		



FULL BRIDGE

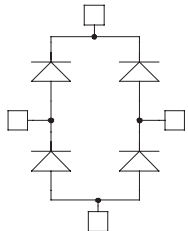

V_{RRM} (V)	DIODE Type	IF (A) $T_c=80^\circ\text{C}$	VF (V) $T_j=25^\circ\text{C}$	Package Style	Part Number
200	FRED	30	1.0	SOT-227	APT30DF20HJ
		60	1.0	SOT-227	APT60DF20HJ
		100	1.0	SP4	APTDF100H20G
600		30	1.8	SP1	APTDF30H601G
		30	1.8	SOT-227	APT30DF60HJ
		60	1.8	SOT-227	APT60DF60HJ
		60	1.8	SP1	APTDF60H601G
		75	1.6	SOT-227	APT75DL60HJ
		100	1.6	SOT-227	APT100DL60HJ
	100	1.6	SP1	APTDF100H601G	
	200	1.6	SP6	APTDF200H60G	
	1000	30	2.1	SOT-227	APT30DF100HJ
		100	2.1	SP4	APTDF100H100G
200		2.1	SP6	APTDF200H100G	
1200	30	2.6	SP1	APTDF30H1201G	
	60	2.6	SP1	APTDF60H1201G	
1700	200	2.4	SP6	APTDF200H120G	
	50	1.8	SOT-227	APT50DF170HJ	
	75	1.8	SOT-227	APT75DF170HJ	
	100	2.2	SP4	APTDF100H170G	
	200	2.2	SP6	APTDF200H170G	



COMMON CATHODE - COMMON ANODE - DOUBLER

V_{RRM} (V)	DIODE Type	IF (A) per Diode	VF (V) $T_j=25^\circ\text{C}$	Package			
200	FRED	400	1.0	SP6	Common Cathode	Common Anode	Doubler
600			1.6		APTDF400KK20G	APTDF400AA20G	APTDF400AK20G
1000			2.1		APTDF400KK60G	APTDF400AA60G	APTDF400AK60G
1200			2.4		APTDF400KK100G	APTDF400AA100G	APTDF400AK100G
1700			2.2		APTDF400KK120G	APTDF400AA120G	APTDF400AK120G
			2.2		APTDF400KK170G	APTDF400AA170G	APTDF400AK170G



Package Outlines

D³ Pak or TO-268

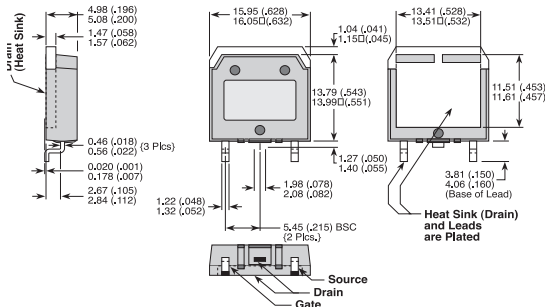

TO-220 [KF]

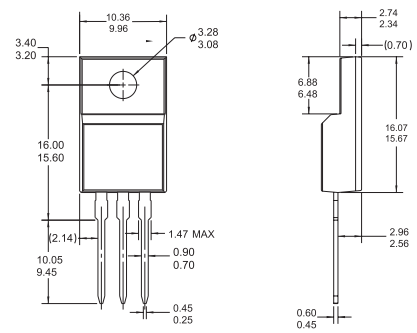

TO-220 2-Lead

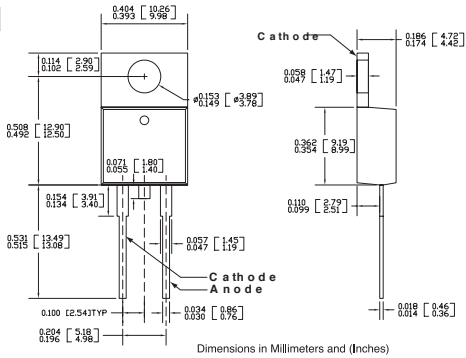

TO-220 3-Lead

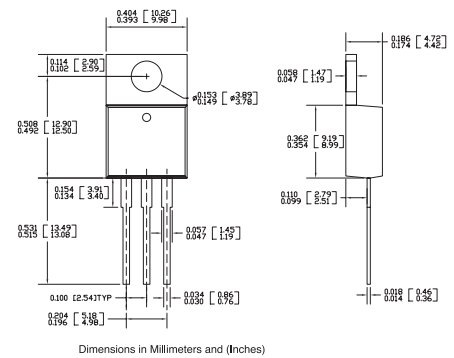

TO-247 3-Lead

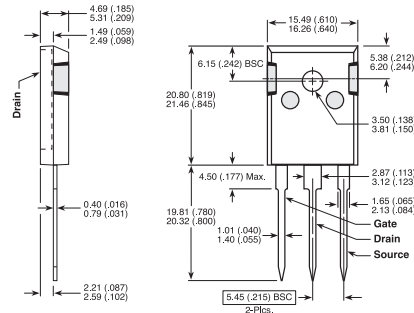

TO-247 2-Lead

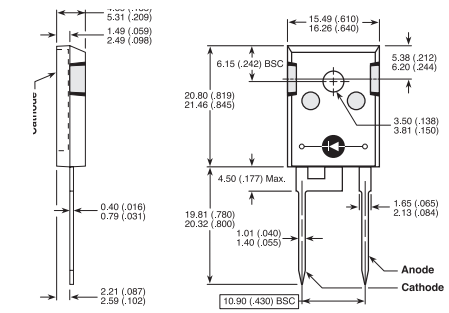

T-MAX[®]

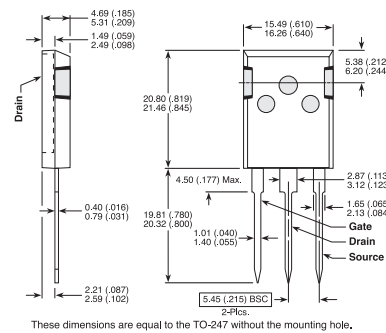

These dimensions are equal to the TO-247 without the mounting hole.

TO-264

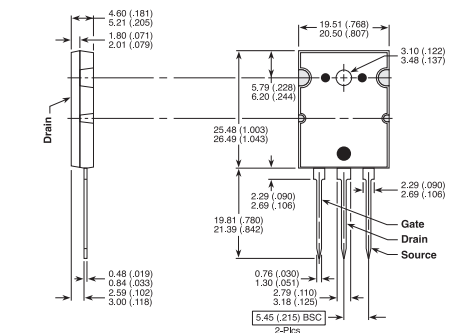

264 MAX[™]

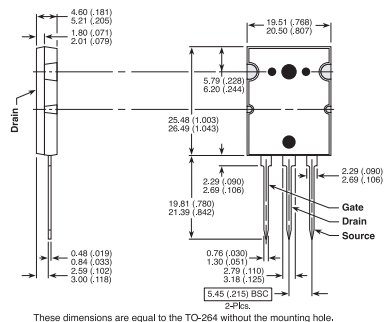

These dimensions are equal to the TO-264 without the mounting hole.

ISOTOP[®] or SOT-227

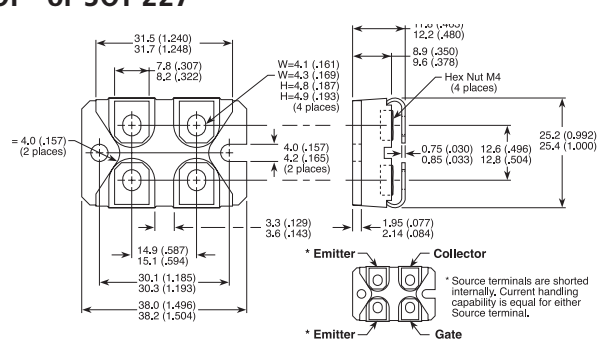

Power Module Outlines

D3

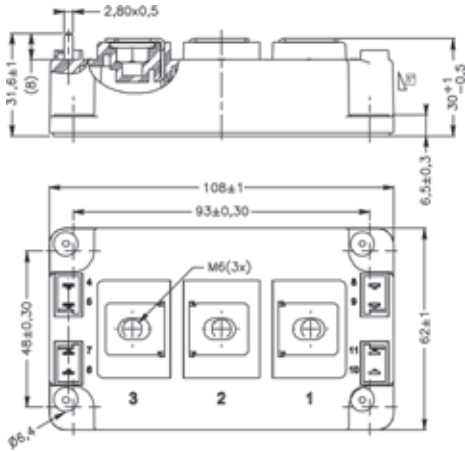

D4

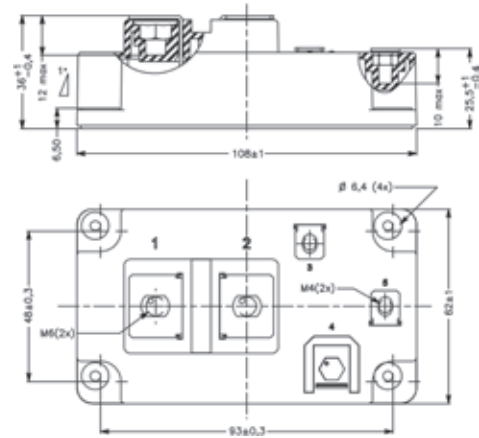

LP4

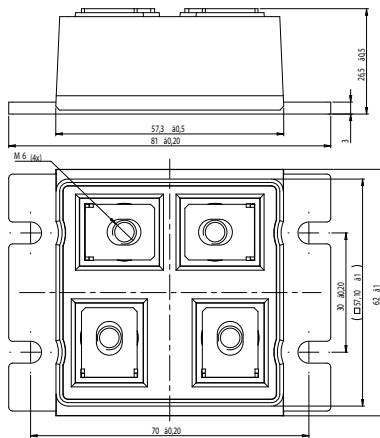

LP8

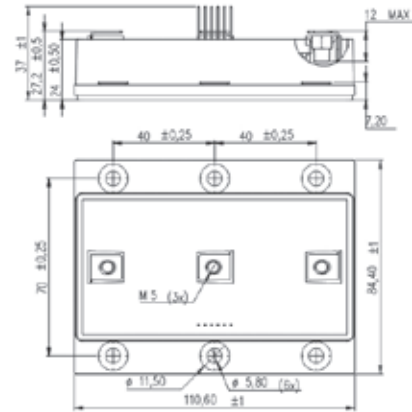

SP1

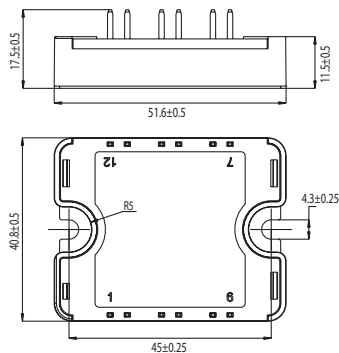

SP2

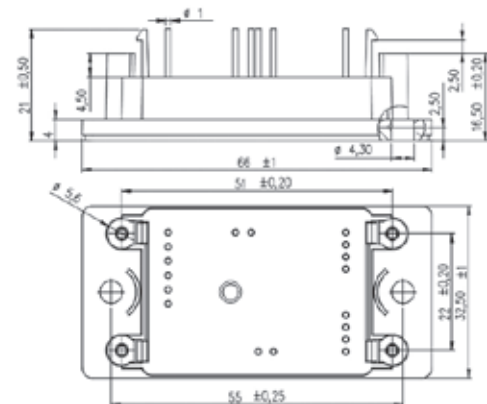

Power Module Outlines

Pin out location depends on the module configuration. Please refer to the product datasheet for pins assignment. All dimensions in millimeters.

SM2

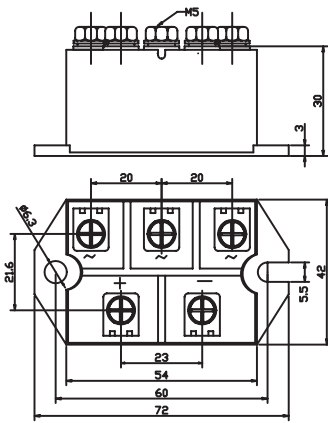

SM2-1

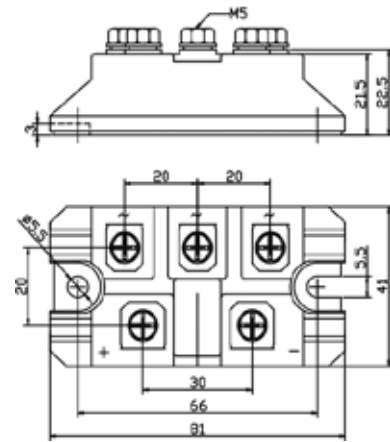

SM3

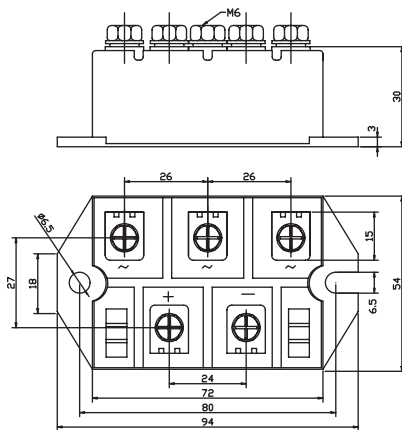

SM3-1

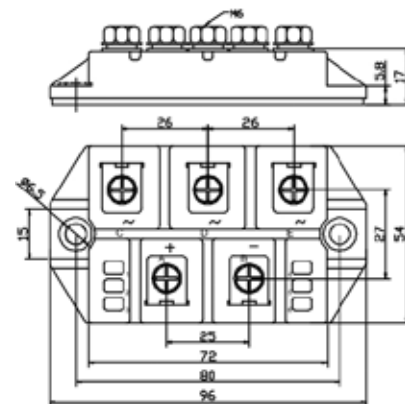

Microsemi Power Portfolio 2016

Microsemi Power Semiconductor Products

405 SW Columbia Street
Bend, Oregon 97702
Tel: 541-382-8028
Toll Free USA: 800-522-0809
Fax: (541) 388-0364
Email: sales.support@microsemi.com

Microsemi Power Modules

26 rue de Campilleau
33520 Bruges - France
Tel: +33-557 921515
Fax: +33-556 479761
Email: sales.support@microsemi.com

Microsemi Corporate Headquarters

One Enterprise, Aliso Viejo, CA 92656 USA
Within the USA: +1 (800) 713-4113
Outside the USA: +1 (949) 380-6100
Sales: +1 (949) 380-6136
Fax: +1 (949) 215-4996
email: sales.support@microsemi.com
www.microsemi.com



Microsemi Corporate Headquarters

One Enterprise, Aliso Viejo, CA 92656 USA
Within the USA: +1 (800) 713-4113
Outside the USA: +1 (949) 380-6100
Sales: +1 (949) 380-6136
Fax: +1 (949) 215-4996
email: sales.support@microsemi.com
www.microsemi.com

©2016 Microsemi Corporation. All rights reserved. Microsemi and the Microsemi logo are registered trademarks of Microsemi Corporation. All other trademarks and service marks are the property of their respective owners.

Microsemi Corporation (Nasdaq: MSCC) offers a comprehensive portfolio of semiconductor and system solutions for communications, defense and security, aerospace, and industrial markets. Products include high-performance and radiation-hardened analog mixed-signal integrated circuits, FPGAs, SoCs, and ASICs; power management products; timing and synchronization devices and precise time solutions; voice processing devices; RF solutions; discrete components; enterprise storage and communications solutions, security technologies, and scalable anti-tamper products; Ethernet solutions; Power-over-Ethernet ICs and midspans; custom design capabilities and services. Microsemi is headquartered in Aliso Viejo, California, and has approximately 4,800 employees worldwide. Learn more at www.microsemi.com.

Microsemi makes no warranty, representation, or guarantee regarding the information contained herein or the suitability of its products and services for any particular purpose, nor does Microsemi assume any liability whatsoever arising out of the application or use of any product or circuit. The products sold hereunder and any other products sold by Microsemi have been subject to limited testing and should not be used in conjunction with mission-critical equipment or applications. Any performance specifications are believed to be reliable but are not verified, and Buyer must conduct and complete all performance and other testing of the products, alone and together with, or installed in, any end-products. Buyer shall not rely on any data and performance specifications or parameters provided by Microsemi. It is the Buyer's responsibility to independently determine suitability of any products and to test and verify the same. The information provided by Microsemi hereunder is provided "as is, where is" and with all faults, and the entire risk associated with such information is entirely with the Buyer. Microsemi does not grant, explicitly or implicitly, to any party any patent rights, licenses, or any other IP rights, whether with regard to such information itself or anything described by such information. Information provided in this document is proprietary to Microsemi, and Microsemi reserves the right to make any changes to the information in this document or to any products and services at any time without notice.