

Optical Node RF Amplifier 50 - 1200 MHz

Rev. V5

Features

- -8 dBm to +2 dBm Optical Input Range
- Low Equivalent Input Noise (EIN): 3.2 pA/rtHz
- Single +5 V Bias
- 29 dB Gain at 55 MHz; 34 dB Gain at 1000 MHz
- 27 dB Gain Control Range
- +24 dBmV/ch Output at 550 MHz
- Lead-Free 4 mm PQFN-24LD Plastic Package
- Halogen-Free “Green” Mold Compound
- RoHS* Compliant

Description

The MAAM-010333 provides high gain, low noise and low distortion amplification for optical node applications.

The MAAM-010333 is fabricated using MACOMs’ low noise GaAs pHEMT technology in a lead-free 4 mm 24-lead package. The amplifier requires a minimal number of off-chip components resulting in a highly integrated low cost solution.

Ordering Information^{1,2}

Part Number	Description
MAAM-010333-TR1000	1000 Piece Reel
MAAM-010333-TR3000	3000 Piece Reel
MAAM-010333-001SMB	Sample Test Board
MAMU-011089-SMBPPR	Reference design PCB including 2 nd stage MAAM-007807 amplifier

1. Reference Application Note M513 for reel size information.
2. All sample boards include 5 loose parts.

* Restrictions on Hazardous Substances, European Union Directive 2011/65/EU.

Functional Schematic

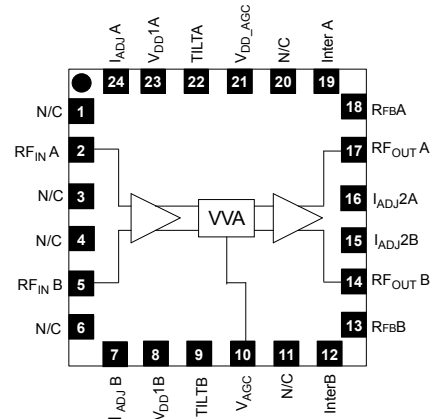

Pin Configuration³

Pin No.	Pin Name	Description
1	N/C	No Connection
2	RF _{IN} A	RF Input A
3	N/C	No Connection
4	N/C	No Connection
5	RF _{IN} B	RF Input B
6	N/C	No Connection
7	I _{ADJ} B	Current Adjust
8	V _{DD} 1B	+ 5V Bias Voltage
9	TiltB	Tilt Connection
10	V _{AGC}	AGC Control Voltage: 0V to 3V
11	N/C	No Connection
12	InterB	Interstage Pin
13	R _{FB} B	Feedback Resistor
14	RF _{OUT} B	RF Output B
15	I _{ADJ} 2B	Current Adjust
16	I _{ADJ} 2A	Current Adjust
17	RF _{OUT} A	RF Output A
18	R _{FB} A	Feedback Resistor
19	InterA	Interstage Pin
20	N/C	No Connection
21	V _{DD} _AGC	+ 5V AGC Bias Voltage
22	TiltA	Tilt Connection
23	V _{DD} 1A	+ 5V Bias Voltage
24	I _{ADJ} A	Current Adjust
25	Paddle	RF & DC Ground

3. The exposed pad centered on the package bottom must be connected to RF and DC ground.

Optical Node RF Amplifier 50 - 1200 MHz

Rev. V5

Electrical Specifications⁴: $V_{DD} = +5\text{ V}$ Regulated Supply⁵, $T_A = 25^\circ\text{C}$, $Z_0 = 75\ \Omega$

Parameter	Test Conditions	Units	Min.	Typ.	Max.
Trans-Impedance Gain ^{6,7}	50 MHz	dB	26.5	29.0	30.5
	870 MHz		31.0	33.0	35.0
	1 GHz		31.5	34.0	35.5
Gain Tilt ⁸	$V_{AGC} = +3\text{ V}$ $V_{AGC} = 0\text{ V}$	dB	-	5 7	-
Gain Flatness ⁹	V_{AGC} : 0 to 3 V	dB		0.7	
Gain Control Range	50 MHz	dB	25.5	29.0	32.0
	870 MHz		23.0	26.0	29.0
	1 GHz		24.0	27.0	30.0
AGC Control Voltage Range	50 MHz - 1 GHz	V	0	-	+3
EIN ⁷	50 MHz - 1 GHz	pA/rtHz	-	3.2	-
Output Return Loss	50 MHz - 1 GHz	dB	-	18	-
CTB ¹⁰	79 channels	dBc	-	-68	-
CSO ¹⁰	79 channels	dBc	-	-65	-
Current	$V_{DD} = +5\text{ V}$	mA	225	260	295

4. Performance is specified using JDSU Photodiode EPM-745 or equivalent (EPM705) and output balun # MABA-009210-CT1760.
5. MACOM recommends use of a regulated supply voltage in order to limit performance variation.
6. $\text{Gain} = 20 \cdot \log(Z_T/75)$, where $Z_T = \text{Transconductance } (\Omega)$.
7. Specified at maximum gain ($V_{AGC} = +3.0\text{ V}$).
8. Positive gain slope from 50 MHz to 1 GHz (tilt of best fit straight line from 50 MHz to 1 GHz).
9. Flatness defined as peak-peak deviation from best fit straight line.
10. Optical Input Power Range: -8 dBm to +2 dBm; 79 channels:
 $P_{OUT} = +24\text{ dBmV/ch}$ at 550 MHz
 $P_{OUT} = +22.5\text{ dBmV/ch}$ at 55 MHz; +24 dBmV/ch at 550 MHz

Absolute Maximum Ratings^{11,12,13}

Parameter	Absolute Maximum
Input Power	+3 dBm Optical
Operating Voltage	+15 volts
AGC Voltage	+5 volts
Operating Temperature	-40°C to +85°C
Junction Temperature ¹⁴	+150°C
Storage Temperature	-65°C to +150°C

11. Exceeding any one or combination of these limits may cause permanent damage to this device.
12. M/A-COM Technology Solutions does not recommend sustained operation near these survivability limits.
13. Operating at nominal conditions with $T_J \leq +150^\circ\text{C}$ will ensure $MTTF > 1 \times 10^6$ hours.
14. Junction Temperature (T_J) = $T_C + \Theta_{jc} \cdot ((V \cdot I) - (P_{OUT} - P_{IN}))$
 Typical thermal resistance (Θ_{jc}) = 19° C/W.
 a) For $T_C = 25^\circ\text{C}$, $T_J = 53^\circ\text{C}$ @ 5 V, 295 mA
 b) For $T_C = 85^\circ\text{C}$, $T_J = 112^\circ\text{C}$ @ 5 V, 295 mA

Handling Procedures

Please observe the following precautions to avoid damage:

Static Sensitivity

Gallium Arsenide Integrated Circuits are sensitive to electrostatic discharge (ESD) and can be damaged by static electricity. Proper ESD control techniques should be used when handling these devices.

Recommended PCB

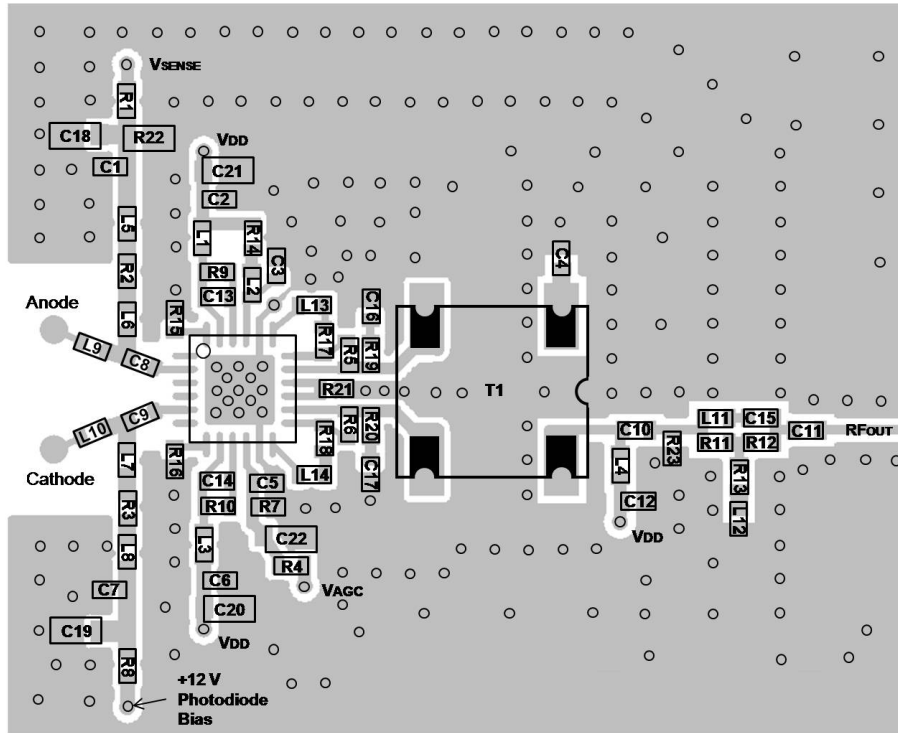

Schematic Including Off-Chip Components

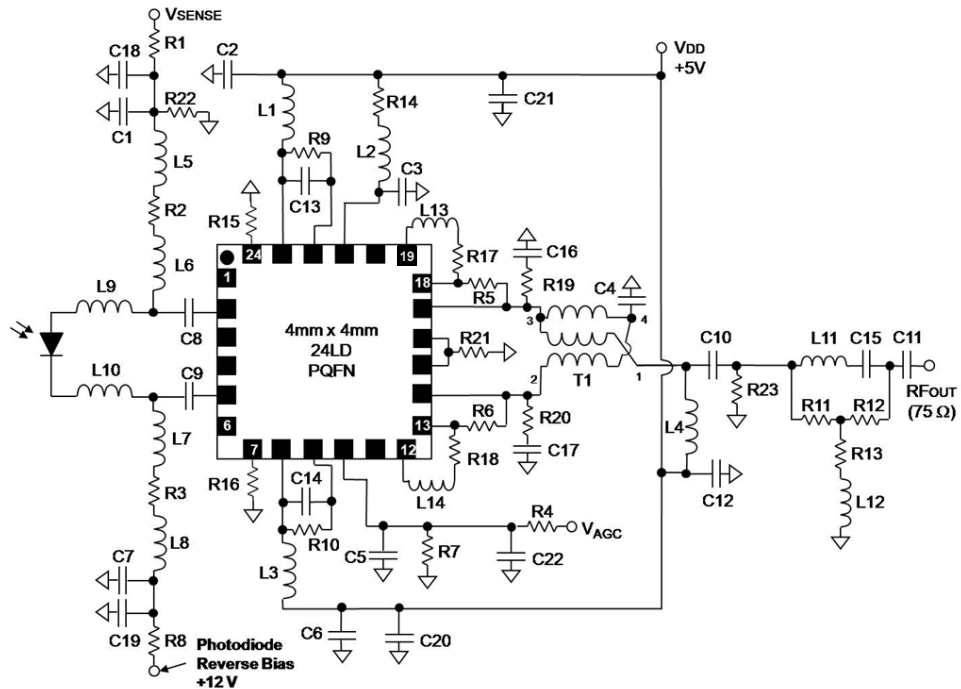

Parts List for 1GHz Matching

Component	Value	Case Style
L1 - L8 ¹⁵	Ferrite Bead	0402
L9 - L10	12 nH w/w	0402
L11	8.2 nH	0402
L12	33 nH	0402
L13 - L14	10 nH	0402
C1 - C12	10 nF	0402
C13 - C14	2.7 pF	0402
C15	3.0 pF	0402
C16 - C17	2.0 pF	0402
C18 - C22	1.0 μ F	0603
R1 - R4	1 k Ω	0402
R5 - R7	680 Ω	0402
R8	200 Ω	0402
R9 - R10	120 Ω	0402
R11 - R12	39 Ω	0402
R13	82 Ω	0402
R14	180 Ω	0402
R15 - R16	12 Ω	0402
R17 - R18	47 Ω	0402
R19 - R20	62 Ω	0402
R21	6.2 Ω	0402
R22	1 k Ω	0603
R23	470 Ω	0402
T1 ¹⁶	1:1 Balun	SM-118A

15. Ferrite Bead from Murata, part number BLM15HD182SN.

16. MACOM's MABA-009210-CT1760 1:1 T_x Line Balun.

Application Functional Schematic

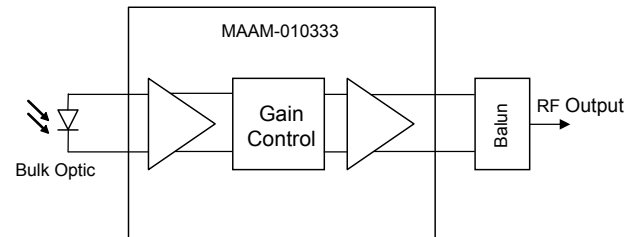

PCB Land Pattern

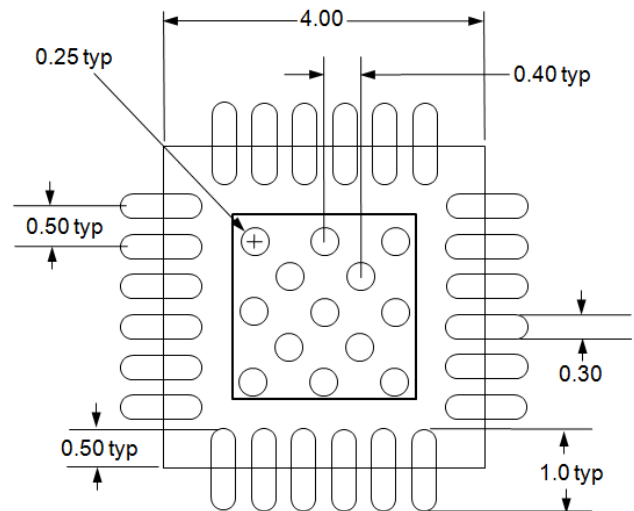

All dimension are in mm

Typical Performance Curves with 1 GHz Matching: +25°C, $V_{AGC} = 0\text{ V}$ to 3 V in 0.2 V Steps

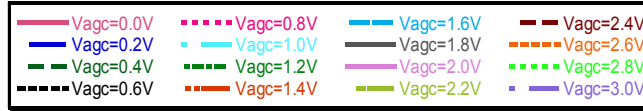

Receiver Gain vs. Frequency to 1.1 GHz

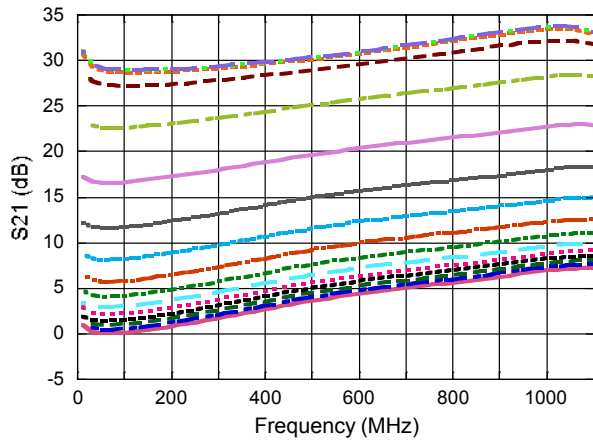

Receiver Gain vs. Frequency to 1.6 GHz

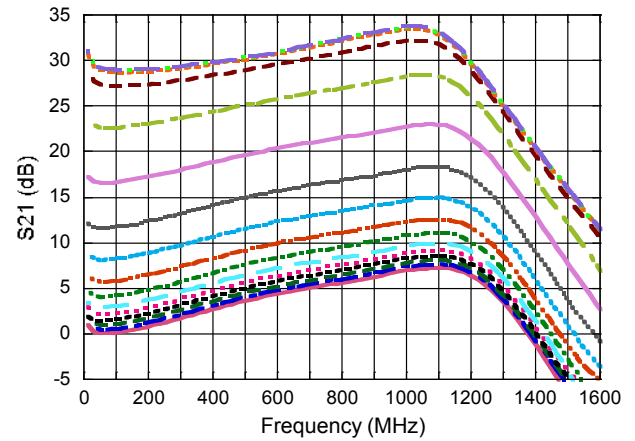

Output Return Loss vs. Frequency

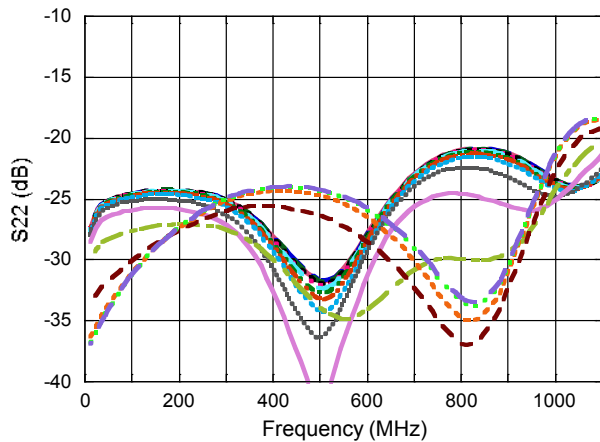

Typical Performance Curves with 1 GHz Matching: $V_{AGC} = 0\text{ V}$ to 3 V in 0.2 V Steps

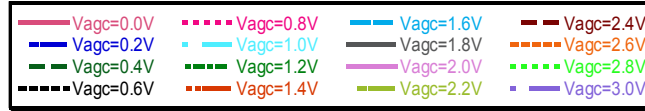

Gain Flatness Deviation From Best Fit Line @ +25°C

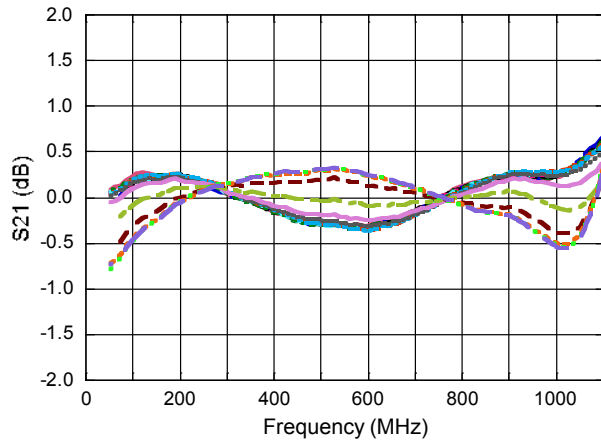

Gain Flatness Deviation From Best Fit Line @ -40°C

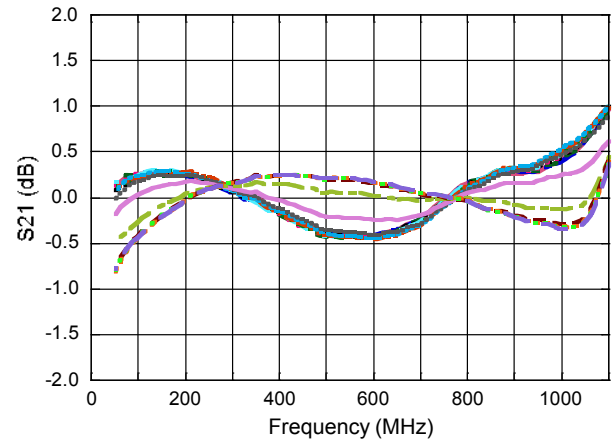

Gain Flatness Deviation From Best Fit Line @ +85°C

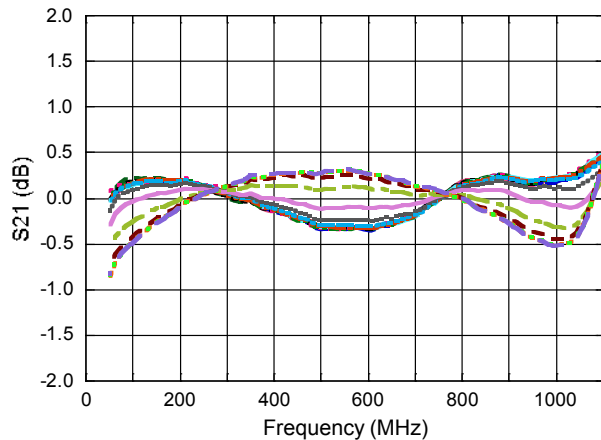

Typical Performance Curves with 1 GHz Matching:

Gain Tilt Deviation from Average Tilt

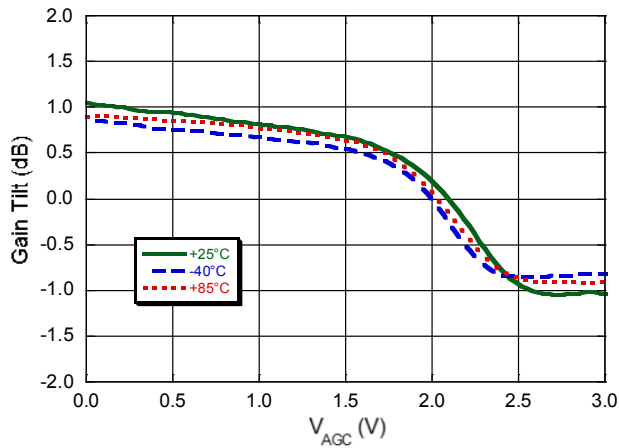

Equivalent Input Noise @ Max Gain ($V_{AGC} = 3V$)

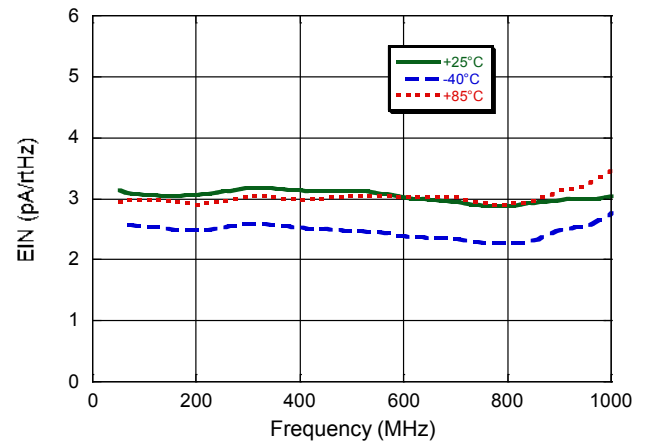

Receiver Gain vs. V_{AGC}

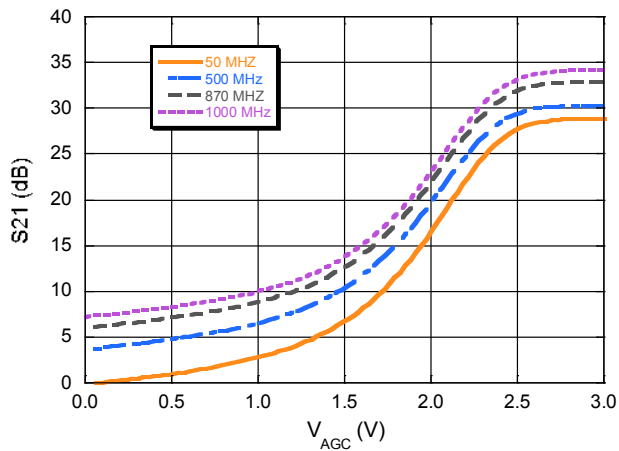

Typical Performance Curves with 1 GHz Matching:

79 Channels; NTSC Frequency Plan; $P_{out} = +22.5 \text{ dBmV/ch @ 55 MHz; } +24 \text{ dBmV @ 550 MHz}$

CTB vs. Optical Input Power

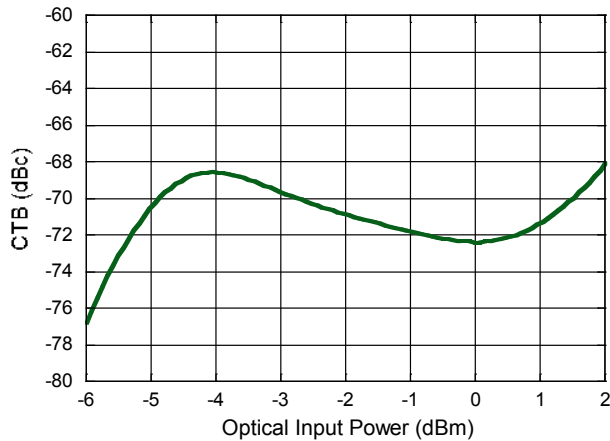

CSO_Lower vs. Optical Input Power

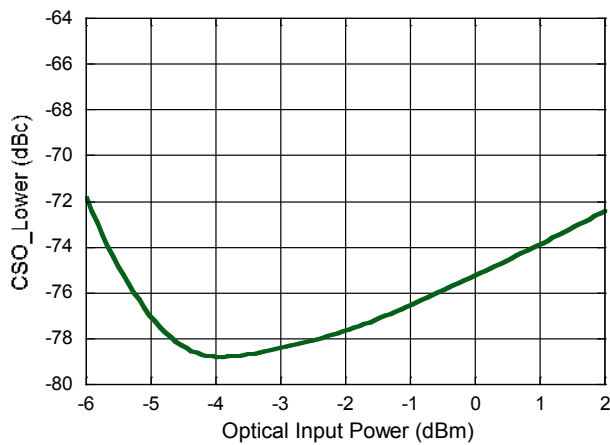

CSO_Upper vs. Optical Input Power

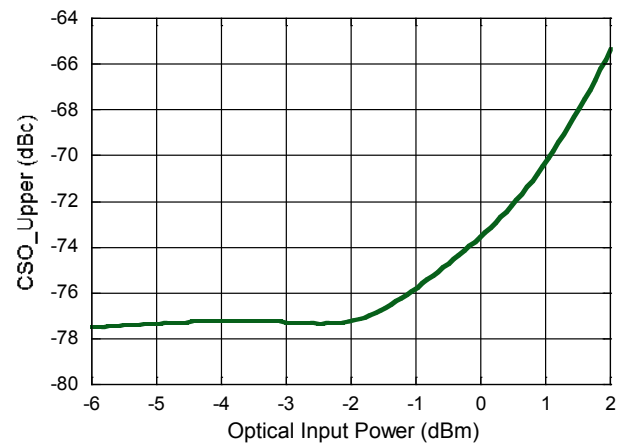

Lead Free 4 mm 24-lead PQFN¹⁷

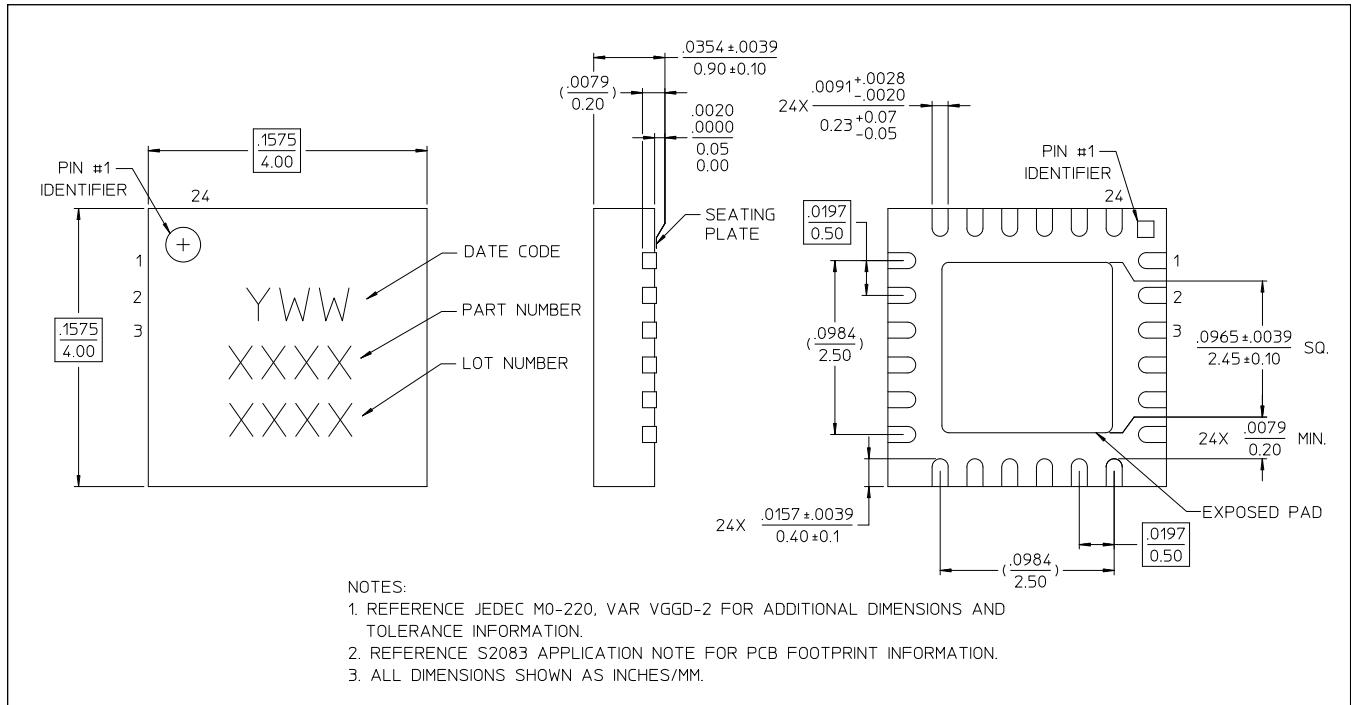

17. Reference Application Note 2083 for lead-free solder reflow recommendations.
Meets JEDEC moisture sensitivity level 1 requirements.
Plating is 100% matte tin over copper.

Application Section for 50 MHz to 1.2 GHz

Typical Performance Curves with 1.2 GHz Matching: $V_{AGC} = 0\text{ V to }3\text{ V}$ in 0.5 V Steps

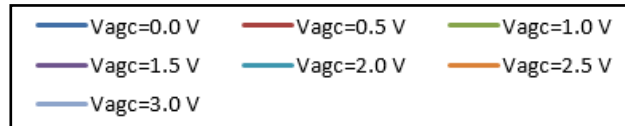

Receiver Gain

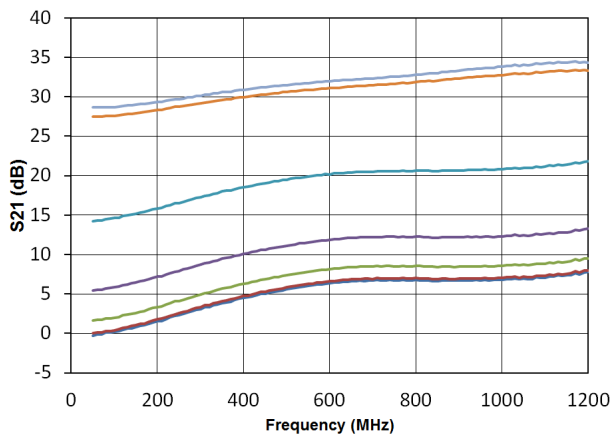

Output Return Loss

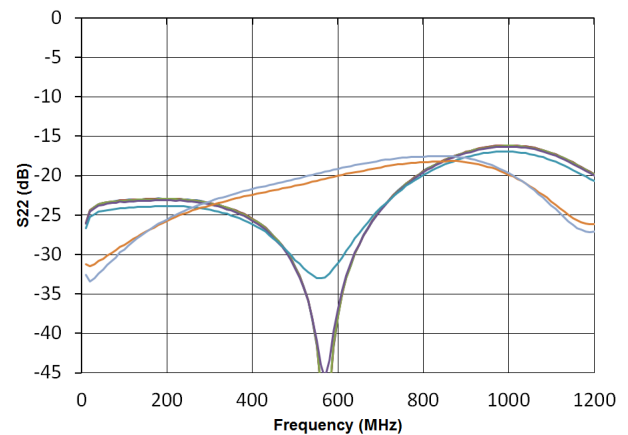

Parts List for 1.2 GHz Matching

Component	Value	Case Style	Component	Value	Case Style
L1 - L8 ¹⁸	Ferrite Bead	0402	R8	200 Ω	0402
L9 - L10	8.2 nH w/w	0402	R9 - R10	120 Ω	0402
L11	8.2 nH	0402	R11 - R12	39 Ω	0402
L12	33 nH	0402	R13	82 Ω	0402
L13 - L14	10 nH	0402	R14	180 Ω	0402
C1 - C12	10 nF	0402	R15 - R16	12 Ω	0402
C13 - C14	3.9 pF	0402	R17 - R18	47 Ω	0402
C15	3.0 pF	0402	R19 - R20	62 Ω	0402
C16 - C17	0.5 pF	0402	R21	6.2 Ω	0402
C18 - C22	1.0 μ F	0603	R22	1 k Ω	0603
R1 - R4	1 k Ω	0402	R23	470 Ω	0402
R5 - R7	680 Ω	0402	T1 ¹⁹	1:1 Balun	SM-118A

18. Ferrite Bead from Murata, part number BLM15HD182SN.

19. MACOM Technology Solutions MABA-009210-CT1760 1:1 T_x Line Balun.

MACOM Technology Solutions Inc. All rights reserved.

Information in this document is provided in connection with MACOM Technology Solutions Inc ("MACOM") products. These materials are provided by MACOM as a service to its customers and may be used for informational purposes only. Except as provided in MACOM's Terms and Conditions of Sale for such products or in any separate agreement related to this document, MACOM assumes no liability whatsoever. MACOM assumes no responsibility for errors or omissions in these materials. MACOM may make changes to specifications and product descriptions at any time, without notice. MACOM makes no commitment to update the information and shall have no responsibility whatsoever for conflicts or incompatibilities arising from future changes to its specifications and product descriptions. No license, express or implied, by estoppel or otherwise, to any intellectual property rights is granted by this document.

THESE MATERIALS ARE PROVIDED "AS IS" WITHOUT WARRANTY OF ANY KIND, EITHER EXPRESS OR IMPLIED, RELATING TO SALE AND/OR USE OF MACOM PRODUCTS INCLUDING LIABILITY OR WARRANTIES RELATING TO FITNESS FOR A PARTICULAR PURPOSE, CONSEQUENTIAL OR INCIDENTAL DAMAGES, MERCHANTABILITY, OR INFRINGEMENT OF ANY PATENT, COPYRIGHT OR OTHER INTELLECTUAL PROPERTY RIGHT. MACOM FURTHER DOES NOT WARRANT THE ACCURACY OR COMPLETENESS OF THE INFORMATION, TEXT, GRAPHICS OR OTHER ITEMS CONTAINED WITHIN THESE MATERIALS. MACOM SHALL NOT BE LIABLE FOR ANY SPECIAL, INDIRECT, INCIDENTAL, OR CONSEQUENTIAL DAMAGES, INCLUDING WITHOUT LIMITATION, LOST REVENUES OR LOST PROFITS, WHICH MAY RESULT FROM THE USE OF THESE MATERIALS.

MACOM products are not intended for use in medical, lifesaving or life sustaining applications. MACOM customers using or selling MACOM products for use in such applications do so at their own risk and agree to fully indemnify MACOM for any damages resulting from such improper use or sale.