

HLMP-Cxxx

T-1³/₄ (5 mm) Extra Bright Precision Optical
Performance InGaN LED Lamps



Data Sheet

**HLMP-CB11, HLMP-CB12, HLMP-CM11,
HLMP-CM12, HLMP-CE11, HLMP-CE12,
HLMP-CB26, HLMP-CB27, HLMP-CM26,
HLMP-CM27, HLMP-CE26, HLMP-CE27,
HLMP-CB36, HLMP-CB37, HLMP-CM36,
HLMP-CM37, HLMP-CE36, HLMP-CE37**

Description

These high intensity blue, green, and cyan LEDs are based on the most efficient and cost effective InGaN material technology. The 470 nm typical dominant wavelength for blue and 525 nm typical wavelength for green is well suited to color mixing in full color signs. The 505 nm typical dominant wavelength for cyan is suitable for traffic signal application.

These LED lamps are untinted, non-diffused, T-13/4 packages incorporating second generation optics which produce well-defined spatial radiation patterns at specific viewing cone angles.

These lamps are made with an advanced optical grade epoxy, offering superior temperature and moisture resistance in outdoor signal and sign applications. The high maximum LED junction temperature limit of +110°C enables high temperature operation in bright sunlight conditions.

Features

- Well defined spatial radiation pattern
- High luminous output
- Available in blue, green, and cyan color
- Viewing angle: 15°, 23° and 30°
- Standoff or non-standoff leads
- Superior resistance to moisture

Applications

- Traffic signals
- Commercial outdoor advertising
- Front panel backlighting
- Front panel indicator

CAUTION: Devices are Class 1C ESD sensitive. Please observe appropriate precautions during handling and processing. Refer to Application Note AN-1142 for additional details.

Device Selection Guide

Part Number	Color	Typical Viewing Angle, $2\theta_{1/2}$ (Degree)	Intensity (cd) at 20 mA		Standoff	Package	
			Min.	Max.		Dimension	Lens
HLMP-CB11-TW0xx	Blue	15	2.5	7.2	No	A	Clear
HLMP-CB11-UVBxx	Blue	15	3.2	5.5	No	A	Clear
HLMP-CB12-TW0xx	Blue	15	2.5	7.2	Yes	B	Clear
HLMP-CM11-Y20xx	Green	15	9.3	27.0	No	A	Clear
HLMP-CM11-Z1Cxx	Green	15	12.0	21.0	No	A	Clear
HLMP-CM12-Y20xx	Green	15	9.3	27.0	Yes	B	Clear
HLMP-CE11-X10xx	Cyan	15	7.2	21.0	No	A	Clear
HLMP-CE12-X10xx	Cyan	15	7.2	21.0	Yes	B	Clear
HLMP-CB26-SV0xx	Blue	23	1.9	5.5	No	A	Clear
HLMP-CB26-TUDxx	Blue	23	2.5	4.2	No	A	Clear
HLMP-CB27-SV0xx	Blue	23	1.9	5.5	Yes	B	Clear
HLMP-CM26-X10xx	Green	23	7.2	21.0	No	A	Clear
HLMP-CM26-YZCxx	Green	23	9.3	16.0	No	A	Clear
HLMP-CM27-X10xx	Green	23	7.2	21.0	Yes	B	Clear
HLMP-CE26-WZ0xx	Cyan	23	5.5	16.0	No	A	Clear
HLMP-CE27-WZ0xx	Cyan	23	5.5	16.0	Yes	B	Clear
HLMP-CB36-QT0xx	Blue	30	1.15	3.2	No	A	Clear
HLMP-CB36-RSBxx	Blue	30	1.5	2.5	No	A	Clear
HLMP-CB37-RU0xx	Blue	30	1.5	4.2	Yes	B	Clear
HLMP-CB37-RSDxx	Blue	30	1.5	2.5	Yes	B	Clear
HLMP-CM36-X10xx	Green	30	7.2	21.0	No	A	Clear
HLMP-CM36-XYCxx	Green	30	7.2	12.0	No	A	Clear
HLMP-CM37-X10xx	Green	30	7.2	21.0	Yes	B	Clear
HLMP-CM37-XYCxx	Green	30	7.2	12.0	Yes	B	Clear
HLMP-CM37-XYDxx	Green	30	7.2	12.0	Yes	B	Clear
HLMP-CE36-WZ0xx	Cyan	30	5.5	16.0	No	A	Clear
HLMP-CE37-WZ0xx	Cyan	30	5.5	16.0	Yes	B	Clear

Notes:

1. Tolerance for luminous intensity measurement is $\pm 15\%$.
2. The luminous intensity is measured on the mechanical axis of the lamp package.
3. The optical axis is closely aligned with the package mechanical axis.
4. LED light output is bright enough to cause injuries to the eyes. Precautions must be taken to prevent looking directly at the LED without proper safety equipment.
5. $2\theta_{1/2}$ is the off-axis angle where the luminous intensity is 1/2 the on-axis intensity.

Part Numbering System

HLMP - x x xx - x x x xx

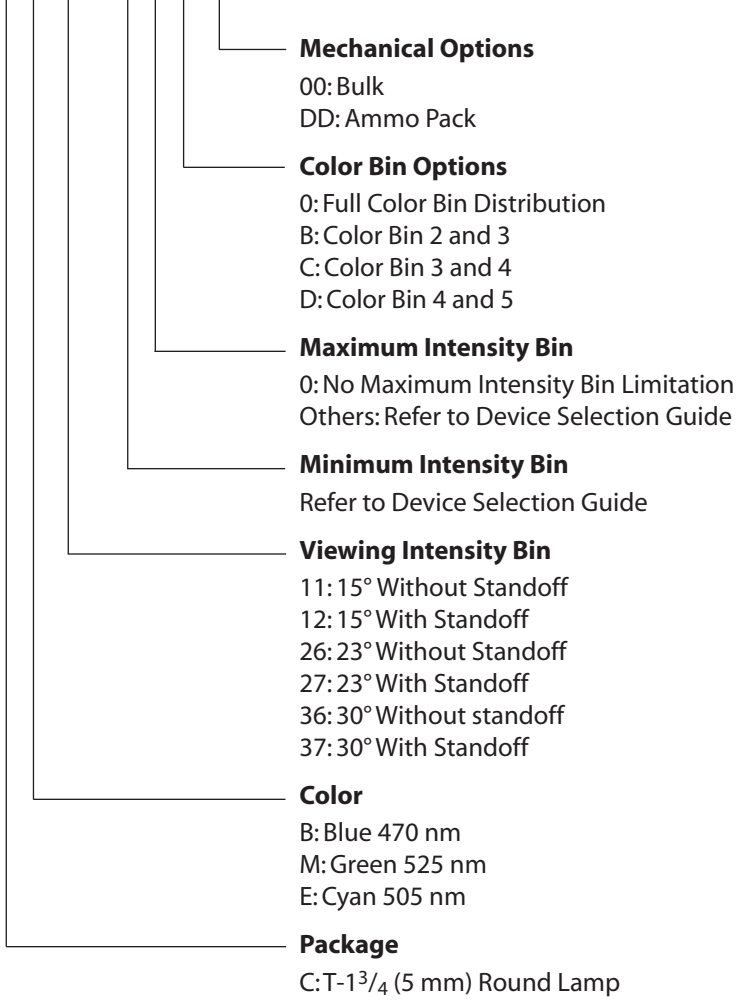

Absolute Maximum Rating at $T_A = 25^\circ\text{C}$

Parameters	Value	Unit
DC Forward Current ^[1]	30	mA
Peak Pulsed Forward Current ^[2]	100	mA
Power Dissipation	116	mW
LED Junction Temperature	130	$^\circ\text{C}$
Operating Temperature Range	-40 to +85	$^\circ\text{C}$
Storage Temperature Range	-40 to +100	$^\circ\text{C}$

Notes:

1. Derate linearly as shown in Figure 2.
2. Duty factor 10%, frequency 1 KHz.

Electrical/Optical Characteristics

$T_A = 25^\circ\text{C}$

Parameters	Symbol	Blue			Green			Cyan			Units	Test Condition
		Min.	Typ.	Max.	Min.	Typ.	Max.	Min.	Typ.	Max.		
Forward Voltage	V_F	3.2	3.85		3.3	3.85		3.2	3.85		V	$I_F = 20\text{ mA}$
Reverse Voltage ^[1]	V_R	5.0			5.0			5.0			V	$I_R = 10\ \mu\text{A}$
Thermal Resistance	$R\theta_{J-PIN}$	240			240			240			$^\circ\text{C}/\text{W}$	LED Junction to Anode Lead
Dominant Wavelength ^[2]	λ_d	460	470	480	520	525	540	490	505	508	nm	$I_F = 20\text{ mA}$
Peak Wavelength	λ_{PEAK}	464			516			501			nm	Peak of Wavelength of Spectral Distribution at $I_F = 20\text{ mA}$
Spectral Half Width	$\Delta\lambda_{1/2}$	23			32			30			nm	Wavelength Width at Spectral Distribution Power Point at $I_F = 20\text{ mA}$
Luminous Efficacy ^[3]	η_v	74			484			319			lm/W	Emitted Luminous Power/Emitted Radiant Power

Notes:

1. The reverse voltage of the product is equivalent to the forward voltage of the protective chip at $I_R = 10\ \mu\text{A}$.
2. The dominant wavelength, λ_d , is derived from the Chromaticity Diagram and represents the color of the lamp.
3. The radiant intensity, I_e in watts/steradian, may be found from the equation $I_e = I_v/\eta_v$, where I_v is the luminous intensity in candelas and η_v is the luminous efficacy in lumens/watt.

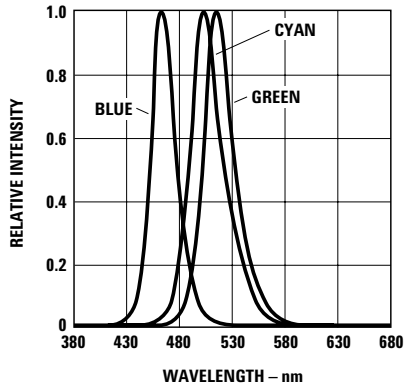

Figure 1. Relative intensity vs. wavelength

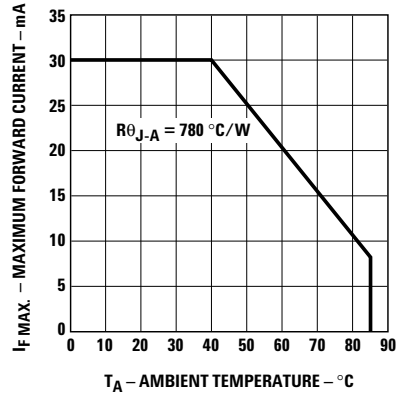

Figure 2. Forward current vs. ambient temperature

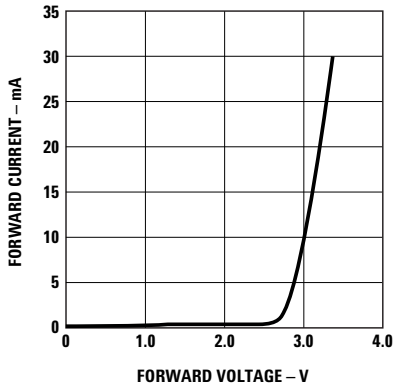

Figure 3. Forward current vs. forward voltage

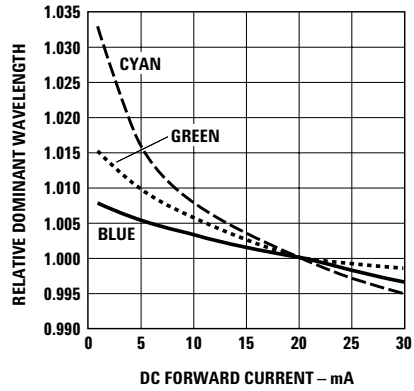

Figure 4. Relative dominant wavelength vs. DC forward current

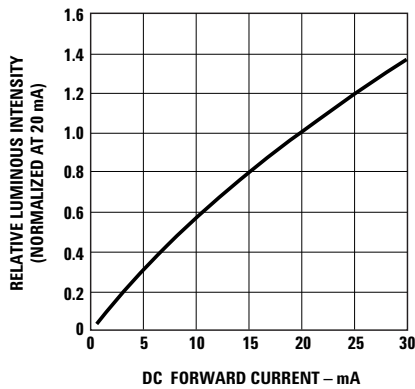

Figure 5. Relative intensity vs. DC forward current

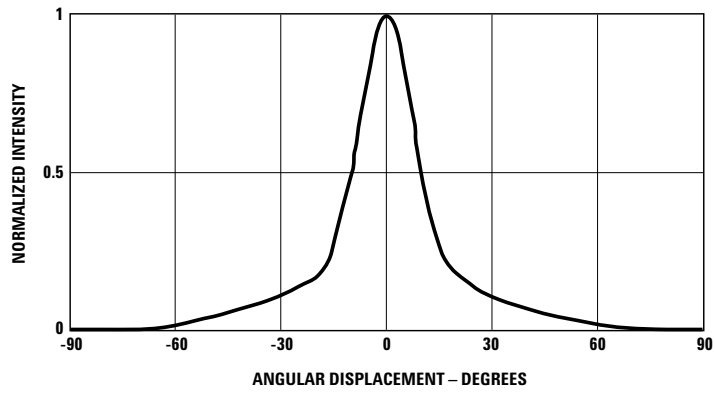

Figure 6. Spatial radiation pattern for Cx11 and Cx12

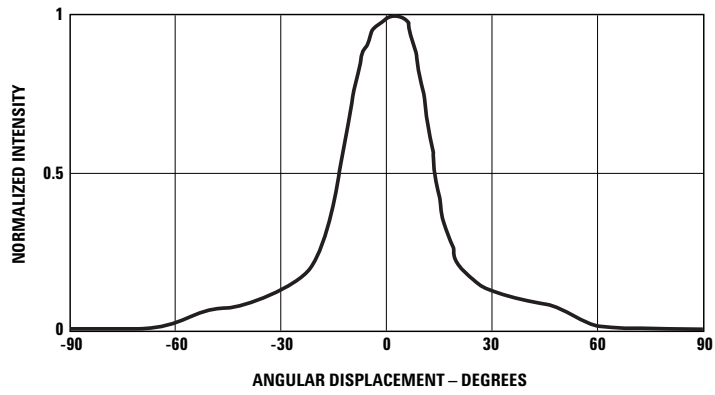

Figure 7. Spatial radiation pattern for Cx26 and Cx27

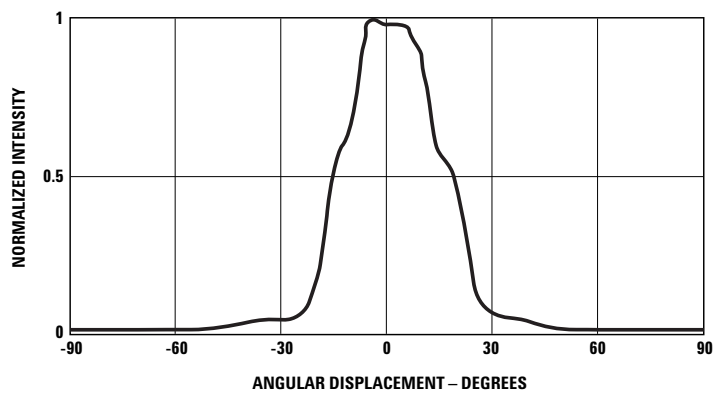

Figure 8. Spatial radiation pattern for Cx36 and Cx37

Intensity Bin Limit Table

Bin	Intensity (mcd) at 20 mA	
	Min	Max
N	680	880
P	880	1150
Q	1150	1500
R	1500	1900
S	1900	2500
T	2500	3200
U	3200	4200
V	4200	5500
W	5500	7200
X	7200	9300
Y	9300	12000
Z	12000	16000
1	16000	21000

Tolerance for each bin limit is $\pm 15\%$.

Blue Color Bin Table

Bin	Min Dom	Max Dom	Xmin	Ymin	Xmax	Ymax
1	460.0	464.0	0.1440	0.0297	0.1766	0.0966
			0.1818	0.0904	0.1374	0.0374
2	464.0	468.0	0.1374	0.0374	0.1699	0.1062
			0.1766	0.0966	0.1291	0.0495
3	468.0	472.0	0.1291	0.0495	0.1616	0.1209
			0.1699	0.1062	0.1187	0.0671
4	472.0	476.0	0.1187	0.0671	0.1517	0.1423
			0.1616	0.1209	0.1063	0.0945
5	476.0	480.0	0.1063	0.0945	0.1397	0.1728
			0.1517	0.1423	0.0913	0.1327

Tolerance for each bin limit is ± 0.5 nm.

Green Color Bin Table

Bin	Min Dom	Max Dom	Xmin	Ymin	Xmax	Ymax
1	520.0	524.0	0.0743	0.8338	0.1856	0.6556
			0.1650	0.6586	0.1060	0.8292
2	524.0	528.0	0.1060	0.8292	0.2068	0.6463
			0.1856	0.6556	0.1387	0.8148
3	528.0	532.0	0.1387	0.8148	0.2273	0.6344
			0.2068	0.6463	0.1702	0.7965
4	532.0	536.0	0.1702	0.7965	0.2469	0.6213
			0.2273	0.6344	0.2003	0.7764
5	536.0	540.0	0.2003	0.7764	0.2659	0.6070
			0.2469	0.6213	0.2296	0.7543

Tolerance for each bin limit is ± 0.5 nm.

Cyan Color Bin Table

Bin	Min Dom	Max Dom	Xmin	Ymin	Xmax	Ymax
1	490.0	495.0	0.0454	0.2945	0.1164	0.3889
			0.1318	0.306	0.0235	0.4127
2	495.0	500.0	0.0345	0.4127	0.1057	0.4769
			0.1164	0.3889	0.0082	0.5384
3	500.0	505.0	0.0082	0.5384	0.1027	0.5584
			0.1057	0.4769	0.0039	0.6548
4	505.0	510.0	0.0039	0.6548	0.1097	0.6251
			0.1027	0.5584	0.0139	0.7502
7	498.0	503.0	0.0132	0.4882	0.1028	0.5273
			0.1092	0.4417	0.0040	0.6104
8	503.0	508.0	0.0040	0.6104	0.1056	0.6007
			0.1028	0.5273	0.0080	0.7153

Tolerance for each bin limit is ± 0.5 nm.

Precautions

Lead Forming

- The leads of an LED lamp may be preformed or cut to length prior to insertion and soldering on PC board.
- If lead forming is required before soldering, care must be taken to avoid any excessive mechanical stress induced into the LED package. Otherwise, cut the leads to applicable length after soldering process at room temperature. The solder joint formed will absorb the mechanical stress, due to lead cutting, from traveling to the LED chip die attach and wirebond.
- For better control, it is recommended to use proper tool to precisely form and cut the leads to applicable length rather than doing it manually.

Soldering Conditions

- Care must be taken during PCB assembly and soldering process to prevent damage to LED component.
- The closest manual soldering distance of the soldering heat source (soldering iron's tip) to the body is 1.59 mm. Soldering the LED closer than 1.59 mm might damage the LED.

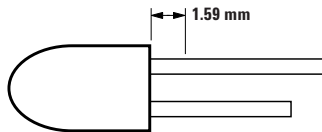

- Recommended soldering conditions:

	Wave Soldering	Manual Solder Dipping
Pre-heat Temperature	105 °C Max.	–
Pre-heat Time	30 sec Max.	–
Peak Temperature	250 °C Max.	260 °C Max.
Dwell Time	3 sec Max.	5 sec Max.

- Wave soldering parameter must be set and maintained according to recommended temperature and dwell time in the solder wave. Customer is advised to daily check on the soldering profile to ensure the soldering profile is always conforming to recommended soldering condition.

Notes:

1. PCB with different size and design (component density) will have different heat mass (heat capacity). This might cause a change in temperature experienced by the board if samewave soldering setting is used. So, it is recommended to recalibrate the soldering profile again before loading a new type of PCB.
2. Avago Technologies' high brightness LEDs use a high efficiency LED die with single wire bond, as shown below. Customer is advised to take extra precaution during wave soldering to ensure that the maximum wave temperature does not exceed 250°C. Over-stressing the LED during soldering process might cause premature failure to the LED due to delamination.

Avago Technologies LED Configuration

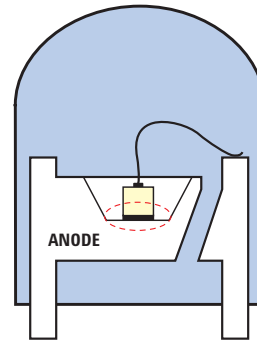

InGaN Device

Note: Electrical connection between bottom surface of LED die and the lead frame material through conductive paste of solder.

- If necessary, use fixture to hold the LED component in proper orientation with respect to the PCB during soldering process.
- At elevated temperature, the LED is more susceptible to mechanical stress. Therefore, PCB must be allowed to cool down to room temperature prior to handling, which includes removal of jigs, fixtures or pallet.
- Special attention must be given to board fabrication, solder masking, surface plating and lead holes size and component orientation to assure solderability.
- Recommended PC board plated through hole sizes for LED component leads:

LED Component Lead Size	Diagonal	Plated Through Hole Diameter
0.457 x 0.457 mm (0.018 x 0.018 inch)	0.646 mm (0.025 inch)	0.976 to 1.078 mm (0.038 to 0.042 inch)
0.508 x 0.508 mm (0.020 x 0.020 inch)	0.718 mm (0.028 inch)	1.049 to 1.150 mm (0.041 to 0.045 inch)

- Over sizing of plated through hole can lead to twisting or improper LED placement during auto insertion. Under sizing plated through hole can lead to mechanical stress on the epoxy lens during clinching.

Note: Refer to application note AN1027 for more information on soldering LED components.

Recommended Wave Soldering Profile

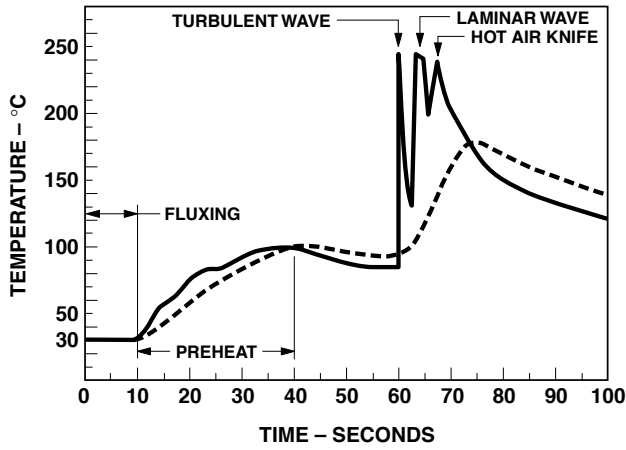

— BOTTOM SIDE OF PC BOARD
 - - - TOP SIDE OF PC BOARD

CONVEYOR SPEED = 1.83 M/MIN (6 FT/MIN)
 PREHEAT SETTING = 150°C (100°C PCB)
 SOLDER WAVE TEMPERATURE = 245°C ± 5°C
 AIR KNIFE AIR TEMPERATURE = 390°C
 AIR KNIFE DISTANCE = 1.91 mm (0.25 IN.)
 AIR KNIFE ANGLE = 40°
 SOLDER: SN63; FLUX: RMA
 LEAD-FREE SOLDER: 96.5% Sn; 3% Ag; 0.5% Cu

NOTE: ALLOW FOR BOARDS TO BE SUFFICIENTLY COOLED BEFORE EXERTING MECHANICAL FORCE.

Ammo Packs Drawing

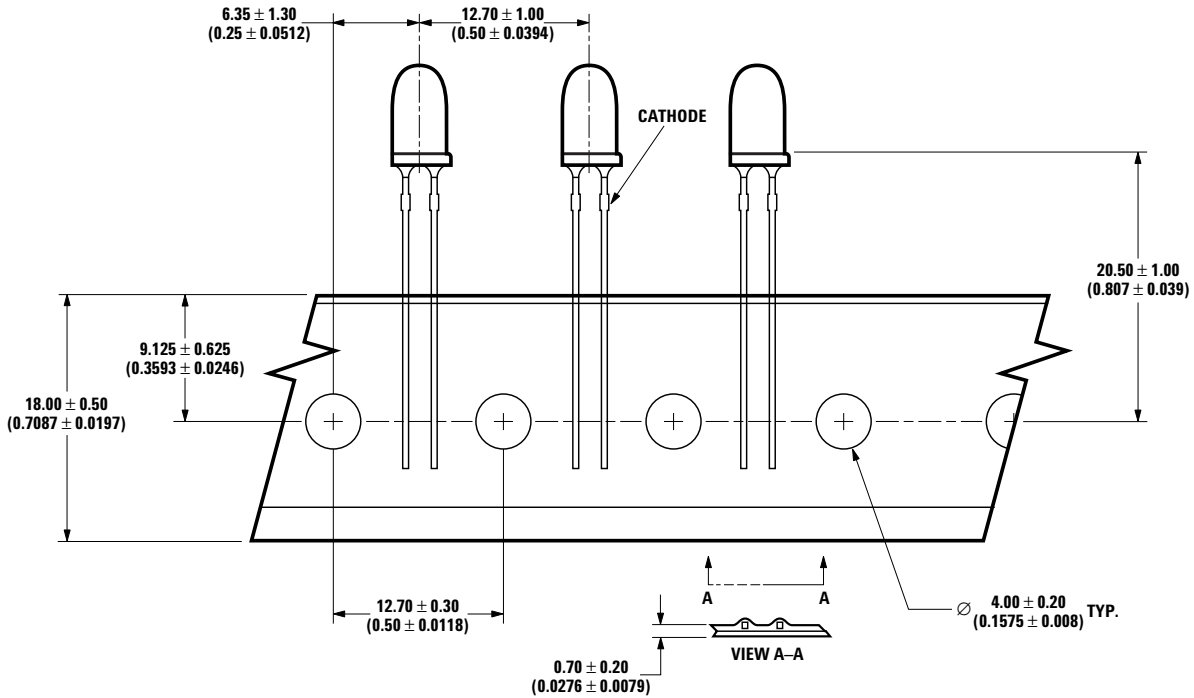

ALL DIMENSIONS IN MILLIMETERS (INCHES).

NOTE: THE AMMO-PACKS DRAWING IS APPLICABLE FOR PACKAGING OPTION -DD & -ZZ AND REGARDLESS OF STANDOFF OR NON-STANDOFF.

Packaging Box for Ammo Packs

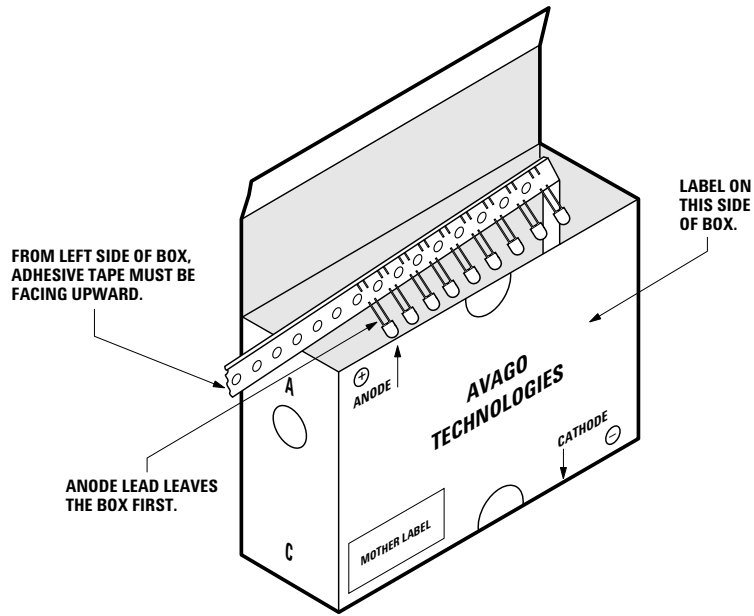

NOTE:
FOR InGaN DEVICE, THE AMMO PACK PACKAGING BOX CONTAINS ESD LOGO.

DISCLAIMER

AVAGO'S PRODUCTS AND SOFTWARE ARE NOT SPECIFICALLY DESIGNED, MANUFACTURED OR AUTHORIZED FOR SALE AS PARTS, COMPONENTS OR ASSEMBLIES FOR THE PLANNING, CONSTRUCTION, MAINTENANCE OR DIRECT OPERATION OF A NUCLEAR FACILITY OR FOR USE IN MEDICAL DEVICES OR APPLICATIONS. CUSTOMER IS SOLELY RESPONSIBLE, AND WAIVES ALL RIGHTS TO MAKE CLAIMS AGAINST AVAGO OR ITS SUPPLIERS, FOR ALL LOSS DAMAGE, EXPENSE OR LIABILITY IN CONNECTION WITH SUCH USE.

For product information and a complete list of distributors, please go to our website: www.avagotech.com

Avago, Avago Technologies, and the A logo are trademarks of Avago Technologies Limited in the United States and other countries.
Data subject to change. Copyright © 2008 Avago Technologies Limited. All rights reserved. Obsoletes 5989-4115EN
AV02-0367EN March 6, 2008

AVAGO
TECHNOLOGIES