



PART NAME

NEMA DIE CAST ALUM. ENCLOSURE w/MTG. BRKT.

PART No.

AN-2863-A & AN-2863-AB

REVISION DATE

9-30-15

UL LISTED FOR U.S. AND CANADA - FILE #E194432

UPDATE REPLACES PART NO. AN-2863 & AN-2863-B

**DRAWING FOR REFERENCE**  
WE RESERVE THE RIGHT TO MAKE CHANGES TO OUR STANDARD PRODUCTS. PLEASE CONSULT WITH BUD INDUSTRIES PRIOR TO USING THIS DRAWING FOR DESIGN PURPOSE.

TYPE RATING 4, 4X, 6, 6P, 12 AND 13, COMPARE TO IP-68

80°C. MAXIMUM OPERATING TEMPERATURE

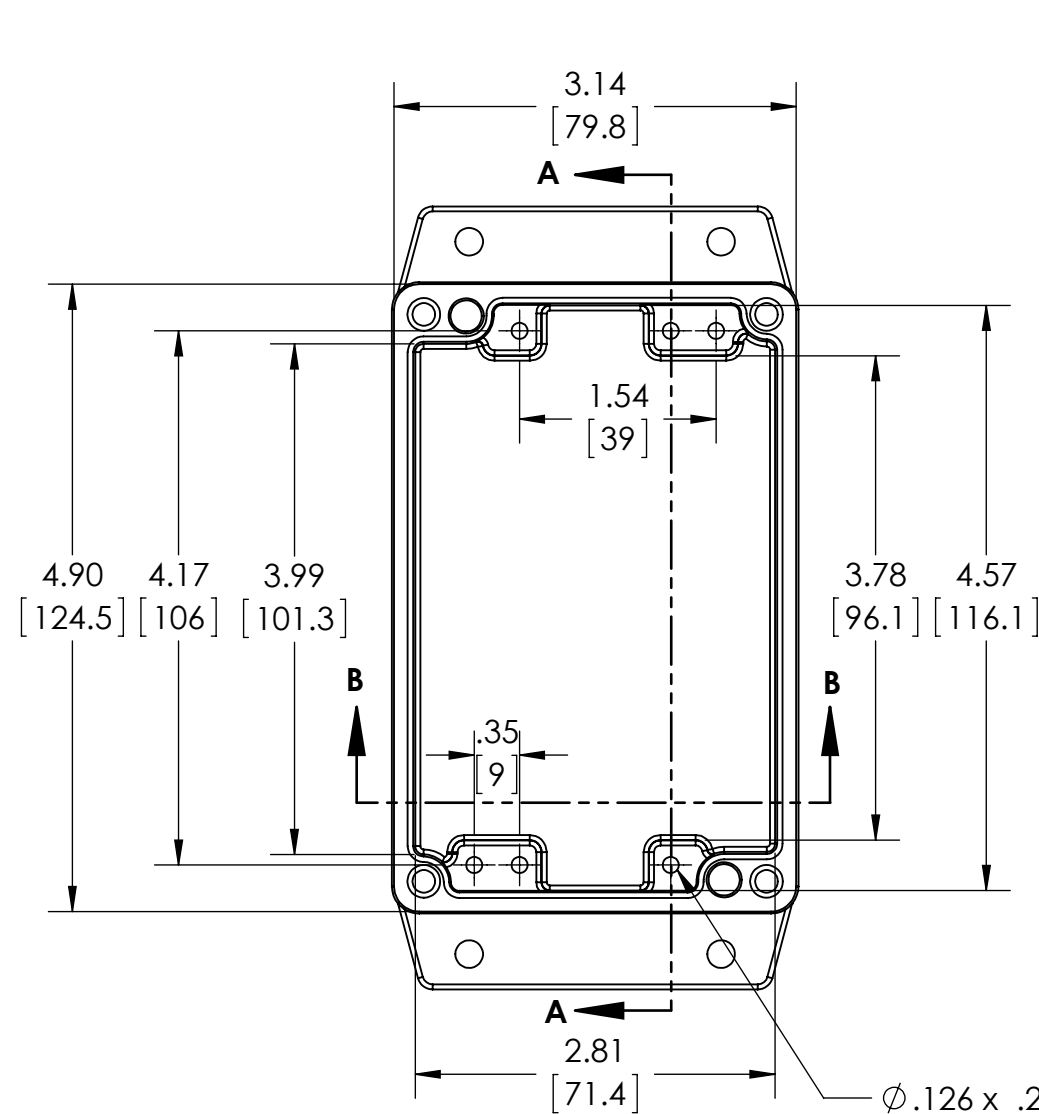

**BODY COVER NOT SHOWN**

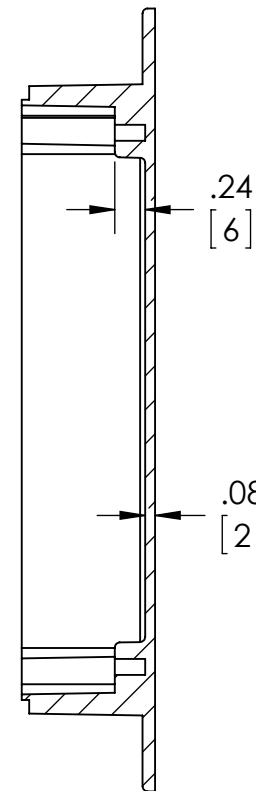

**SECTION A-A**

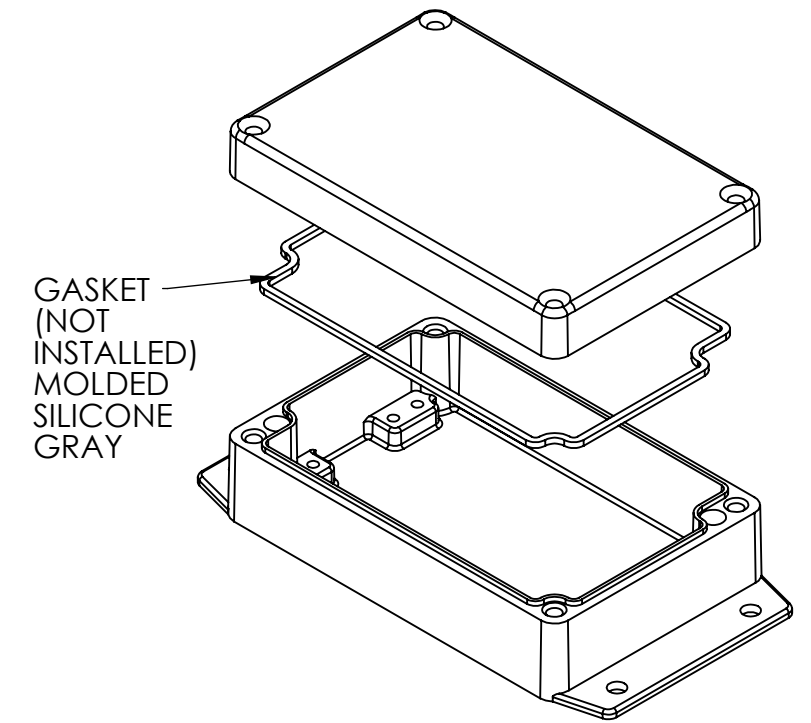
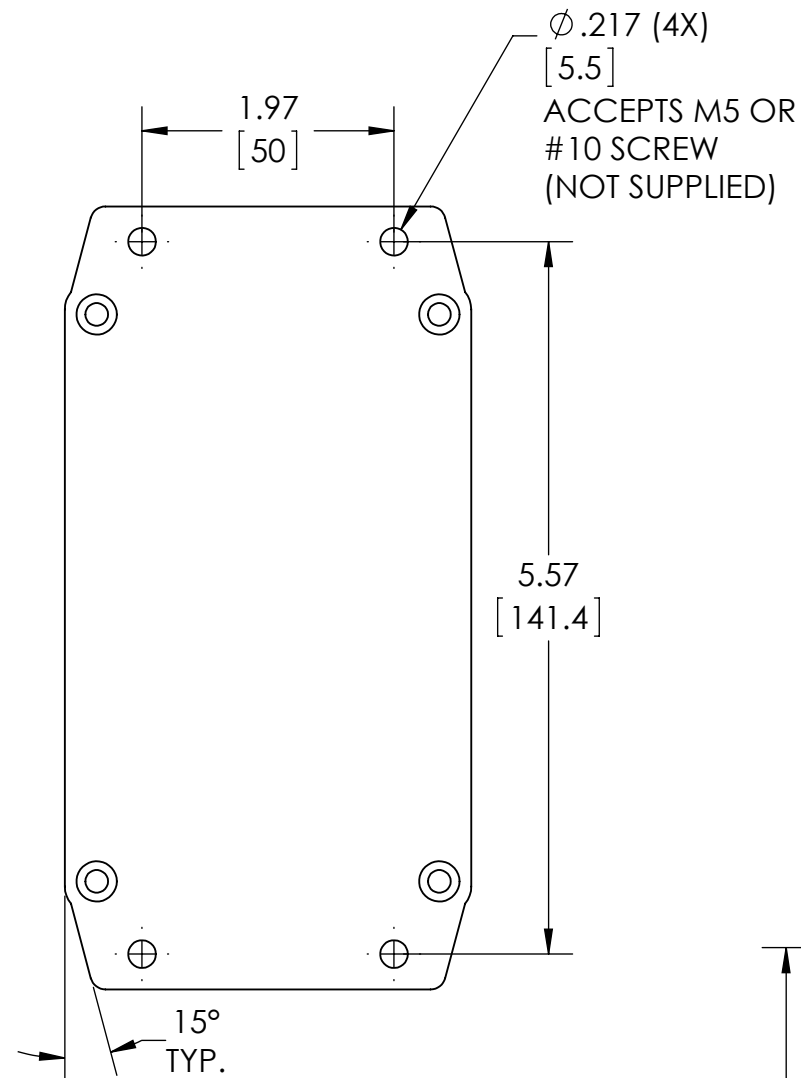

GASKET (NOT INSTALLED) MOLDED SILICONE GRAY

Ø.126 x .236 DEEP (6X) [3.2] [6]  
ACCEPTS M3.5 x 6mm LG. OR #6 x 1/4" LG. SELF-TAPPING SCREW (NOT SUPPLIED - FOR PCB MOUNTING)

MATERIAL: BODY & COVER - ALUMINUM ALLOY #ADC-12

FINISH: NATURAL (SUFFIX -A)  
SMOOTH BLACK POWDERCOAT (SUFFIX -AB)

FOUR (4) M4x0.7 x 25mm (.98") LG. 90° CSK. HEAD STAINLESS STEEL SCREWS SUPPLIED FOR ASSEMBLY OF COVER TO BODY. APPLY AT 12 IN./LB. OF TORQUE.

OUTSIDE DRAFT ANGLE: 1°  
INSIDE DRAFT ANGLE: 1/2°  
DIMENSIONS ARE INCH[MM]

OPTIONAL ACCESSORIES:  
PCB MOUNTING KIT #57-58  
INTERNAL PANEL #ANX-91313  
REPLACEMENT GASKET #1313GSKTSC

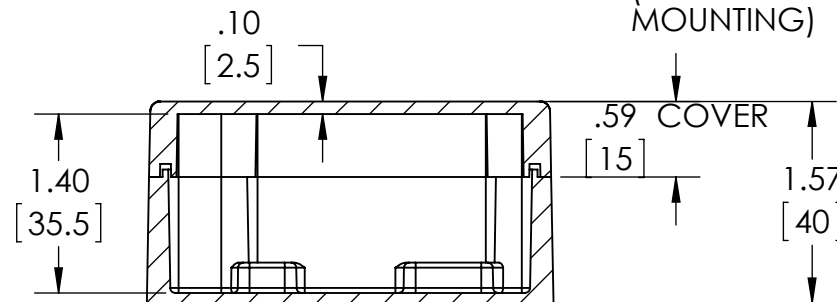

**SECTION B-B**

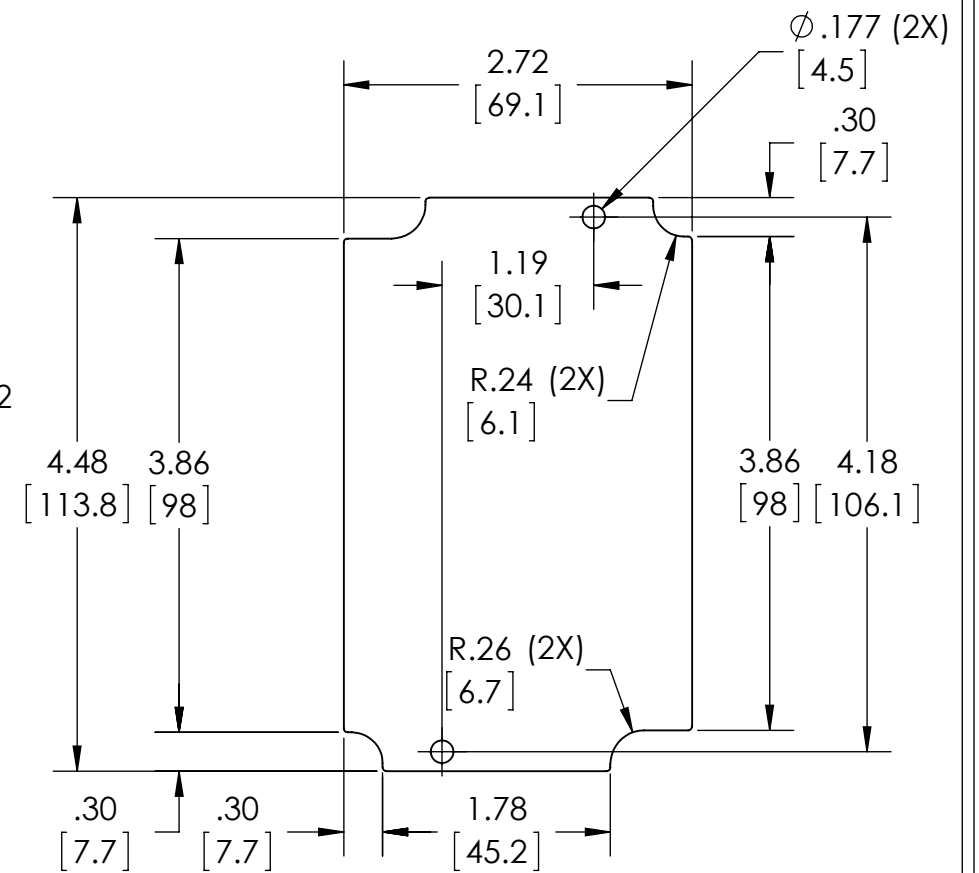

**OPTIONAL INTERNAL PANEL AND SUGGESTED PC BOARD LAYOUT**