

3A, 17V Current Mode Synchronous Step-Down Converter

General Description

The RT7296C is a high-efficiency, 3A current mode synchronous step-down DC/DC converter with a wide input voltage range from 4.5V to 17V. The device integrates 80mΩ high-side and 30mΩ low-side MOSFETs to achieve high efficiency conversion. The current mode control architecture supports fast transient response and internal compensation. A cycle-by-cycle current limit function provides protection against shorted output. The RT7296C provides complete protection functions such as input under-voltage lockout, output under-voltage protection, over-current protection, and thermal shutdown. The PWM frequency is adjustable by the EN/SYNC pin. The RT7296C is available in the TSOT-23-8 (FC) package.

Ordering Information

RT7296C □ □

- Package Type
J8F : TSOT-23-8 (FC)
- Lead Plating System
G : Green (Halogen Free and Pb Free)

Note :

Richtek products are :

- ▶ RoHS compliant and compatible with the current requirements of IPC/JEDEC J-STD-020.
- ▶ Suitable for use in SnPb or Pb-free soldering processes.

Features

- 4.5V to 17V Input Voltage Range
- 3A Output Current
- Internal N-Channel MOSFETs
- Current Mode Control
- Fixed Switching Frequency : 1.4MHz
- Synchronous to External Clock : 300kHz to 3MHz
- Cycle-by-Cycle Current Limit
- External Soft-Start Function
- Input Under-Voltage Lockout
- Output Under-Voltage Protection
- Thermal Shutdown

Applications

- Industrial and Commercial Low Power Systems
- Computer Peripherals
- LCD Monitors and TVs
- Set-top Boxes

Marking Information

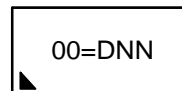

00= : Product Code
DNN : Date Code

Simplified Application Circuit

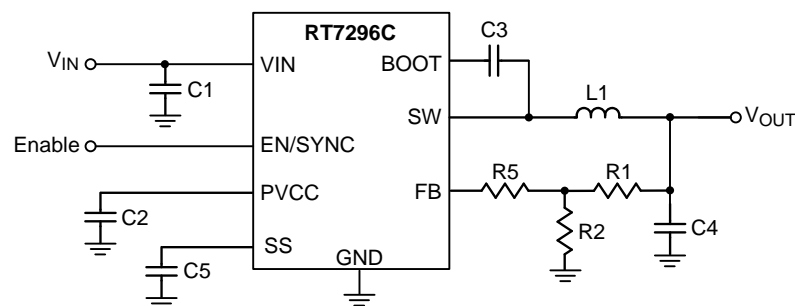

Pin Configurations

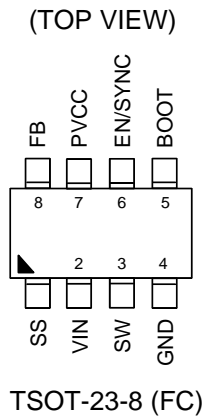

Functional Pin Description

Pin No.	Pin Name	Pin Function
1	SS	Soft-Start Control Input. SS control the soft-start period. Connect a capacitor from SS to GND to set the soft-start period.
2	VIN	Power Input. Support 4.5V to 17V Input Voltage. Must bypass with a suitable large ceramic capacitor at this pin.
3	SW	Switch Node. Connect to external L-C filter.
4	GND	System Ground.
5	BOOT	Bootstrap Supply for High-Side Gate Driver. Connect a 0.1 μ F ceramic capacitor between the BOOT and SW pins.
6	EN/SYNC	Enable Control Input. High = Enable. Apply an external clock to adjust the switching frequency. If using pull high resistor connected to VIN, the recommended value range is 60k Ω to 300k Ω .
7	PVCC	5V Bias Supply Output. Connect a minimum of 0.1 μ F capacitor to ground.
8	FB	Feedback Voltage Input. The pin is used to set the output voltage of the converter to regulate to the desired voltage via a resistive divider. Feedback reference = 0.8V.

soft-start timing can be programmed by the external capacitor between SS pin and GND. The Chip provides a 11 μ A charge current for the external capacitor.

Over Current Protection

RT7296C provides cycle-by-cycle over current limit protection. When the inductor current peak value reaches current limit, IC will turn off High Side MOS to avoid over current.

Under Voltage Protection (Hiccup Mode)

RT7296C provides Hiccup Mode of Under Voltage Protection (UVP). When the FB voltage drops below half of the feedback reference voltage, V_{FB} , the UVP function will be triggered and the IC will shut down for a period of time and then recover automatically. The Hiccup Mode of UVP can reduce input current in short-circuit conditions.

Thermal Shutdown

Thermal shutdown is implemented to prevent the chip from operating at excessively high temperatures. When the junction temperature is higher than 150°C, the chip will shutdown the switching operation. The chip is automatically re-enabled when the junction temperature cools down by approximately 20°C.

Absolute Maximum Ratings (Note 1)

- Supply Input Voltage, V_{IN} ----- -0.3V to 20V
- Switch Voltage, SW ----- -0.3V to $V_{IN} + 0.3V$
 $<20ns$ ----- -5V
- BOOT to SW, $V_{BOOT} - SW$ ----- -0.3V to 6V (7V for $< 10\mu s$)
- Bias Supply Output, $PVCC$ ----- -0.3V to 6V (7V for $< 10\mu s$)
- Other Pins ----- -0.3V to 6V
- Power Dissipation, P_D @ $T_A = 25^\circ C$
 TSOT-23-8 (FC) ----- 1.428W
- Package Thermal Resistance (Note 2)
 TSOT-23-8 (FC), θ_{JA} ----- $70^\circ C/W$
 TSOT-23-8 (FC), θ_{JC} ----- $15^\circ C/W$
- Lead Temperature (Soldering, 10 sec.) ----- $260^\circ C$
- Junction Temperature ----- $-40^\circ C$ to $150^\circ C$
- Storage Temperature Range ----- $-65^\circ C$ to $150^\circ C$
- ESD Susceptibility (Note 3)
 HBM (Human Body Model) ----- 2kV

Recommended Operating Conditions (Note 4)

- Supply Input Voltage, V_{IN} ----- 4.5V to 17V
- Junction Temperature Range ----- $-40^\circ C$ to $125^\circ C$
- Ambient Temperature Range ----- $-40^\circ C$ to $85^\circ C$

Electrical Characteristics

($V_{IN} = 12V$, $T_A = 25^\circ C$, unless otherwise specified)

Parameter		Symbol	Test Conditions	Min	Typ	Max	Unit
Shutdown Supply Current			$V_{EN} = 0V$	--	--	1	μA
Quiescent Current with no Load at DCDC Output			$V_{EN} = 2V$, $V_{FB} = 1V$	--	0.8	1	mA
Feedback Voltage		V_{FB}		0.799	0.807	0.815	V
Feedback Current		I_{FB}	$V_{FB} = 820mV$	--	10	50	nA
Switch On-Resistance	High-Side	$R_{DS(ON)H}$		--	80	--	m Ω
	Low-Side	$R_{DS(ON)L}$		--	30	--	
Switch Leakage			$V_{EN} = 0V$, $V_{SW} = 0V$	--	--	1	μA
Current Limit		I_{LIM}	Under 40% duty-cycle	4.2	5	--	A
Low-Side Switch Current Limit			From Drain to Source	--	2	--	A
Oscillation Frequency		f_{OSC}	$V_{FB} = 0.75V$	1100	1400	1700	kHz
SYNC Frequency Range		f_{SYNC}		300	--	3000	kHz
Fold-Back Frequency			$V_{FB} < 400mV$	--	125	--	kHz
Maximum Duty-Cycle		D_{MAX}	$V_{FB} = 0.7V$	--	85	--	%

Parameter		Symbol	Test Conditions	Min	Typ	Max	Unit
Minimum On-Time		t _{ON}		--	60	--	ns
EN Input Voltage	Logic-High	V _{IH}		1.2	1.4	1.6	V
	Logic-Low	V _{IL}		1.1	1.25	1.4	
EN Input Current		I _{EN}	V _{EN} = 2V	--	2	--	μA
			V _{EN} = 0V	--	0	--	
EN Turn-off Delay		EN _{td-off}		--	8	--	μs
Input Under-Voltage Lockout Threshold	V _{IN} Rising	V _{UVLO}	V _{IN} Rising	3.7	3.9	4.1	V
	Hysteresis	ΔV _{UVLO}		--	650	--	mV
VCC Regulator		V _{CC}		--	5	--	V
VCC Load Regulation		ΔV _{LOAD}	I _{VCC} = 5mA	--	3	--	%
Soft-Start Charge Current		I _{SS}		--	11	--	μA
Thermal Shutdown Temperature		T _{SD}		--	150	--	°C
Thermal Shutdown Hysteresis		ΔT _{SD}		--	20	--	°C

Note 1. Stresses beyond those listed "Absolute Maximum Ratings" may cause permanent damage to the device. These are stress ratings only, and functional operation of the device at these or any other conditions beyond those indicated in the operational sections of the specifications is not implied. Exposure to absolute maximum rating conditions may affect device reliability.

Note 2. θ_{JA} is measured at T_A = 25°C on a high effective thermal conductivity four-layer test board per JEDEC 51-7. θ_{JC} is measured at the exposed pad of the package.

Note 3. Devices are ESD sensitive. Handling precaution recommended.

Note 4. The device is not guaranteed to function outside its operating conditions.

Typical Application Circuit

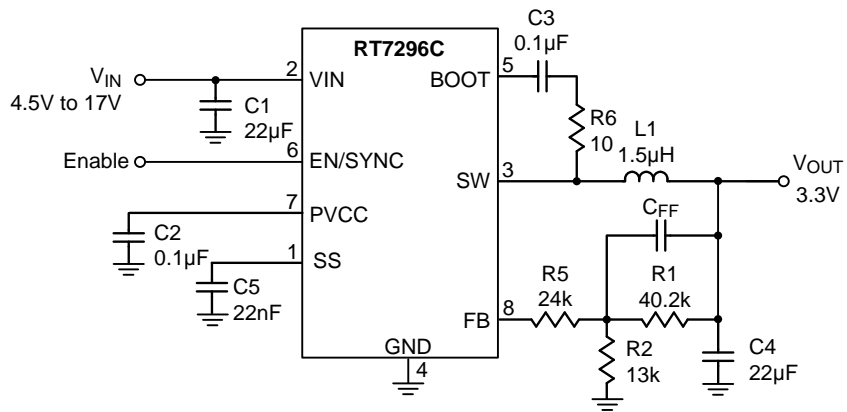

Note : All input and output capacitance in the suggested parameter mean the effective capacitance. The effective capacitance needs to consider any De-rating Effect like DC Bias.

Table 1. Suggested Component Values

V _{OUT} (V)	R1 (kΩ)	R2 (kΩ)	R5 (kΩ)	C _{ff} (pF)	C4 (µF)	L1 (µH)
1.0	20.5	84.5	140	15	22	0.52
3.3	40.2	13	24	15	22	1.5
5.0	40.2	7.68	24	15	22	1.5

Typical Operating Characteristics

Efficiency vs. Output Current

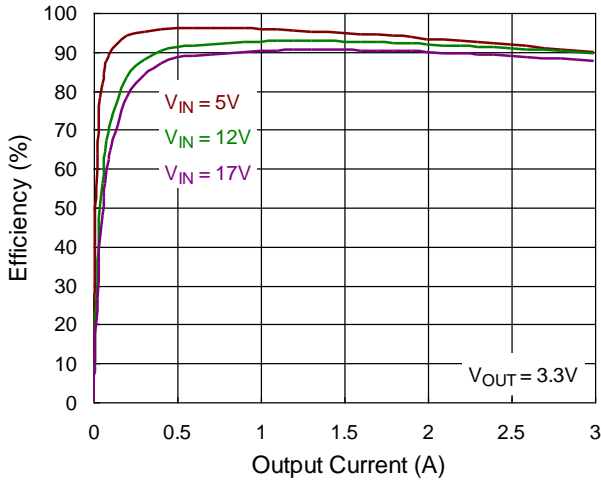

Output Voltage vs. Input Voltage

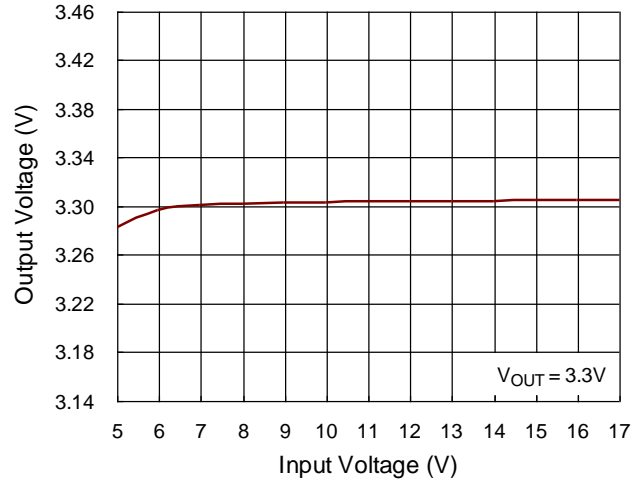

Reference Voltage vs. Temperature

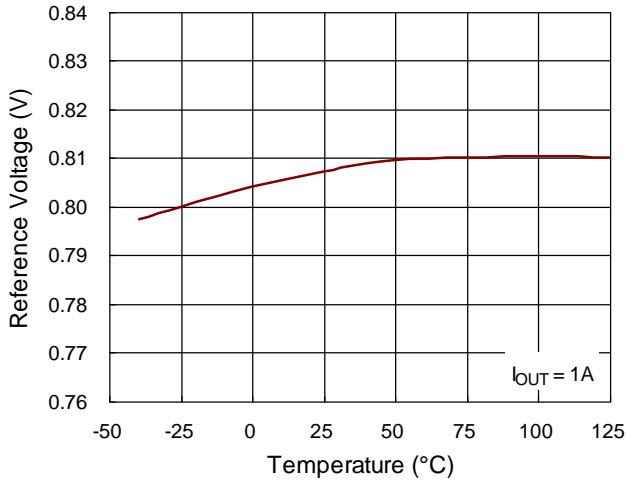

Output Voltage vs. Output Current

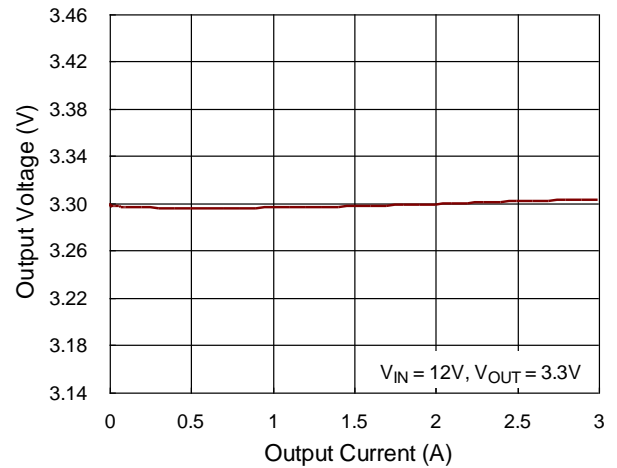

UVLO Voltage vs. Temperature

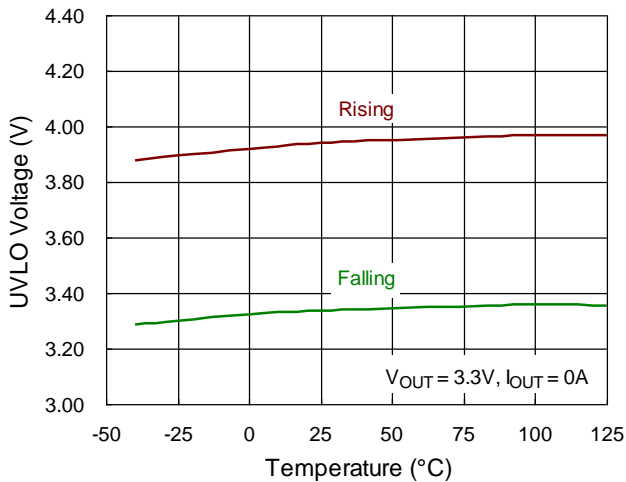

EN Threshold vs. Temperature

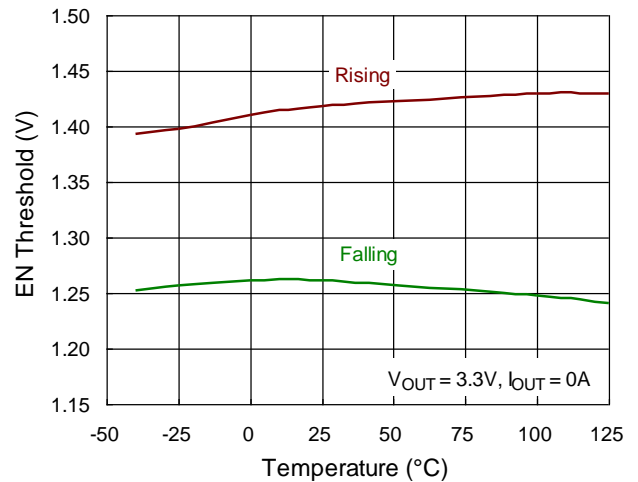

Load Transient Response

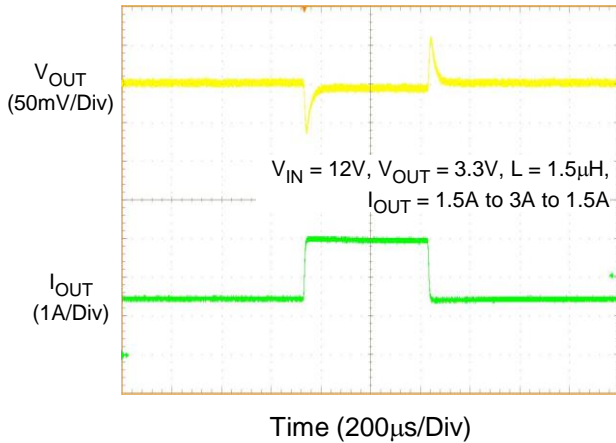

Output Ripple Voltage

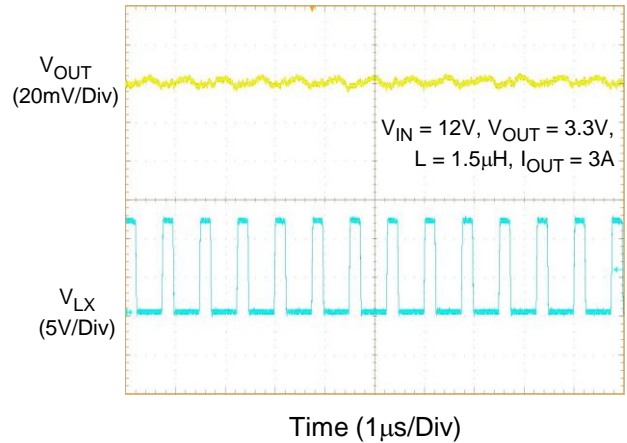

Power On from EN

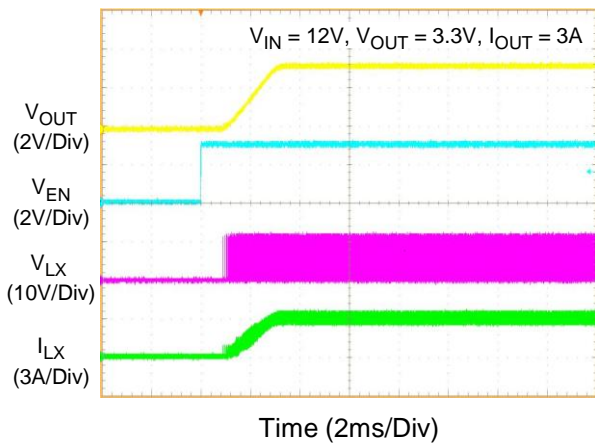

Power Off from EN

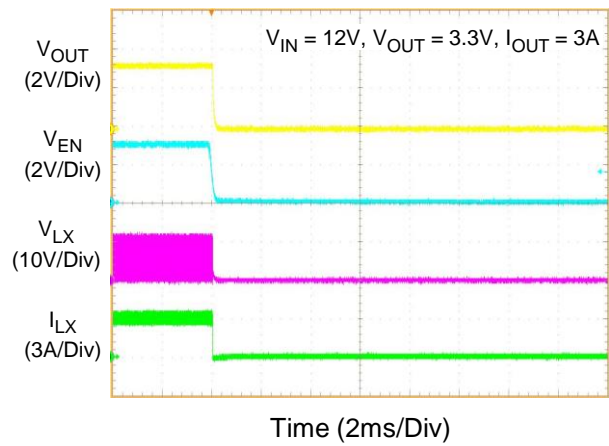

Power On from VIN

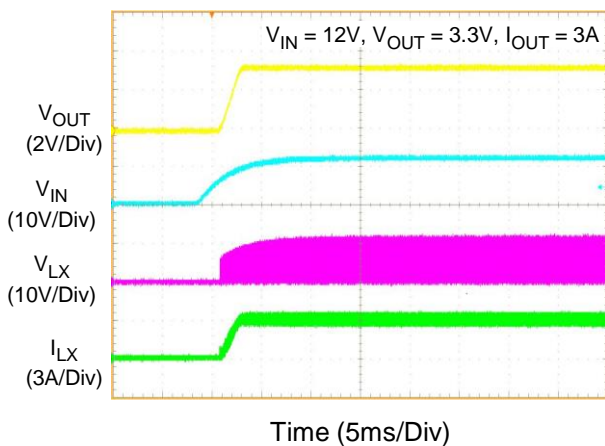

Power Off from VIN

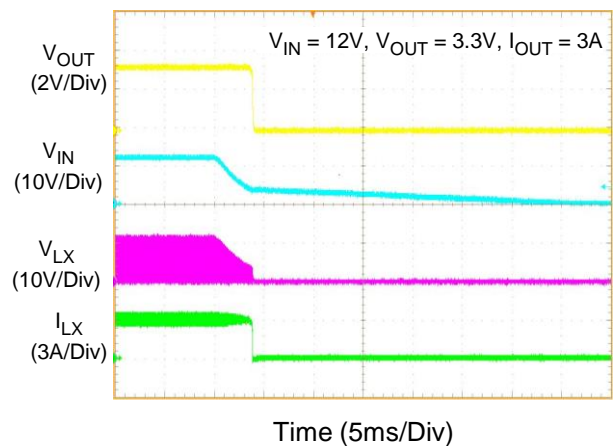

Application Information

The RT7296C is a high voltage buck converter that can support the input voltage range from 4.5V to 17V and the input voltage range from 4.5V to 17V and the output current can be up to 3A.

Output Voltage Selection

The resistive voltage divider allows the FB pin to sense a fraction of the output voltage as shown in Figure 1.

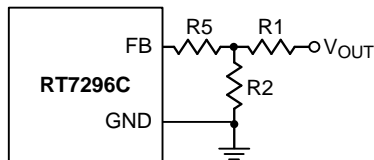

Figure 1. Output Voltage Setting

For adjustable voltage mode, the output voltage is set by an external resistive voltage divider according to the following equation :

$$V_{OUT} = V_{FB} \left(1 + \frac{R1}{R2} \right)$$

Where V_{FB} is the feedback reference voltage (0.807V typ.). Table 2 lists the recommended resistors value for common output voltages.

Table 2. Recommended Resistors Value

V _{OUT} (V)	R1 (kΩ)	R2 (kΩ)	R5 (kΩ)
1.0	20.5	84.5	140
3.3	40.2	13	24
5.0	40.2	7.68	24

External Bootstrap Diode

Connect a 100nF low ESR ceramic capacitor between the BOOT pin and SW pin. This capacitor provides the gate driver voltage for the high side MOSFET. It is recommended to add an external bootstrap diode between an external 5V and BOOT pin, as shown as Figure 2, for efficiency improvement when input voltage is lower than 5.5V or duty ratio is higher than 65%. The bootstrap diode can be a low cost one such as IN4148 or BAT54. The external 5V can be a 5V fixed input from system or a 5V output (PVCC) of the RT7296C.

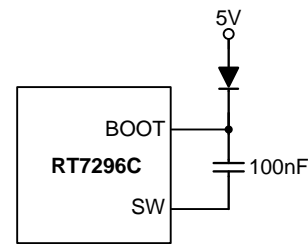

Figure 2. External Bootstrap Diode

External Soft-Start Capacitor

RT7296C provides external soft-start function. The soft-start function is used to prevent large inrush current while converter is being powered-up. The soft-start timing can be programmed by the external capacitor (C_{SS}) between SS pin and GND. The Chip provides a 11μA charge current (I_{SS}) for the external capacitor. The soft-start time (t_{SS} , V_{REF} is from 0V to 0.8V) can be calculated by the following formula :

$$t_{SS}(ms) = \frac{C_{SS}(nF) \times 1.3}{I_{SS}(\mu A)}$$

Inductor Selection

The inductor value and operating frequency determine the ripple current according to a specific input and output voltage. The ripple current ΔI_L increases with higher V_{IN} and decreases with higher inductance.

$$\Delta I_L = \left(\frac{V_{OUT}}{f \times L} \right) \times \left(1 - \frac{V_{OUT}}{V_{IN}} \right)$$

Having a lower ripple current reduces not only the ESR losses in the output capacitors but also the output voltage ripple. High frequency with small ripple current can achieve highest efficiency operation. However, it requires a large inductor to achieve this goal.

For the ripple current selection, the value of $\Delta I_L = 0.3(I_{MAX})$ will be a reasonable starting point. The largest ripple current occurs at the highest V_{IN} . To guarantee that the ripple current stays below the specified maximum, the inductor value should be chosen according to the following equation :

$$L = \left(\frac{V_{OUT}}{f \times \Delta I_L(MAX)} \right) \times \left(1 - \frac{V_{OUT}}{V_{IN(MAX)}} \right)$$

The inductor's current rating (caused a 40°C temperature rising from 25°C ambient) should be greater than the maximum load current and its saturation current should be greater than the short circuit peak current limit.

C_{IN} and C_{OUT} Selection

The input capacitance, C_{IN}, is needed to filter the trapezoidal current at the source of the top MOSFET. To prevent large ripple current, a low ESR input capacitor sized for the maximum RMS current should be used. The RMS current is given by :

$$I_{RMS} = I_{OUT(MAX)} \frac{V_{OUT}}{V_{IN}} \sqrt{\frac{V_{IN}}{V_{OUT}} - 1}$$

This formula has a maximum at V_{IN} = 2V_{OUT}, where I_{RMS} = I_{OUT}/2. This simple worst-case condition is commonly used for design because even significant deviations do not offer much relief.

Choose a capacitor rated at a higher temperature than required. Several capacitors may also be paralleled to meet size or height requirements in the design. The selection of C_{OUT} is determined by the required Effective Series Resistance (ESR) to minimize voltage ripple. Moreover, the amount of bulk capacitance is also a key for C_{OUT} selection to ensure that the control loop is stable. Loop stability can be checked by viewing the load transient response as described in a later section. The output ripple, ΔV_{OUT}, is determined by :

$$\Delta V_{OUT} \leq \Delta I_L \times \left(ESR + \frac{1}{8fC_{OUT}} \right)$$

The output ripple will be highest at the maximum input voltage since ΔI_L increases with input voltage. Multiple capacitors placed in parallel may be needed to meet the ESR and RMS current handling requirement. Dry tantalum, special polymer, aluminum electrolytic and ceramic capacitors are all available in surface mount packages. Special polymer capacitors offer very low ESR value. However, it provides lower capacitance density than other types. Although Tantalum capacitors have the highest capacitance density, it is important to only use types that pass the surge test for use in switching power supplies. Aluminum electrolytic capacitors have significantly higher ESR. However, it can be used in cost-sensitive applications for ripple

current rating and long term reliability considerations. Ceramic capacitors have excellent low ESR characteristics but can have a high voltage coefficient and audible piezoelectric effects. The high Q of ceramic capacitors with trace inductance can also lead to significant ringing.

Thermal Considerations

For continuous operation, do not exceed absolute maximum junction temperature. The maximum power dissipation depends on the thermal resistance of the IC package, PCB layout, rate of surrounding airflow, and difference between junction and ambient temperature. The maximum power dissipation can be calculated by the following formula :

$$P_{D(MAX)} = (T_{J(MAX)} - T_A) / \theta_{JA}$$

where T_{J(MAX)} is the maximum junction temperature, T_A is the ambient temperature, and θ_{JA} is the junction to ambient thermal resistance.

For recommended operating condition specifications, the maximum junction temperature is 125°C. The junction to ambient thermal resistance, θ_{JA}, is layout dependent. For TSOT-23-8 (FC) package, the thermal resistance, θ_{JA}, is 70°C/W on a standard JEDEC 51-7 four-layer thermal test board. The maximum power dissipation at T_A = 25°C can be calculated by the following formula :

$$P_{D(MAX)} = (125^\circ\text{C} - 25^\circ\text{C}) / (70^\circ\text{C/W}) = 1.428\text{W for TSOT-23-8 (FC) package}$$

The maximum power dissipation depends on the operating ambient temperature for fixed T_{J(MAX)} and thermal resistance, θ_{JA}. The derating curve in Figure 3 allows the designer to see the effect of rising ambient temperature on the maximum power dissipation.

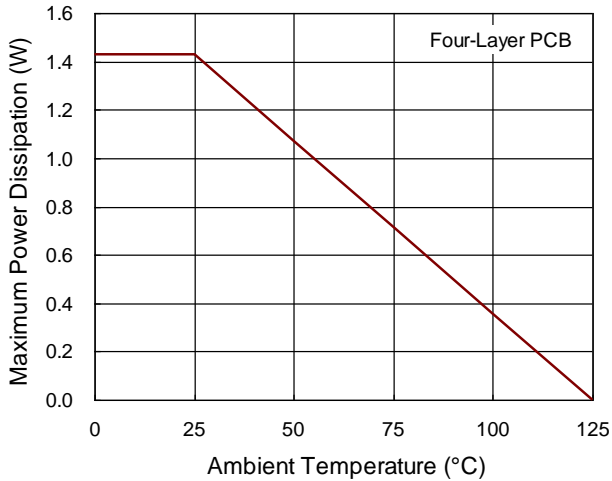

Figure 3. Derating Curve of Maximum Power Dissipation

Layout Considerations

For best performance of the RT7296C, the following layout guidelines must be strictly followed.

- Input capacitor must be placed as close to the IC as possible.
- SW should be connected to inductor by wide and short trace. Keep sensitive components away from this trace.
- Keep every trace connected to pin as wide as possible for improving thermal dissipation.

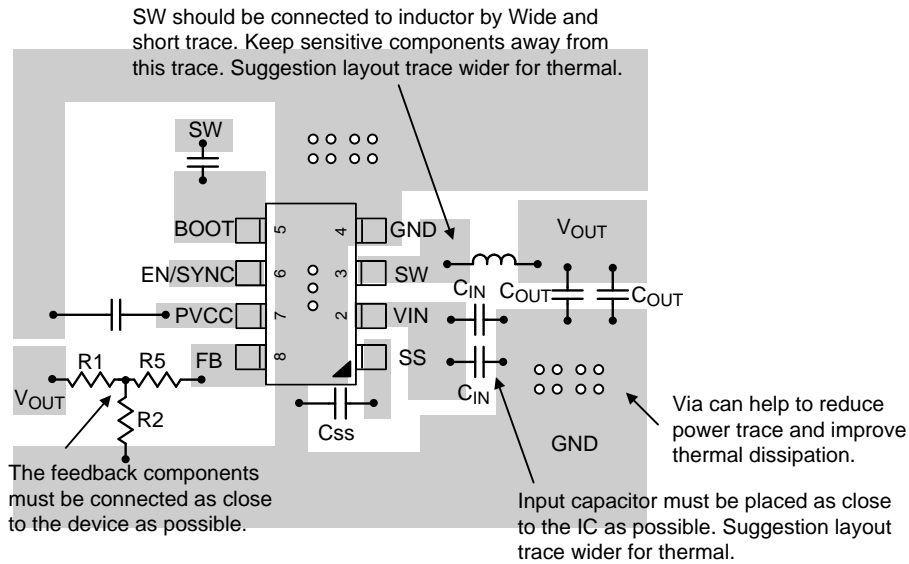
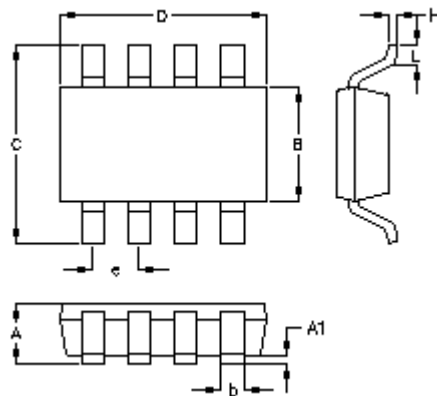

Figure 4. PCB Layout Guide

Outline Dimension



Symbol	Dimensions In Millimeters		Dimensions In Inches	
	Min.	Max.	Min.	Max.
A	0.700	1.000	0.028	0.039
A1	0.000	0.100	0.000	0.004
B	1.397	1.803	0.055	0.071
b	0.220	0.380	0.009	0.015
C	2.591	3.000	0.102	0.118
D	2.692	3.099	0.106	0.122
e	0.585	0.715	0.023	0.028
H	0.080	0.254	0.003	0.010
L	0.300	0.610	0.012	0.024

TSOT-23-8 (FC) Surface Mount Package

Richtek Technology Corporation

14F, No. 8, Tai Yuen 1st Street, Chupei City
 Hsinchu, Taiwan, R.O.C.
 Tel: (8863)5526789

Richtek products are sold by description only. Richtek reserves the right to change the circuitry and/or specifications without notice at any time. Customers should obtain the latest relevant information and data sheets before placing orders and should verify that such information is current and complete. Richtek cannot assume responsibility for use of any circuitry other than circuitry entirely embodied in a Richtek product. Information furnished by Richtek is believed to be accurate and reliable. However, no responsibility is assumed by Richtek or its subsidiaries for its use; nor for any infringements of patents or other rights of third parties which may result from its use. No license is granted by implication or otherwise under any patent or patent rights of Richtek or its subsidiaries.

Copyright © 2016 Richtek Technology Corporation. All rights reserved. **RICHTEK** is a registered trademark of Richtek Technology Corporation.