

LOC	DIST	REVISIONS					
		P	LTH	DESCRIPTION	DATE	DMN	APVD
ES	00	P9		ADDED NEW DASH NUMBER -69	29JAN2013	ML	SZ

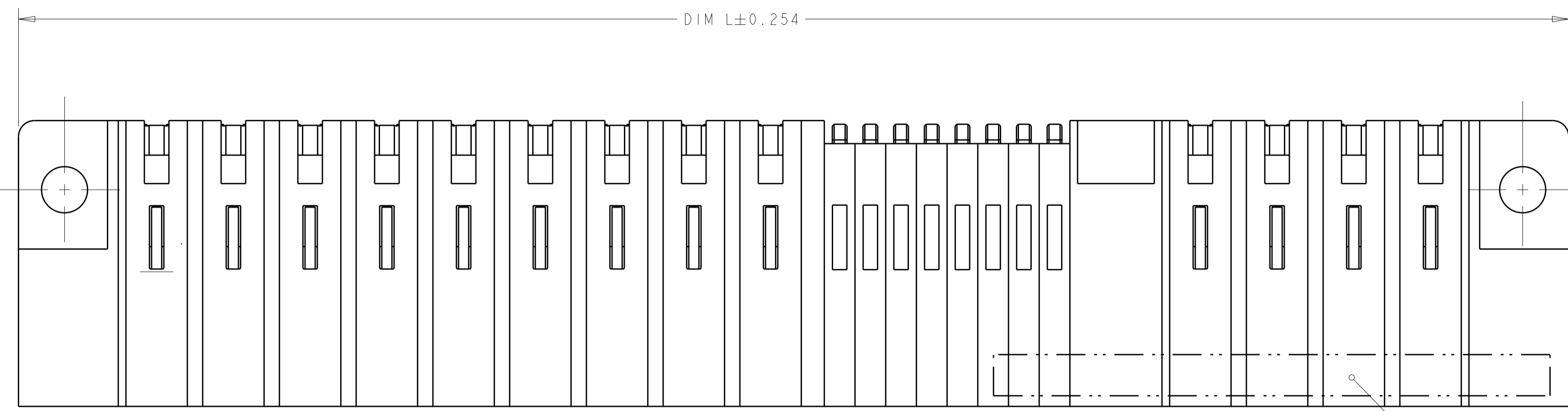

- 1 OPTIONAL CENTER MODULE WITH Ø.150 THRU HOLE OR HOLD DOWN FEATURE.
- 2 "AMP", PART NUMBER, AND DATECODE TO BE MARKED IN AREA SHOWN. PARTS UNDER 2.00 LONG MAY BE MARKED ON BOTH SIDES.
- 3 MATERIAL:
HOUSING - GLASS FILLED HIGH TEMP THERMO PLASTIC, UL94 V-0
SIGNAL CONTACT - COPPER ALLOY
POWER CONTACT - HIGH CONDUCTIVITY COPPER ALLOY
- 4 CONTACT PLATING: NOBLE METAL PLATING ON CONTACT FUNCTIONAL AREA OF POWER AND SIGNAL CONTACTS
- 5 MECHANICAL CONNECTOR KEEP OUT ZONE.
- 6 DATUM AND BASIC DIMENSIONS ESTABLISHED BY CUSTOMER.
- 7 PCB - HOLE DIAMETERS ARE FINISHED HOLE SIZE.
- 8 PCB - .0453 ± .0010 DRILLED HOLES PLATED WITH .0003 MIN Sn OVER .001 TO .003 Cu PLATING TO ACHIEVE A .040 DIA HOLE.
- 10 VARIABLE DIMENSIONS SHOWN ON VIEW (SHEET 5,11)

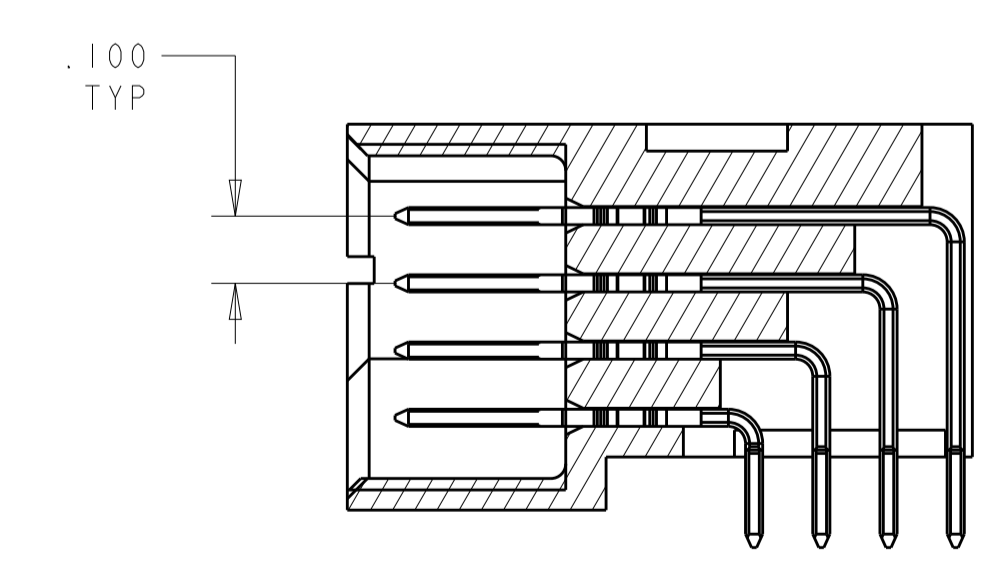
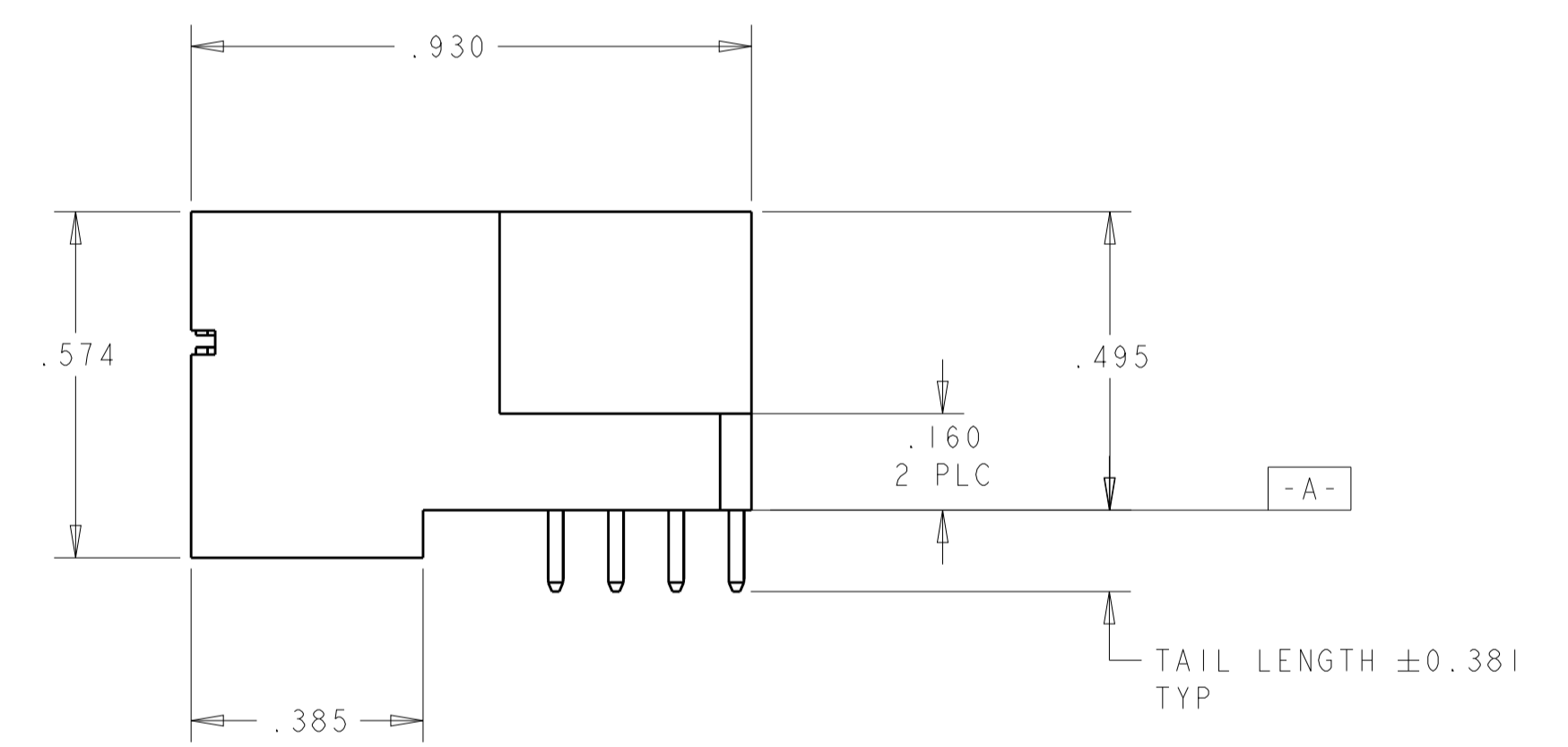
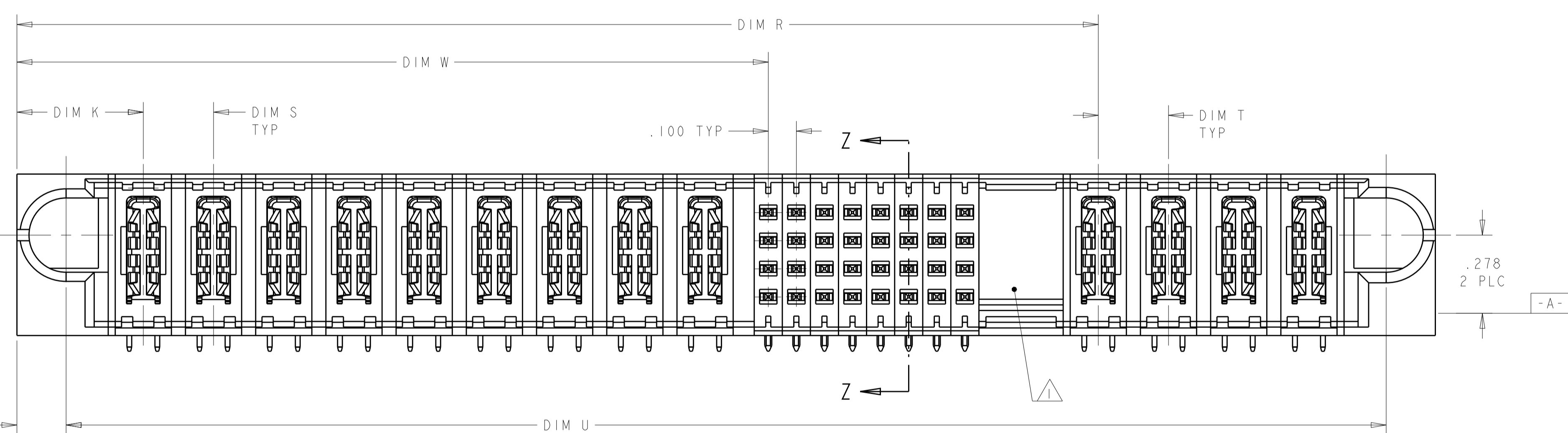

SECTION Z-Z

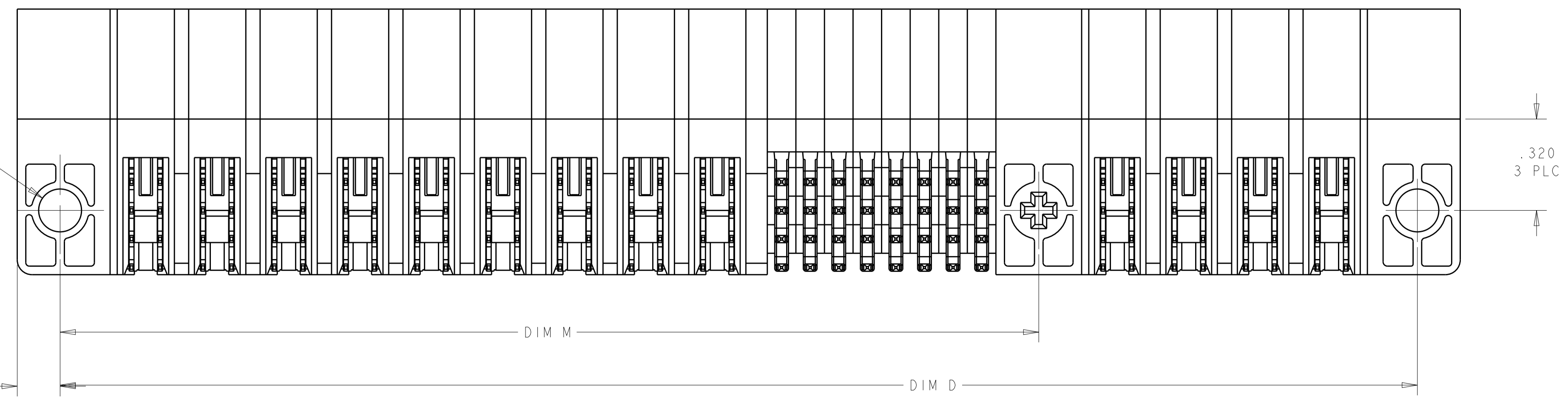

THIS DRAWING IS A CONTROLLED DOCUMENT.

DIMENSIONS: INCHES	TOLERANCES UNLESS OTHERWISE SPECIFIED: 0 PLC ±. 1 PLC ±.01 2 PLC ±.01 3 PLC ±.005 4 PLC ±.0020 ANGLES ±.0°	DMN: R. GRZYBOWSKI 28FEB05 CHK: M. PERCHERKE 28FEB05 APVD: M. PERCHERKE PRODUCT SPEC: 108-1973 APPLICATION SPEC: 114-13038 WEIGHT: -	TE Connectivity RIGHT ANGLE HEADER ASSEMBLY SOLDER TAILS, W/GUIDES MULTI-BEAM XL
MATERIAL: 3	FINISH: 4	SIZE: A1 CAGE CODE: 6450330 DRAWING NO: 100779	RESTRICTED TO: - SCALE: 4:1 SHEET: 1 OF 19 REV: P9

CUSTOMER DRAWING

LOC	DIST	REVISIONS			
ES	00	REV	DATE	BY	APPV
-	-	SEE SHEET 1	-	-	-

U	S	T	R	W	D	M	L	K	DESCRIPTION	PART NUMBER
1.575	-	-	1.425	.700	1.625	-	1.925	.475	IP + 24S + 1P	6-6450330-7
1.575	-	-	1.425	.700	1.625	-	1.925	.475	IP + 24S + 1P	6-6450330-6
1.800	-	-	1.700	.625	1.850	-	2.150	.450	IP + 40S + 1P	6-6450330-5
1.550	.250	.250	1.200	.900	1.600	-	1.900	.450	2P + 8S + 2P	6-6450330-4
1.300	-	-	1.200	.675	1.350	-	1.650	.450	IP + 16S + 1P	6-6450330-3
2.300	.250	.250	1.700	1.175	2.350	-	2.650	.450	3P + 16S + 3P	6-6450330-1
7.350	△	△	5.225	3.925	7.400	-	7.700	.475	12P + 48S + 8P	6-6450330-0
2.600	.250	.250	2.250	1.925	2.650	-	2.950	.450	6P + 8S + 2P	5-6450330-9
4.500	.300	.300	2.875	2.175	4.550	-	4.850	.475	6ACP + 24S + 6ACP	5-6450330-8
2.400	.200	.200	2.100	.825	2.450	-	2.750	.450	2P + 48S + 2P	5-6450330-7
1.700	.250	.250	1.350	.875	1.750	-	2.050	.450	2P + 16S + 2P	5-6450330-6
1.200	-	-	1.100	.625	1.250	-	1.550	.450	IP + 16S + 1P	5-6450330-5
3.550	.200	△	2.225	1.925	3.600	-	3.900	.500	7P + 8S + 7P	5-6450330-4
2.900	.250	.250	2.050	1.375	2.950	-	3.250	.450	4P + 24S + 4P	5-6450330-3
2.400	.250	.250	1.800	1.125	2.450	-	2.750	.450	3P + 24S + 3P	5-6450330-2
1.700	.250	.250	1.350	.875	1.750	-	2.050	.450	2P + 16S + 2P	5-6450330-1
2.800	.250	.300	2.075	1.375	2.850	-	3.150	.450	4P + 24S + 3ACP	5-6450330-0
1.700	.250	.250	1.350	.875	1.750	-	2.050	.450	2P + 16S + 2P	4-6450330-9
1.575	.250	.250	1.425	.700	1.625	-	1.925	.475	IP + 24S + 1P	4-6450330-7
1.600	.250	.250	1.250	.925	1.650	-	1.950	.450	2P + 8S + 2P	4-6450330-6
2.400	.250	.250	2.050	1.375	2.450	-	2.750	.450	4P + 24S + 2P	4-6450330-2
2.400	.250	.250	1.800	1.125	2.450	-	2.750	.450	3P + 24S + 3P	3-6450330-9
3.000	.250	.250	2.150	1.425	3.050	-	3.350	.450	4P + 24S + 4P	3-6450330-7
2.400	.250	.250	1.550	.875	2.450	-	2.750	.450	2P + 24S + 4P	3-6450330-5
.700	-	-	-	.375	.750	-	1.050	-	0P + 16S + 0P	3-6450330-1
2.800	.300	.250	1.950	1.275	2.850	-	3.150	.475	3ACP + 24S + 4P	2-6450330-8
2.800	.300	.300	2.075	1.325	2.850	-	3.150	.475	3ACP + 24S + 3ACP	2-6450330-6
3.300	.250	.250	2.450	1.375	3.350	-	3.650	.450	4P + 40S + 4P	2-6450330-3
2.700	.200	.200	2.000	1.225	2.750	-	3.050	.450	4P + 28S + 4P	1-6450330-8
2.000	.250	.250	1.650	.925	2.050	-	2.350	.450	2P + 24S + 2P	1-6450330-4
3.150	.250	.250	2.300	1.625	3.200	-	3.500	.450	5P + 24S + 4P	1-6450330-3
.900	-	-	-	.375	.950	-	1.250	-	0P + 24S + 0P	1-6450330-2
1.575	.250	.250	1.425	.700	1.625	-	1.925	.475	IP + 24S + 1P	1-6450330-1
4.000	△	△	2.750	2.075	4.050	-	4.350	.450	2ACP + 5P + 24S + 6P	1-6450330-0
2.800	.250	.250	1.950	1.375	2.850	-	3.150	.450	4P + 20S + 4P	6450330-9
1.575	.250	.250	1.425	.700	1.625	-	1.925	.475	IP + 24S + 1P	6450330-8
3.300	.300	.250	1.950	1.275	3.350	-	3.650	.475	3ACP + 24S + 6P	6450330-7
1.900	NA	NA	.975	.625	1.950	-	2.250	.450	IP + 12S + 5P	6450330-6
4.000	NA	NA	2.750	2.075	4.050	-	4.350	.450	3ACP + 4P + 24S + 6P	6450330-5
2.550	.300	.250	2.150	1.525	2.600	-	2.900	.475	3ACP + 1P + 24S + 2P	6450330-4
4.350	.250	.250	3.500	2.625	4.400	-	4.700	.450	9P + 32S + 4P	6450330-3
1.575	.250	.250	1.425	.700	1.625	-	1.925	.475	IP + 24S + 1P	6450330-1

1.200	-	-	1.100	.625	1.250	-	1.550	.450	IP + 16S + 1P	6-6450330-9
4.125	.300	.250	2.775	1.900	4.175	-	4.475	.475	5ACP + 32S + 6P	6-6450330-8
U	S	T	R	W	D	M	L	K	DESCRIPTION	PART NUMBER

THIS DRAWING IS A CONTROLLED DOCUMENT. OWN: R. GRZYBOWSKI, 28FEB05
 CHK: M. PERCZERKE, 28FEB05
 APV: M. PERCZERKE

TE Connectivity
STE
 RIGHT ANGLE HEADER ASSEMBLY
 SOLDER TAILS, W/GUIDES
 MULTI-BEAM XL

PRODUCT SPEC: 108-1973
 APPLICATION SPEC: 114-13038
 SIZE: A100779, CAGE CODE: 6450330
 WEIGHT: -
 CUSTOMER DRAWING

SCALE: 1:1 SHEET 2 OF 19 REV: P9

PART NUMBER	ROWS	SIGNAL						POWER	
		P1	1	2	3	4	5	6	P2
6450330-1	D C B A	J	J	J	J	J	J	PM	PM
		K	K	K	K	K	K		
		N	N	N	G	N	N		
		S	S	S	S	S	S		

IP + 24S + IP

PART NUMBER	ROWS	SIGNAL						POWER	
		P1	1	2	3	4	5	6	P2
4-6450330-7	D C B A	E	E	E	E	E	J	PM	PM
		F	F	F	F	F	K		
		N	N	N	N	N	N		
		S	S	S	S	S	S		

IP + 24S + IP

PART NUMBER	ROWS	POWER				SIGNAL						POWER	
		P1	P2	P3	P4	1	2	3	4	5	6	P5	P6
6450330-4	D C B A	PM	PM	PM	PM	E	J	J	J	J	E	PM	PM
						K	K	F	K	K	K		
						N	N	N	N	N	N		
						H	S	S	S	S	H		

3ACP + IP + 24S + 2P

.275 REF.

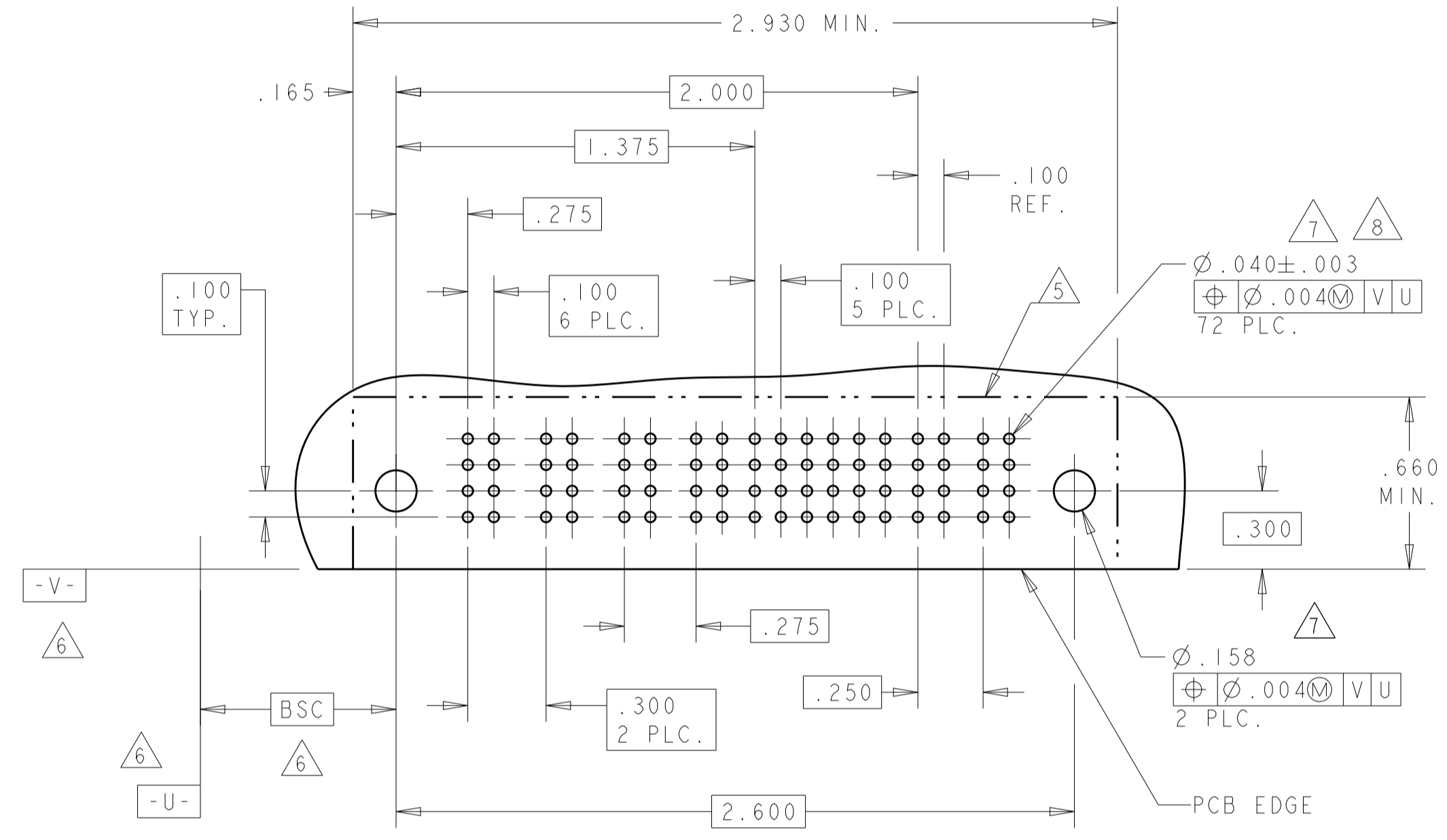
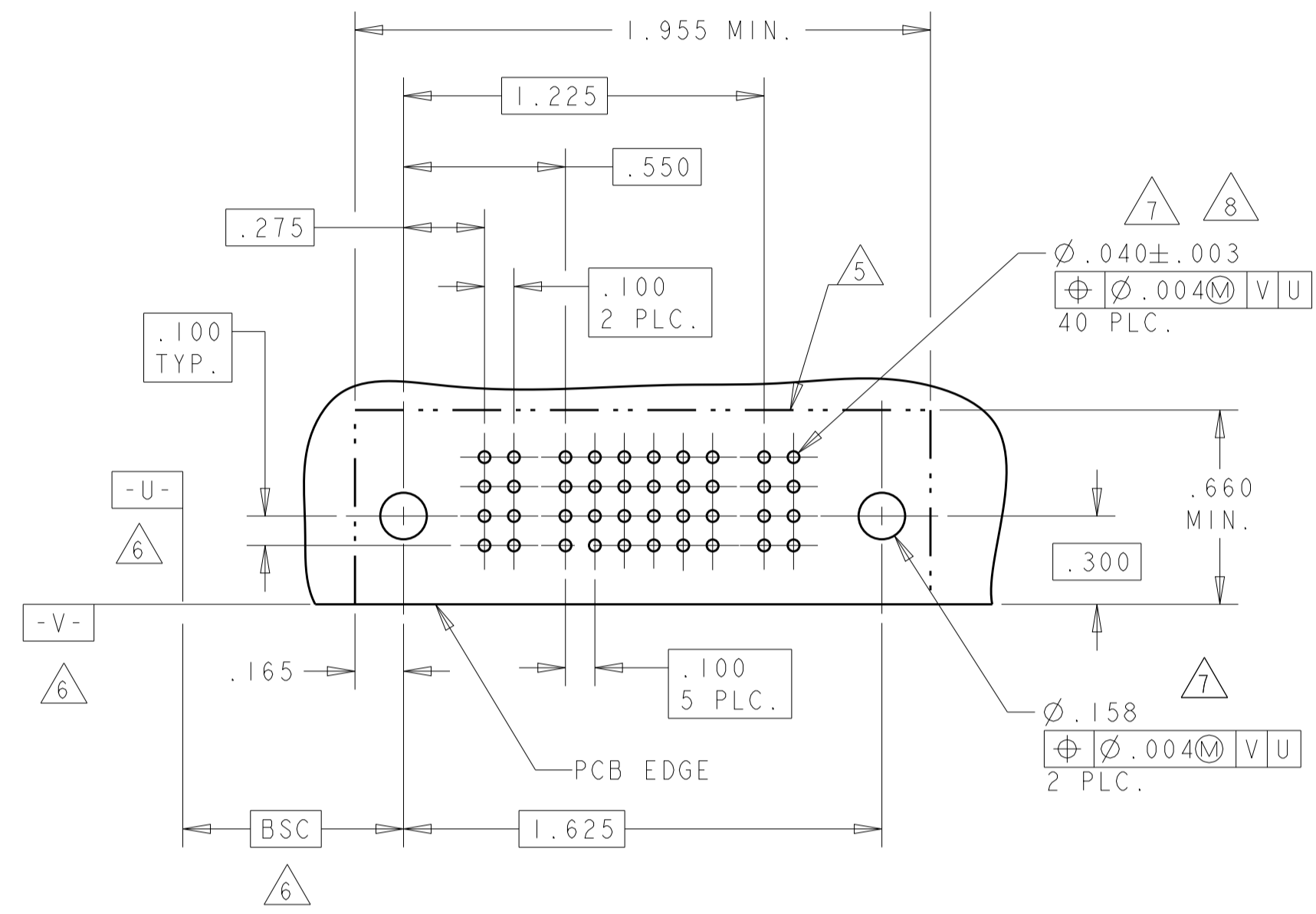

6450330-1 AND 4-6450330-7 SHARE THE SAME LAYOUT

NO CONTACT LOADED

PART NUMBER	ROWS	POWER									SIGNAL								POWER			
		P1	P2	P3	P4	P5	P6	P7	P8	P9	1	2	3	4	5	6	7	8	P10	P11	P12	P13
6450330-3	D C B A	PM	PM	PM	PM	PM	PM	PM	PM	PM	J	J	J	J	J	E	E	E	PM	PM	PM	PM
											K	K	K	K	K	K	K	K				
											N	N	N	N	N	N	N	N				
											S	S	S	S	S	S	S	S				

9P + 32S + 4P

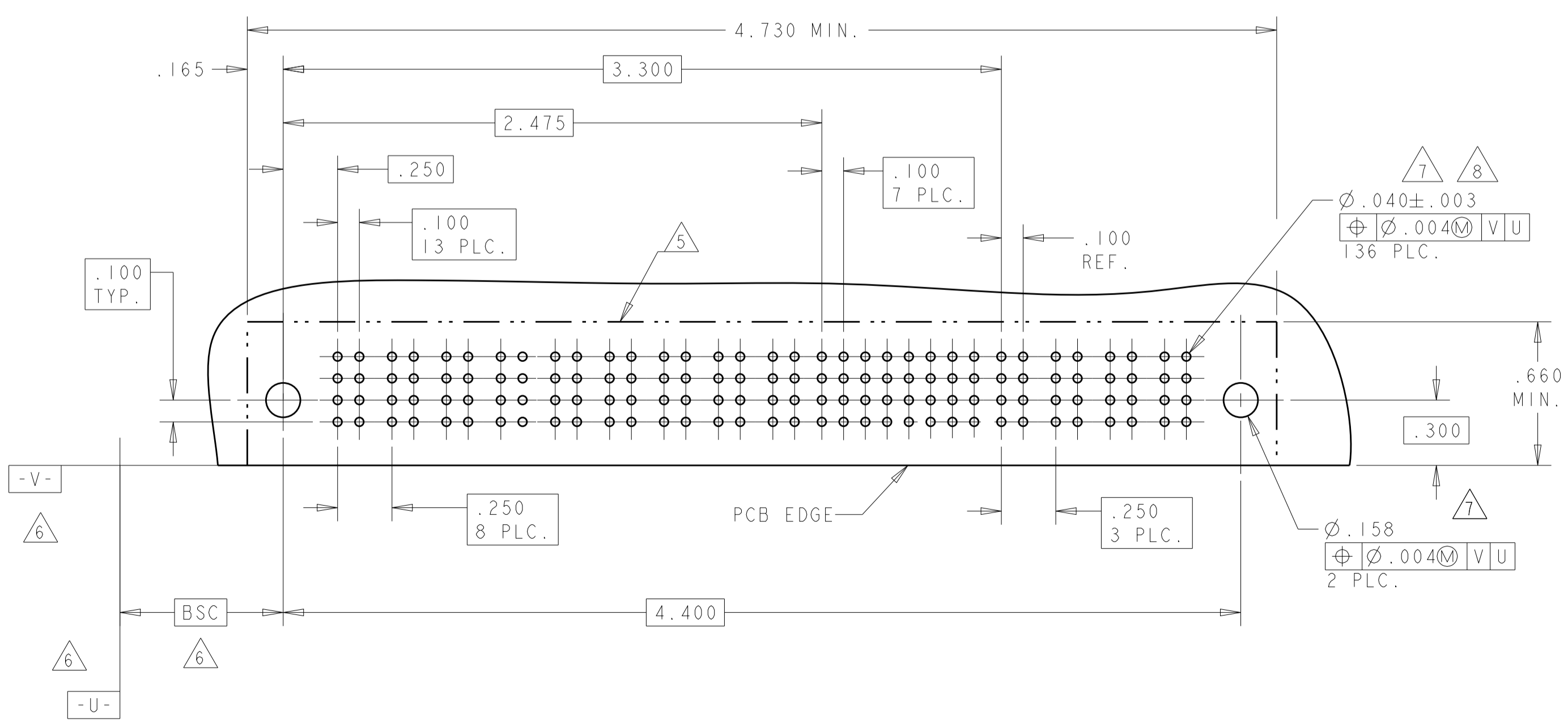

CODE	MATING SEQUENCE	TAIL LENGTH	ROW
FS	MFBL	.135	A
Z	STD	.090	D
Y	STD	.090	C
R	STD	.090	B
O	STD	.090	A
A4	MLBF	.090	D
A3	MLBF	.090	C
A2	MLBF	.090	B
A1	MLBF	.090	A
FS	MFBL	.135	A
E	MLBF	.135	D
F	MLBF	.135	C
G	MLBF	.135	B
H	MLBF	.135	A
J	STD	.135	D
K	STD	.135	C
N	STD	.135	B
S	STD	.135	A

CODE	TAIL LENGTH
PA	.090
PM	.135

POWER CONTACT

THIS DRAWING IS A CONTROLLED DOCUMENT.

OWN: R. GRZYBOWSKI 28FEB05
CHK: M. PERCHERKE 28FEB05
APVD: M. PERCHERKE

STE TE Connectivity

RIGHT ANGLE HEADER ASSEMBLY
SOLDER TAILS, W/GUIDES
MULTI-BEAM XL

SIZE: CAGE CODE: DRAWING NO: 114-13038
REVISION: 108-1973
WEIGHT: 114-13038
SCALE: 1:1 SHEET 3 OF 19 REV P.9

LOC	DIST	REVISIONS			
ES	00	REV	DATE	BY	APPV
		1	SEE SHEET 1		

PART NUMBER	ROWS	POWER						SIGNAL						POWER							
		P1	P2	P3	P4	P5	P6	P7	1	2	3	4	5	6	P8	P9	P10	P11	P12	P13	
6450330-5	D	PM	PM	PM	PM	PM	PM	J	J	J	J	J	J	PM	PM	PM	PM	PM	PM		
	C							K	K	K	K	K	K								
	B							N	N	N	N	N	N								
	A							S	S	S	S	S	H								
3ACP + 4P + 24S + 6P																					

PART NUMBER	ROWS	POWER			SIGNAL			POWER				
		P1	1	2	3	P2	P3	P4	P5	P6		
6450330-6	D	PM	J	J	J	PM	PM	PM	PM	PM		
	C		K	K	K							
	B		N	N	N							
	A		S	S	S							
1P + 12S + 5P												

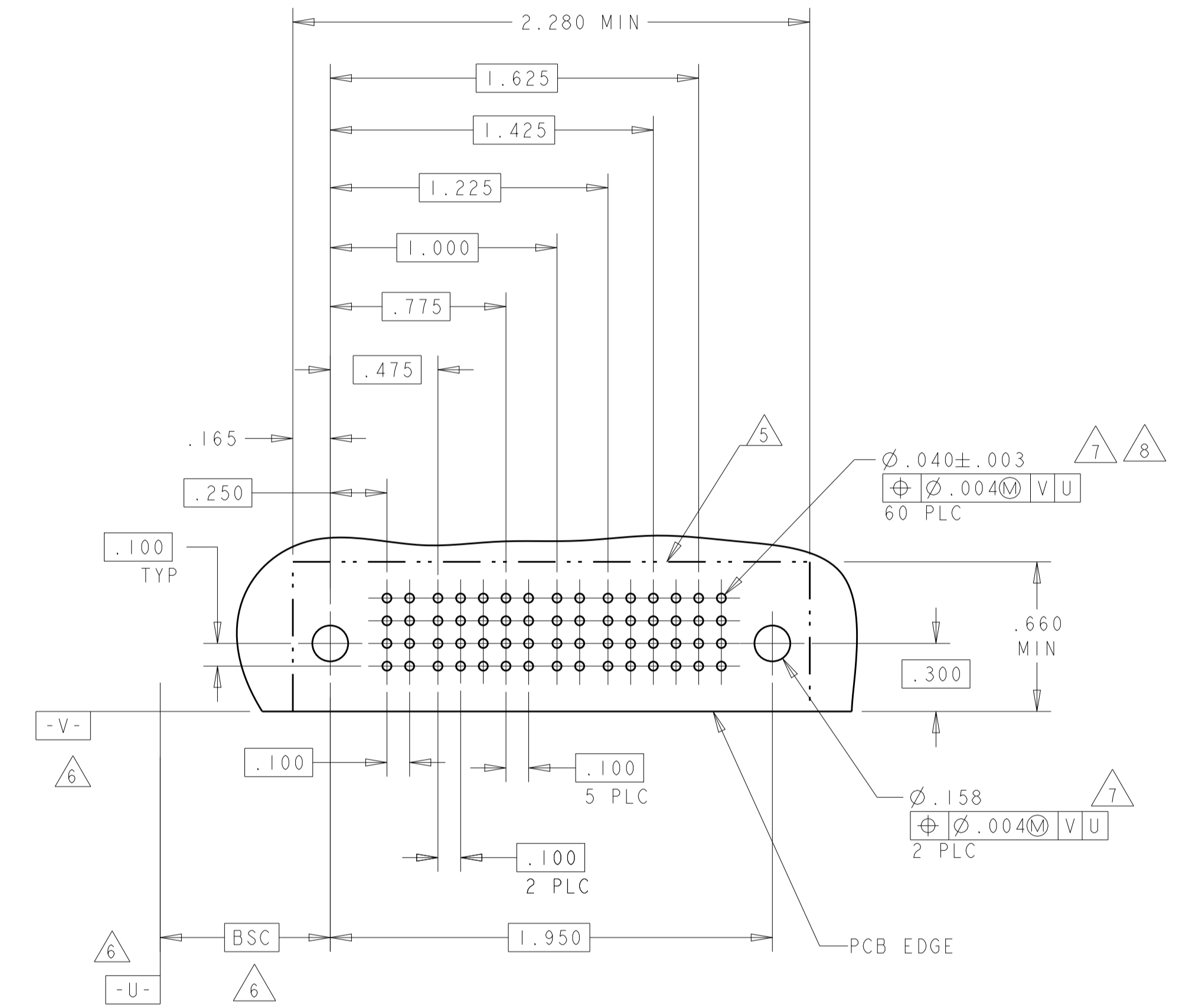
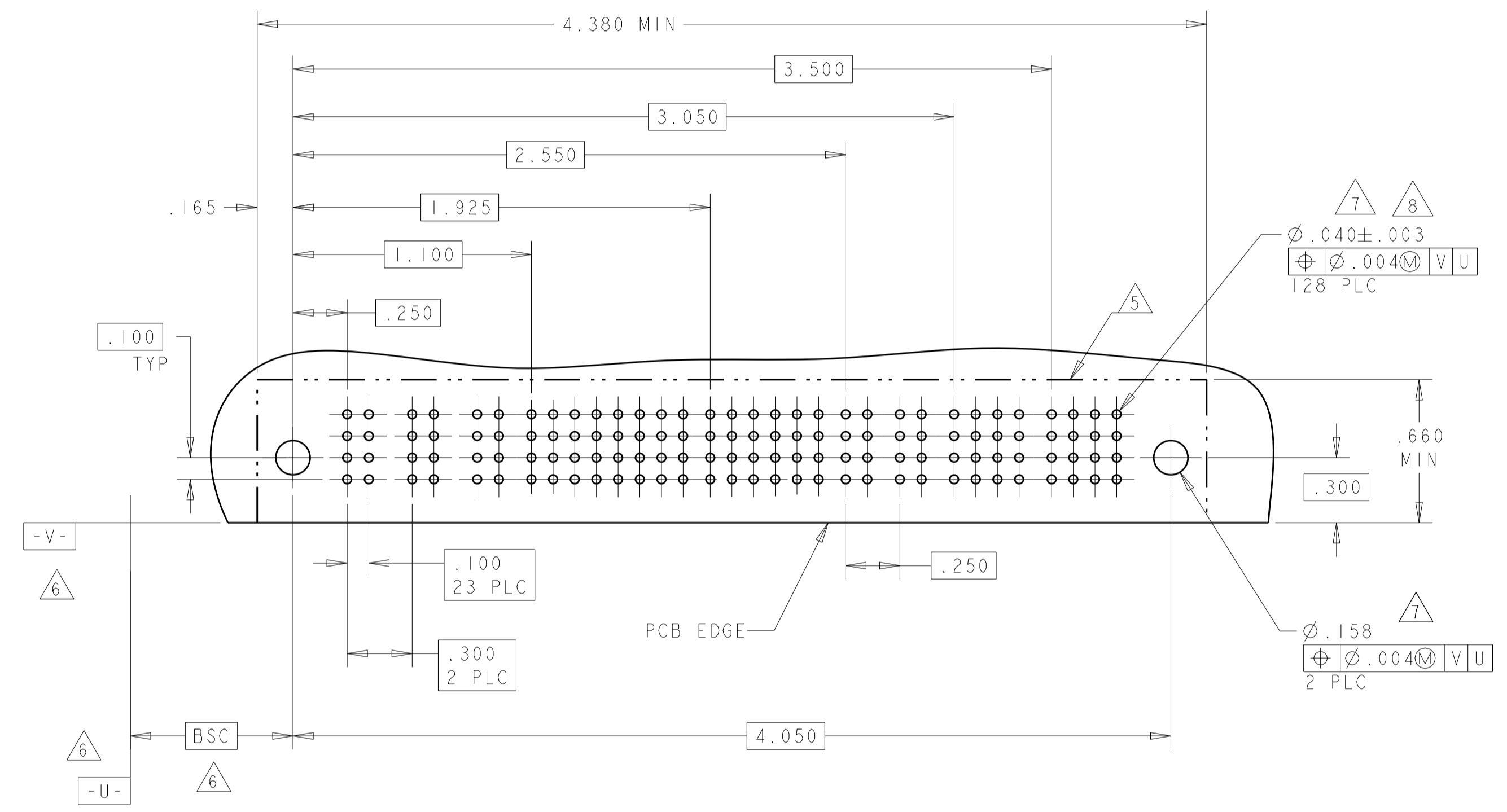
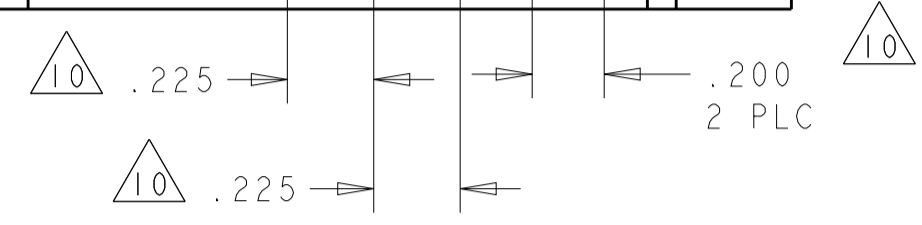

THIS DRAWING IS A CONTROLLED DOCUMENT.		OWN: R. GRZYBOWSKI 28FEB05	TE Connectivity RIGHT ANGLE HEADER ASSEMBLY SOLDER TAILS, W/GUIDES MULTI-BEAM XL
DIMENSIONS: INCHES		CHK: M. PERCHERKE 28FEB05	
TOLERANCES UNLESS OTHERWISE SPECIFIED: 0 PLC ±. 1 PLC ±.01 2 PLC ±.01 3 PLC ±.005 4 PLC ±.002 ANGLES ±.020 FINISH		APVD: M. PERCHERKE	NAME: PRODUCT SPEC
MATERIAL:		108-1973	SIZE: CAGE CODE DRAWING NO. RESTRICTED TO
		114-13038	A100779C=6450330
		WEIGHT:	SCALE: 1:1 SHEET 4 OF 19 REV: P.9
		CUSTOMER DRAWING	

LOC	DIST	REVISIONS			
P	LTN	DESCRIPTION	DATE	DMN	APVD
ES	00	SEE SHEET 1			

PART NUMBER	ROWS	POWER			SIGNAL						POWER							
		P1	P2	P3	1	2	3	4	5	6	P4	P5	P6	P7	P8	P9		
6450330-7	D C B A	PM	PM	PM	J	J	J	J	J	J	PM	PM	PM	PM	PM	PM	PM	PM
					K	K	K	K	K	K								
					N	N	N	N	N	N								
						H		S		S		S						
3ACP + 24S + 6P																		

PART NUMBER	ROWS	POWER				SIGNAL					POWER				
		P1	P2	P3	P4	1	2	3	4	5	P5	P6	P7	P8	
6450330-9	D C B A	PM	PM	PM	PM	J	J	J	J	J	PM	PM	PM	PM	PM
						K	K	K	K	K					
						N	N	G	N	N					
						S		S		S					
4P + 20S + 4P															

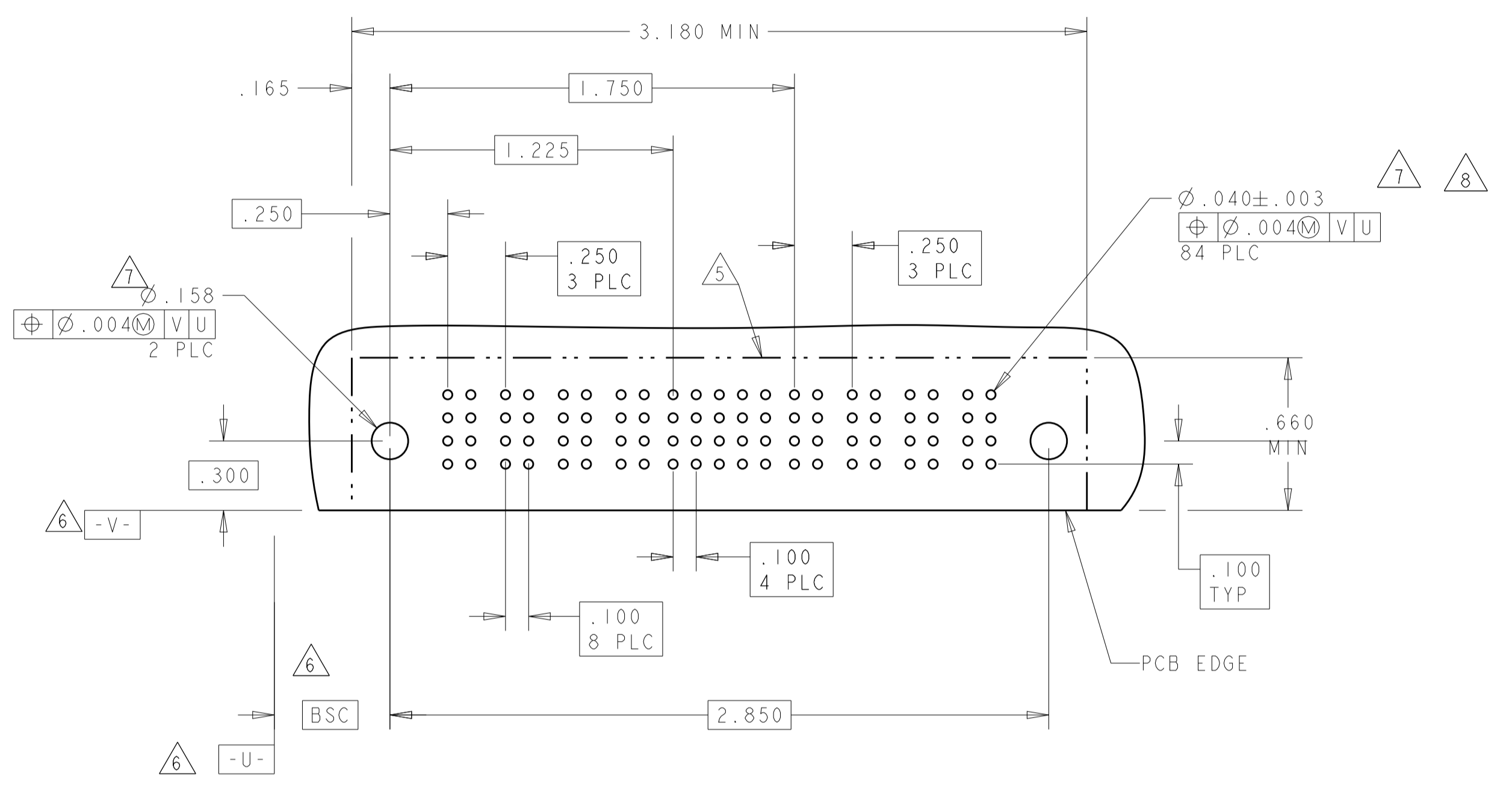
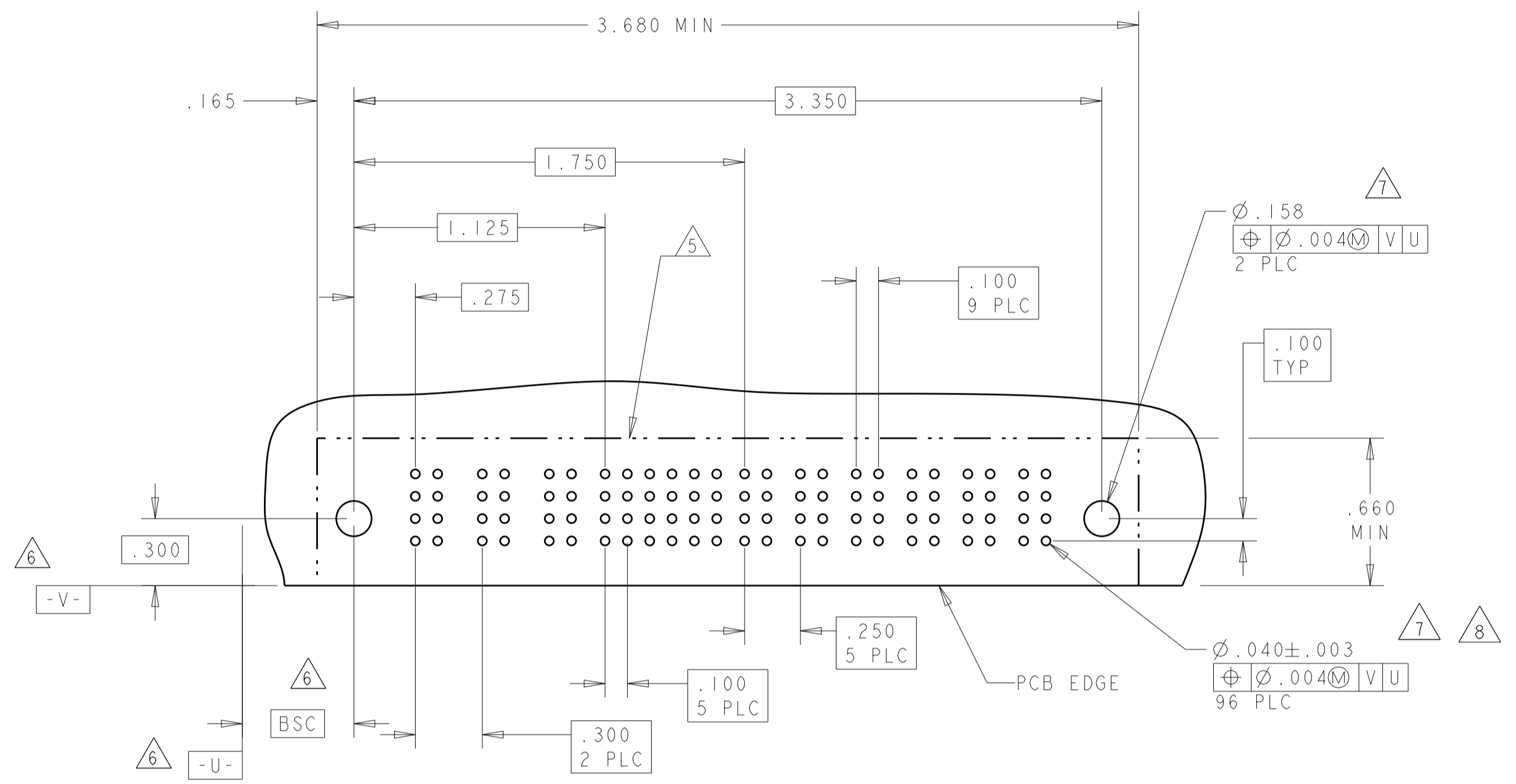

PART NUMBER	ROWS	POWER		SIGNAL						POWER			
		P1	P2	1	2	3	4	5	6	P1	P2		
6450330-8	D C B A	PM	PM	J	J	J	J	J	J	PM	PM	PM	PM
				K	K	K	K	K	K				
				N	N	G	G	N	G				
				S		H		S		S			
1P + 24S + 1P													

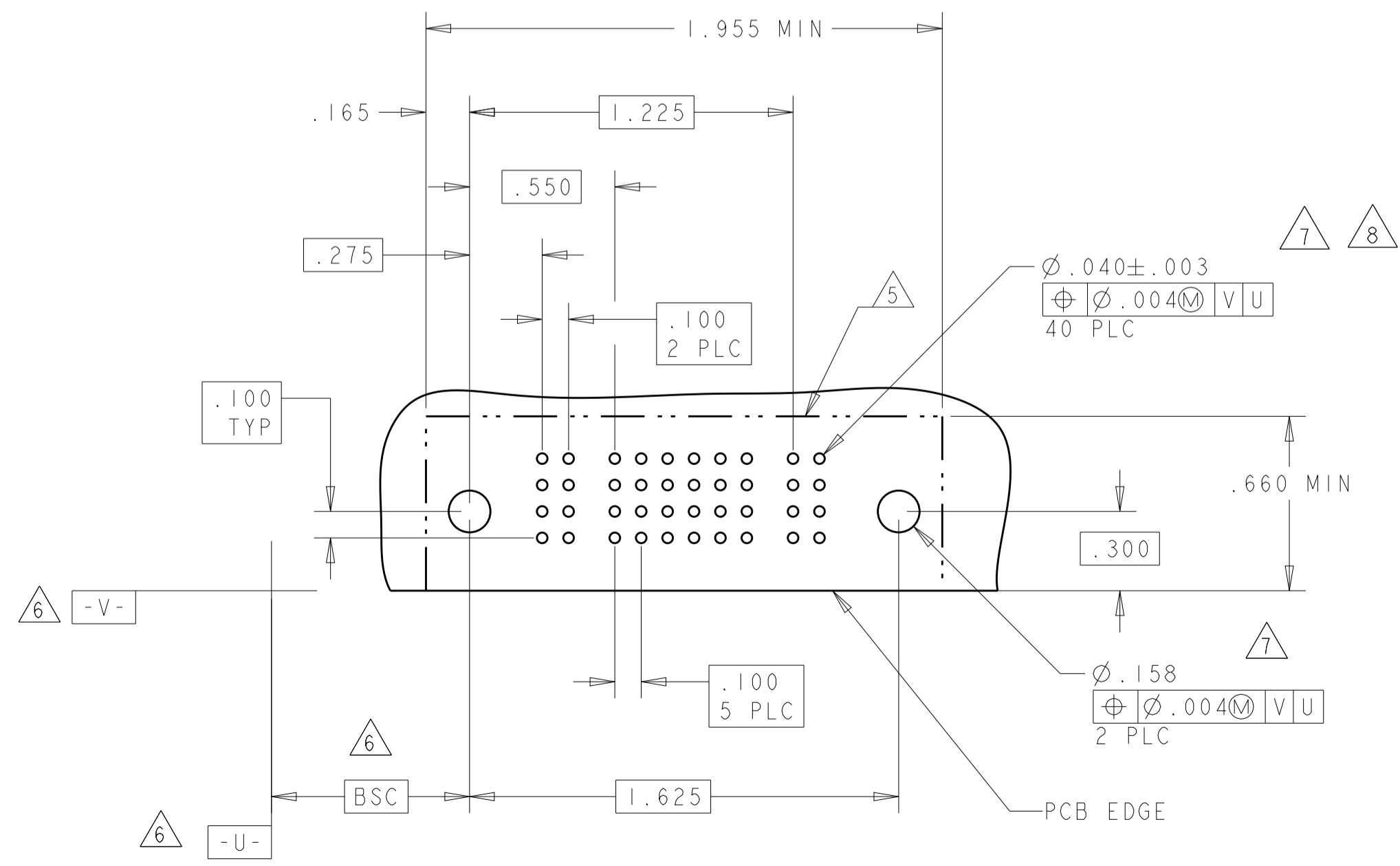

THIS DRAWING IS A CONTROLLED DOCUMENT.		DMN: R. GRZYBOWSKI 28FEB05	TE Connectivity RIGHT ANGLE HEADER ASSEMBLY SOLDER TAILS, W/GUIDES MULTI-BEAM XL
DIMENSIONS: INCHES		CHK: M. PERCHERKE 28FEB05	
DIMENSIONS: INCHES 0 PLC ±. 1 PLC ±.01 2 PLC ±.01 3 PLC ±.005 4 PLC ±.002 ANGLES ±.2°		TOLERANCES UNLESS OTHERWISE SPECIFIED: APVD: M. PERCHERKE PRODUCT SPEC: 108-1973 APPLICATION SPEC: 114-13038 WEIGHT: - FINISH: -	
MATERIAL:		SIZE: A100779	CAGE CODE: C=6450330 DRAWING NO: - RESTRICTED TO: - SCALE: 1:1 SHEET: 5 OF 19 REV: P.9
CUSTOMER DRAWING			

LOC	DIST	REV	DATE	APPV
ES	00			

PART NUMBER	ROWS	POWER						SIGNAL						POWER					
		P1	P2	P3	P4	P5	P6	P7	1	2	3	4	5	6	P8	P9	P10	P11	P12
I-6450330-0	D C B A	PM	PM	PM	PM	PM	PM	J	J	J	J	J	J	PM	PM	PM	PM	PM	PM
		K	K	K	K	K	K	N	N	N	N	N	N						
		S	S	S	S	S	S	S	S	S	S	S	H						

PART NUMBER	ROWS	POWER						SIGNAL						POWER		
		P1	1	2	3	4	5	6	P2	1	2	3	4	5	6	P2
I-6450330-1	D C B A	PM							J	J	J	J	J	J	PM	PM
		F	K	K	K	K	K	F	N	N	N	N	N	N		
		N	N	N	N	N	N	N	S	S	S	S	S	S		

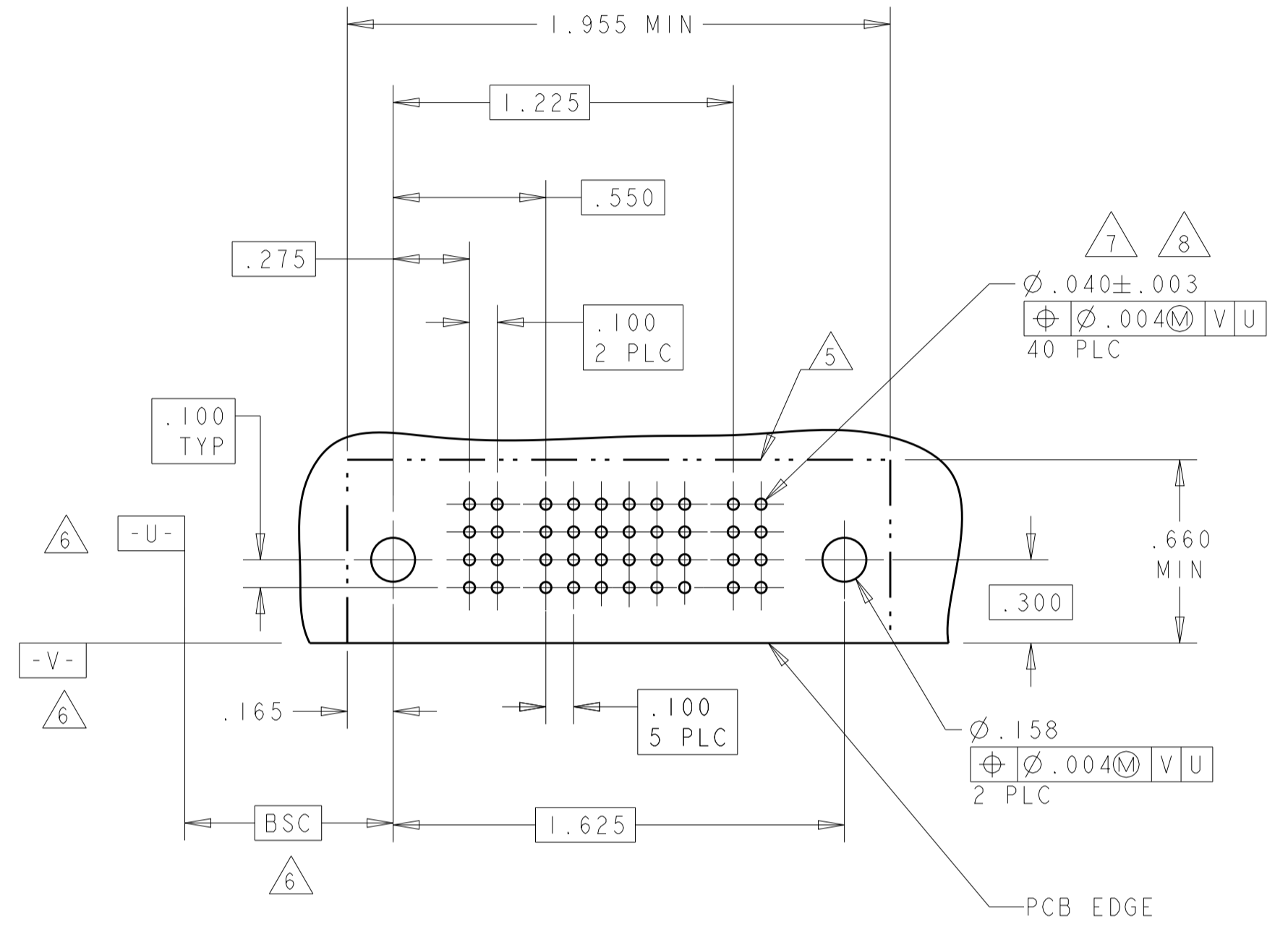
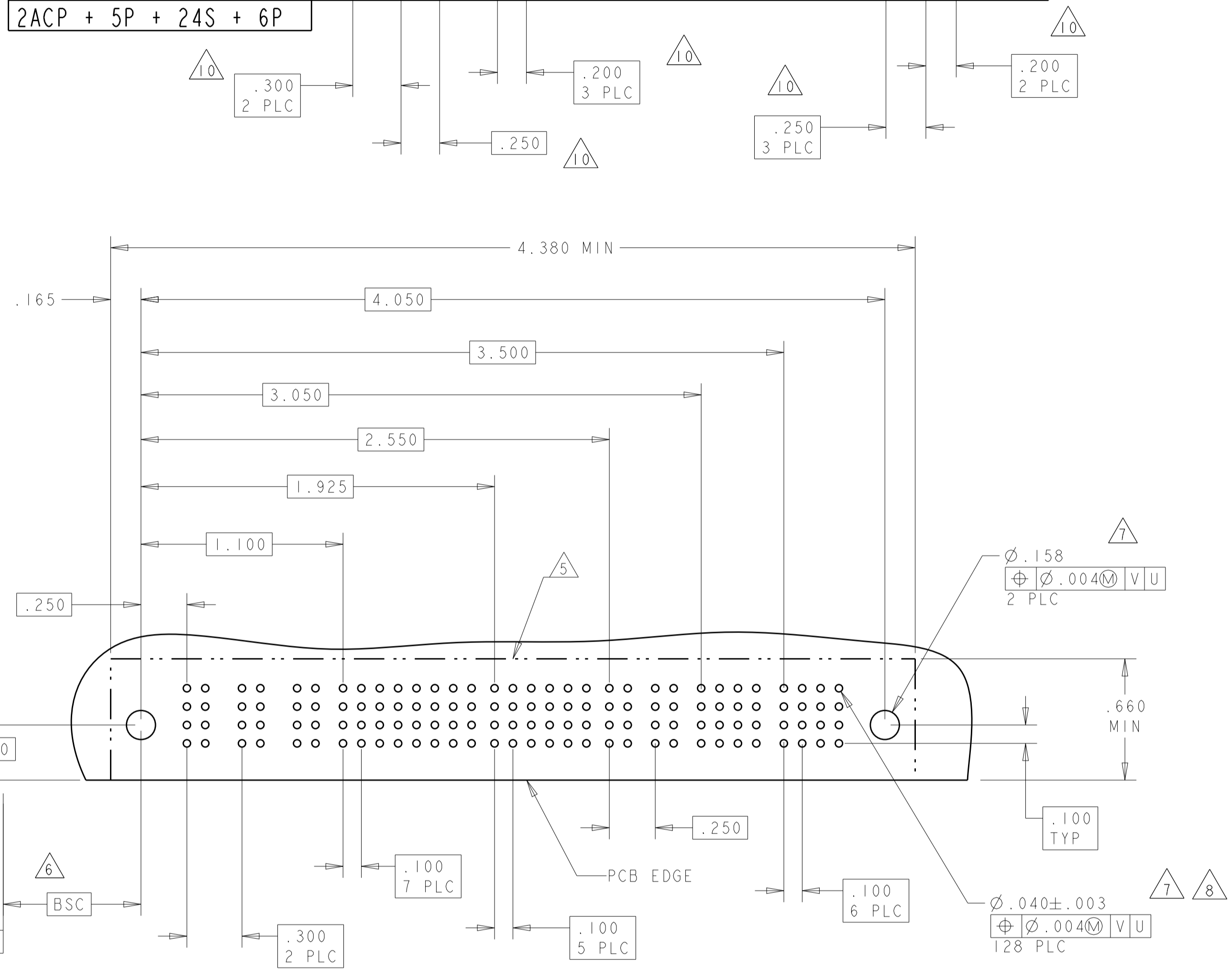

PART NUMBER	ROWS	SIGNAL					
		1	2	3	4	5	6
I-6450330-2	D C B A	Z	Z	Z	Z	Z	Z
		Y	Y	Y	Y	Y	Y
		O	O	O	O	O	O

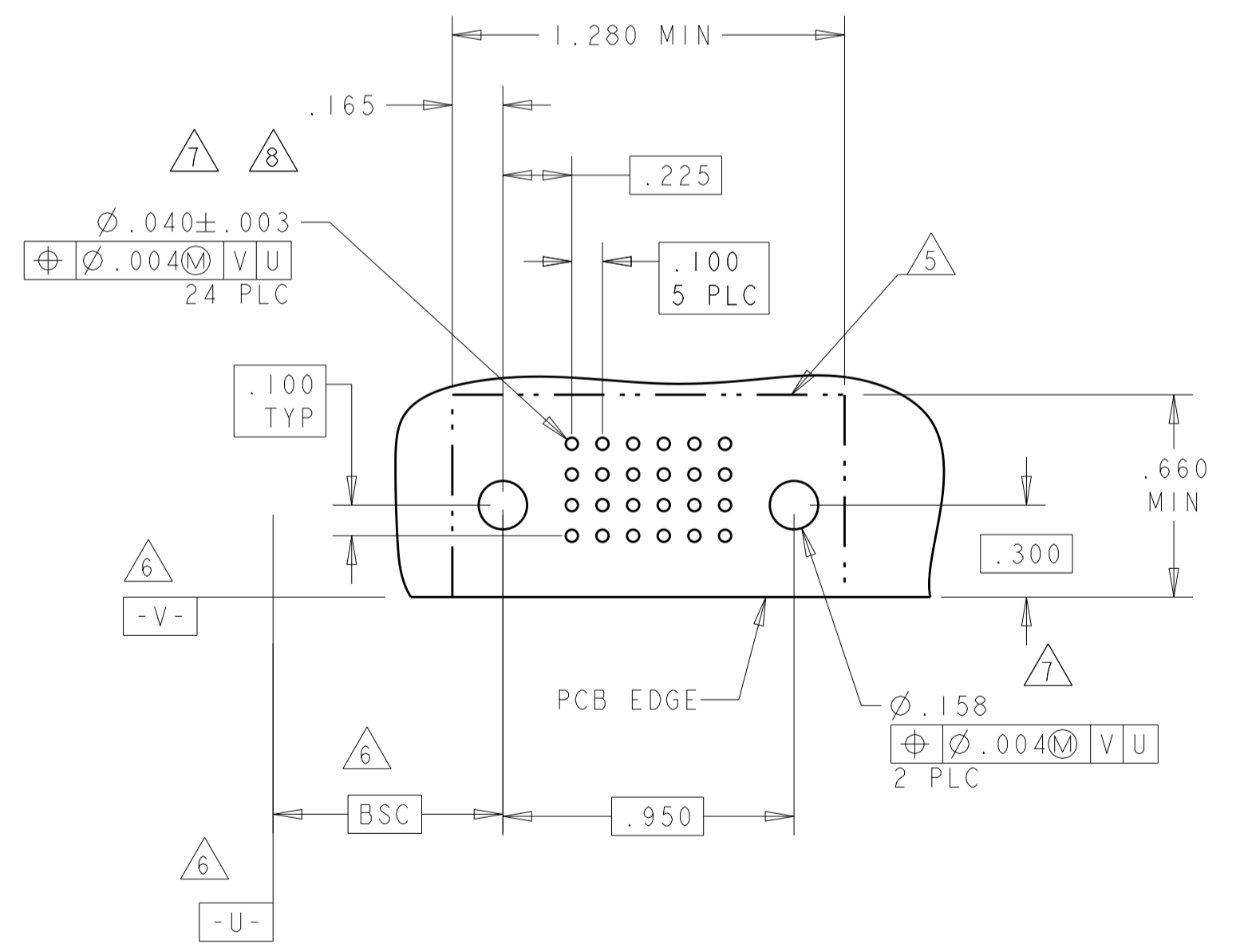

THIS DRAWING IS A CONTROLLED DOCUMENT. DWN: R. GRZYBOWSKI 28FEB05
 CHK: M. PERCHERKE 28FEB05

TE Connectivity

RIGHT ANGLE HEADER ASSEMBLY
 SOLDER TAILS, W/GUIDES
 MULTI-BEAM XL

SCALE: 1:1 SHEET 6 OF 19 REV: P.9

LOC	DIST	REV	DATE	APPV
ES	00			

PART NUMBER	ROWS	POWER					SIGNAL						POWER			
		P1	P2	P3	P4	P5	1	2	3	4	5	6	P6	P7	P8	P9
I-6450330-3	D C B A	PA	PA	PA	PA	PA	Z	Z	Z	Z	Z	Z	PA	PA	PA	PA
		Y	Y	Y	Y	Y	R	R	R	R	R					
		A1	A1	A1	A1		O	O								
5P + 24S + 4P																

PART NUMBER	ROWS	POWER				SIGNAL							POWER			
		P1	P2	P3	P4	1	2	3	4	5	6	7	P5	P6	P7	P8
I-6450330-8	D C B A	PM	PM	PM	PM	J	J	J	J	J	J	J	PM	PM	PM	PM
		K	K	K	K	K	K	K								
		N	N	N	G	N	N	N								
4P + 28S + 4P																

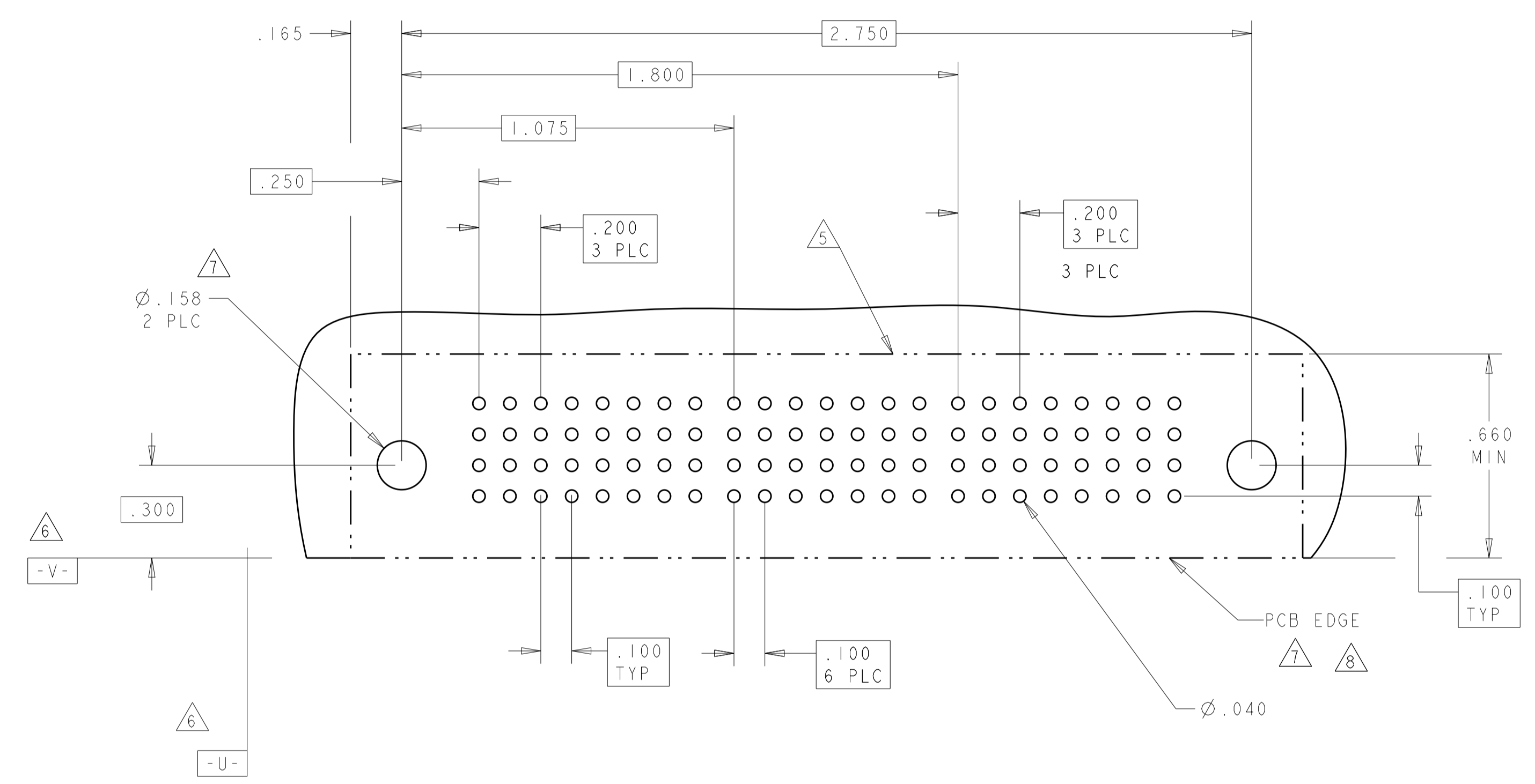
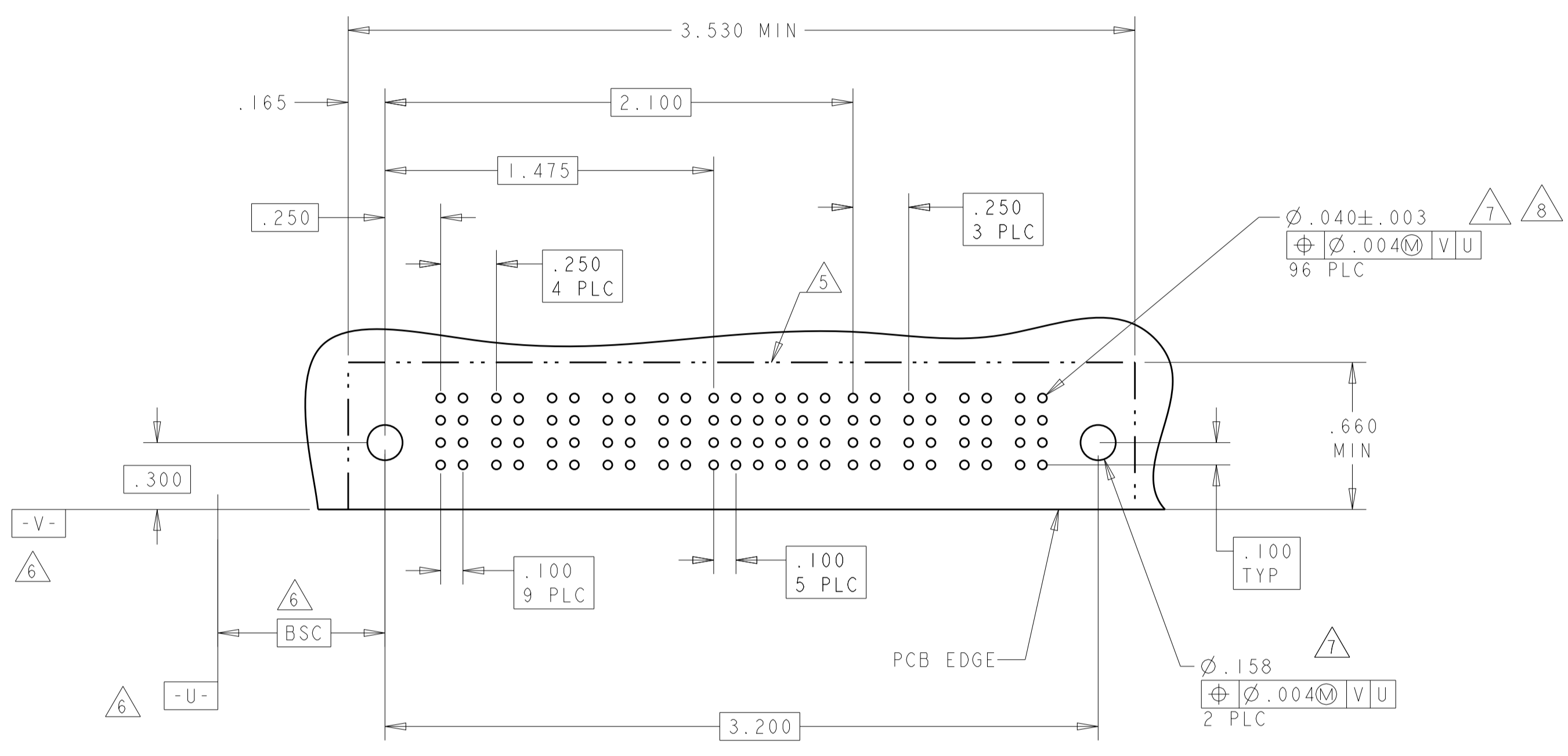

PART NUMBER	ROWS	POWER		SIGNAL						POWER	
		P1	P2	1	2	3	4	5	6	P3	P4
I-6450330-4	D C B A	PM	PM	J	J	E	J	J	J	PM	PM
		K	K	K	K	K	K				
		N	N	G	N	N	N				
2P + 24S + 2P											

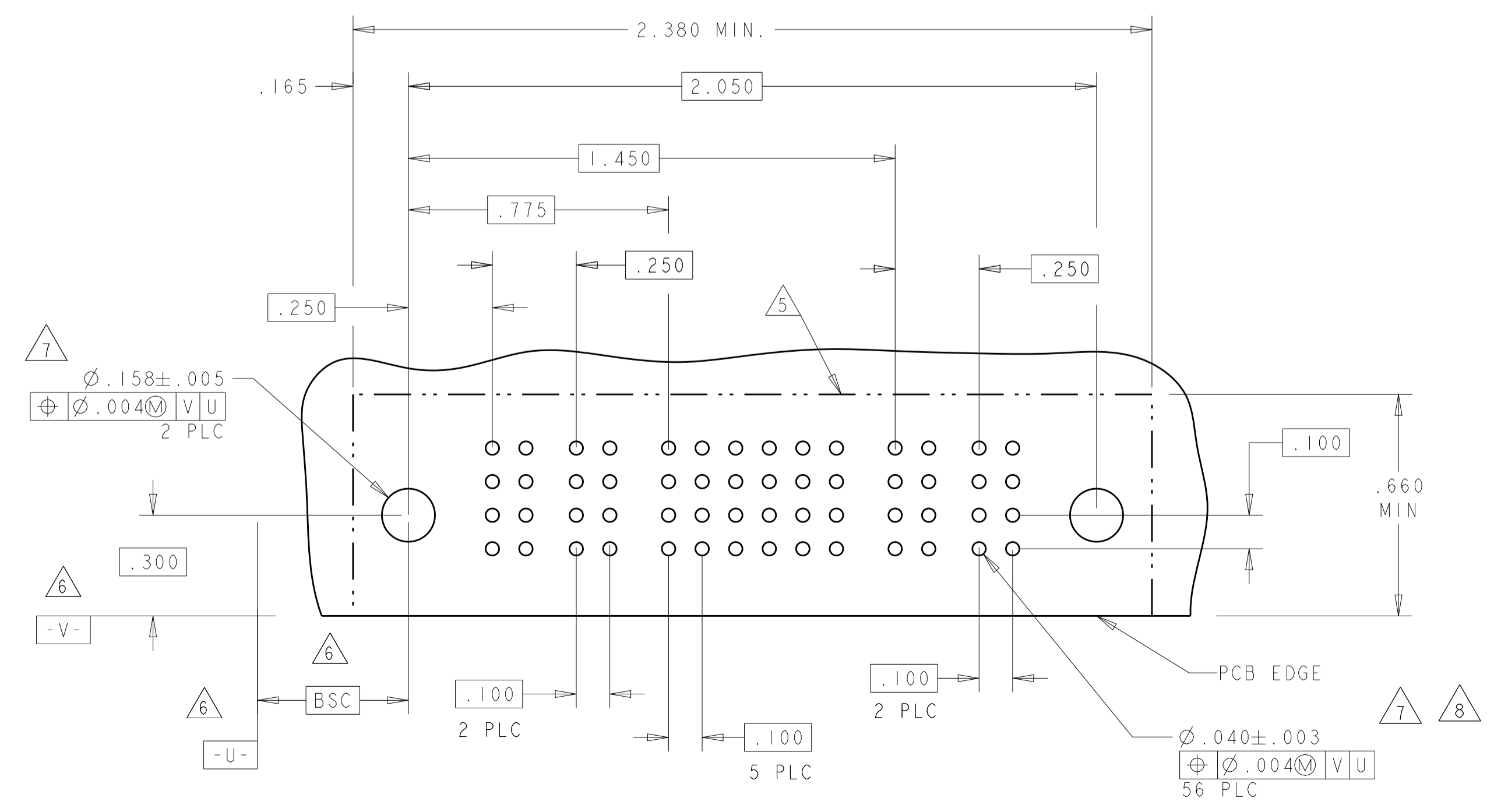

THIS DRAWING IS A CONTROLLED DOCUMENT.		OWN: R. GRZYBOWSKI 28FEB05	TE Connectivity
DIMENSIONS: INCHES		CHK: M. PERCHERKE 28FEB05	
TOLERANCES UNLESS OTHERWISE SPECIFIED:		APVD: M. PERCHERKE	NAME: RIGHT ANGLE HEADER ASSEMBLY SOLDER TAILS, W/GUIDES MULTI-BEAM XL
0 PLC ± .01 1 PLC ± .01 2 PLC ± .01 3 PLC ± .005 4 PLC ± .002 ANGLES ± .2°		PRODUCT SPEC: 108-1973	APPLICATION SPEC: 114-13038
MATERIAL: FINISH:		WEIGHT: 114-13038	RESTRICTED TO: A100779
CUSTOMER DRAWING		SCALE: 1:1	SHEET 7 OF 19 REV P.9

LOC	DIST	REV	DATE	APPD
ES	00			

REVISIONS			
REV	DATE	APPD	DESCRIPTION
-	-	-	SEE SHEET 1

PART NUMBER	ROWS	POWER				SIGNAL										POWER					
		P1	P2	P3	P4	1	2	3	4	5	6	7	8	9	10	P5	P6	P7	P8		
2-6450330-3	D C B A	PM	PM	PM	PM	J	J	J	J	J	J	J	J	J	J	J	J	J	J	J	
						K	K	K	K	K	K	K	K	K	K	K	K	K	K	K	
						N	N	N	N	N	N	N	N	N	N	N	N	N	N	N	N
						H	S	S	S	S	S	S	S	S	S	S	S	S	S	S	H
4P + 40S + 4P																					

PART NUMBER	HOUSING P/N	ROWS	POWER		SIGNAL		POWER	
			P1	P2	1	2	P3	P4
4-6450330-6	4-1450310-5	D C B A	PM	PM	J	J	PM	PM
					K	K		
					N	N		
					S	S		
2P + 8S + 2P								

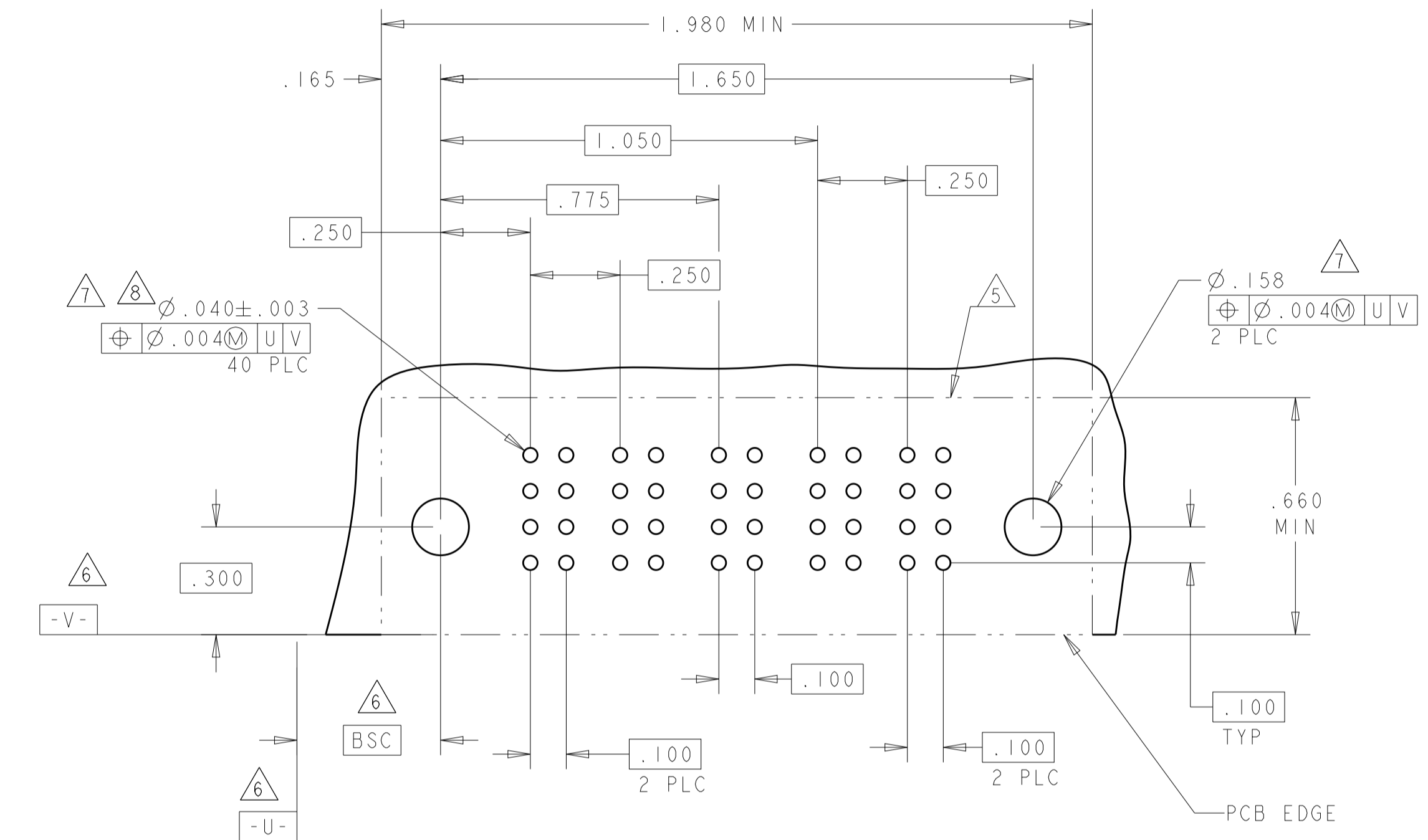
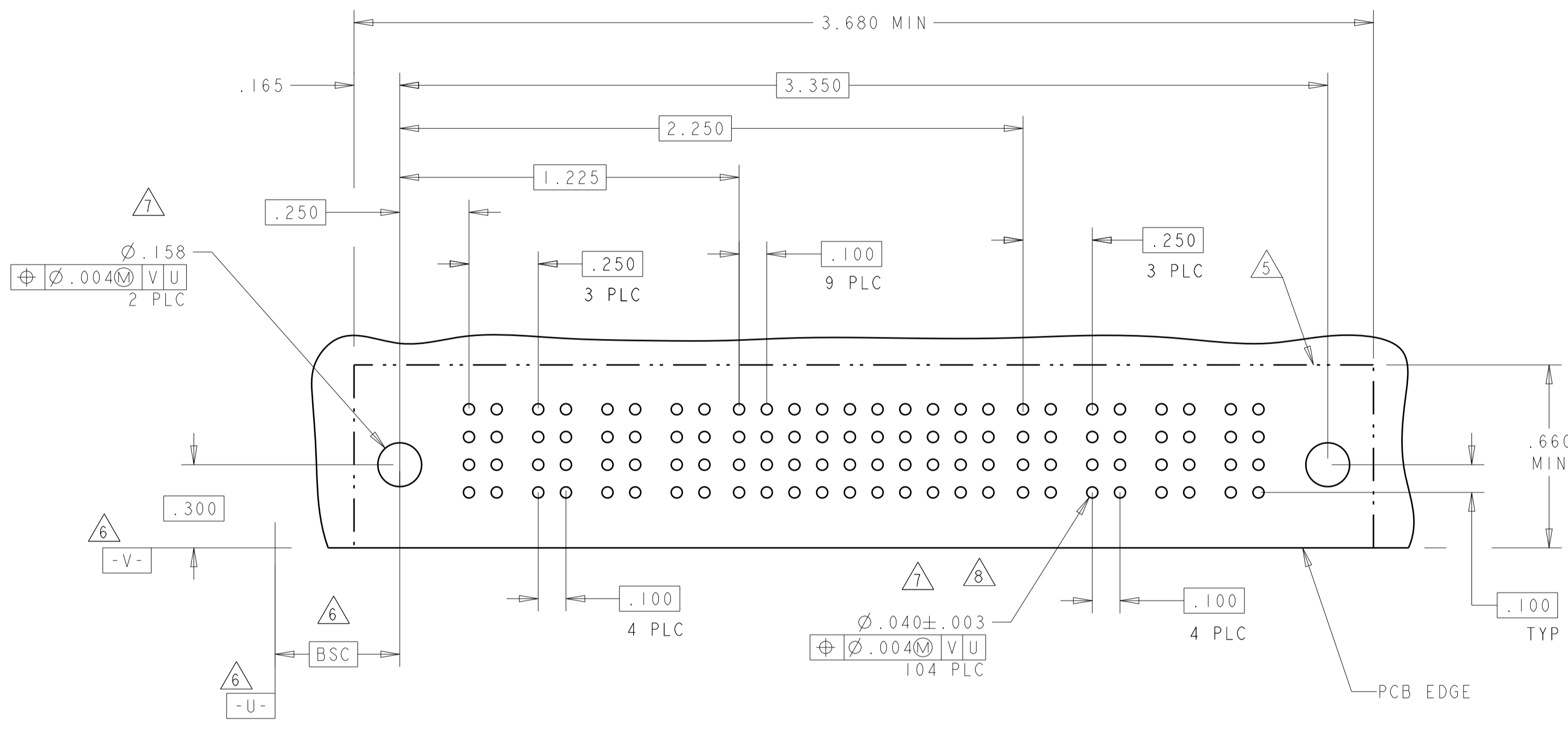

PART NUMBER	ROWS	POWER			SIGNAL						POWER				
		P1	P2	P3	1	2	3	4	5	6	P4	P5	P6	P7	
2-6450330-8	D C B A	PM	PM	PM	J	J	J	J	J	J	PM	PM	PM	PM	
					K	K	K	K	K	K					
					N	N	N	N	N	N	N				
					H	S	S	S	S	S	S				
3ACP + 24S + 4P															

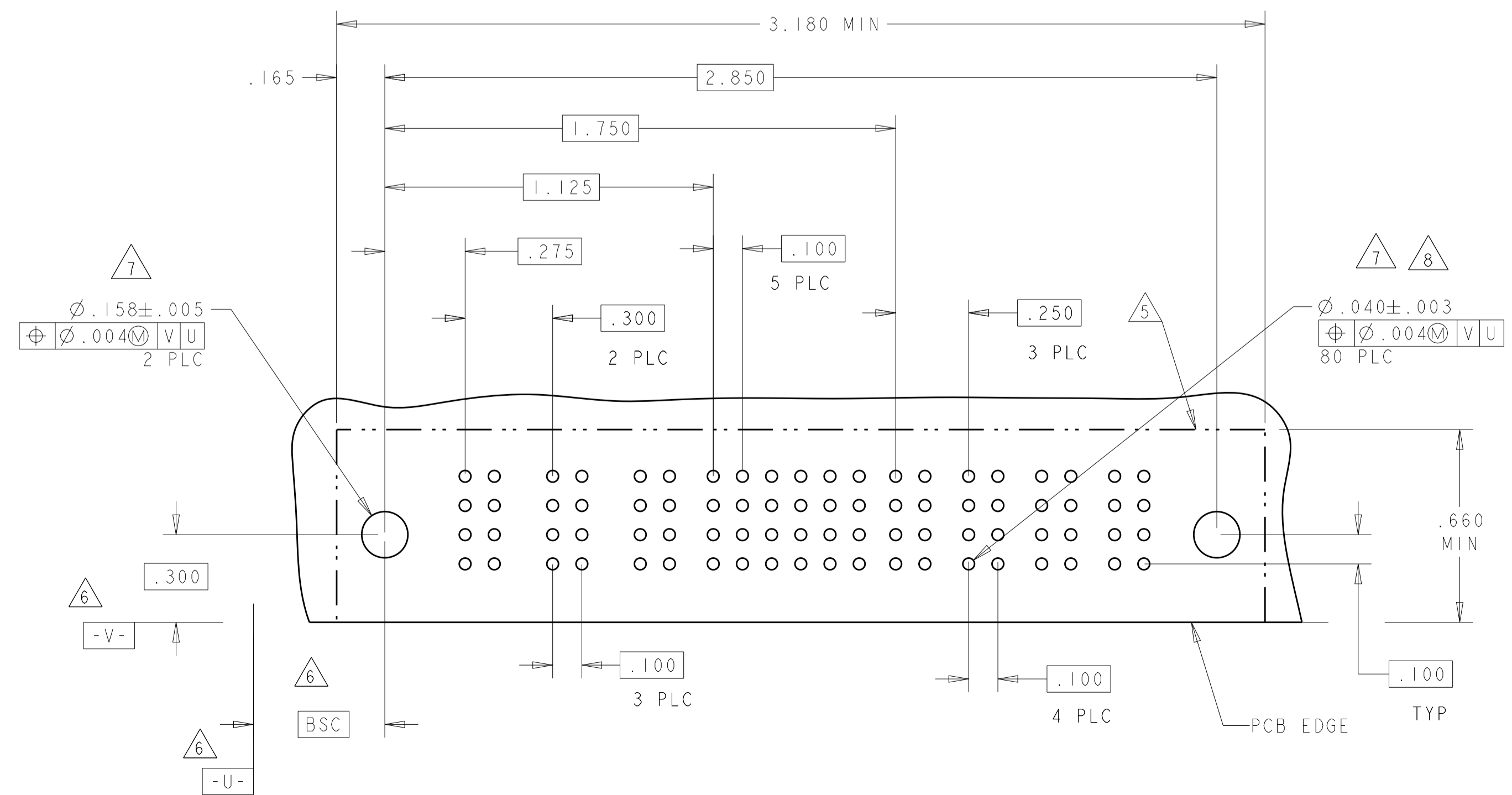

THIS DRAWING IS A CONTROLLED DOCUMENT.

DIMENSIONS: INCHES	TOLERANCES UNLESS OTHERWISE SPECIFIED:	OWN: R. GRZYBOWSKI 28FEB05	CHK: M. PERCHERKE 28FEB05	APVD: M. PERCHERKE	NAME: M. PERCHERKE	PRODUCT SPEC: 108-1973	APPLICATION SPEC: 114-13038	WEIGHT: -	SCALE: 1:1	SHEET: 8 OF 19	REV: P.9
--------------------	--	----------------------------	---------------------------	--------------------	--------------------	------------------------	-----------------------------	-----------	------------	----------------	----------

STE TE Connectivity

RIGHT ANGLE HEADER ASSEMBLY
SOLDER TAILS, W/GUIDES
MULTI-BEAM XL

SIZE: A1 00779 C=6450330

CUSTOMER DRAWING

PART NUMBER	ROWS	POWER			SIGNAL						POWER		
		P1	P2	P3	1	2	3	4	5	6	P4	P5	P6
3-6450330-9	D	PM	PM	PM	J	E	E	E	E	E	PM	PM	PM
	C				F	F	F	F	F	K			
	B				G	G	G	G	G	N			
	A				H	H	H	H	H	H			
3P + 24S + 3P													

PART NUMBER	ROWS	POWER		SIGNAL				POWER	
		P1	P2	1	2	3	4	P3	P4
4-6450330-9	D	PM	PM	J	E	J	J	PM	PM
	C			K	F	K	K		
	B			N	G	N	N		
	A			S	H	S	S		
2P + 16S + 2P									

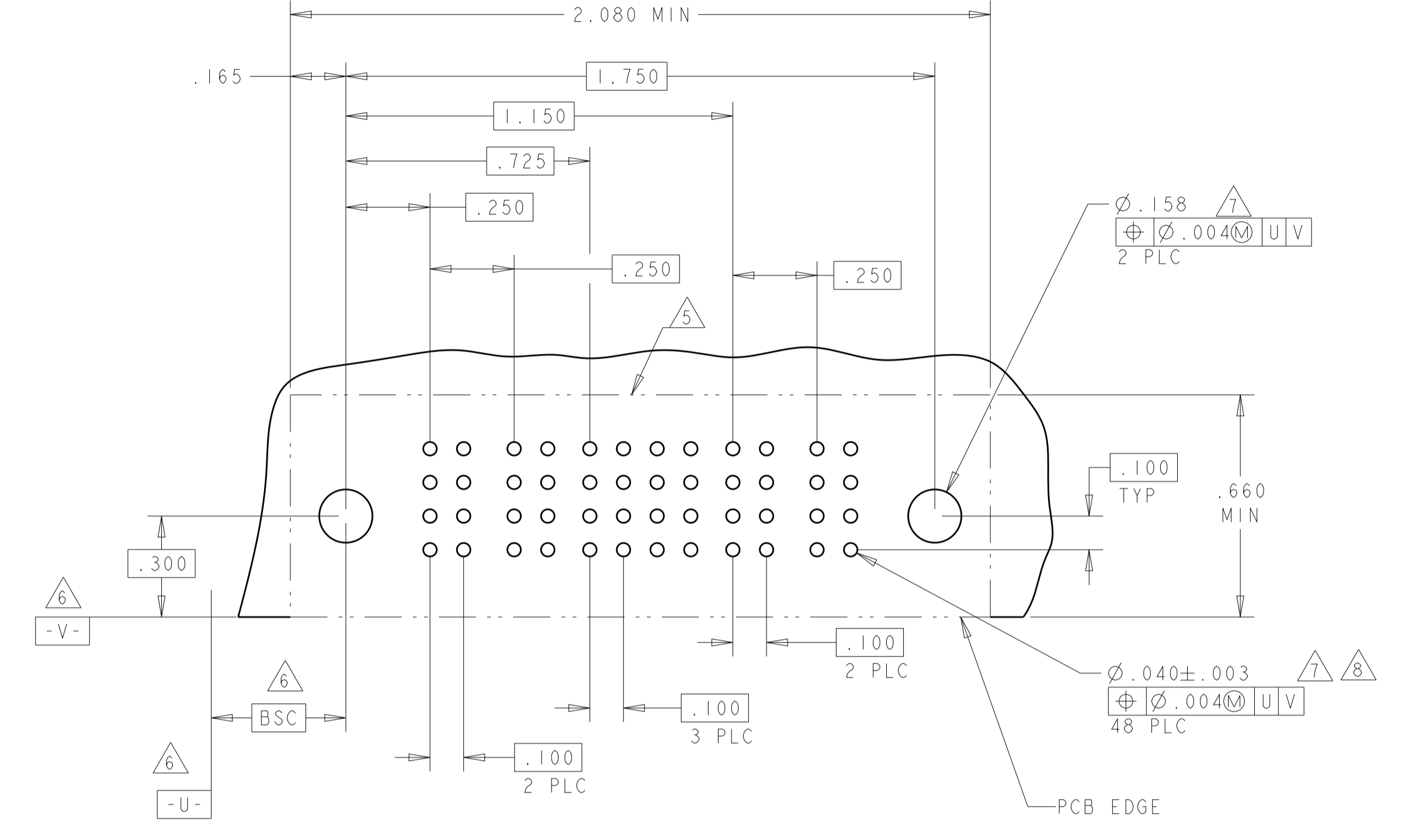
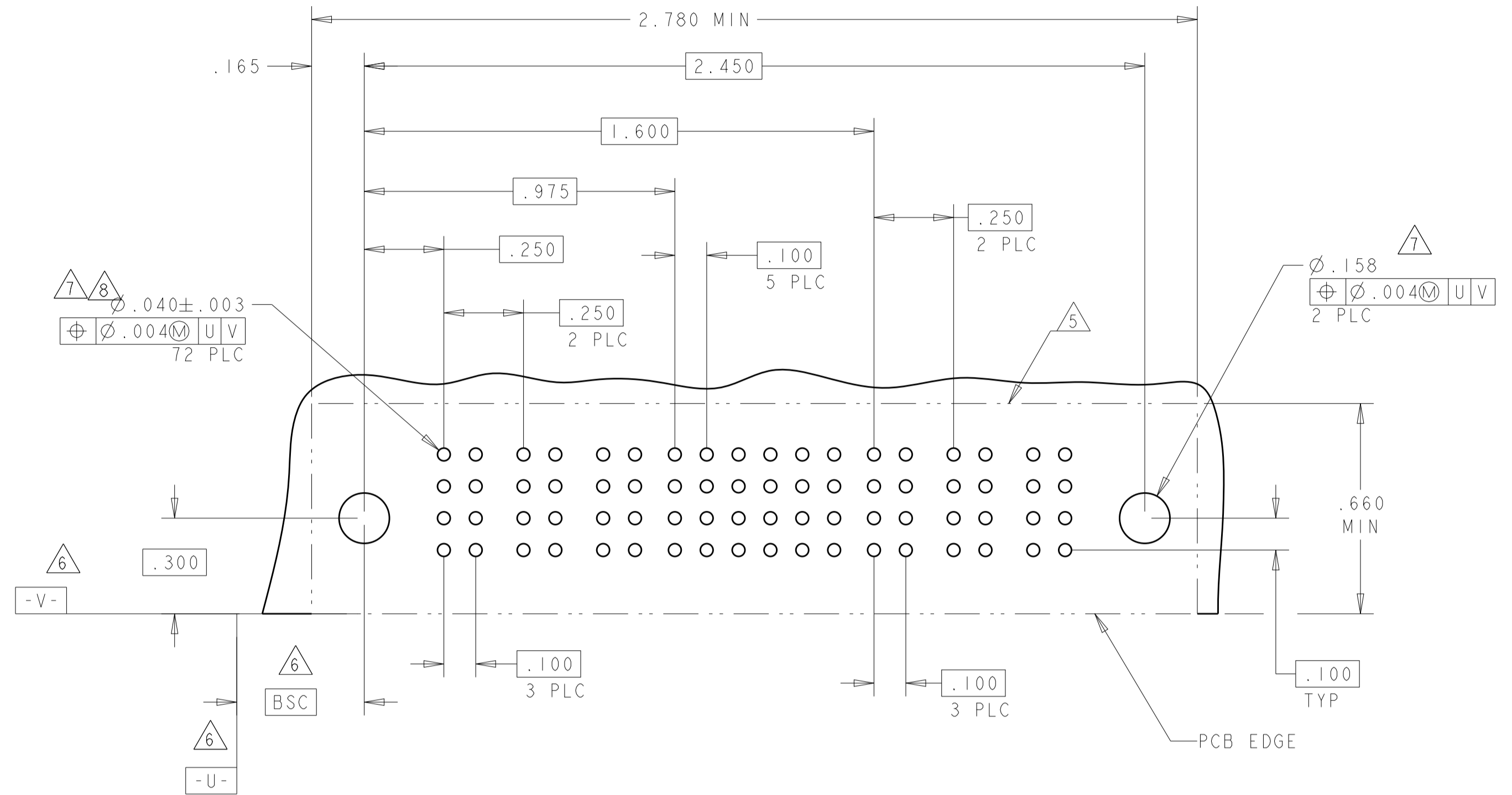

PART NUMBER	ROWS	POWER				SIGNAL						POWER	
		P1	P2	P3	P4	1	2	3	4	5	6	P5	P6
4-6450330-2	D	PM	PM	PM	PM	J	J	J	J	J	J	PM	PM
	C					F	K	K	K	K			
	B					N	N	N	N	N			
	A					S	S	S	S	S			
4P + 24S + 2P													

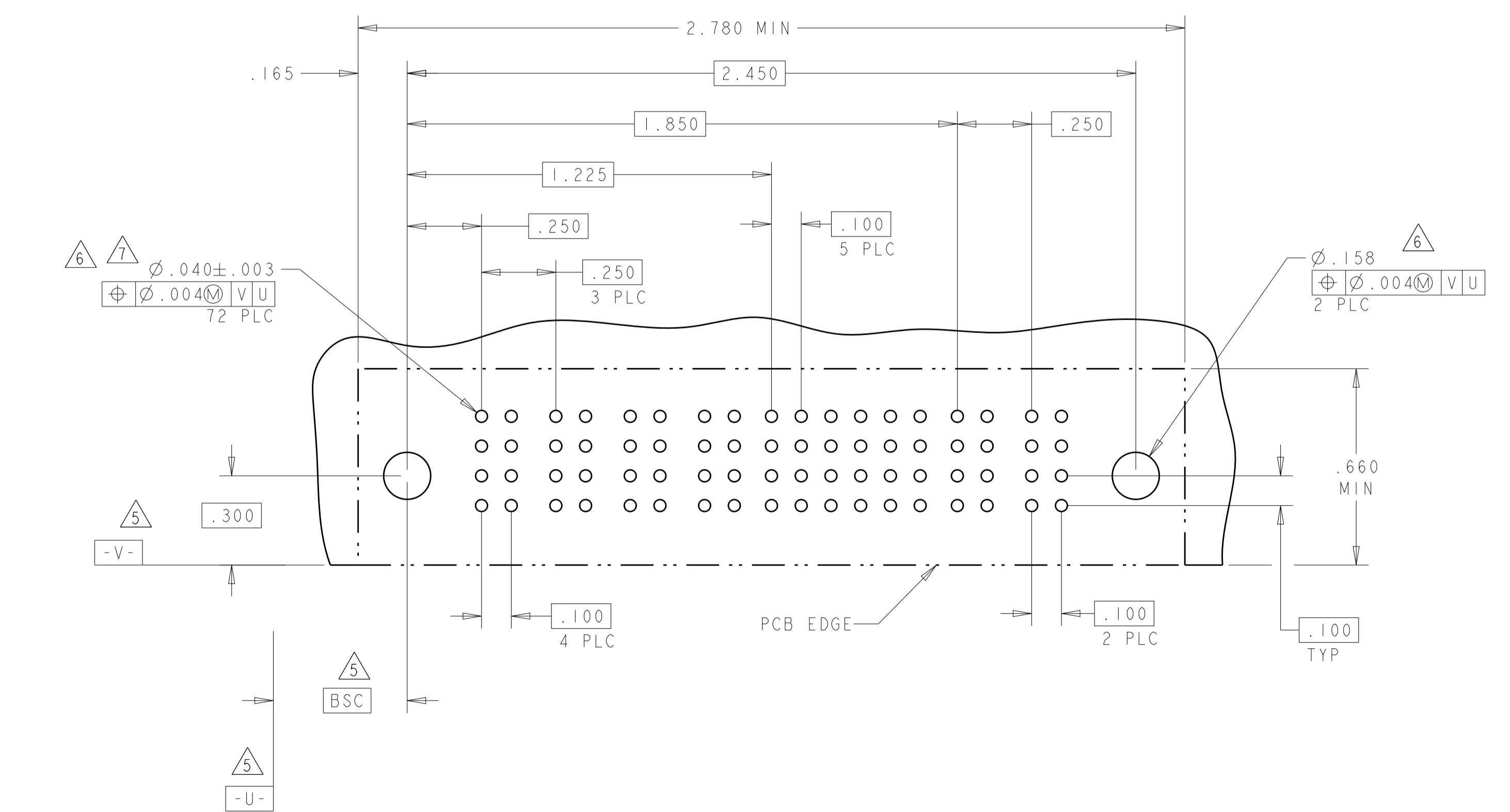

THIS DRAWING IS A CONTROLLED DOCUMENT.		DWN: R. GRZYBOWSKI 28FEB05	 TE Connectivity
DIMENSIONS: INCHES		CHK: M. PERCHERKE 28FEB05	
TOLERANCES UNLESS OTHERWISE SPECIFIED:		APVD: M. PERCHERKE	NAME: RIGHT ANGLE HEADER ASSEMBLY SOLDER TAILS, W/GUIDES MULTI-BEAM XL
0 PLC ±.01 1 PLC ±.01 2 PLC ±.01 3 PLC ±.005 4 PLC ±.002 ANGLES ±.020		PRODUCT SPEC: 108-1973	APPLICATION SPEC: 114-13038
MATERIAL: FINISH: *		WEIGHT: -	RESTRICTED TO: -
CUSTOMER DRAWING		SCALE: 1:1	SHEET 9 OF 19 REV P.9

PART NUMBER	ROWS	POWER				SIGNAL						POWER		
		P1	P2	P3	P4	1	2	3	4	5	6	P5	P6	P7
5-6450330-0	D C B A	PM	PM	PM	PM	J	J	J	J	J	J	PM	PM	PM
						K	K	K	K	K	K			
						N	N	N	N	N	N			
						S	S	S	S	S	H			
4P + 24S + 3ACP														

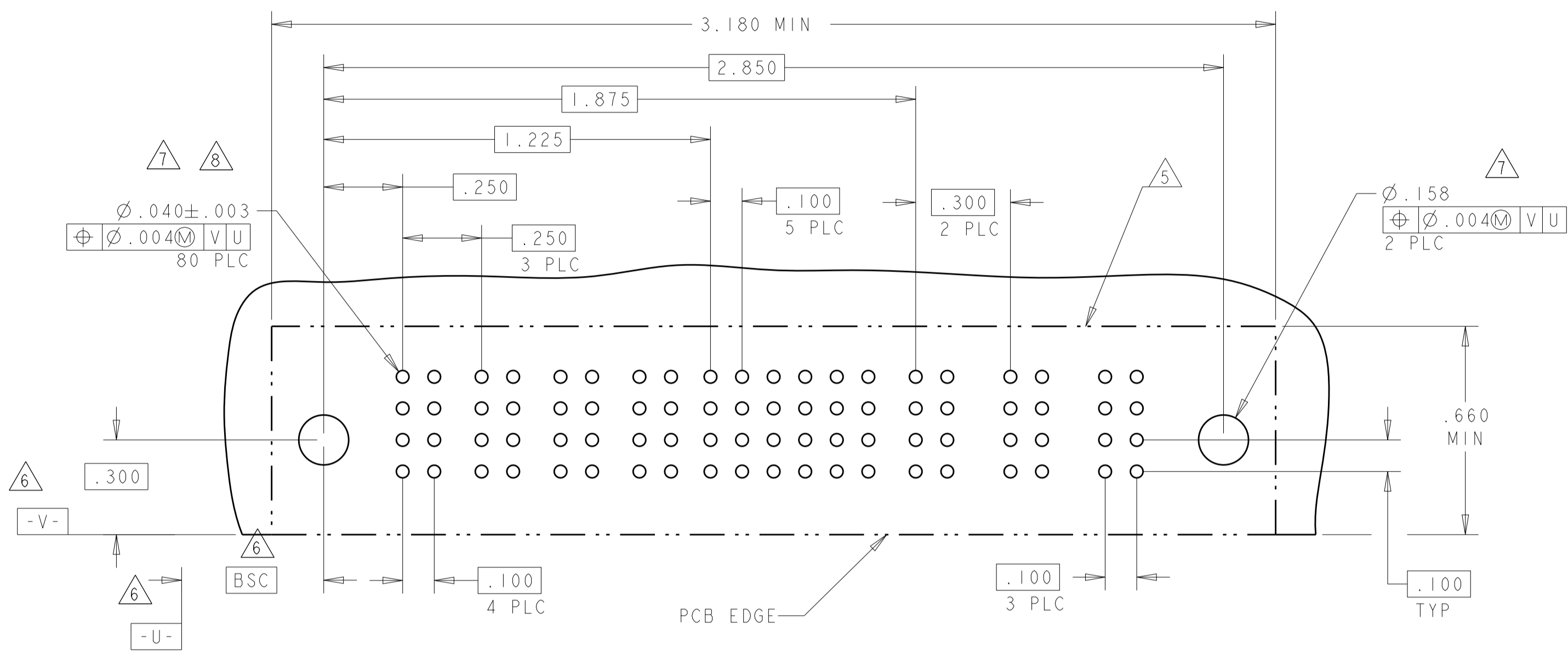

PART NUMBER	ROWS	POWER		SIGNAL				POWER	
		P1	P2	1	2	3	4	P3	P4
5-6450330-1	D C B A	PM	PM	J	J	J	E	PM	PM
				K	K	K	K		
				N	G	N	N		
				S	S	S	S		
2P + 16S + 2P									

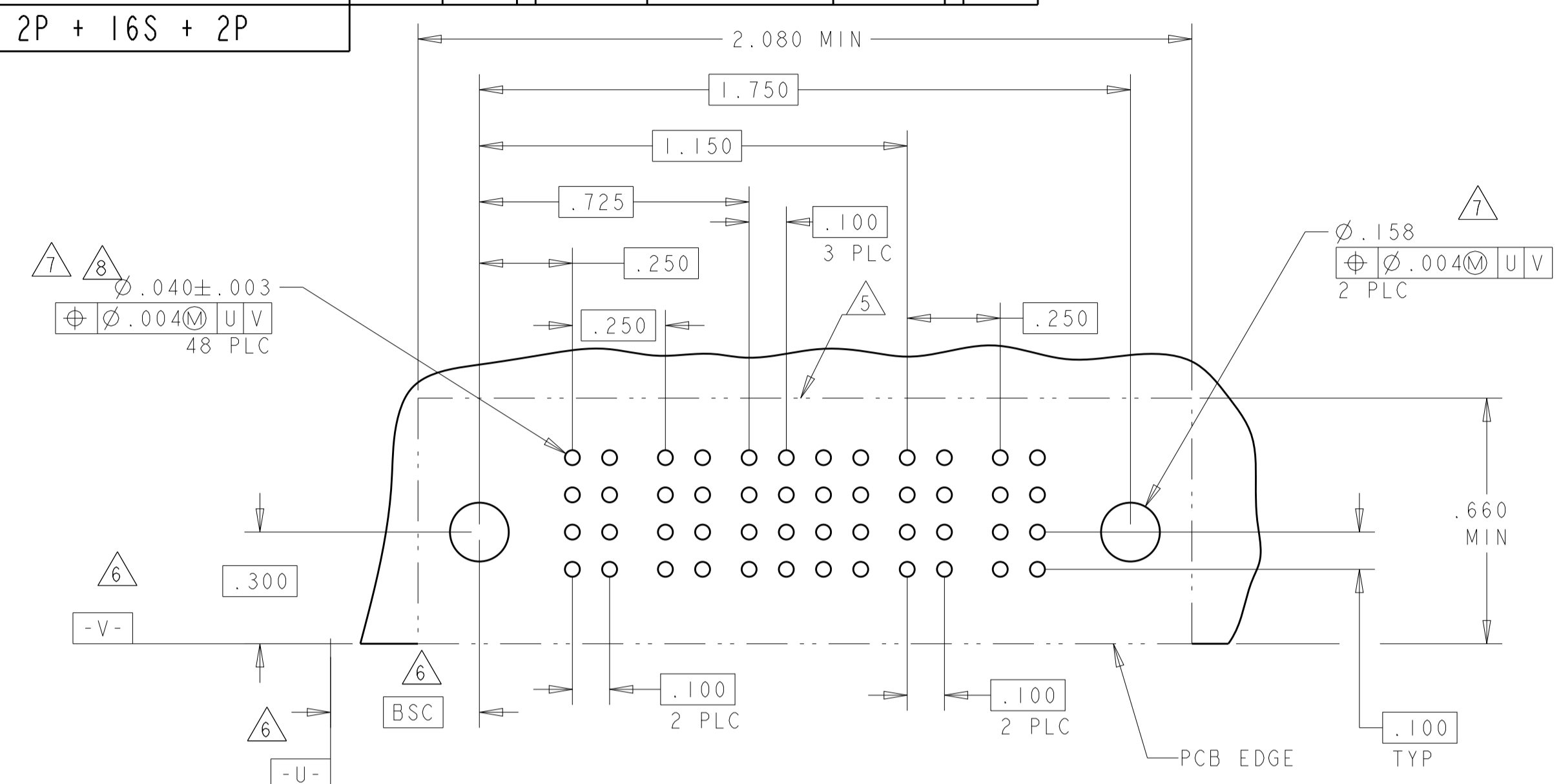

PART NUMBER	ROWS	POWER			SIGNAL						POWER		
		P1	P2	P3	1	2	3	4	5	6	P4	P5	P6
2-6450330-6	D C B A	PM	PM	PM	J	J	E	J	J	J	PM	PM	PM
					K	K	K	K	K	K			
					N	N	N	N	N	N			
					S	S	S	S	S	S			
3ACP + 24S + 3ACP													

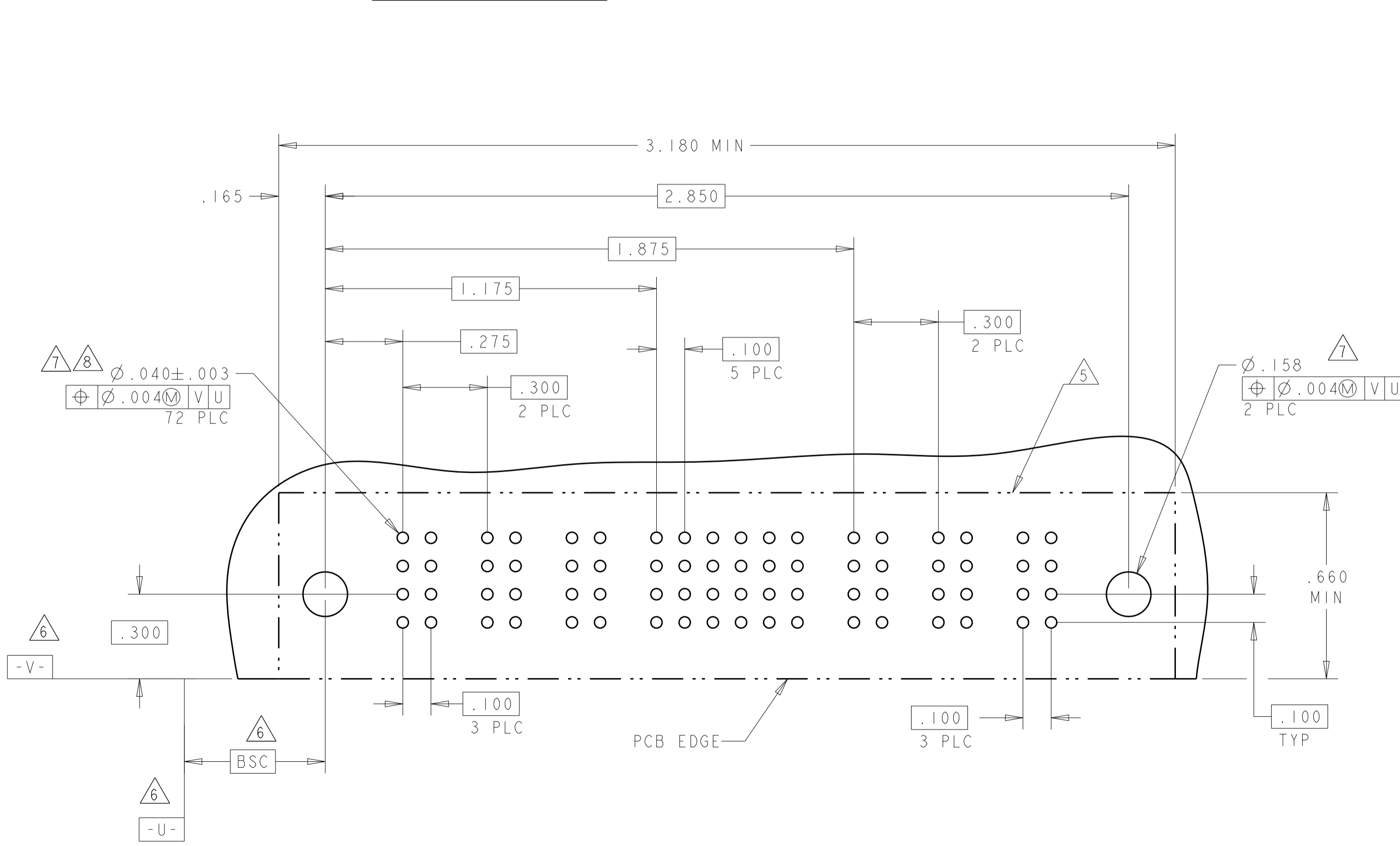

PART NUMBER	ROWS	POWER				SIGNAL						POWER			
		P1	P2	P3	P4	1	2	3	4	5	6	P5	P6	P7	P8
5-6450330-3	D C B A	PM	PM	PM	PM	J	J	J	J	J	J	PM	PM	PM	PM
						K	K	K	K	K	K				
						N	N	N	N	N	N				
						S	S	S	S	S	H				
4P + 24S + 4P															

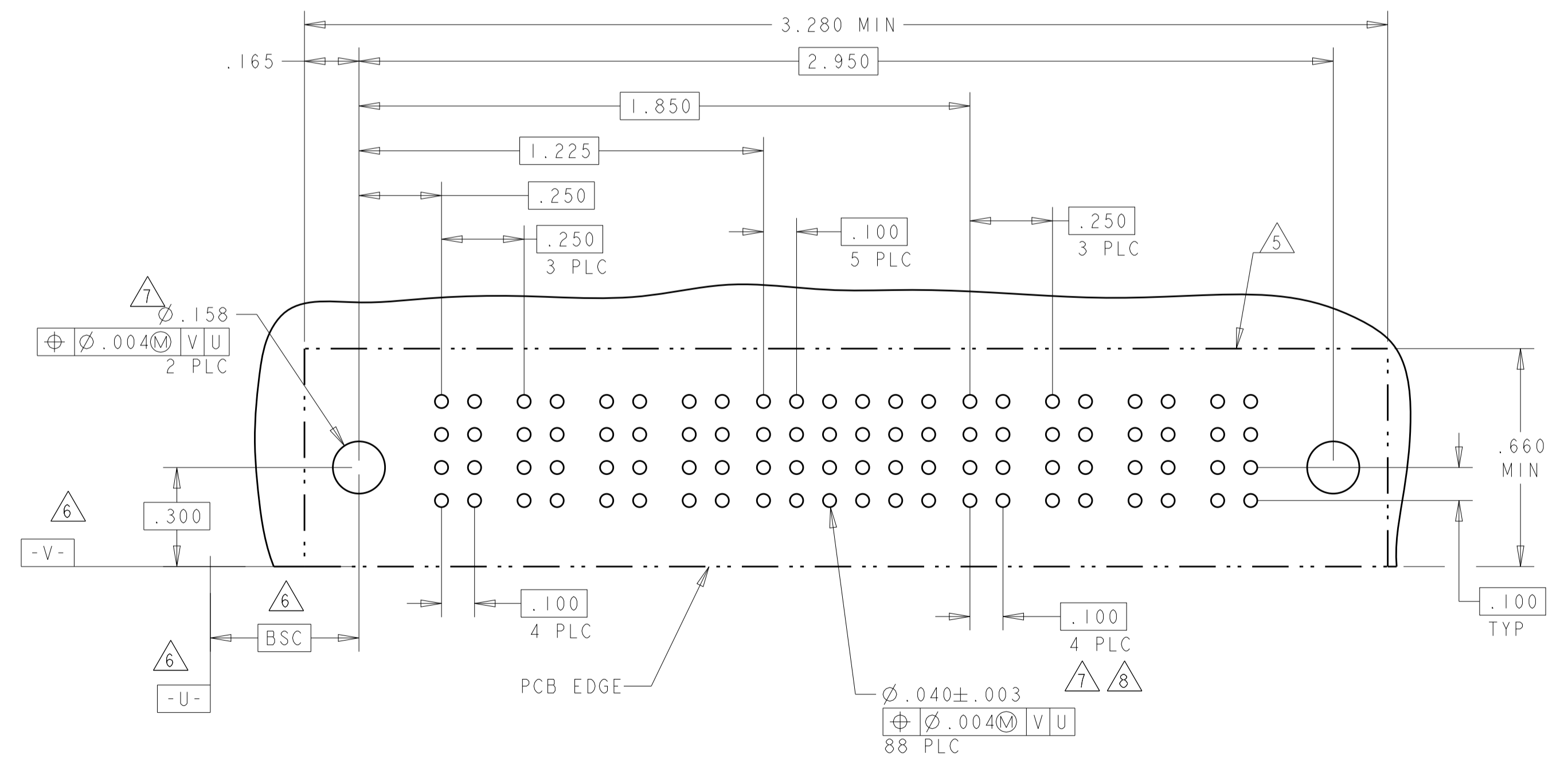

THIS DRAWING IS A CONTROLLED DOCUMENT.

DIMENSIONS: INCHES	TOLERANCES UNLESS OTHERWISE SPECIFIED:	0 PLC	±
		1 PLC	±.01
MATERIAL	FINISH	2 PLC	±.05
		3 PLC	±.0020
		4 PLC	±.0020
		ANGLES	90°

OWN: R. GRZYBOWSKI	28FEB05	NAME: M. PERCHERKE
CHK: M. PERCHERKE	28FEB05	
APVD:		PRODUCT SPEC
		APPLICATION SPEC
		108-1973
		114-13038
		WEIGHT
		CUSTOMER DRAWING

STE TE Connectivity

RIGHT ANGLE HEADER ASSEMBLY
SOLDER TAILS, W/GUIDES
MULTI-BEAM XL

SIZE: A1 00779 C=6450330
SCALE: 1:1 SHEET 10 OF 19 REV: P9

REVISONS		DATE	BY	APPR
ES	00			
DESCRIPTION	SEE SHEET 1			

PART NUMBER	ROWS	POWER			SIGNAL						POWER		
		P1	P2	P3	1	2	3	4	5	6	P4	P5	P6
5-6450330-2	D	PM	PM	PM	J	J	J	J	J	J	PM	PM	PM
	C				K	K	K	K	K	K			
	B				N	N	G	N	N	N			
	A				S	S	S	S	S	S			
3P + 24S + 3P													

PART NUMBER	ROWS	SIGNAL			
		1	2	3	4
3-6450330-1	D	E	E	E	E
	C	F	F	F	K
	B	G	G	G	G
	A	H	H	H	H
16S					

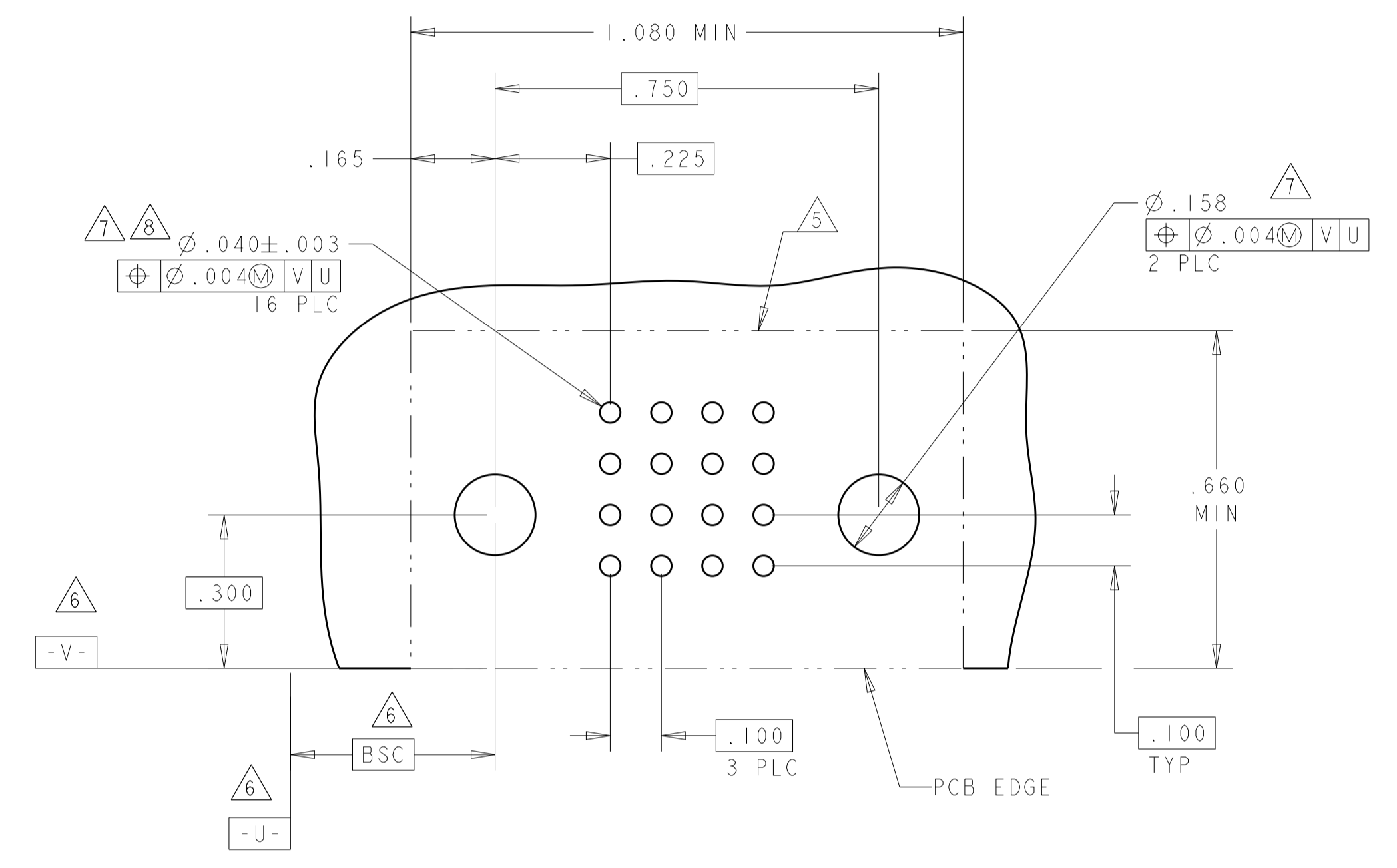
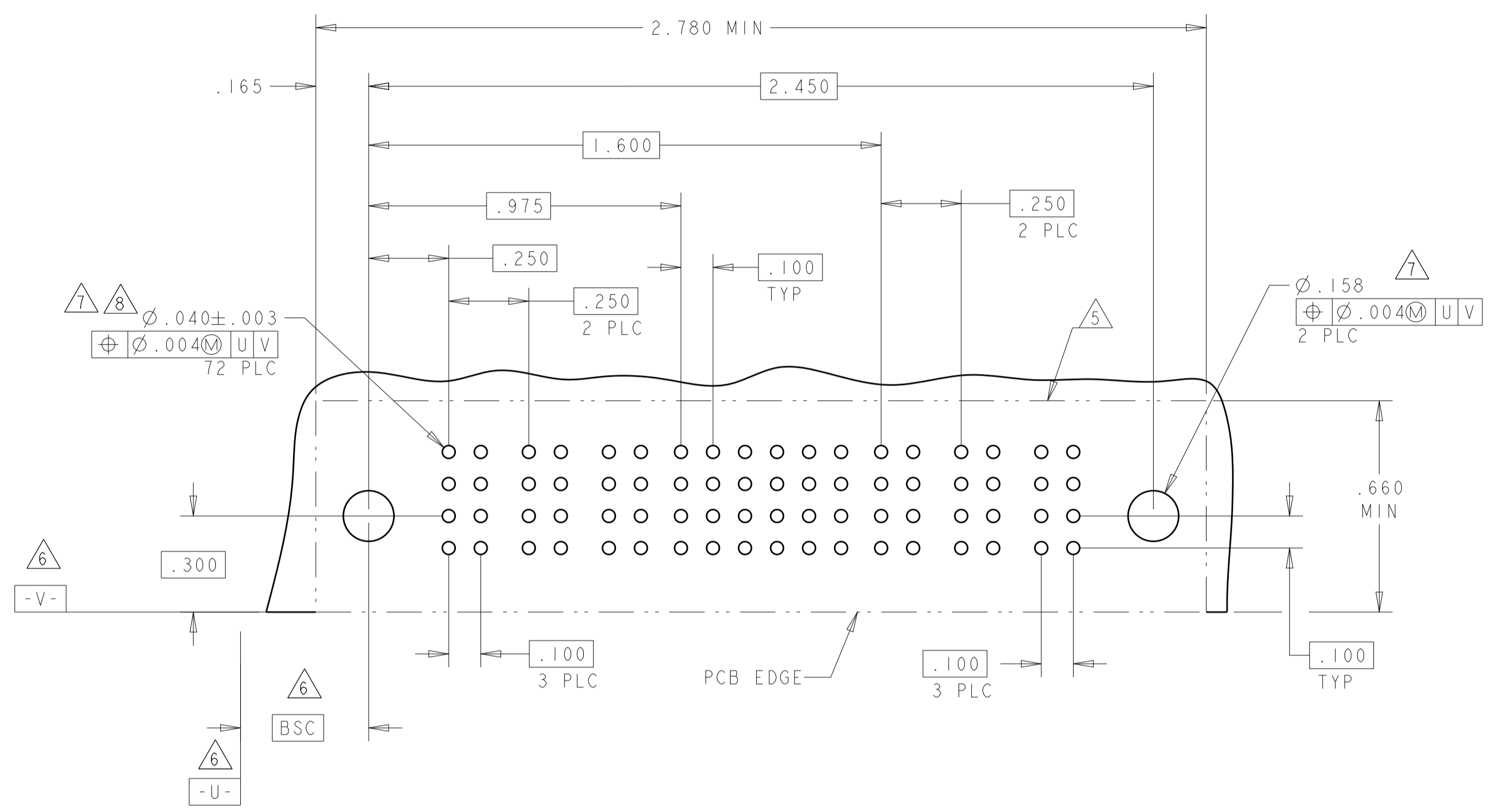

PART NUMBER	ROWS	POWER						SIGNAL		POWER							
		P1	P2	P3	P4	P5	P6	P7	1	2	P8	P9	P10	P11	P12	P13	P14
5-6450330-4	D	PM	PM	PM	PM	PM	PM	J	J	PM	PM	PM	PM	PM	PM	PM	
	C							K	K								
	B							N	N								
	A							H	S								
7P + 8S + 7P																	

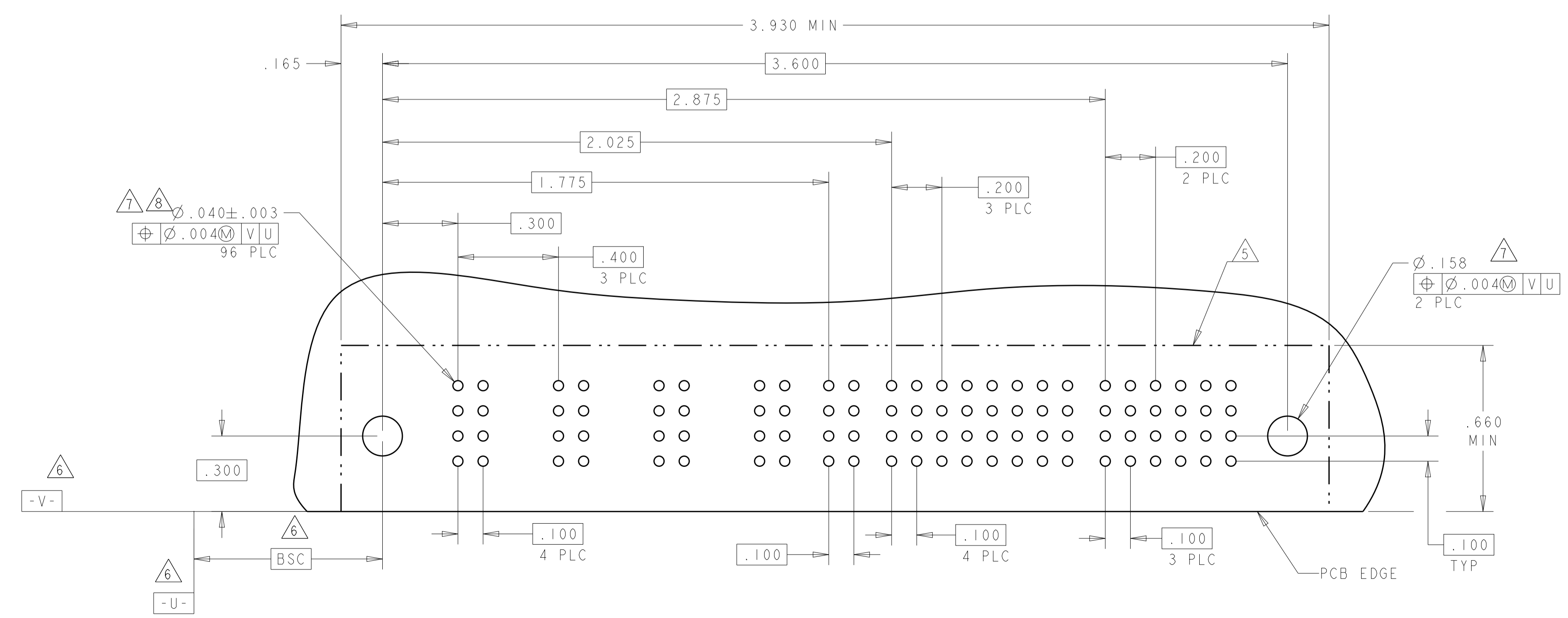

THIS DRAWING IS A CONTROLLED DOCUMENT.

OWNER: R. GRZYBOWSKI 28FEB05
 CHK: M. PERCHERKE 28FEB05
 APVD: M. PERCHERKE
 PRODUCT SPEC: 108-1973
 APPLICATION SPEC: 114-13038
 WEIGHT: -
 CUSTOMER DRAWING

DIMENSIONS: INCHES
 TOLERANCES UNLESS OTHERWISE SPECIFIED:
 0 PLC ±.
 1 PLC ±.01
 2 PLC ±.01
 3 PLC ±.005
 4 PLC ±.002
 ANGLES ±.020

MATERIAL: -
 FINISH: -

NAME: RIGHT ANGLE HEADER ASSEMBLY
 SOLDER TAILS, W/GUIDES
 MULTI-BEAM XL

SIZE: A1
 CAGE CODE: 100779
 DRAWING NO: 6450330
 SCALE: 1:1
 SHEET 11 OF 19
 REV: P.9

RESTRICTED TO: -

LOC	DIST	REVISIONS			
P	LTN	DESCRIPTION	DATE	OWN	APVD
ES	00	SEE SHEET 1			

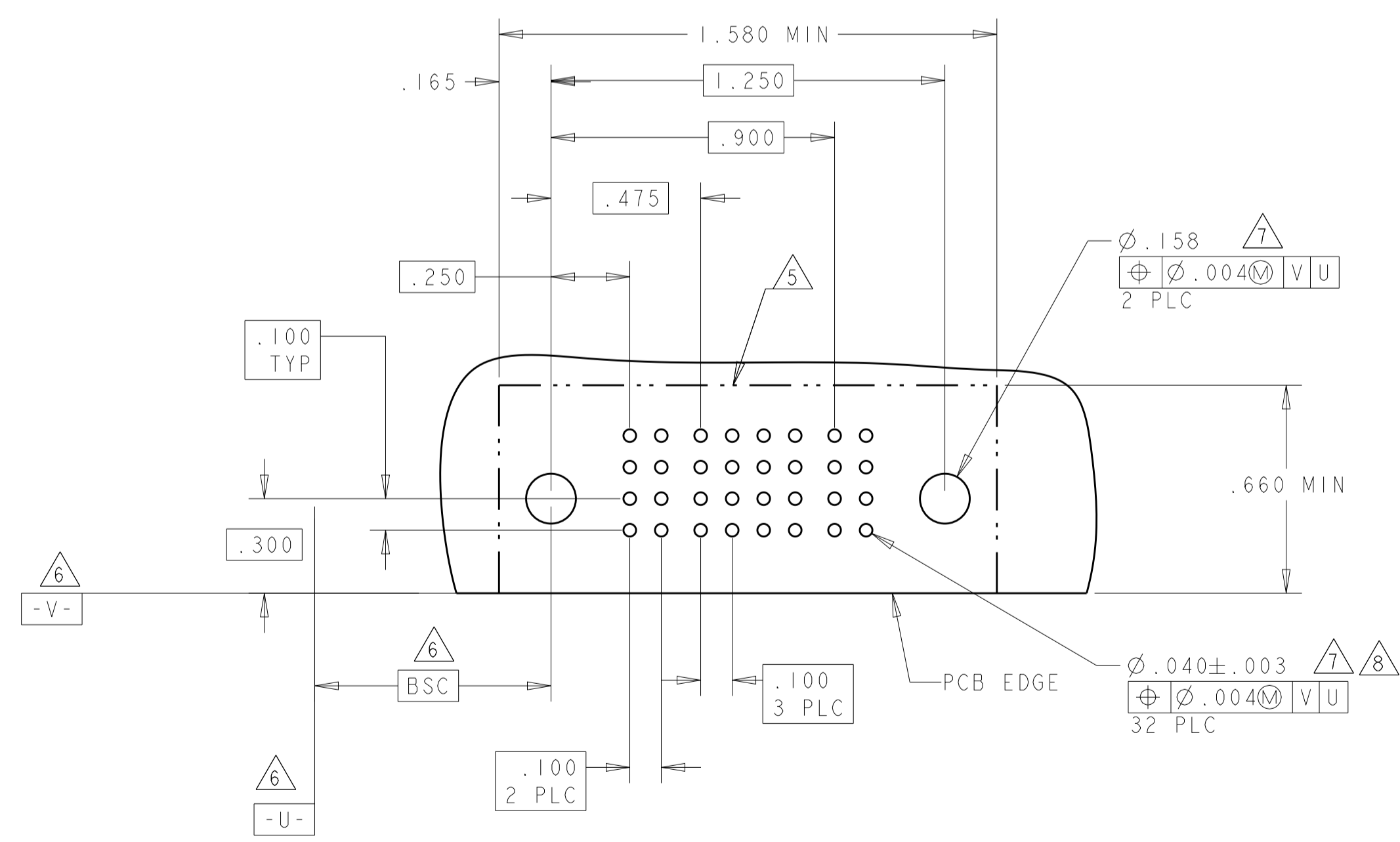
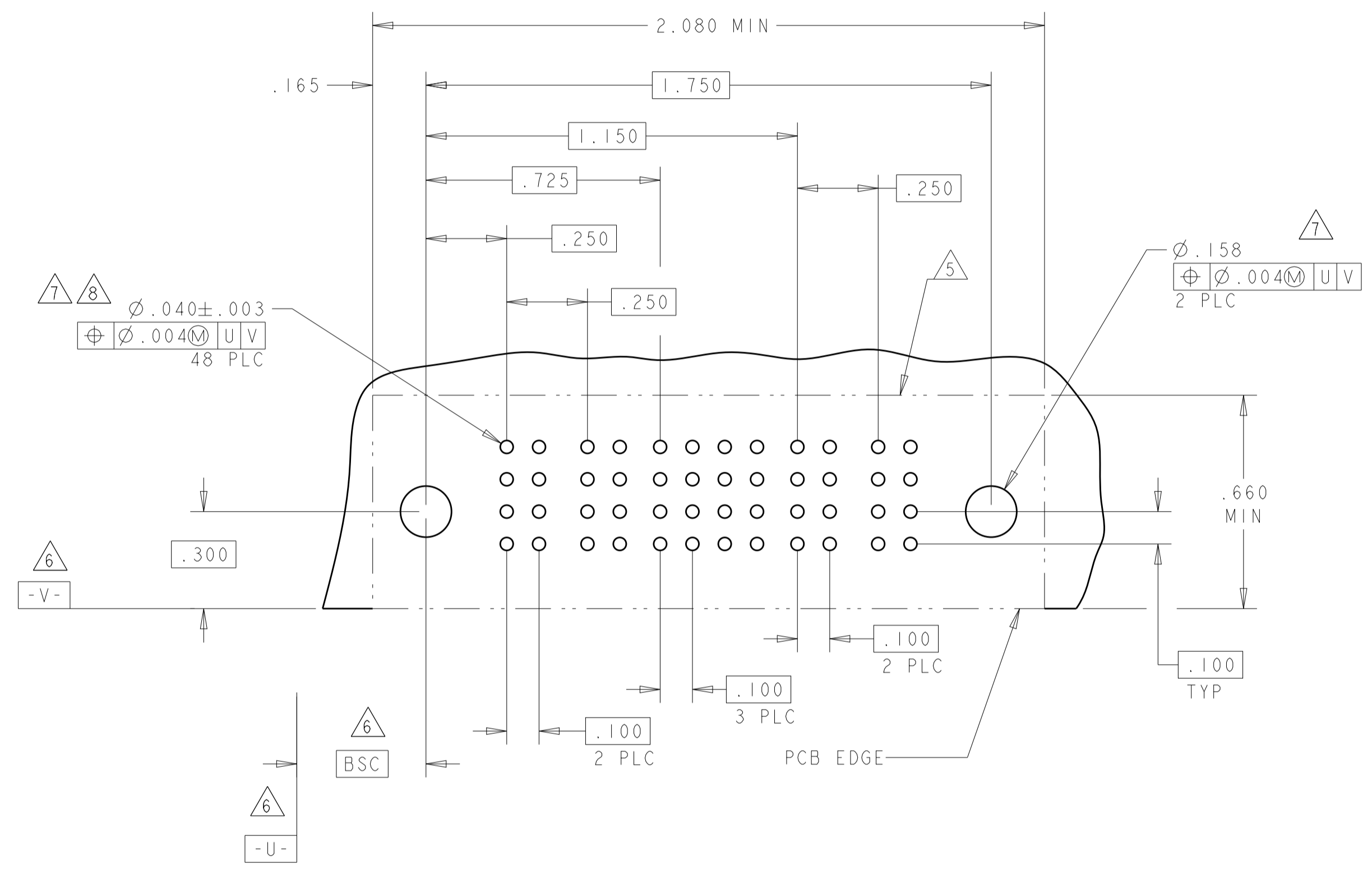
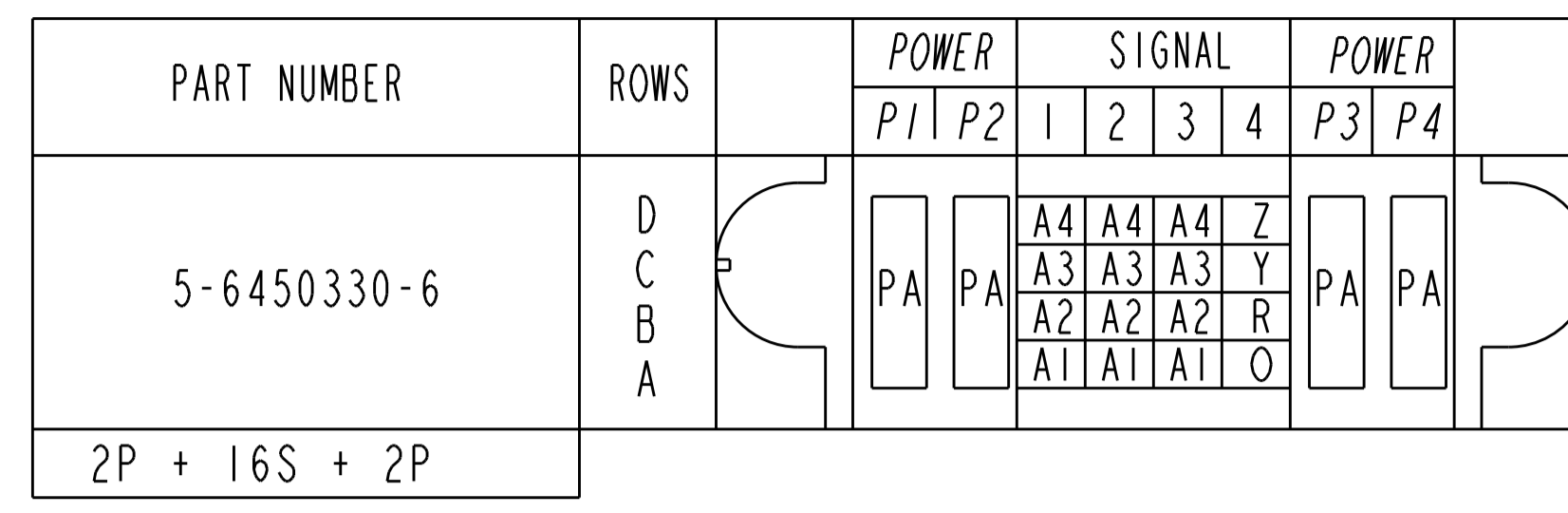
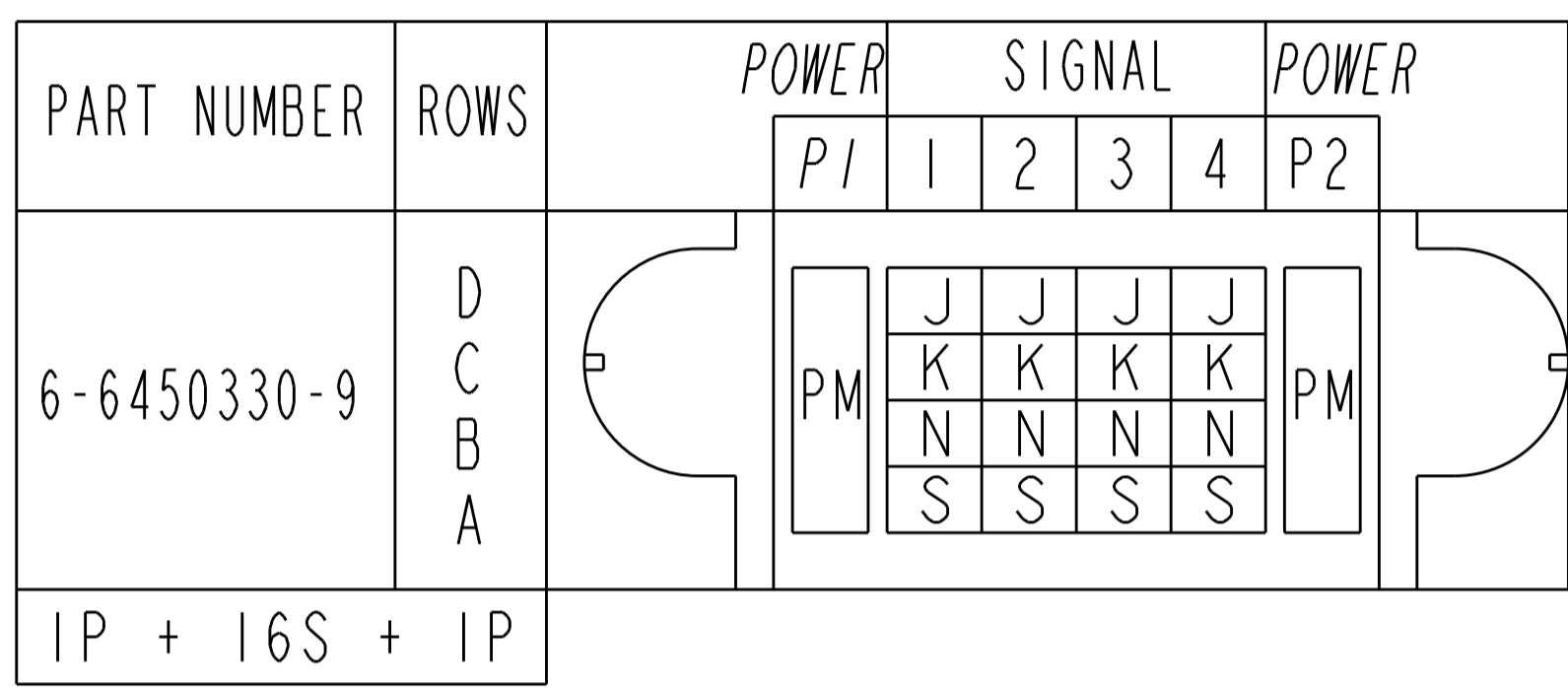
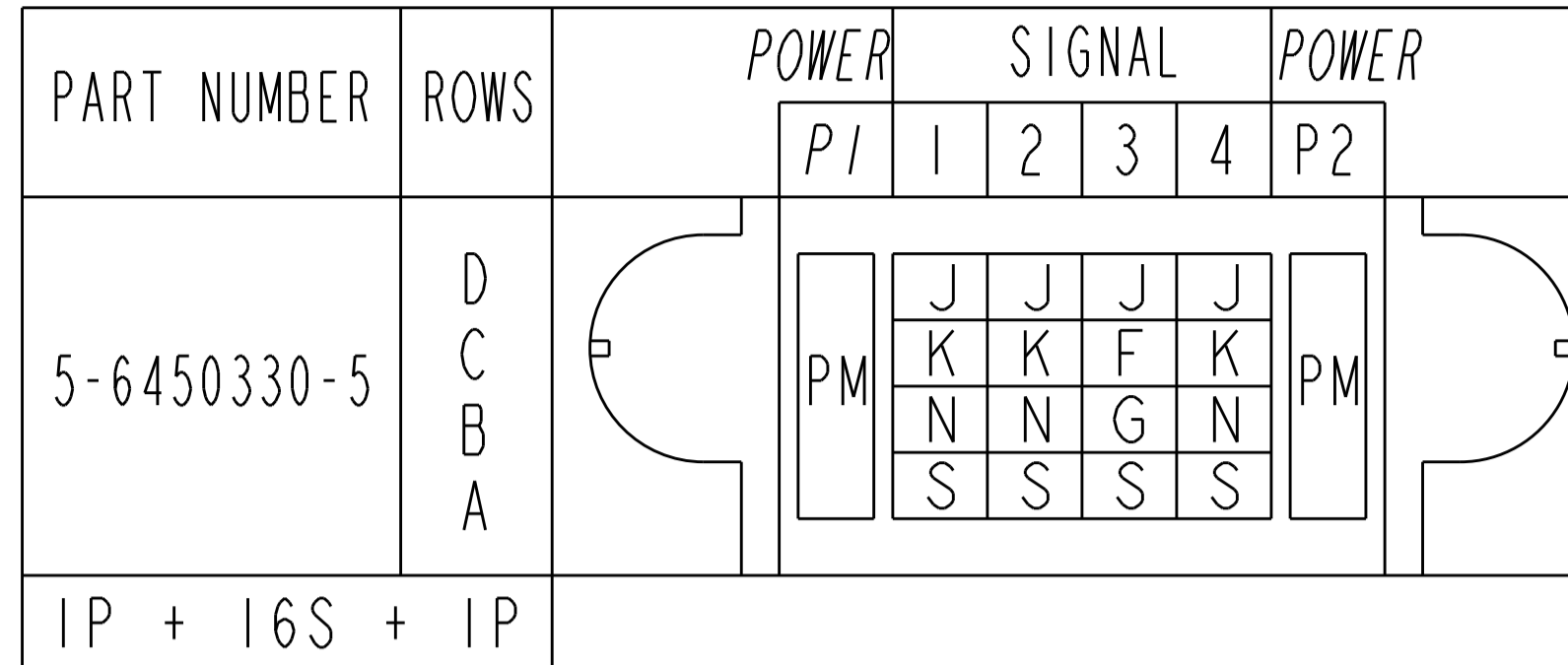

PCB LAYOUT VIEW FOR P/N: 5-6450330-5 AND 6-6450330-9

THIS DRAWING IS A CONTROLLED DOCUMENT.		OWN: R. GRZYBOWSKI 28FEB05	TE Connectivity
DIMENSIONS: INCHES		CHK: M. PERCHERKE 28FEB05	
TOLERANCES UNLESS OTHERWISE SPECIFIED:		APVD: M. PERCHERKE	NAME: RIGHT ANGLE HEADER ASSEMBLY SOLDER TAILS, W/GUIDES MULTI-BEAM XL
0 PLC ±. 1 PLC ±.01 2 PLC ±.01 3 PLC ±.005 4 PLC ±.002 ANGLES ±.020		PRODUCT SPEC: 108-1973	SIZE: A1
MATERIAL: FINISH: *		APPLICATION SPEC: 114-13038	CAGE CODE: C=6450330
		WEIGHT: -	RESTRICTED TO: -
		CUSTOMER DRAWING	SCALE: 1:1 SHEET 12 OF 19 REV: P.9

LOC	DIST	REVISIONS			
P	LTN	DESCRIPTION	DATE	DMN	APVD
ES	00	SEE SHEET 1	-	-	-

PART NUMBER	ROWS	POWER		SIGNAL												POWER	
		P1	P2	1	2	3	4	5	6	7	8	9	10	11	12	P3	P4
5-6450330-7	D	PM	PM	J	J	E	E	J	E	E	J	E	E	J	J	PM	PM
	C			F	F	K	F	F	F	K	F	F	F	F			
	B			N	N	G	G	G	G	G	N	G	G	G			
	A			H	H	S	H	H	H	S	H	H	H	H			
2P + 48S + 2P																	

PART NUMBER	ROWS	POWER						SIGNAL						POWER					
		P1	P2	P3	P4	P5	P6	1	2	3	4	5	6	P7	P8	P9	P10	P11	P12
5-6450330-8	D	PM	PM	PM	PM	PM	PM	J	J	E	E	J	J	PM	PM	PM	PM	PM	PM
	C							F	F	K	F	F	F						
	B							N	N	G	G	G	G						
	A							H	H	S	H	H	H						
6ACP + 24S + 6ACP																			

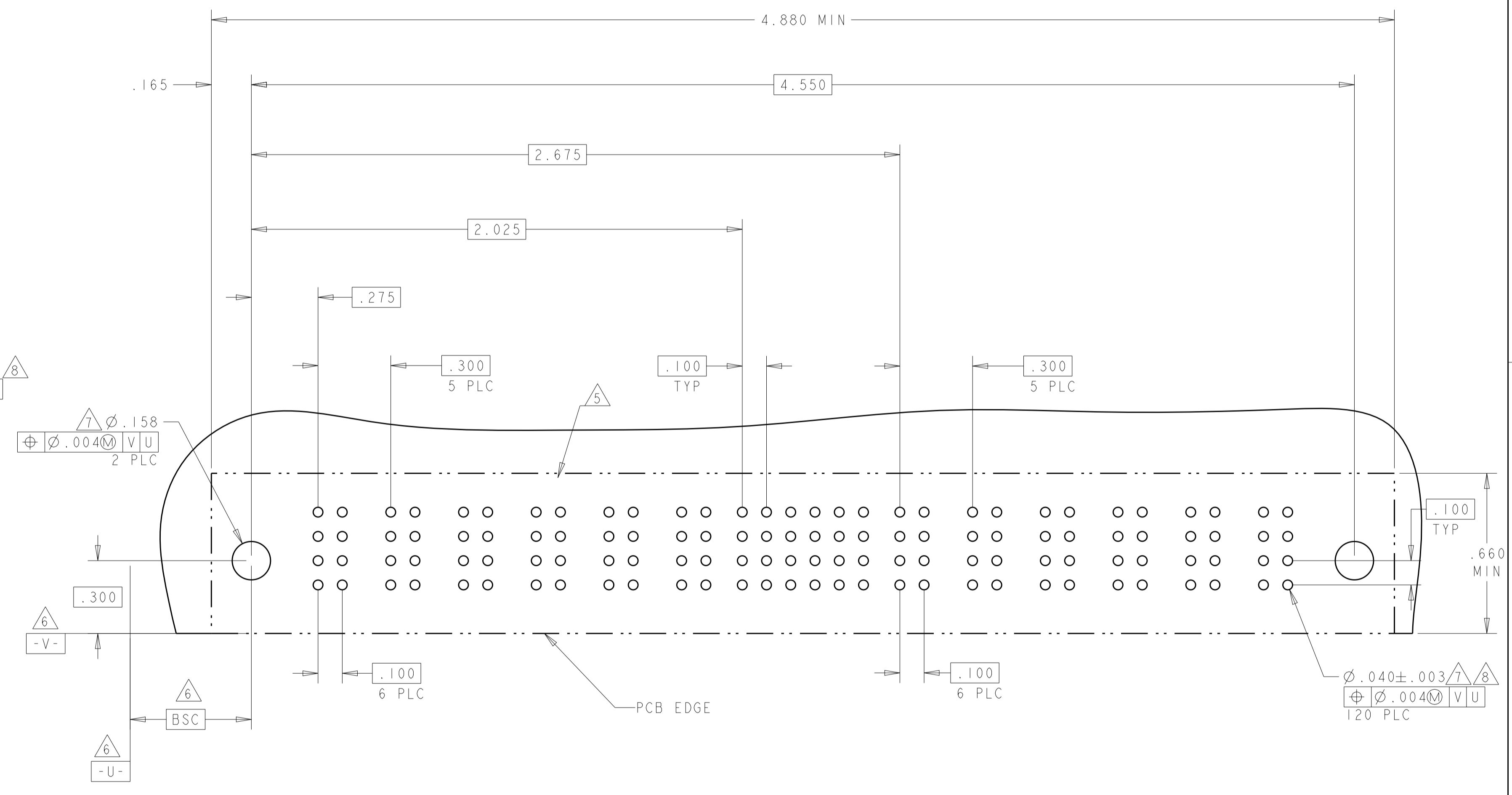
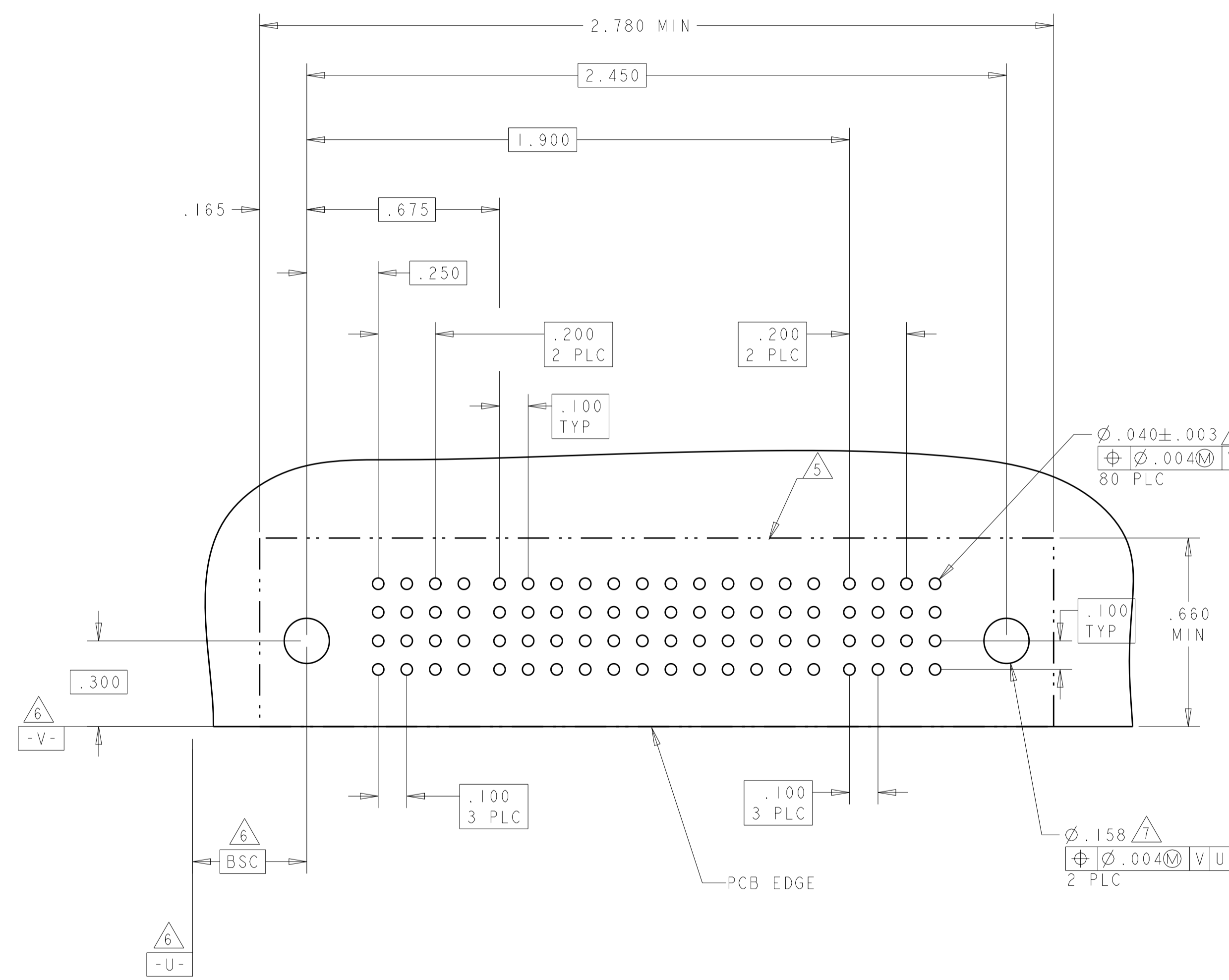

THIS DRAWING IS A CONTROLLED DOCUMENT. DWG: R.GRZYBOWSKI 28FEB05
 CHK: M.PERCHEKKE 28FEB05
 APVD: M.PERCHEKKE

STE TE Connectivity

NAME: RIGHT ANGLE HEADER ASSEMBLY
 SOLDER TAILS, W/GUIDES
 MULTI-BEAM XL

PRODUCT SPEC: 108-1973
 APPLICATION SPEC: 114-13038
 WEIGHT: -
 CUSTOMER DRAWING

DIMENSIONS: INCHES
 TOLERANCES UNLESS OTHERWISE SPECIFIED:
 0 PLC ±.
 1 PLC ±.01
 2 PLC ±.01
 3 PLC ±.005
 4 PLC ±.0020
 ANGLES ±.7°
 FINISH

SCALE: 1:1 SHEET 13 OF 19 REV P.9

LOC	DIST	REV	DATE	BY	APPV
ES	00				
		DESCRIPTION		DATE	BY
		SEE SHEET 1			

PART NUMBER	ROWS	POWER				SIGNAL						POWER			
		P1	P2	P3	P4	1	2	3	4	5	6	P5	P6	P7	P8
3-6450330-7	D	PM	PM	PM	PM	J	J	J	J	J	J	PM	PM	PM	PM
	C					K	K	K	K	K	K				
	B					N	N	N	N	N	N				
	A					H	S	S	S	S	S				
4P + 24S + 4P															

PART NUMBER	ROWS	POWER						SIGNAL		POWER	
		P1	P2	P3	P4	P5	P6	1	2	P7	P8
5-6450330-9	D	PM	PM	PM	PM	PM	PM	J	J	PM	PM
	C							K	K		
	B							N	N		
	A							FS	S		
6P + 8S + 2P											

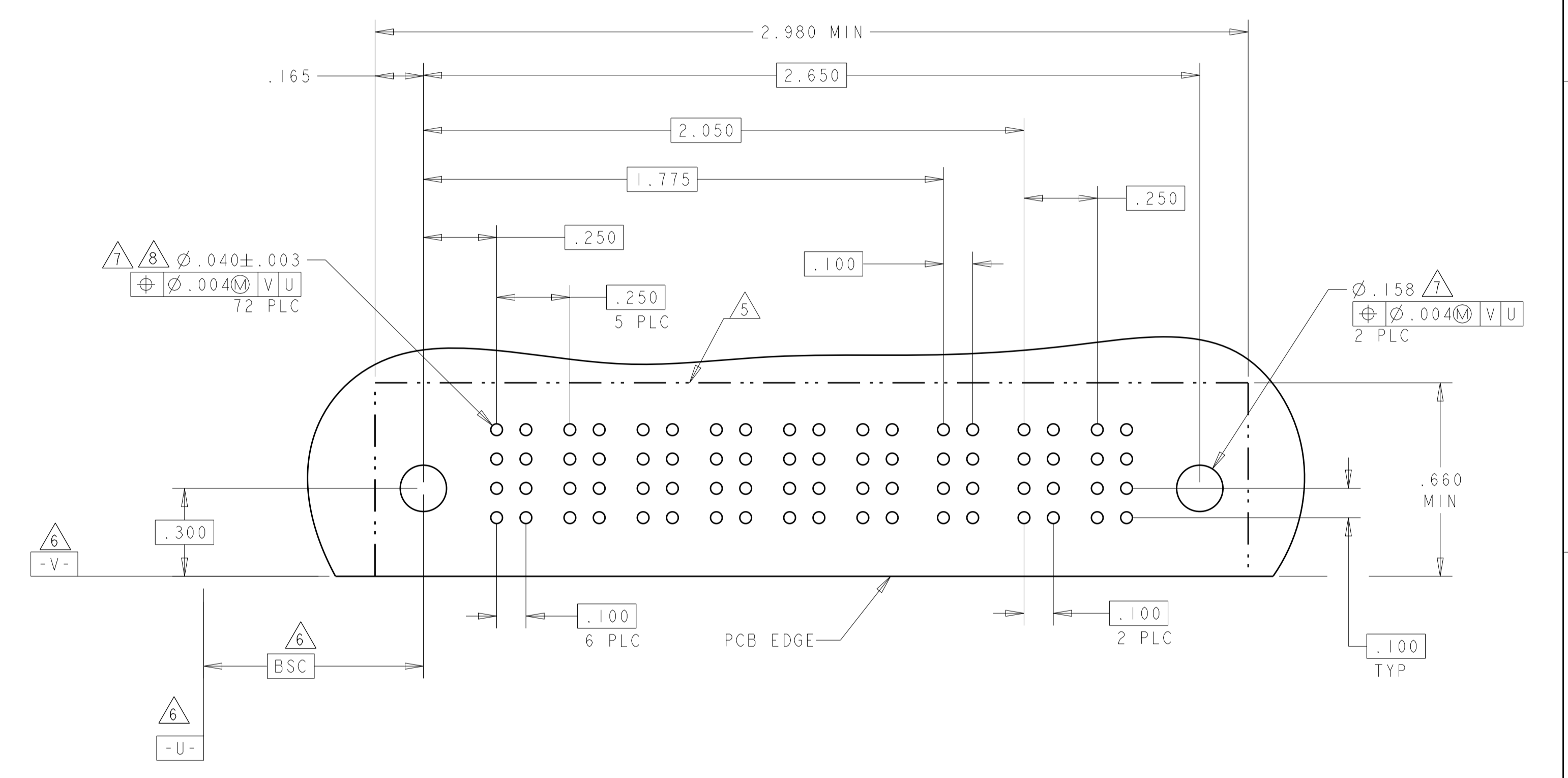
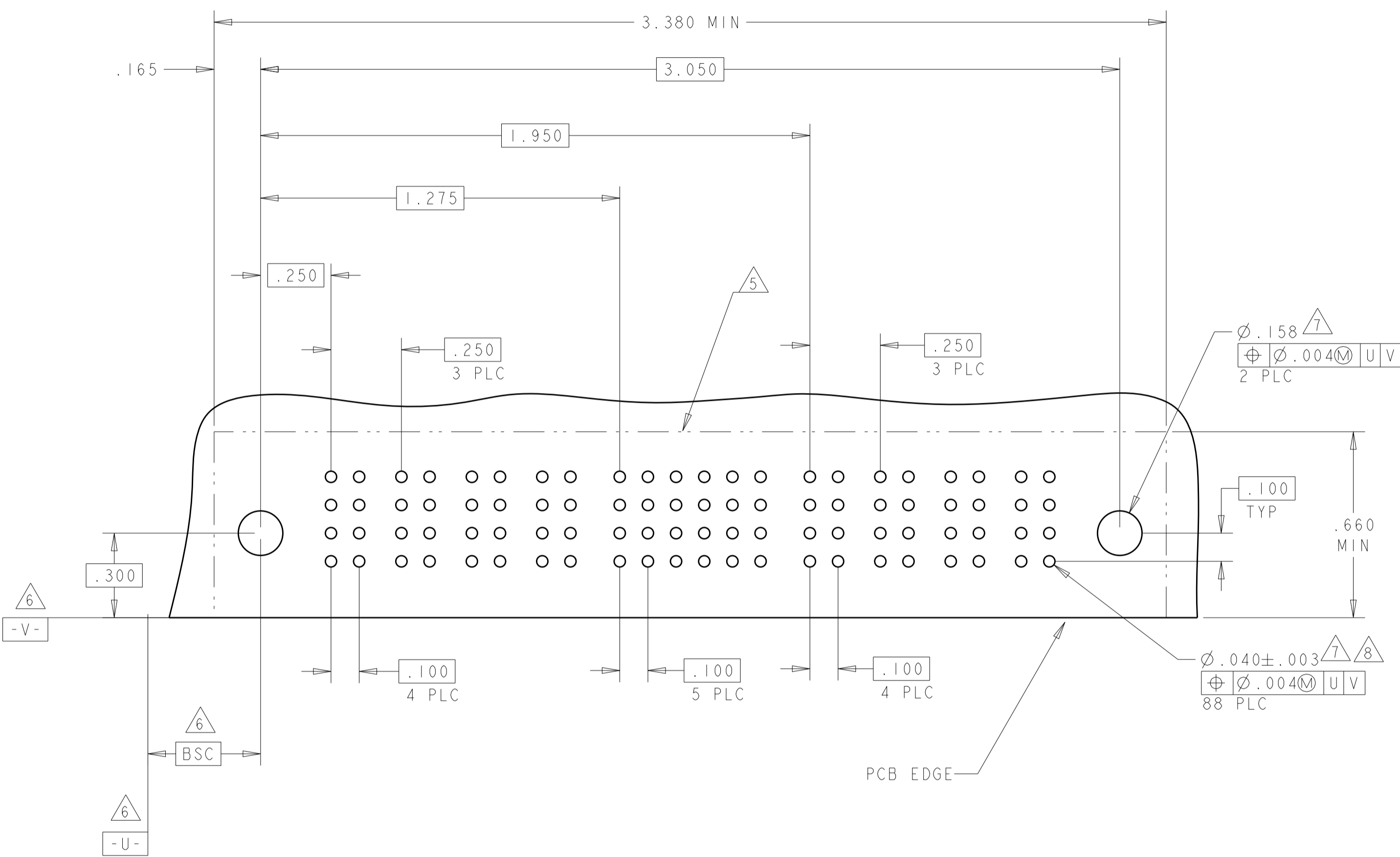

THIS DRAWING IS A CONTROLLED DOCUMENT.

DIMENSIONS:	TOLERANCES UNLESS OTHERWISE SPECIFIED:	OWN: R. GRZYBOWSKI 28FEB05	NAME: M. PERCHERKE
INCHES	0 PLC ±.010	CHK: M. PERCHERKE 28FEB05	PRODUCT SPEC: 108-1973
	1 PLC ±.010	APVD: M. PERCHERKE	APPLICATION SPEC: 114-13038
	2 PLC ±.010		WEIGHT: -
	3 PLC ±.010		SIZE: A1
	4 PLC ±.010		CAGE CODE: 6450330
	ANGLES ±.0020		SCALE: 1:1
MATERIAL:	FINISH:	CUSTOMER DRAWING	SHEET 14 OF 19

STE TE Connectivity
 RIGHT ANGLE HEADER ASSEMBLY
 SOLDER TAILS, W/GUIDES
 MULTI-BEAM XL

LOC	DIST	REVISIONS			
P	LTN	DESCRIPTION	DATE	DMN	APVD
-	-	SEE SHEET 1	-	-	-

PART NUMBER	ROWS	POWER												SIGNAL												POWER										
		P1	P2	P3	P4	P5	P6	P7	P8	P9	P10	P11	P12	1	2	3	4	5	6	7	8	9	10	11	12	P13	P14	P15	P16	P17	P18	P19	P20			
6-6450330-0	D C B A	PM		PM		PM		PM		PM		PM		J	J	J									E	E	E	PM	PM		PM	PM				
														K	K	K									F	F	F									
														N	N	N										G	G	G								
														S	S	H										H	S	S								
12P + 48S + 8P																																				

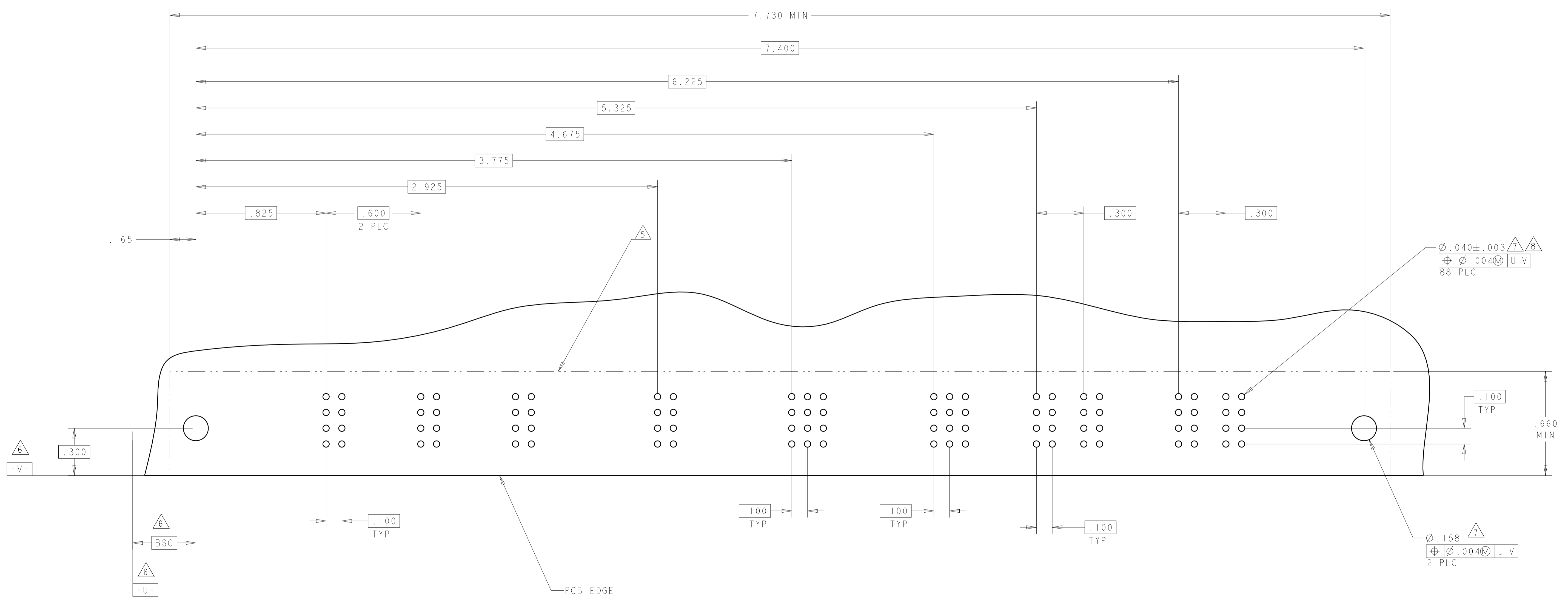

THIS DRAWING IS A CONTROLLED DOCUMENT.

DIMENSIONS: INCHES	TOLERANCES UNLESS OTHERWISE SPECIFIED: 0 PLC ±. 1 PLC ±. 2 PLC ±.01 3 PLC ±.005 4 PLC ±.0020 ANGLES ±.2°	FINISH	APVD: M. PERCHERKE	NAME: M. PERCHERKE	PRODUCT SPEC: 108-1973	APPLICATION SPEC: 114-13038	WEIGHT: -	SCALE: 1:1
-----------------------	--	--------	--------------------	--------------------	------------------------	-----------------------------	-----------	------------

DWN: R. GRZYBOWSKI 28FEB05
 CHK: M. PERCHERKE 28FEB05
 APVD: M. PERCHERKE
 NAME: M. PERCHERKE
 PRODUCT SPEC: 108-1973
 APPLICATION SPEC: 114-13038
 WEIGHT: -
 SCALE: 1:1
 SHEET 15 OF 19
 REV P.9

STE TE Connectivity
 RIGHT ANGLE HEADER ASSEMBLY
 SOLDER TAILS, W/GUIDES
 MULTI-BEAM XL
 SIZE: A100779 C=6450330
 CUSTOMER DRAWING

LOC	DIST	REVISIONS			
P	LTN	DESCRIPTION	DATE	DMN	APVD
-	-	SEE SHEET 1	-	-	-

PART NUMBER	ROWS	POWER		SIGNAL						POWER			
		P1	P2	1	2	3	4	5	6	P3	P4	P5	P6
3-6450330-5	D	PM	PM	J	J	J	E	J	J	PM	PM	PM	PM
	C			K	K	K	K	K					
	B			N	N	N	G	N	N				
	A			S	S	S	S	S	S				
2P + 24S + 4P													

(N6)

PART NUMBER	ROWS	POWER			SIGNAL				POWER			
		P1	P2	P3	1	2	3	4	P4	P5	P6	
6-6450330-1	D	PM	PM	PM	J	J	J	J	PM	PM	PM	
	C				K	K	K	F				
	B				G	N	N	N				
	A				S	S	S	S				
3P + 16S + 3P												

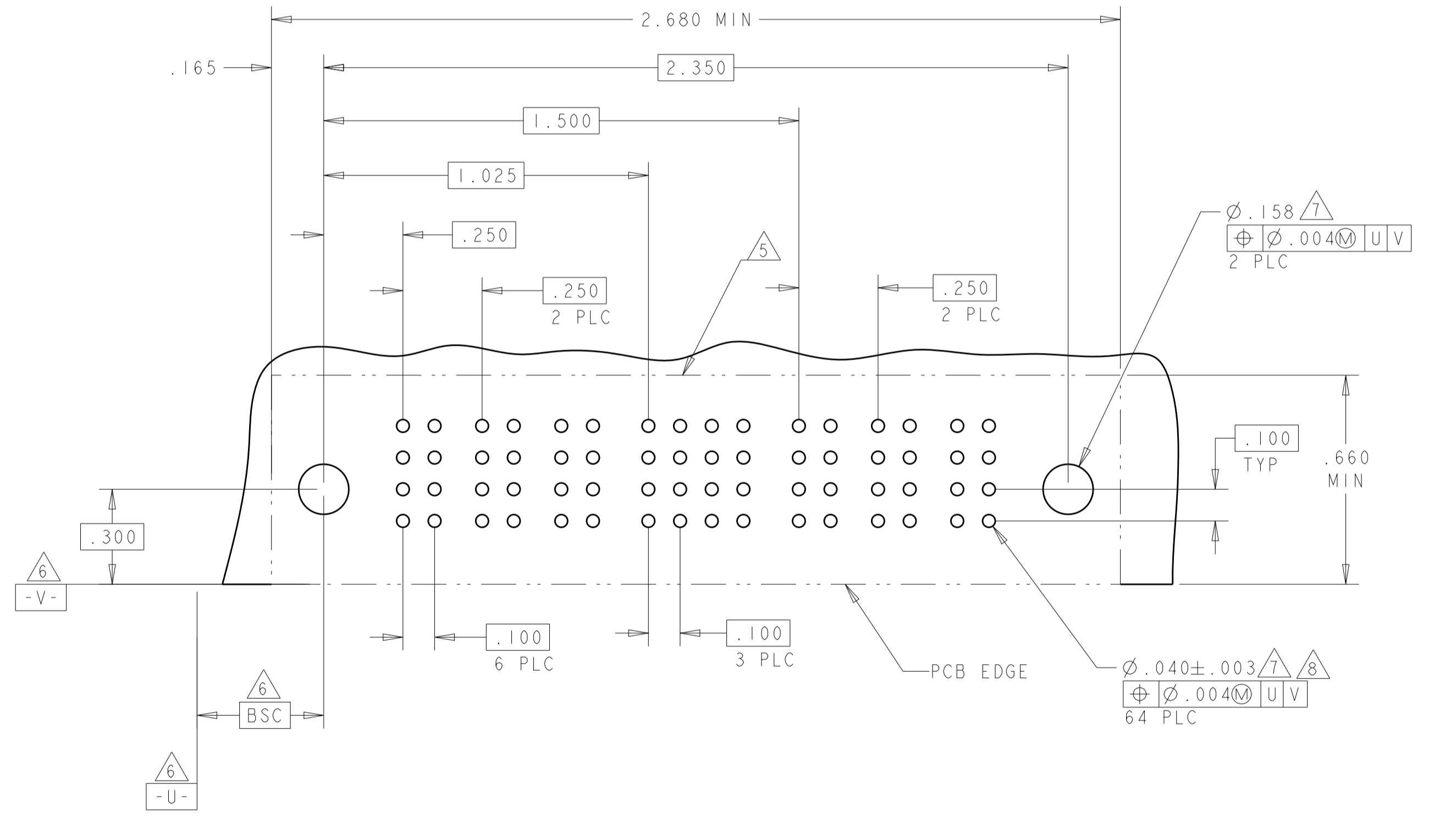
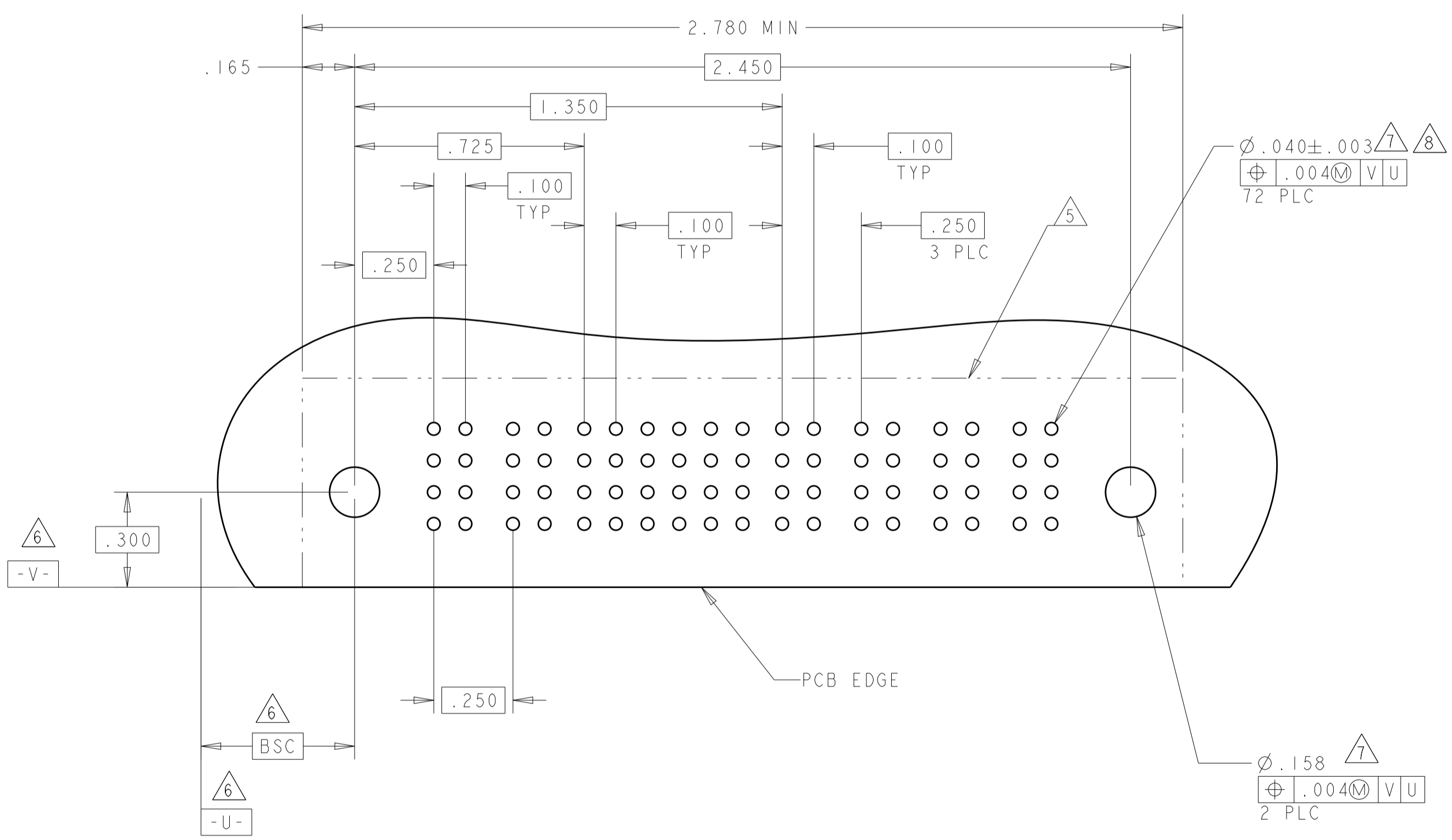

THIS DRAWING IS A CONTROLLED DOCUMENT.

DIMENSIONS: INCHES	TOLERANCES UNLESS OTHERWISE SPECIFIED: 0 PLC ±. 1 PLC ±.01 2 PLC ±.01 3 PLC ±.005 4 PLC ±.0020 ANGLES ±.7°	FINISH	OWN: R. GRZYBOWSKI 28FEB05 CHK: M. PERCHERKE 28FEB05 APVD: M. PERCHERKE NAME: M. PERCHERKE PRODUCT SPEC: 108-1973 APPLICATION SPEC: 114-13038 WEIGHT: -	TE Connectivity RIGHT ANGLE HEADER ASSEMBLY SOLDER TAILS, W/GUIDES MULTI-BEAM XL
MATERIAL			SIZE: 114-13038 CAGE CODE: - DRAWING NO: A100779 CUSTOMER DRAWING	RESTRICTED TO: - SCALE: 1:1 SHEET: 16 OF 19 REV: P.9

LOC		DIST		REVISIONS			
ES	00	P	LTN	DESCRIPTION	DATE	DMN	APVD
		-		SEE SHEET 1			

PART NUMBER	ROWS	POWER		SIGNAL				POWER	
		P1	P2	1	2	3	4	P3	P4
6-6450330-3	D	PM	PM	J	J	J	J	PM	PM
	C			K	K	K	K		
	B			N	N	N	N		
	A			S	S	S	S		
IP + 16S + IP									

PART NUMBER	ROWS	POWER		SIGNAL		POWER	
		P1	P2	1	2	P3	P4
6-6450330-4	D	PM	PM	J	J	PM	PM
	C			K	K		
	B			N	N		
	A			FS	S		
2P + 8S + 2P							

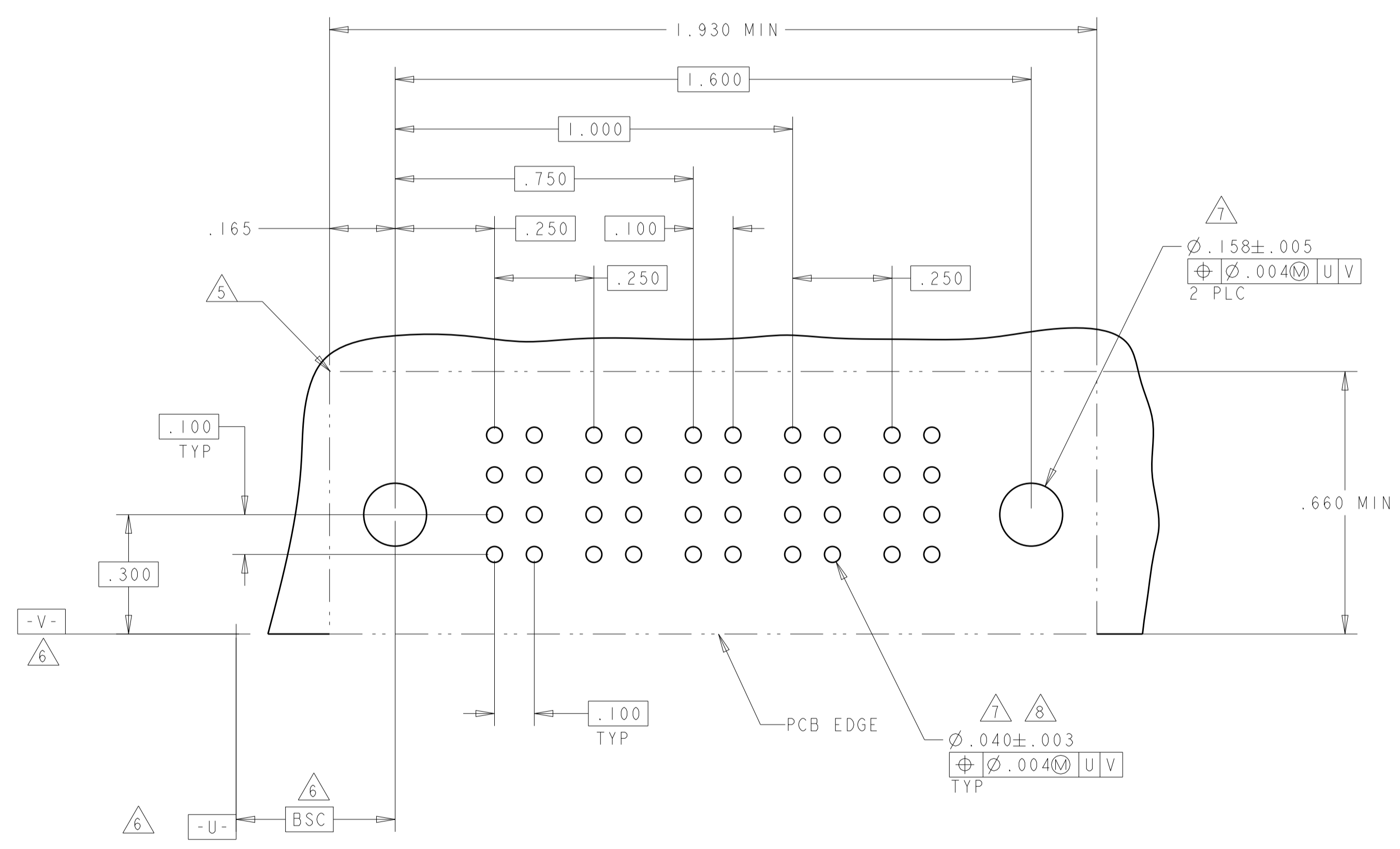
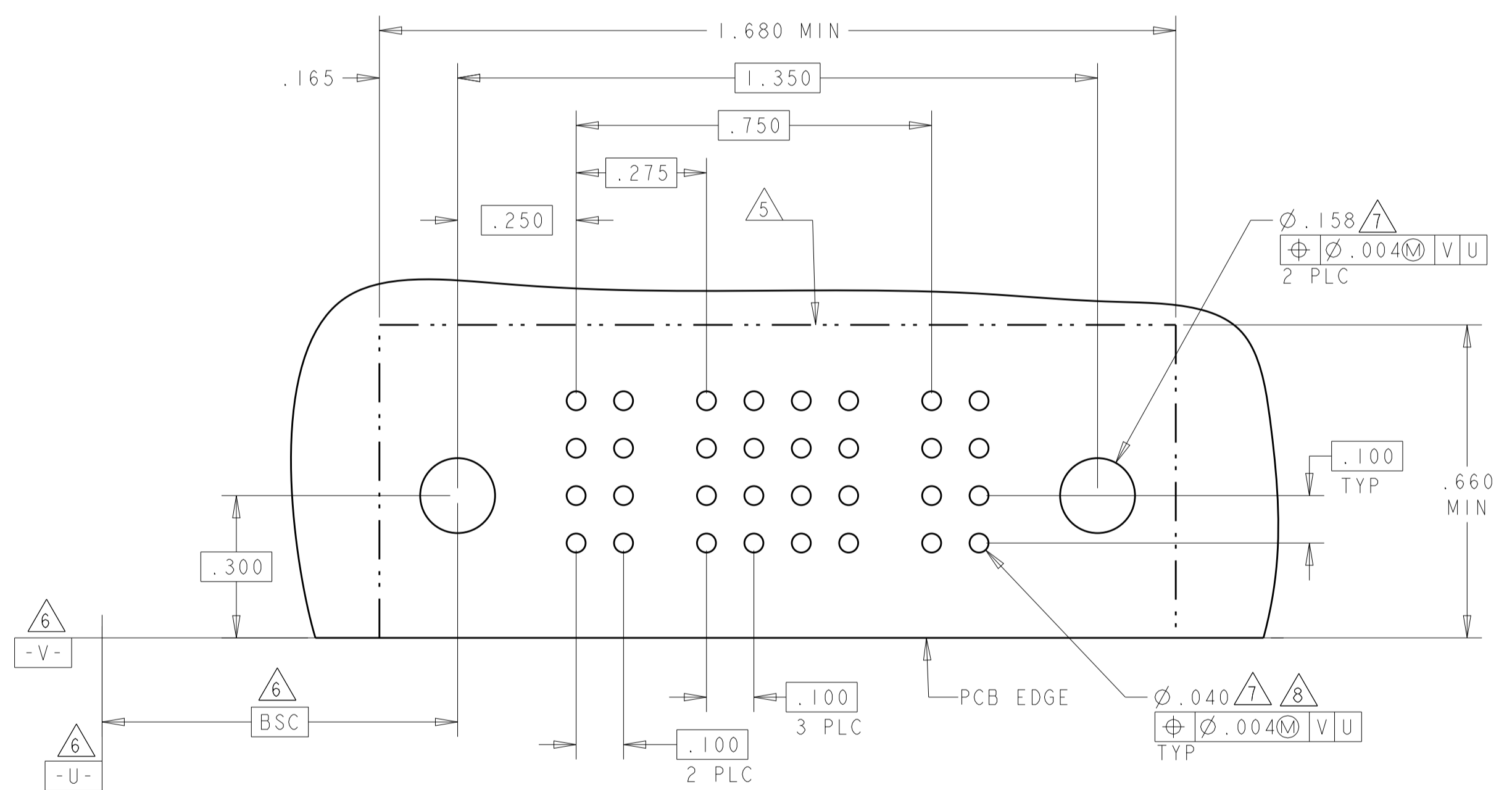

THIS DRAWING IS A CONTROLLED DOCUMENT.

DIMENSIONS:	TOLERANCES UNLESS OTHERWISE SPECIFIED:	OWN: R. GRZYBOWSKI 28FEB05	CHK: M. PERCHERKE 28FEB05	APVD: M. PERCHERKE	NAME: M. PERCHERKE
INCHES	0 PLC ±.01 1 PLC ±.01 2 PLC ±.01 3 PLC ±.005 4 PLC ±.002 ANGLES ±.2°	PRODUCT SPEC: 108-1973	APPLICATION SPEC: 114-13038	WEIGHT: -	SIZE: A1
MATERIAL:	FINISH:	CAGE CODE: -	DRAWING NO: 6450330	SCALE: 1:1	SHEET 17 OF 19
CUSTOMER DRAWING		REV: P.9		RESTRICTED TO: -	

RIGHT ANGLE HEADER ASSEMBLY
 SOLDER TAILS, W/GUIDES
 MULTI-BEAM XL

TE Connectivity

LOC		DIST		REVISIONS				
ES	00	P	LTN	DESCRIPTION	DATE	DMN	APVD	
-	-	-	-	SEE SHEET 1	-	-	-	

PART NUMBER	ROWS	POWER		SIGNAL										POWER			
		P1	P2	1	2	3	4	5	6	7	8	9	10	P1	P2		
6-6450330-5	D C B A	PM	PM	J	J	J	J	J	J	J	J	J	J	J	J	PM	PM
				K	K	K	F	K	K	K	K	K	K	K	K		
				N	N	N	N	N	N	N	N	N	N	N	N		
IP + 40S + IP				S	S	S	S	S	S	S	S	S	S	S	S	S	S

PART NUMBER	ROWS	POWER		SIGNAL						POWER			
		P1	P2	1	2	3	4	5	6	P1	P2		
6-6450330-6	D C B A	PM	PM	J	J	J	J	J	J	J	J	PM	PM
				K	K	K	K	K	K	K	K		
				N	N	N	N	G	N	N	N		
IP + 24S + IP				S	S	S	S	S	S	S	S	S	S

NO CONTACTS LOADED

PART NUMBER	ROWS	POWER		SIGNAL						POWER			
		P1	P2	1	2	3	4	5	6	P1	P2		
6-6450330-7	D C B A	PM	PM	J	J	J	J	J	J	J	J	PM	PM
				K	K	K	K	K	K	K	K		
				N	N	N	N	G	N	N	N		
IP + 24S + IP				S	S	S	S	S	S	S	S	S	S

NO CONTACTS LOADED

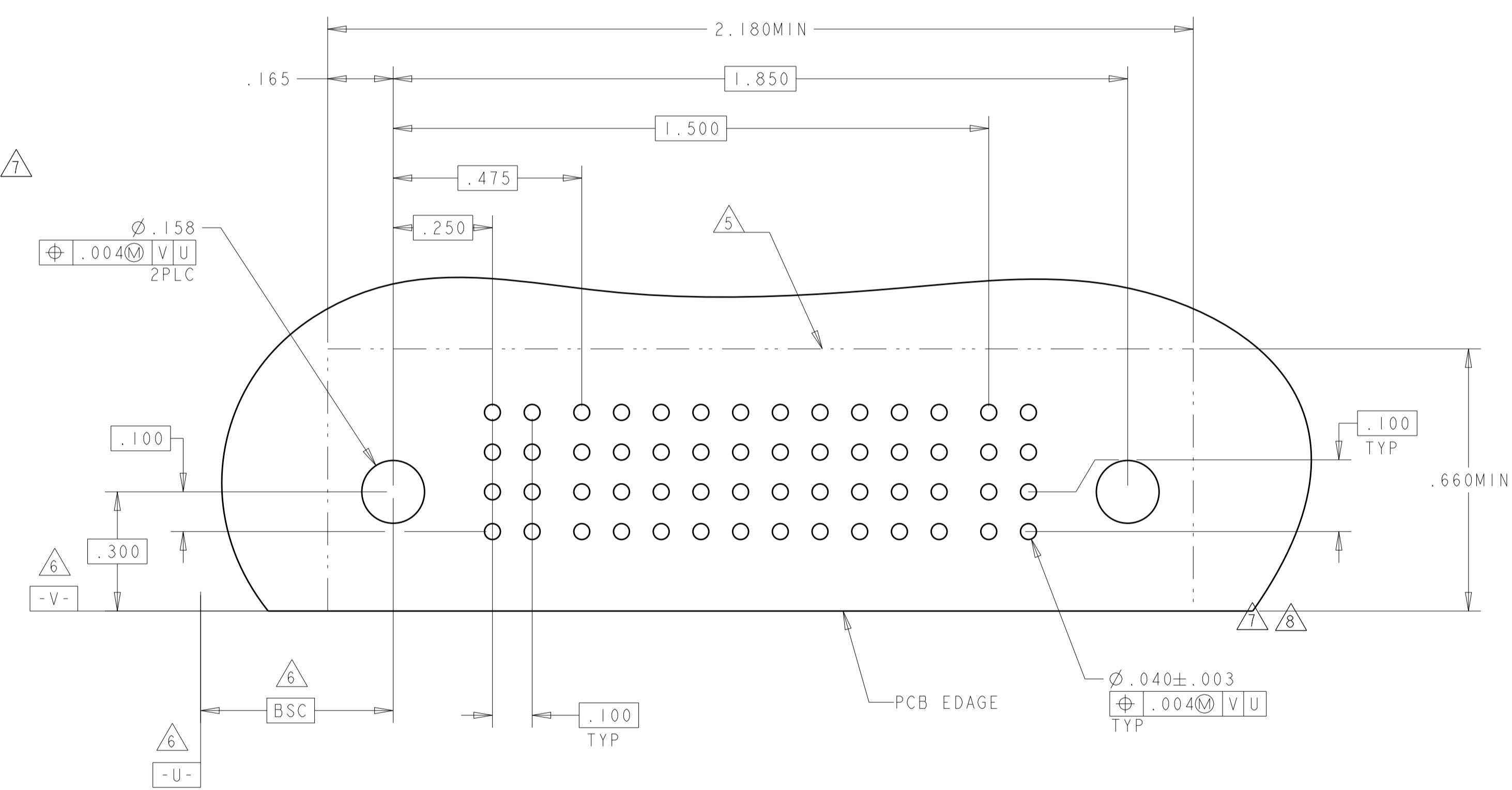

TE RECOMMENDED PCB LAYOUT

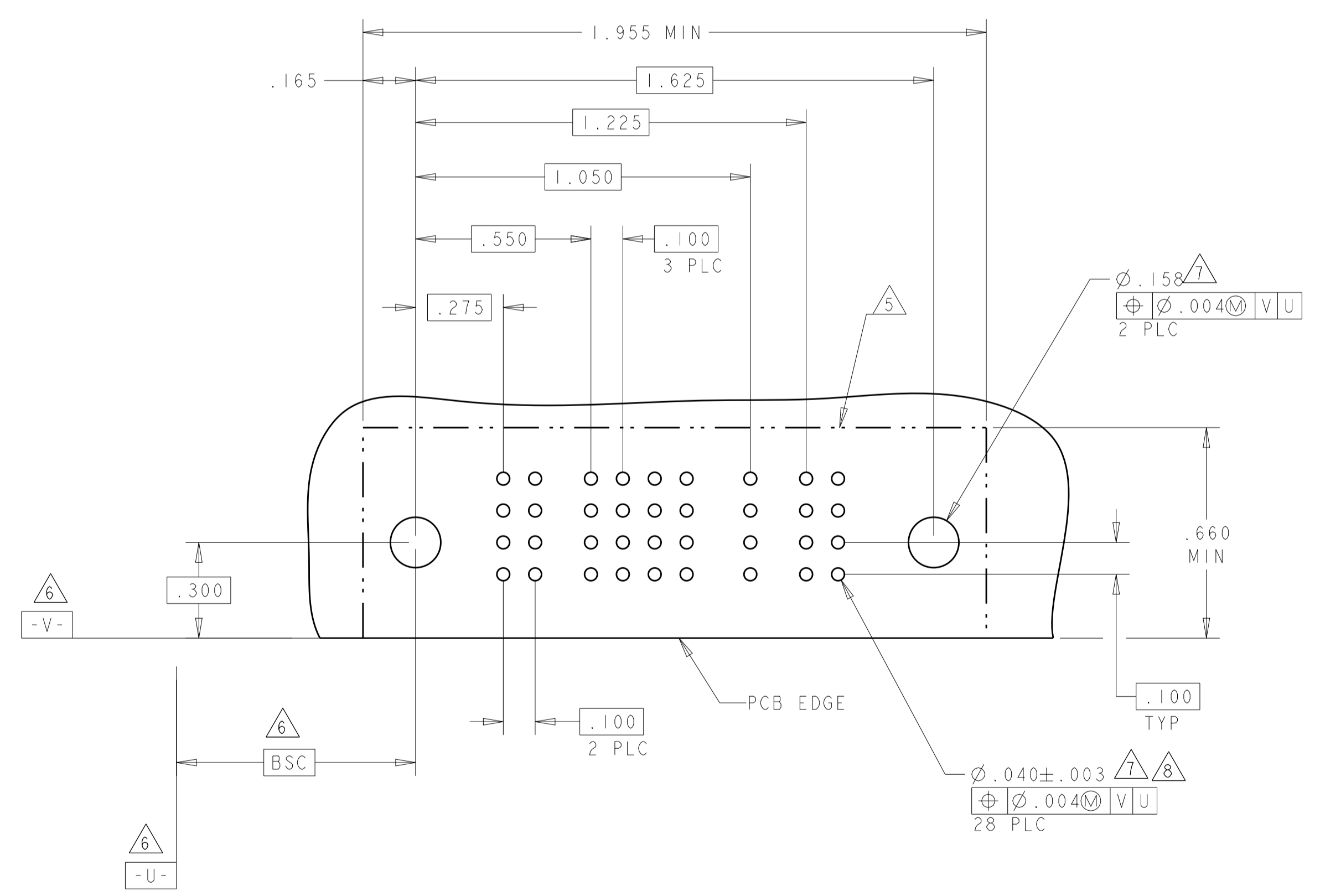

6-6450330-6 AND 6-6450330-7 PCB LAYOUT

THIS DRAWING IS A CONTROLLED DOCUMENT.		DMN R. GRZYBOWSKI 28FEB05	28FEB05	TE Connectivity
DIMENSIONS: INCHES		CHK M. PERCHERKE 28FEB05	28FEB05	
TOLERANCES UNLESS OTHERWISE SPECIFIED:		APVD M. PERCHERKE	NAME	RIGHT ANGLE HEADER ASSEMBLY SOLDER TAILS, W/GUIDES MULTI-BEAM XL
0 PLC ±. 2 PLC ±.01 3 PLC ±.005 4 PLC ±.0020 ANGLES ±.7°		PRODUCT SPEC 108-1973	APPLICATION SPEC 114-13038	
MATERIAL		FINISH	WEIGHT	RESTRICTED TO
CUSTOMER DRAWING		SCALE 1:1	SHEET 18	OF 19
		REV P.9		

LOC	DIST	REVISIONS					
		P	LTN	DESCRIPTION	DATE	DMN	APVD
ES	00	-	-	SEE SHEET 1	-	-	-

PART NUMBER	ROWS	POWER					SIGNAL								POWER					
		P1	P2	P3	P4	P5	1	2	3	4	5	6	7	8	P6	P7	P8	P9	P10	P11
6-6450330-8	D	PM	PM	PM	PM	PM	J	J	J	J	J	J	J	J	PM	PM	PM	PM	PM	PM
	C						K	K	F	K	K	K	K							
	B						N	N	N	N	N	N	N							
	A						S	S	S	S	S	S	S							

5ACP + 32S + 6P

NO CONTACTS LOADED

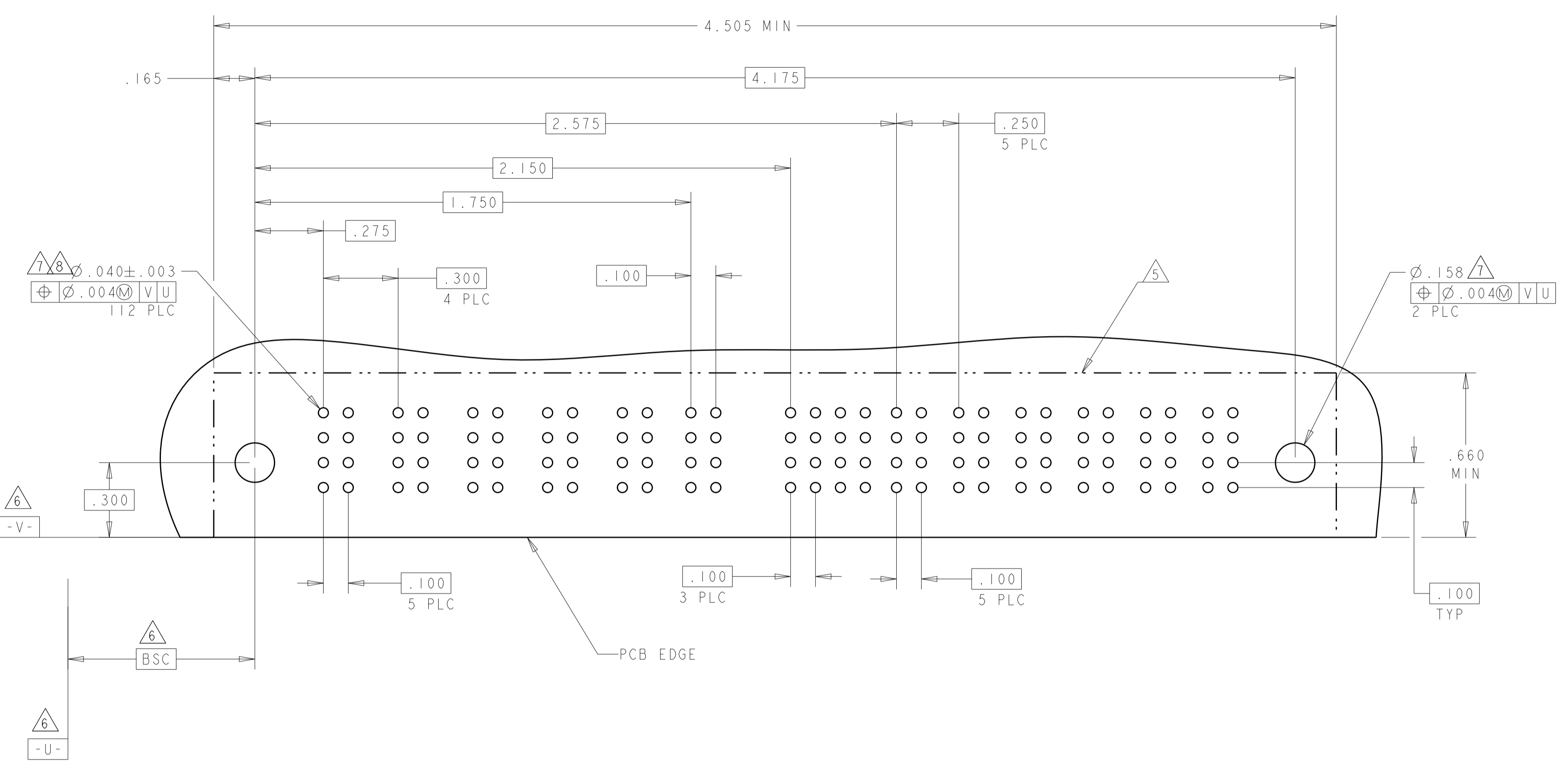

THIS DRAWING IS A CONTROLLED DOCUMENT.		DMN R. GRZYBOWSKI 28FEB05	NAME M. PERCHERKE	TE Connectivity RIGHT ANGLE HEADER ASSEMBLY SOLDER TAILS, W/GUIDES MULTI-BEAM XL
DIMENSIONS: INCHES		CHK M. PERCHERKE	APVD M. PERCHERKE	
TOLERANCES UNLESS OTHERWISE SPECIFIED:		0 PLC ±	PRODUCT SPEC	SIZE 114-13038
1 PLC ±.01 2 PLC ±.01 3 PLC ±.005 4 PLC ±.0020 ANGLES ±.2°		APPLICATION SPEC	RESTRICTED TO	
MATERIAL		FINISH	WEIGHT	SCALE 1:1
CUSTOMER DRAWING		114-13038	19	SHEET 19 OF 19