

THIS DRAWING IS UNPUBLISHED. RELEASED FOR PUBLICATION AUG ,2005.

© COPYRIGHT 2005 BY TYCO ELECTRONICS CORPORATION. ALL RIGHTS RESERVED.

LOC	DIST	REVISIONS					
E	B	P	LTR	DESCRIPTION	DATE	DWN	APVD
		B		ECR-07-011908	16/05/07	AM	FWK

NOTES:

- ELECTRICAL DATA: CONTACT RESISTANCE: 10 mOhm MAX
INSULATION RESISTANCE: 100 MOhm MIN at 500VDC
CURRENT RATING: 5 AMPS
BREAKDOWN VOLTAGE: 500 VAC MIN PER MINUTE
- ENVIRONMENTAL: OPERATING TEMPERATURE: -20°C TO +80°C
SEALING REQUIREMENTS: IP67
- PROD SPEC: 108-3641
- PACKAGING: 107-3334
- FOR TECHNICAL DATA REFER TO YOUR LOCAL TYCO ELECTRONICS SALES OFFICE
- ALL DIMENSIONS ARE NOMINAL FOR REFERENCE ONLY UNLESS OTHERWISE STATED

ITEM	DESCRIPTION	MATERIAL	FINISH/COLOUR	QTY
1	SCREW NUT	ZINC DIE CAST	2.5µm NICKEL PLATED	1
2	CONNECTOR BODY	POLYURETHANE	BLACK	1
3	SOCKET CONTACT	BRASS	0.15µm GOLD PLATED OVER NICKEL	5
4	5 CORE CABLE (CORES 22AWG TO UL2464)	PVC JACKET UV RESISTANT	BLACK	1
5	'O' RING	VITON	GREEN	1

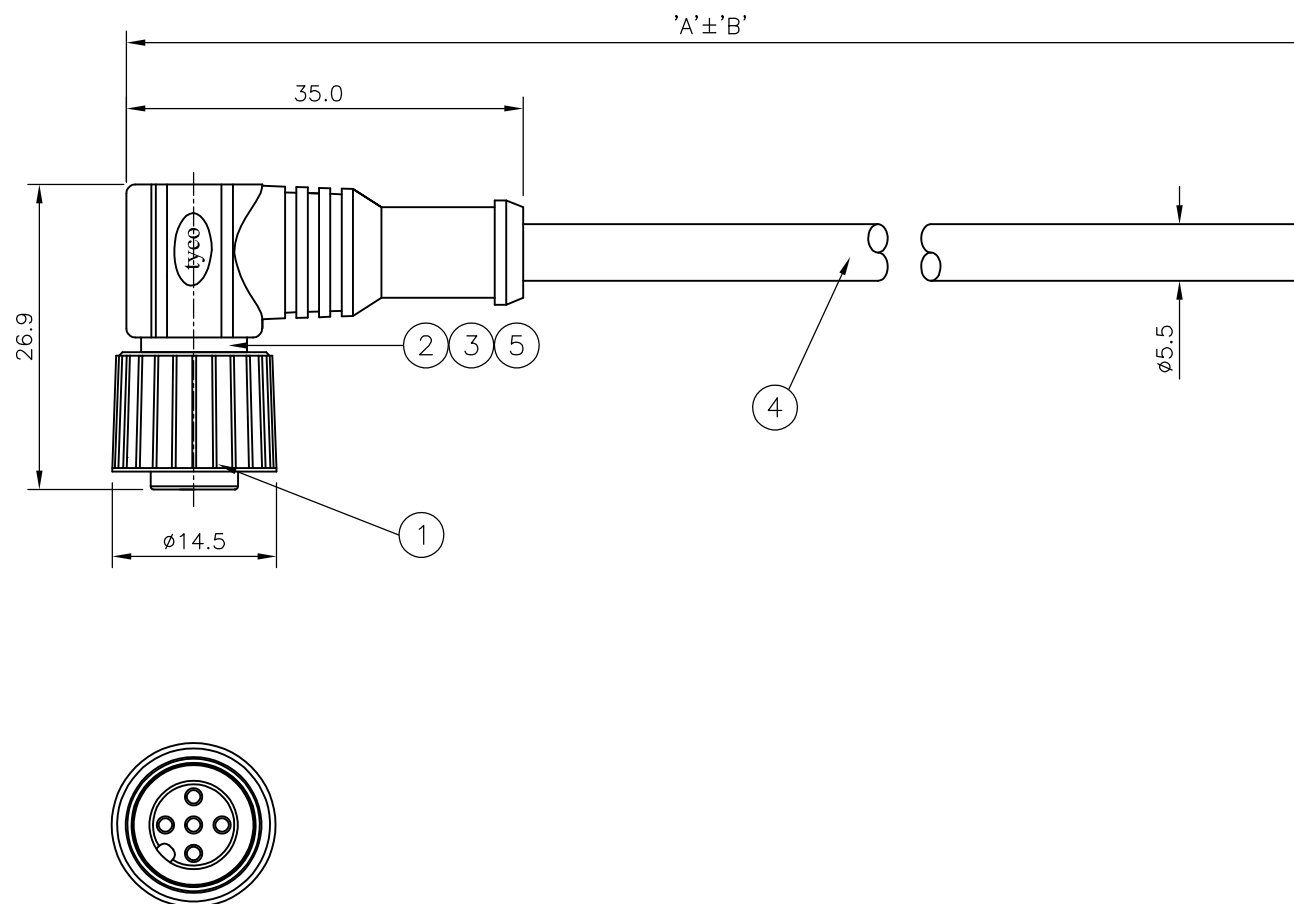
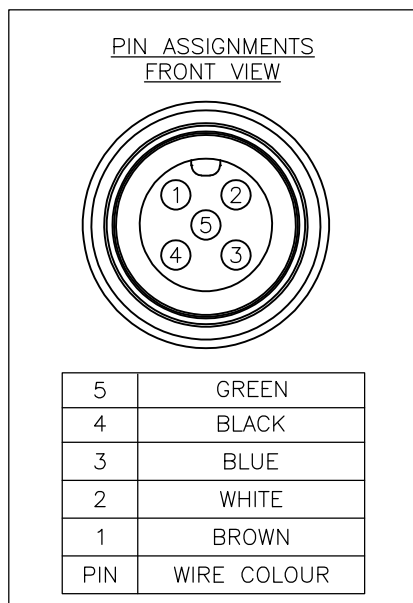

10000	500 mm	M12 RIGHT ANGLED FEMALE CONNECTOR 10.0m CABLE	1838258-5
7000	350 mm	M12 RIGHT ANGLED FEMALE CONNECTOR 7.0m CABLE	1838258-4
5000	250 mm	M12 RIGHT ANGLED FEMALE CONNECTOR 5.0m CABLE	1838258-3
3000	150 mm	M12 RIGHT ANGLED FEMALE CONNECTOR 3.0m CABLE	1838258-2
2000	100 mm	M12 RIGHT ANGLED FEMALE CONNECTOR 2.0m CABLE	1838258-1
DIM A	TOL 'B'	DESCRIPTION	PART NUMBER

THIS DRAWING IS A CONTROLLED DOCUMENT.		DWN H M RAGHAVENDRA 22AUG05	Tyco Electronics Corporation Bideford, UK, EX39 4HE	
DIMENSIONS: mm		CHK F.WHEELER-KING 15DEC05	NAME M12 RIGHT ANGLED FEMALE CONNECTOR 5 POSITION, PVC CABLE	
TOLERANCES UNLESS OTHERWISE SPECIFIED:		APVD F.WHEELER-KING 15DEC05	SIZE A3	
0 PLC ± - 1 PLC ± - 2 PLC ± - 3 PLC ± - 4 PLC ± - ANGLES ± -		PRODUCT SPEC -	CAGE CODE 00779	DRAWING NO C-1838258
MATERIAL -		FINISH -	RESTRICTED TO -	SCALE NTS
CUSTOMER DRAWING			SHEET 1 OF 1	REV B