

## Asynchronous Boost Converter for 10 WLEDs

### General Description

The RT4503/A is a highly integrated LED driver IC capable of driving 10 WLEDs in series. It is composed of a current mode Boost converter integrated with a 36V/1.2A power switch.

The RT4503/A supports a wide input voltage range from 2.5V to 5.5V and runs at a fixed frequency of 550kHz. The LED current is set via an external resistor and the feedback voltage is regulated to 200mV.

For brightness dimming, the RT4503A supports 32 steps pulse dimming which determines the feedback reference voltage, and RT4503 support PWM dimming which determines the feedback reference voltage.

### Applications

- Cellular Phones
- Digital Cameras
- Probable Instruments

### Features

- 2.5V to 5.5V Input Voltage Range
- 36V Open LED Protection for 10 WLEDs
- Pulse Dimming Brightness Control
- 200mV Reference Voltage with  $\pm 2\%$  Accuracy
- 550kHz Switching Frequency
- Built-In Soft-Start
- Over-Temperature Protection
- Internal Compensation
- Current Limit

### Ordering Information

RT4503/A	□□
	Package Type
	QW : WDFN-6L 2x2 (W-Type)
	Lead Plating System
	G : Green (Halogen Free and Pb Free)
	RT4503 : PWM Dimming
	RT4503A : Pulse Dimming

Note :

Richtek products are :

- ▶ RoHS compliant and compatible with the current requirements of IPC/JEDEC J-STD-020.
- ▶ Suitable for use in SnPb or Pb-free soldering processes.

### Simplified Application Circuit

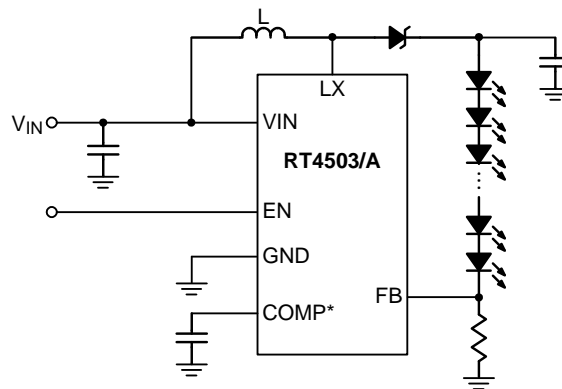

\* : COMP pin for RT4503 only.

## Marking Information

RT4503GQW

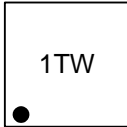

1T : Product Code

W : Date Code

RT4503AGQW

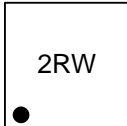

2R : Product Code

W : Date Code

## Pin Configurations

(TOP VIEW)

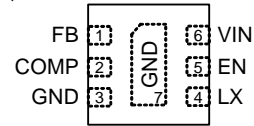

WDFN-6L 2x2

RT4503

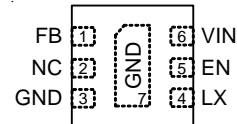

WDFN-6L 2x2

RT4503A

## Functional Pin Description

Pin No.	Pin Name	Pin Function
1	FB	Feedback Voltage Input. Place a resistor between this pin and GND to set the current.
2	COMP (RT4503)	Connect an External Capacitor to this Pin.
	NC (RT4503A)	No Internal Connection.
3, 7 (Exposed Pad)	GND	Ground. The exposed pad must be soldered to a large PCB and connected to GND for maximum thermal dissipation.
4	LX	Switch Node. Connect the pin to the switch side of the inductor.
5	EN	Enable Control Input and Pulse Dimming Input.
6	VIN	Supply Voltage Input.

**Function Block Diagram**

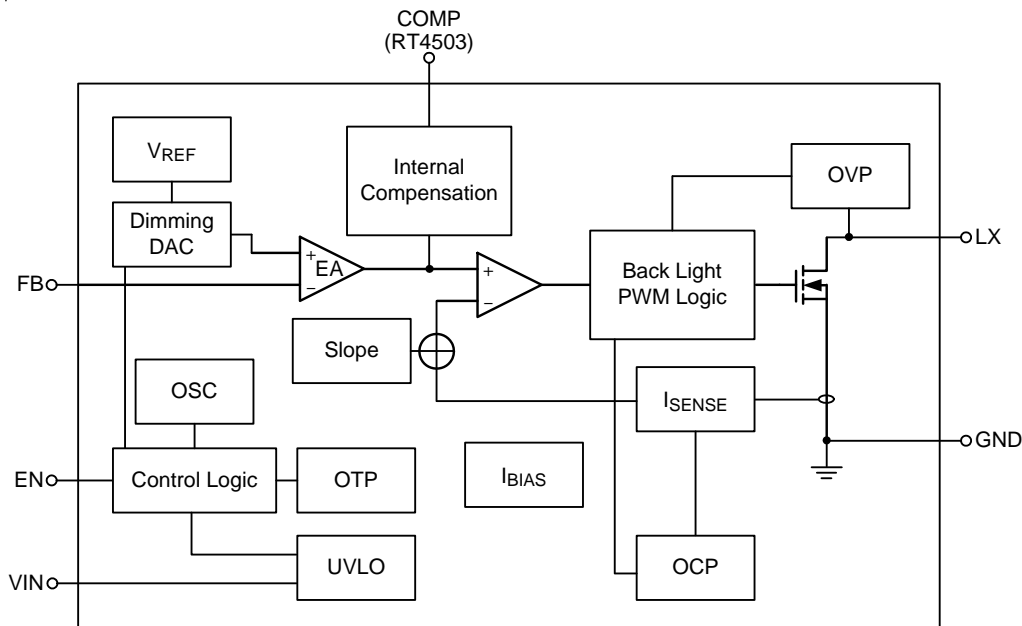

**Operation**

The RT4503/A is a constant frequency, current mode Boost LED driver. In normal operation, the N-MOSFET is turned on when the PWM Control circuit is set by the oscillator and is turned off when the current comparator resets the PWM Control circuit. While the N-MOSFET is turned off, the inductor current conducts through the external diode.

**UVLO**

When the input voltage is lower than the UVLO threshold (2.37V typ.), the driver will turn off. There is a 80mV for the UVLO hysteresis control.

**Soft-Start**

When the device is enabled, the Comp ramps up to the target voltage in a specific time. This ensures that the output voltage rises slowly to reduce the input inrush current.

**EN Dimming**

The EN pin is used for the control input for both PWM dimming mode and digital dimming mode. Shutdown delay when the EN voltage is logic low for more than specific time, the driver will be shut down.

**OCP**

The driver provides cycle-by-cycle current limit function to control the current on power switch.

**OVP**

The over-voltage protection function monitors the output voltage via the LX pin voltage. The OVP threshold voltage is 36V typically. Once the LED is open, the output voltage reaches the OVP threshold, the driver will be shut down.

**OTP**

The over-temperature protection function will shut down the switching operation when the junction temperature exceeds 160°C. Once the junction temperature cools down by approximately 15°C, the converter will automatically resume switching.

## Absolute Maximum Ratings (Note 1)

- VIN ----- -0.3V to 6V
- EN, FB, COMP to GND ----- -0.3V to (VIN + 0.3V)
- LX to GND ----- -0.3V to 38V
- Power Dissipation, PD @ TA = 25°C
  - WDFN-6L 2x2 ----- 2.1W
- Package Thermal Resistance (Note 2)
  - WDFN-6L 2x2, θJA ----- 47.5°C/W
- Junction Temperature ----- 150°C
- Lead Temperature (Soldering, 10 sec.) ----- 260°C
- Storage Temperature Range ----- -65°C to 150°C
- ESD Susceptibility (Note 3)
  - HBM (Human Body Model) ----- 2kV
  - MM (Machine Model) ----- 200V

## Recommended Operating Conditions (Note 4)

- Supply Input Voltage, VIN ----- 2.5V to 5.5V
- Junction Temperature Range ----- -40°C to 125°C
- Ambient Temperature Range ----- -40°C to 85°C

## Electrical Characteristics

(VIN = 3.6V, CIN = 2.2μF, COUT = 1μF, L = 22μH, fsw = 550kHz, TA = 25°C, unless otherwise specified)

Parameter	Symbol	Test Conditions	Min	Typ	Max	Unit
<b>Power Supply</b>						
IC Operating Current (switching)	IQ_SW	VFB = 0V	0.25	0.8	1.5	mA
IC Quiescent Current (non-switching)	IQ	VFB = 0.4V	0.25	0.35	0.5	mA
VIN Pin Shutdown Current	ISHDN	EN = GND	--	0.3	1	μA
Under-Voltage Lockout Threshold	UVLO	VIN Rising Edge	2.25	2.37	2.5	V
Under-Voltage Lockout Hysteresis	UVLO_hys	VIN Falling Edge	--	80	--	mV
<b>Enable and Reference Control</b>						
EN Input Voltage	Logic-High	VIH	1.4	--	--	V
	Logic-Low	VIL	--	--	0.4	
EN Pull Low Resistance	REN		--	300	--	kΩ
EN minimum Shut down Pulse Width	Toff	For RT4503	20	--	--	ms
	Toff	For RT4503A	2	--	--	ms
EN Minimum Logic High Pulse Width	THigh_MIN		0.5	--	--	μs
EN Minimum Logic Low Pulse Width	TLow		0.5	--	1000	μs
Internal Comp Resistance	Rcomp		--	120	--	kΩ
PWM Minimum Duty without IC Shutdown	DPWM MIN	For RT4503, VFB > 0mV	1	--	--	%
PWM Frequency	fPWM	For RT4503	1	--	100	kHz

Parameter	Symbol	Test Conditions	Min	Typ	Max	Unit
<b>Voltage and Current Control</b>						
Feedback Regulation Voltage	V <sub>FB</sub>		196	200	204	mV
Feedback Pin Bias Current	I <sub>FB</sub>		--	--	0.1	μA
Oscillator Frequency	f <sub>SW</sub>		495	550	605	kHz
Maximum Duty Cycle	D <sub>MAX</sub>		--	93	--	%
<b>Power Switch</b>						
N-MOSFET On-Resistance	R <sub>DS(ON)</sub>	V <sub>IN</sub> = 3.6V	--	0.4	0.7	Ω
<b>OC and OLP</b>						
Peak N-MOSFET Current Limit	I <sub>LIM</sub>		1	1.2	1.4	A
Open LED Protection Threshold	OVP		35	36.5	38	V
<b>Thermal Shutdown</b>						
Thermal Shutdown Threshold	T <sub>SD</sub>		--	160	--	°C
Thermal Shutdown Hysteresis	ΔT <sub>SD</sub>		--	15	--	°C

**Note 1.** Stresses beyond those listed “Absolute Maximum Ratings” may cause permanent damage to the device. These are stress ratings only, and functional operation of the device at these or any other conditions beyond those indicated in the operational sections of the specifications is not implied. Exposure to absolute maximum rating conditions may affect device reliability.

**Note 2.** θ<sub>JA</sub> is measured at T<sub>A</sub> = 25°C on a high effective thermal conductivity four-layer test board per JEDEC 51-7.

**Note 3.** Devices are ESD sensitive. Handling precaution is recommended.

**Note 4.** The device is not guaranteed to function outside its operating conditions.

**Note 5.** First EN pulse for pulse dimming see Timing Diagram.

Typical Application Circuit

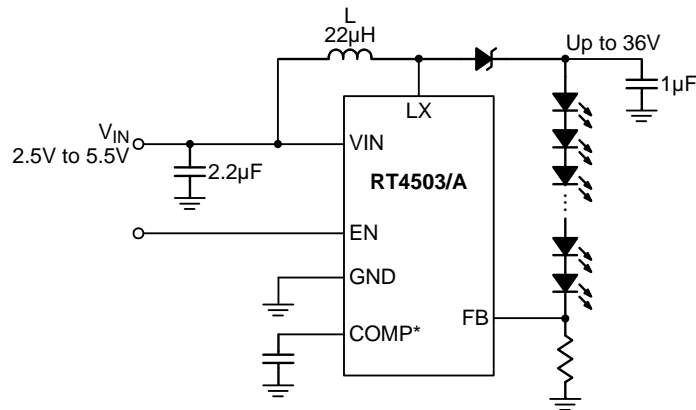

\* : COMP pin for RT4503 only, the 220nF capacitor is suitable for most applications.

Timing Diagram

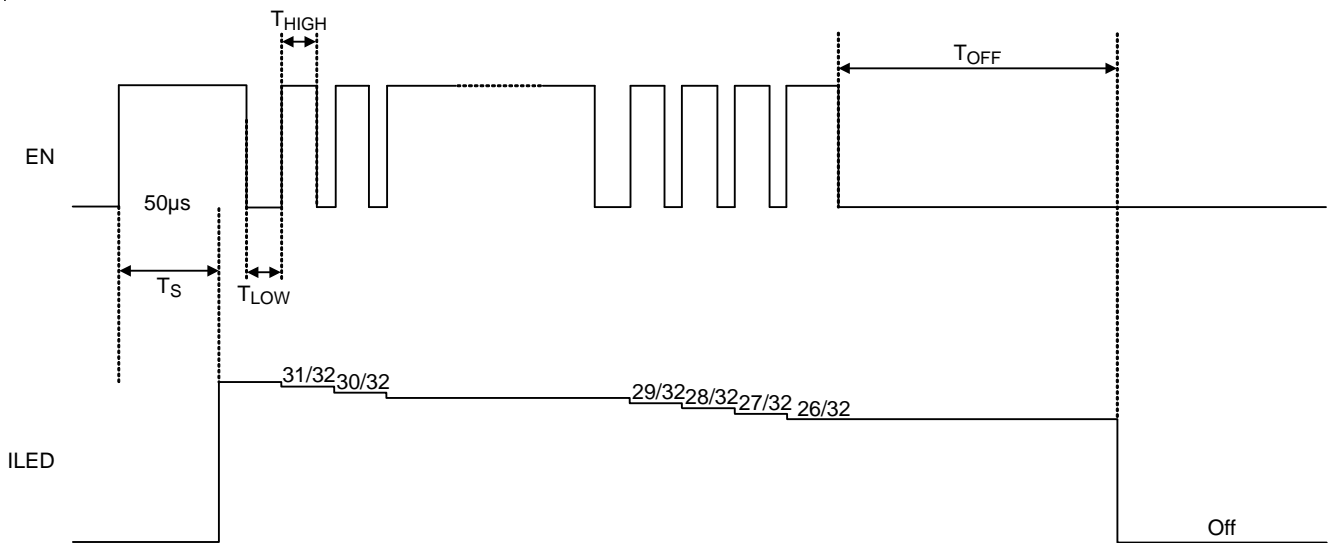

**Typical Operating Characteristics**

**Efficiency vs. Output Current**

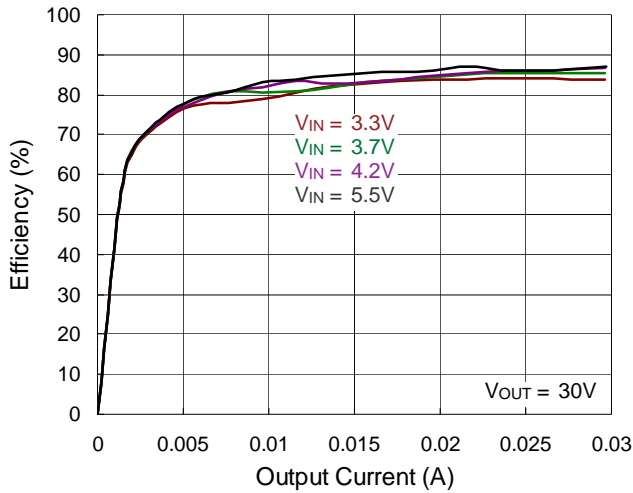

**Efficiency vs. Input Voltage**

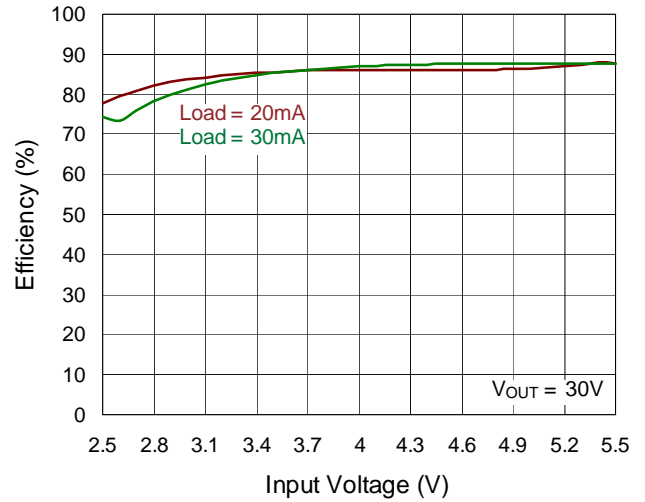

**Quiescent Current vs. Input Voltage**

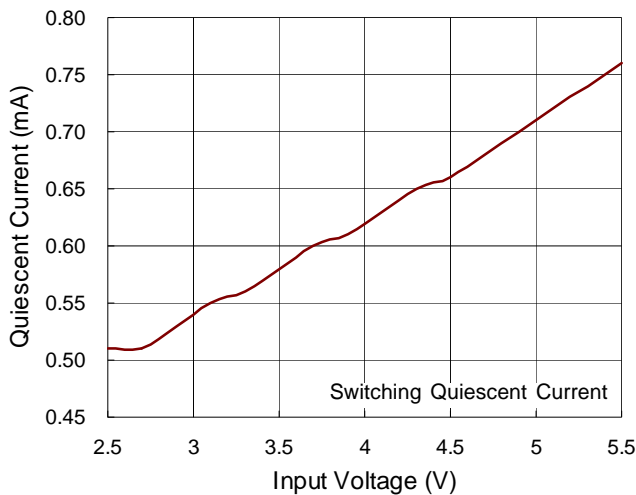

**Quiescent Current vs. Temperature**

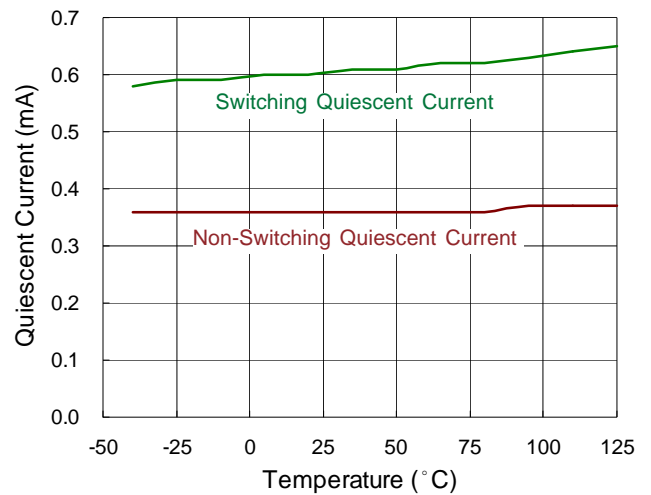

**Oscillator Frequency vs. Input Voltage**

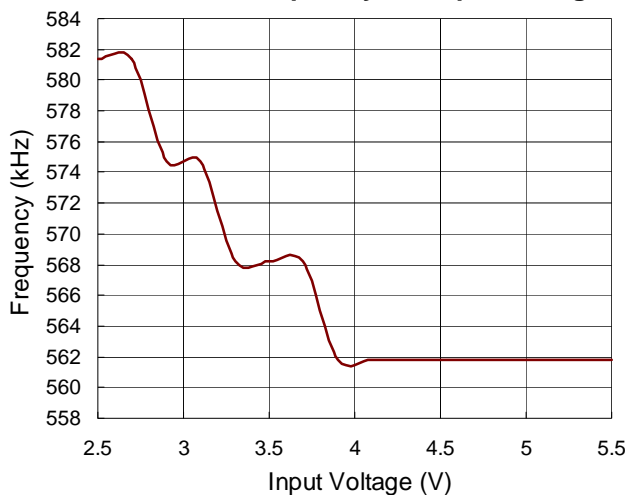

**Oscillator Frequency vs. Temperature**

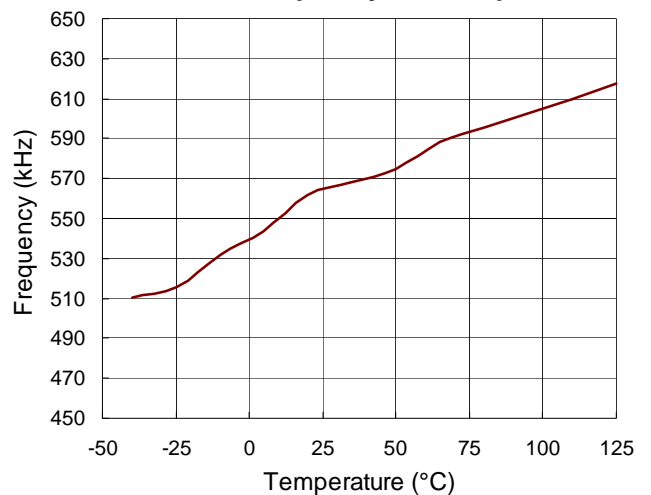

Reference Voltage vs. Input Voltage

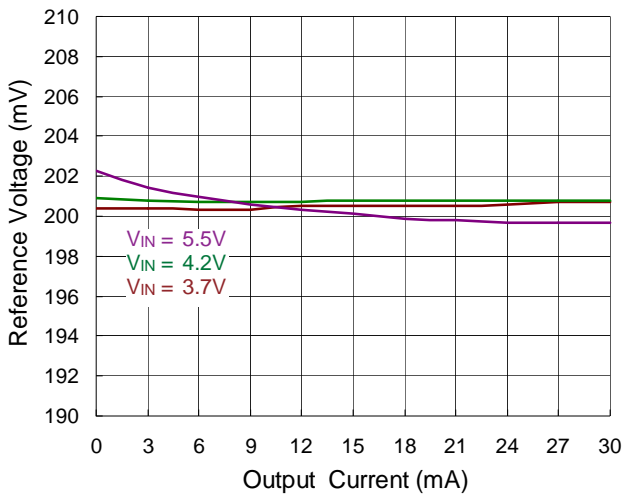

Reference Voltage vs. Output Current

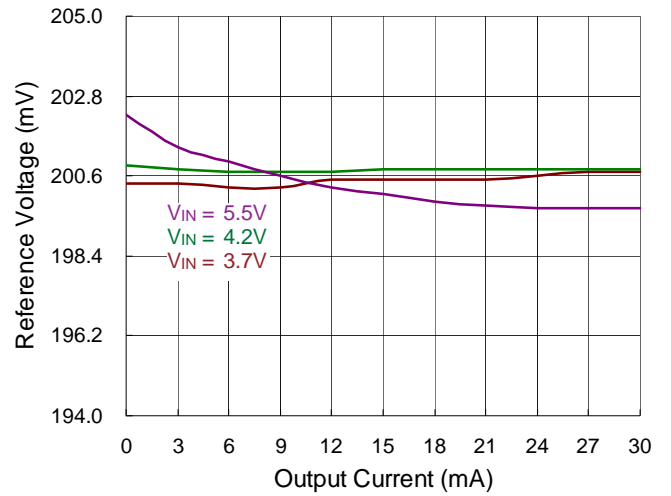

Reference Voltage vs. Pulse Dimming Step

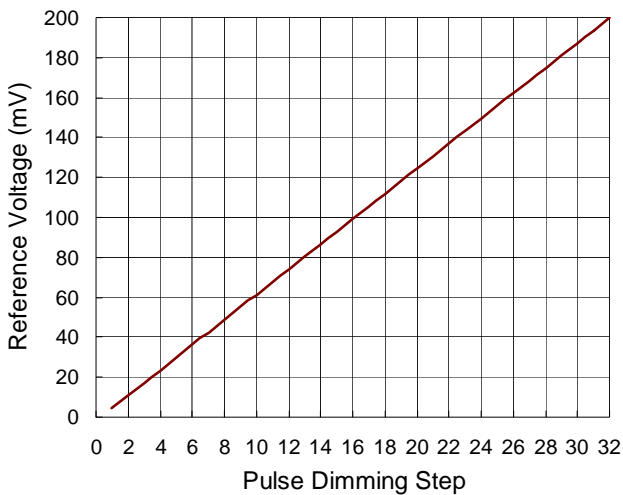

Reference Voltage vs. PWM Dimming Duty Cycle

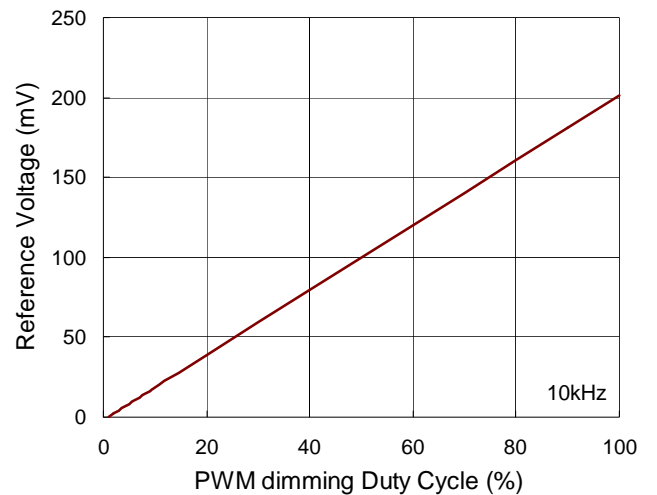

V<sub>IN</sub> Shutdown Current vs. Input Voltage

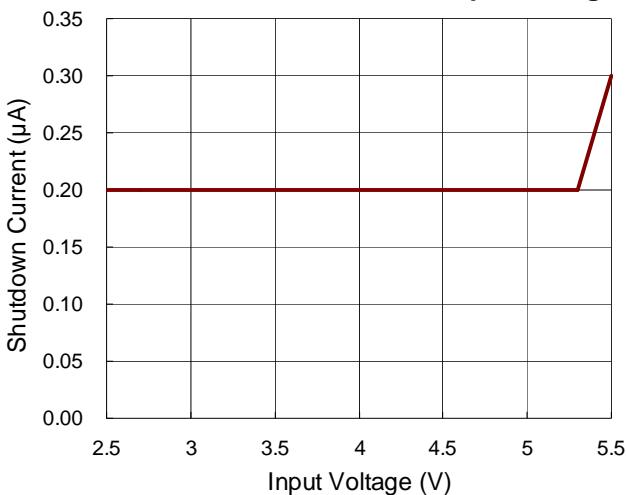

Open LED Protection vs. Input Voltage

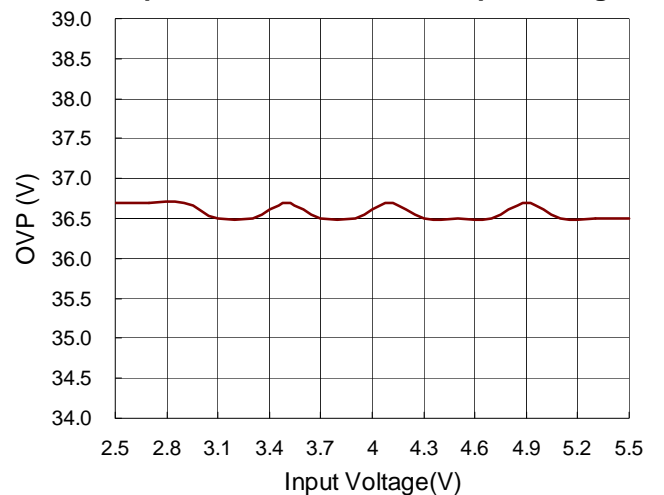



**Power On from EN**

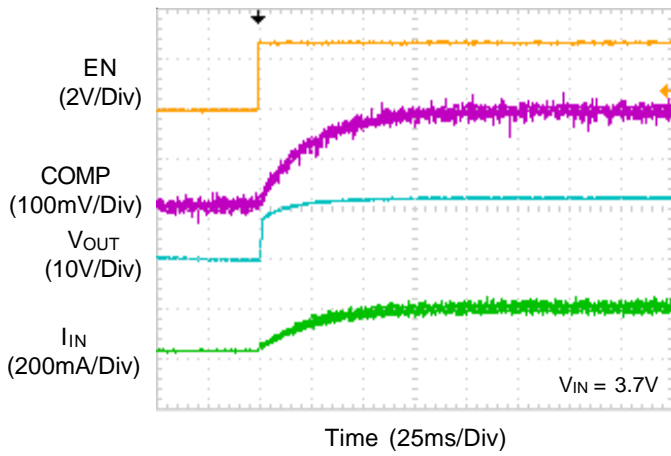

**Power Off from EN**

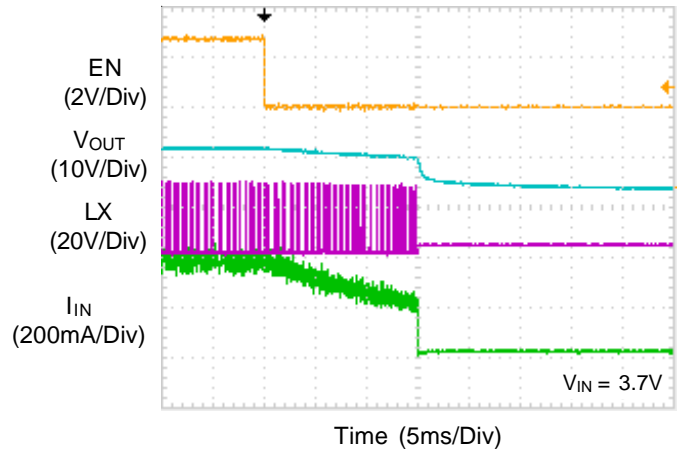

**PWM Dimming**

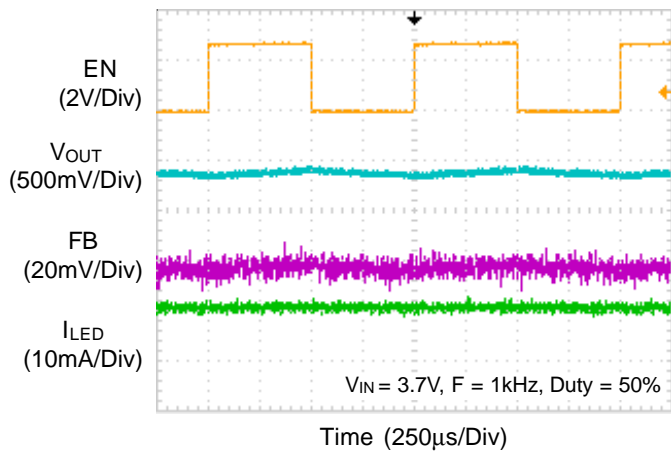

**PWM Dimming**

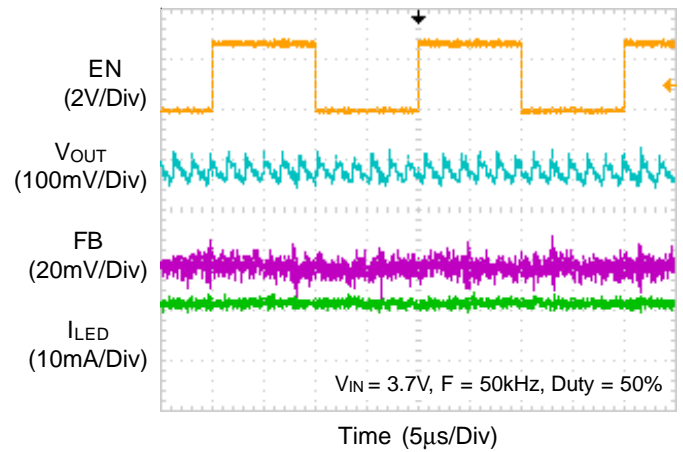

**Pulse Dimming**

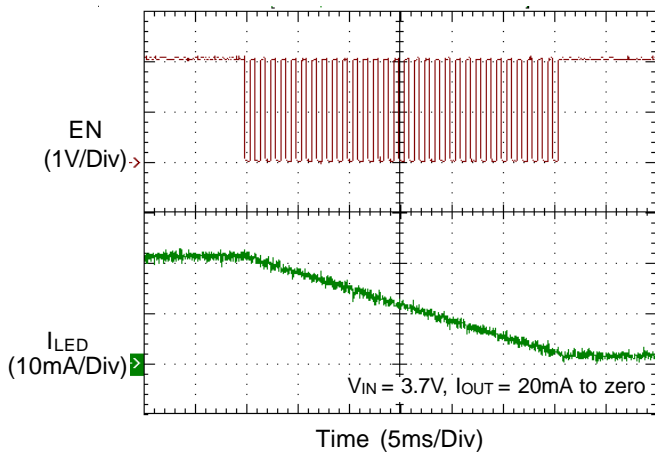

**Pulse Dimming**

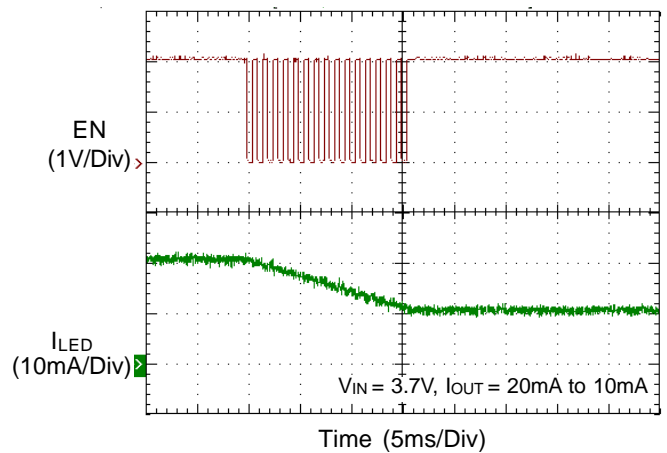

## Application Information

### Soft-Start

The RT4503/A includes a soft-start function to avoid high inrush current during start-up. The soft-start function is achieved by clamping the output voltage of the error amplifier with another voltage source that is increased slowly from zero to near  $V_{IN}$ .

### LED Current

The loop control of the Boost converter keeps  $V_{FB}$  equal to a reference voltage,  $V_{REF}$ . Therefore, when  $R_{SET}$  is connected between the FB pin and GND, the LED current will be determined by the current through  $R_{SET}$ , which is equal to  $V_{FB} / R_{SET}$ .

### Current Limit

The current flowing through the inductor during a charging period is detected by a current sensing circuit. If the value exceeds the current limit, the N-MOSFET will be turned off. The inductor will then be forced to leave charging stage and enter discharging stage. Therefore, the inductor current will not increase to reach current limit.

### Shutdown Delay

When the EN voltage is in logic low for 20ms during PWM dimming for RT4503 and 2ms during pulse dimming for RT4503A, the system will enter shutdown.

### PWM Dimming

When the EN pin is constantly high, the FB voltage is regulated to 200mV typically. The RT4503 allows a PWM signal from EN pin to reduce the regulation voltage; and achieve LED brightness dimming. The relationship between the duty cycle and FB voltage is given by

$$V_{FB} = \text{Duty} \times V_{REF}$$

Where :

Duty = duty cycle of the PWM signal

$V_{REF}$  = internal reference voltage (200mV typ.)

The RT4503 chops up the internal 200mV reference voltage via the duty cycle of the PWM signal. Therefore, although a PWM signal is used for brightness dimming, only the LED DC current is modulated, which is often referred as analog dimming. This eliminates the audible noise which often occurs when the LED current is pulsed in replica of the frequency and duty cycle of PWM control. For optimum performance, use the PWM dimming frequency in the range of 1kHz to 100kHz.

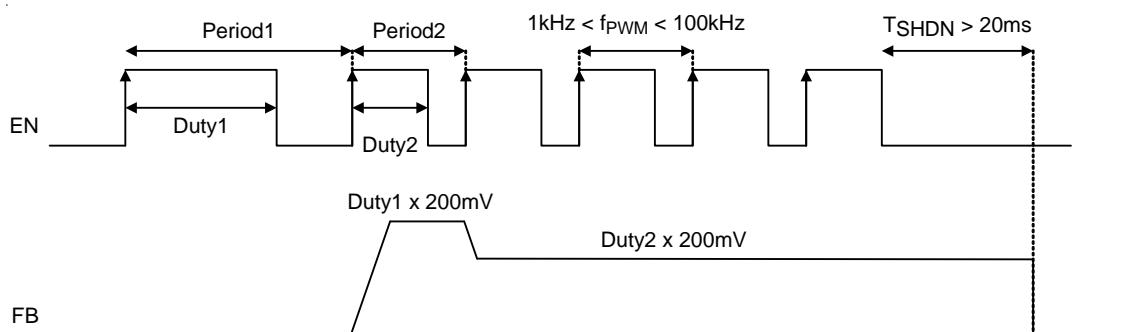

**Pulse Dimming**

The EN pin features a simple digital interface to allow digital brightness control. Using the digital interface to control the LED brightness does not require a PWM signal.

The digital brightness control is implemented by adjusting the feedback voltage in digital steps with a typical maximum voltage of  $V_{FB} = 200mV$ . For this purpose, a 5-bit DAC is used to display 32 steps equaling to a 6.25mV change in feedback voltage per step.

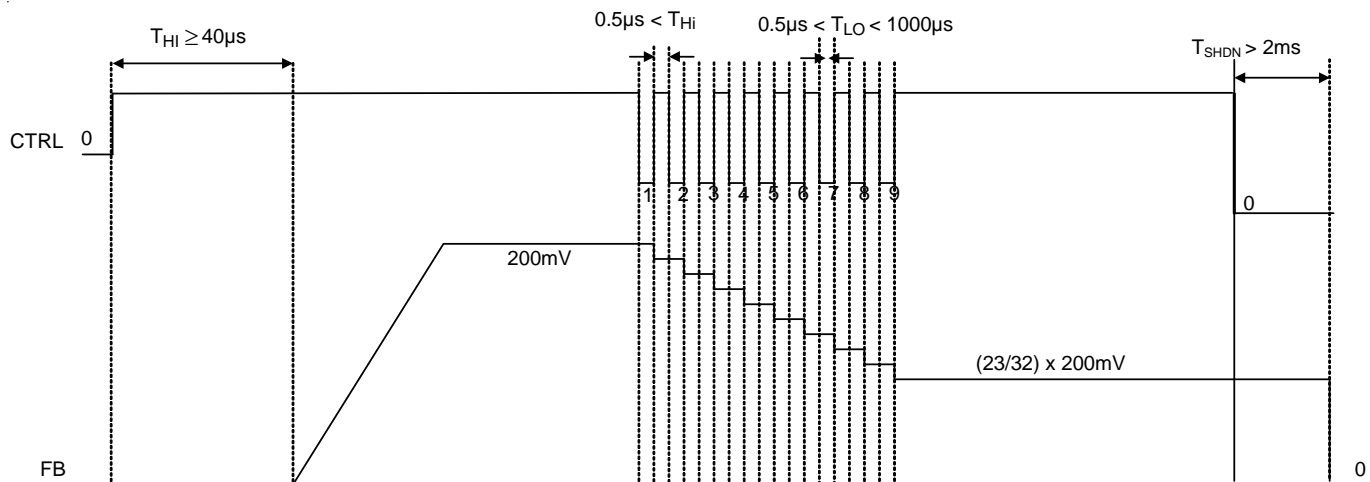

**Inductor Selection**

The recommended value of inductor for 10 LEDs or high brightness LED applications is 22µH. Smaller size and better efficiency are the major concerns for portable devices. The inductor should have low core loss at 550kHz and low DCR for better efficiency. The inductor saturation current rating should be considered to cover the inductor peak current.

**Capacitor Selection**

For low ripple voltage, ceramic capacitors with low ESR are recommended. X5R and X7R types are suitable because of their wide voltage range and good operating temperature characteristics. For the application of the RT4503/A to drive 10 LEDs in series, a 2.2µF for input capacitor, a 1µF for output capacitor.

**Thermal Considerations**

For continuous operation, do not exceed absolute maximum junction temperature. The maximum power dissipation depends on the thermal resistance of the IC package, PCB layout, rate of surrounding airflow, and difference between junction and ambient temperature. The

maximum power dissipation can be calculated by the following formula :

$$P_{D(MAX)} = (T_{J(MAX)} - T_A) / \theta_{JA}$$

where  $T_{J(MAX)}$  is the maximum junction temperature,  $T_A$  is the ambient temperature, and  $\theta_{JA}$  is the junction to ambient thermal resistance.

For recommended operating condition specifications, the maximum junction temperature is 125°C. The junction to ambient thermal resistance,  $\theta_{JA}$ , is layout dependent. For WDFN-6L 2x2 package, the thermal resistance,  $\theta_{JA}$ , is 47.5°C/W on a standard JEDEC 51-7 four-layer thermal test board. The maximum power dissipation at  $T_A = 25^\circ C$  can be calculated by the following formula :

$$P_{D(MAX)} = (125^\circ C - 25^\circ C) / (47.5^\circ C/W) = 2.1W \text{ for WDFN-6L 2x2 package}$$

The maximum power dissipation depends on the operating ambient temperature for fixed  $T_{J(MAX)}$  and thermal resistance,  $\theta_{JA}$ . The derating curve in Figure 1 allows the designer to see the effect of rising ambient temperature on the maximum power dissipation.

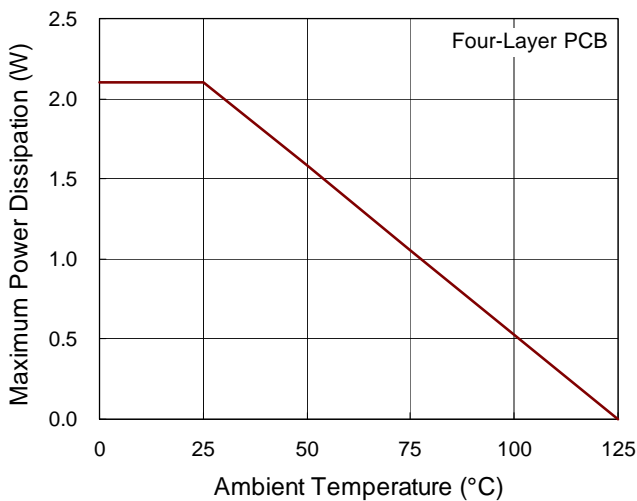

Figure 1. Derating Curve of Maximum Power Dissipation

**Layout Consideration**

For best performance of the RT4503/A, the following guide lines must be strictly followed.

- ▶ Input and Output capacitors should be placed close to the IC and connected to ground plane to reduce noise coupling.
- ▶ The GND and Exposed Pad should be connected to a strong ground plane for heat sinking and noise protection.
- ▶ Keep the main current traces as possible as short and wide.
- ▶ LX node of DC/DC converter is with high frequency voltage swing. It should be kept at a small area.
- ▶ Place the feedback components as close as possible to the IC and keep away from the noisy devices.

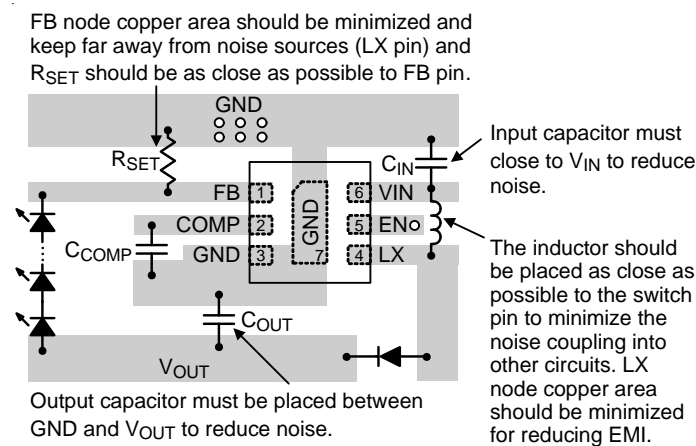
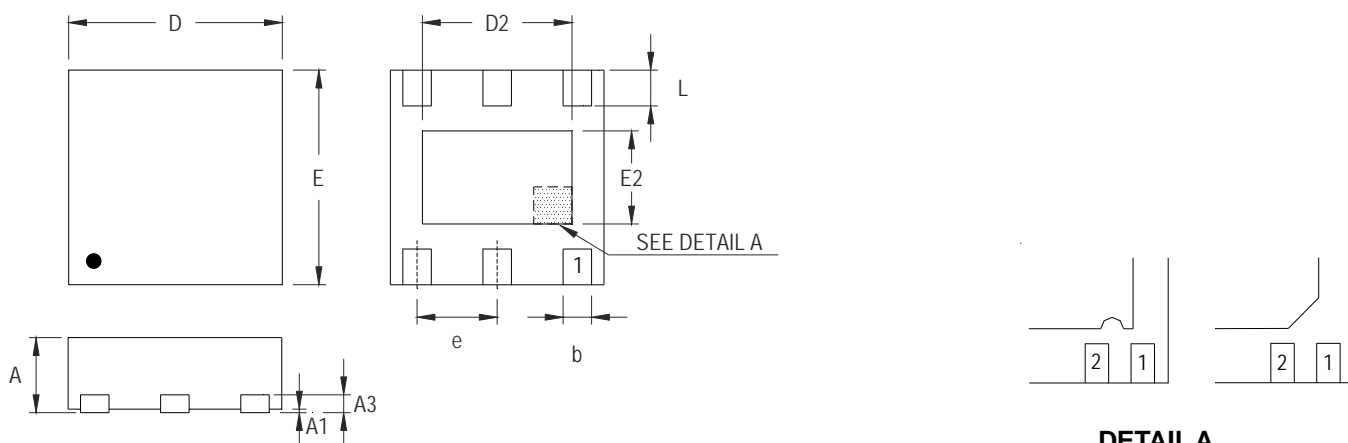

Figure 2. PCB Layout Guide

**Outline Dimension**



**DETAIL A**  
Pin #1 ID and Tie Bar Mark Options

Note : The configuration of the Pin #1 identifier is optional, but must be located within the zone indicated.

Symbol	Dimensions In Millimeters		Dimensions In Inches	
	Min	Max	Min	Max
A	0.700	0.800	0.028	0.031
A1	0.000	0.050	0.000	0.002
A3	0.175	0.250	0.007	0.010
b	0.200	0.350	0.008	0.014
D	1.950	2.050	0.077	0.081
D2	1.000	1.450	0.039	0.057
E	1.950	2.050	0.077	0.081
E2	0.500	0.850	0.020	0.033
e	0.650		0.026	
L	0.300	0.400	0.012	0.016

**W-Type 6L DFN 2x2 Package**

**Richtek Technology Corporation**

14F, No. 8, Tai Yuen 1<sup>st</sup> Street, Chupei City  
Hsinchu, Taiwan, R.O.C.  
Tel: (8863)5526789

Richtek products are sold by description only. Richtek reserves the right to change the circuitry and/or specifications without notice at any time. Customers should obtain the latest relevant information and data sheets before placing orders and should verify that such information is current and complete. Richtek cannot assume responsibility for use of any circuitry other than circuitry entirely embodied in a Richtek product. Information furnished by Richtek is believed to be accurate and reliable. However, no responsibility is assumed by Richtek or its subsidiaries for its use; nor for any infringements of patents or other rights of third parties which may result from its use. No license is granted by implication or otherwise under any patent or patent rights of Richtek or its subsidiaries.