

SECTION Z-Z

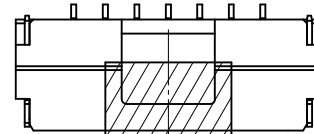

カプトンテープ付き
WITH KAPTON TAPE

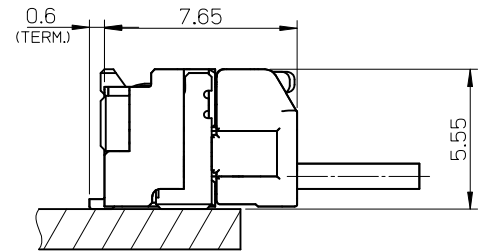
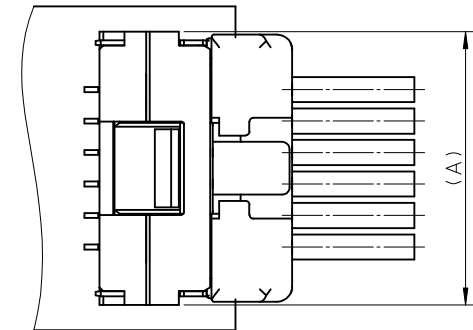

嵌合図

MATED CONNECTORS

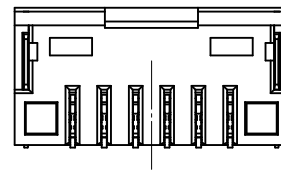
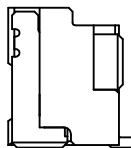
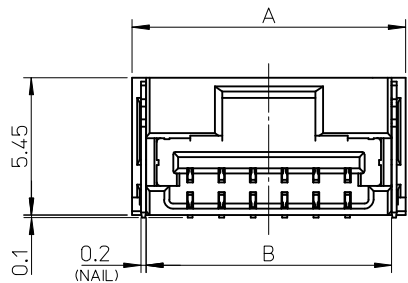

NOTES

1. 嵌合相手: 502380-****
MATE WITH : 502380-****
2. 端子テール部 及び ネイルの平坦度: 0.1MAX.
TAIL AND NAIL COPLANARITY TO BE 0.1 MAX.
3. 極数/2=偶数に適用.
APPLY FOR CKT. SIZE / 2 = EVEN.
4. 端子テール部 及び ネイルに錫めっきを使用しているため、
外観に摺動痕が付く場合が御座います。
THE WOUND OF FRICTION MIGHT ADHERE TO EXTERNALS
BECAUSE THE TIN PLATING IS USED FOR THA TAIL AND NAIL.
5. 本製品のプラスチック部に黒点等が確認される場合や
色合いが異なる場合がありますが、製品性能に影響はありません。
THERE IS NO INFLUENCE IN THE PRODUCT PERFORMANCE THOUGH
THE BLACK SPOT ETC. MIGHT BE CONFIRMED TO THE PLASTIC PART
OF THIS PRODUCT AND THE SHADE MIGHT BE DIFFERENT.
6. ELV 及び RoHS 適合品
ELV AND RoHS COMPLIANT

| | | | | | |
|-----|------|------|-------|---|----------------|
| 3.4 | 7.5 | 11 | 12.1 | 502386-07** | 7 |
| 3.4 | 6.25 | 9.75 | 10.85 | 502386-06** | 6 |
| 3.4 | 5 | 8.5 | 9.6 | 502386-05** | 5 |
| 3.4 | 3.75 | 7.25 | 8.35 | 502386-04** | 4 |
| 2.6 | 2.5 | 6 | 7.1 | 502386-03** | 3 |
| 2.2 | 1.25 | 4.75 | 5.85 | 502386-02** | 2 |
| D | C | B | A | EMBOSSED TAPE PACKAGE オーダー番号 ORDER No. | 極数 CKT. NO. |

| 番号 NO. | 部品 PART | 材質 MATERIAL |
|-----------|-------------------|--|
| ① | ハウジング HOUSING | 耐熱性樹脂 UL94V-0 色:SHEET 3 参照 HEATPROOF RESIN UL94V-0 COLOR : SEE SHEET 3 |
| ② | ターミナル TERMINAL | 銅合金 COPPER ALLOY 錫めっき : 1.0 micro-meter MIN. TIN (TAIL AREA) ニッケルめっき(下地): 1.0 micro-meter MIN. NICKEL (UNDER PLATING) |
| ③ | ネイル NAIL | 銅合金 COPPER ALLOY 錫めっき: 1.0 micro-meter MIN. TIN ニッケルめっき(下地): 1.0 micro-meter MIN. NICKEL (UNDER PLATING) |

| | | | | | | | | | |
|---|--------------------|--|-------------------------------|----------------------------|---------------------|--|--|---------------------------|--|
| REVISED EC NO.: J2013-0870 DRWN: KWASHIO 2013/02/07 CHKD: KASAKAWA 2013/02/13 APPR: YO ITO 2013/02/13 | DESCRIPTION REV | GENERAL TOLERANCES (UNLESS SPECIFIED) | | DIMENSION STYLE MM ONLY | | SCALE 5:1 | DESIGN UNITS METRIC | THIRD ANGLE PROJECTION | |
| | | 10 UNDER | ±0.2 | DRAWN BY T. MIYAZAKI | DATE 2006/08/28 | TITLE 1.25 W/B CONN. SINGLE R/A REC. ASS'Y 2-7CKT. | | | |
| | | 10 OVER 30 UNDER | ±0.25 | CHECKED BY K. ASAKAWA | DATE 2006/08/28 | | | | |
| | | 30 OVER | ±0.3 | APPROVED BY YO. ITO | DATE 2006/08/28 | | | | |
| ANGULAR ±3 ° DRAFT WHERE APPLICABLE MUST REMAIN WITHIN DIMENSIONS | | MATERIAL NO. SEE TABLE | DOCUMENT NO. SD-502386-001 | | SHEET NO. 1 OF 3 | | THIS DRAWING CONTAINS INFORMATION THAT IS PROPRIETARY TO MOLEX INCORPORATED AND SHOULD NOT BE USED WITHOUT WRITTEN PERMISSION | | |



2 CKT.

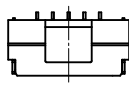

5 CKT.



3 CKT.

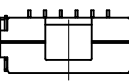

6 CKT.

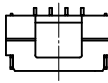

4 CKT.

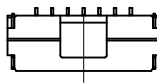

7 CKT.

極数の種類

KIND OF CKT. NO.(FRONT VIEW)

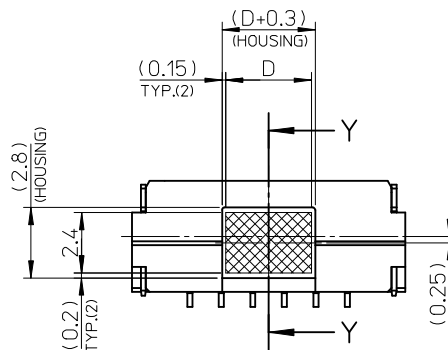

吸着範囲
VACUME AREA

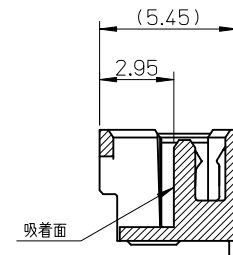

SECTION Y-Y

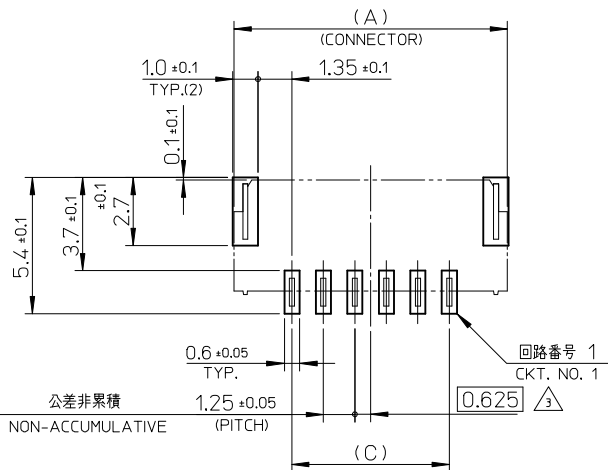

基板パターンレイアウト (参考)
RECCOMENDED P.C.B. PATTERN LAYOUT (REF.)

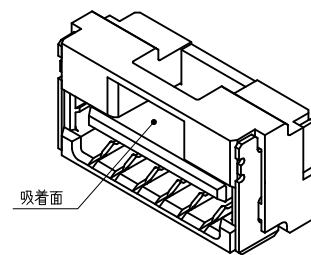

| | | | | | | | |
|---|---------------------------------------|---------------------------|----------------------------|--|--|------------------------|------------------------|
| REVISED EC NO.: J2013-0870 2013/02/07 DRWN:KWASHIO 2013/02/13 CHKD:KASAKAWA 2013/02/13 APPR:Y01ITO 2013/02/13 | GENERAL TOLERANCES (UNLESS SPECIFIED) | | DIMENSION STYLE MM ONLY | | SCALE 5:1 | DESIGN UNITS METRIC | THIRD ANGLE PROJECTION |
| | 10 UNDER | ± 0.2 | DRAWN BY T. MIYAZAKI | DATE 2006/08/28 | TITLE 1.25 W/B CONN. SINGLE R/A REC. ASS'Y 2-7CKT. | | |
| | 10 OVER 30 UNDER | ± 0.25 | CHECKED BY K. ASAKAWA | DATE 2006/08/28 | molex DOCUMENT NO. SD-502386-001 SHEET NO. 2 OF 3 | | |
| | 30 OVER | ± 0.3 | APPROVED BY Y01. ITO | DATE 2006/08/28 | | | |
| ANGULAR | ± 3 ° | MATERIAL NO. SEE TABLE | | THIS DRAWING CONTAINS INFORMATION THAT IS PROPRIETARY TO MOLEX INCORPORATED AND SHOULD NOT BE USED WITHOUT WRITTEN PERMISSION | | | |
| DRAFT WHERE APPLICABLE MUST REMAIN WITHIN DIMENSIONS | | SIZE A3 | | | | | |

| WITH CAPTON TAPE | | | | | | | | | | |
|---|------------------------------|---|------------------------------|---|------------------------------|---|------------------------------|---|------------------------------|-----------------|
| HSG COLOR : GREEN | | HSG COLOR : BLUE | | HSG COLOR : RED | | HSG COLOR : BLACK | | HSG COLOR : NATURAL | | |
| 502386-0736 | 502386-**16 | 502386-0734 | 502386-**14 | 502386-0732 | 502386-**12 | 502386-0731 | 502386-**11 | 502386-0772 | 502386-**08 | 7 |
| 502386-0636 | | 502386-0634 | | 502386-0632 | | 502386-0631 | | 502386-0672 | | 6 |
| 502386-0536 | | 502386-0534 | | 502386-0532 | | 502386-0531 | | 502386-0572 | | 5 |
| 502386-0436 | | 502386-0434 | | 502386-0432 | | 502386-0431 | | 502386-0472 | | 4 |
| 502386-0336 | | 502386-0334 | | 502386-0332 | | 502386-0331 | | 502386-0372 | | 3 |
| 502386-0236 | | 502386-0234 | | 502386-0232 | | 502386-0231 | | 502386-0272 | | 2 |
| EMBOSSSED TAPE PACKAGE オーダー番号ORDER No. | コネクタ シリズ CONNECTOR SIRIES | EMBOSSSED TAPE PACKAGE オーダー番号ORDER No. | コネクタ シリズ CONNECTOR SIRIES | EMBOSSSED TAPE PACKAGE オーダー番号ORDER No. | コネクタ シリズ CONNECTOR SIRIES | EMBOSSSED TAPE PACKAGE オーダー番号ORDER No. | コネクタ シリズ CONNECTOR SIRIES | EMBOSSSED TAPE PACKAGE オーダー番号ORDER No. | コネクタ シリズ CONNECTOR SIRIES | 極数 (XT. NO.) |

| WITHOUT CAPTON TAPE | | | | | | | | | | |
|---|------------------------------|---|------------------------------|---|------------------------------|---|------------------------------|---|------------------------------|-----------------|
| HSG COLOR : GREEN | | HSG COLOR : BLUE | | HSG COLOR : RED | | HSG COLOR : BLACK | | HSG COLOR : NATURAL | | |
| 502386-0746 | 502386-**26 | 502386-0744 | 502386-**24 | 502386-0742 | 502386-**22 | 502386-0741 | 502386-**21 | 502386-0770 | 502386-**09 | 7 |
| 502386-0646 | | 502386-0644 | | 502386-0642 | | 502386-0641 | | 502386-0670 | | 6 |
| 502386-0546 | | 502386-0544 | | 502386-0542 | | 502386-0541 | | 502386-0570 | | 5 |
| 502386-0446 | | 502386-0444 | | 502386-0442 | | 502386-0441 | | 502386-0470 | | 4 |
| 502386-0346 | | 502386-0344 | | 502386-0342 | | 502386-0341 | | 502386-0370 | | 3 |
| 502386-0246 | | 502386-0244 | | 502386-0242 | | 502386-0241 | | 502386-0270 | | 2 |
| EMBOSSSED TAPE PACKAGE オーダー番号ORDER No. | コネクタ シリズ CONNECTOR SIRIES | EMBOSSSED TAPE PACKAGE オーダー番号ORDER No. | コネクタ シリズ CONNECTOR SIRIES | EMBOSSSED TAPE PACKAGE オーダー番号ORDER No. | コネクタ シリズ CONNECTOR SIRIES | EMBOSSSED TAPE PACKAGE オーダー番号ORDER No. | コネクタ シリズ CONNECTOR SIRIES | EMBOSSSED TAPE PACKAGE オーダー番号ORDER No. | コネクタ シリズ CONNECTOR SIRIES | 極数 (XT. NO.) |

| | | | | | | | | |
|---|--|---|---|--|---|-------------------------------|---------------------------|--|
| REVISED EC NO: J2013-0870 2013/02/07 DRWN:KAWASHIO 2013/02/13 CHKD:KASAKAWA 2013/02/13 APPR:Y0 ITO 2013/02/13 | GENERAL TOLERANCES (UNLESS SPECIFIED) | | DIMENSION STYLE MM ONLY | | SCALE ---- | DESIGN UNITS METRIC | THIRD ANGLE PROJECTION | |
| | 10 UNDER | ±0.2 | DRAWN BY DATE T.MIYAZAKI 2006/08/28 | | TITLE 1.25 W/B CONN. SINGLE R/A REC. ASS'Y 2-7CKT. | | | |
| | 10 OVER 30 UNDER | ±0.25 | CHECKED BY DATE K.ASAKAWA 2006/08/28 | |  | | | |
| | 30 OVER | ±0.3 | APPROVED BY DATE Y0. ITO 2006/08/28 | | | | | |
| | ANGULAR ±3 ° | | MATERIAL NO. SEE TABLE | | DOCUMENT NO. SD-502386-001 | | SHEET NO. 3 OF 3 | |
| DRAFT WHERE APPLICABLE MUST REMAIN WITHIN DIMENSIONS | | SIZE A3 THIS DRAWING CONTAINS INFORMATION THAT IS PROPRIETARY TO MOLEX INCORPORATED AND SHOULD NOT BE USED WITHOUT WRITTEN PERMISSION | | | | | | |

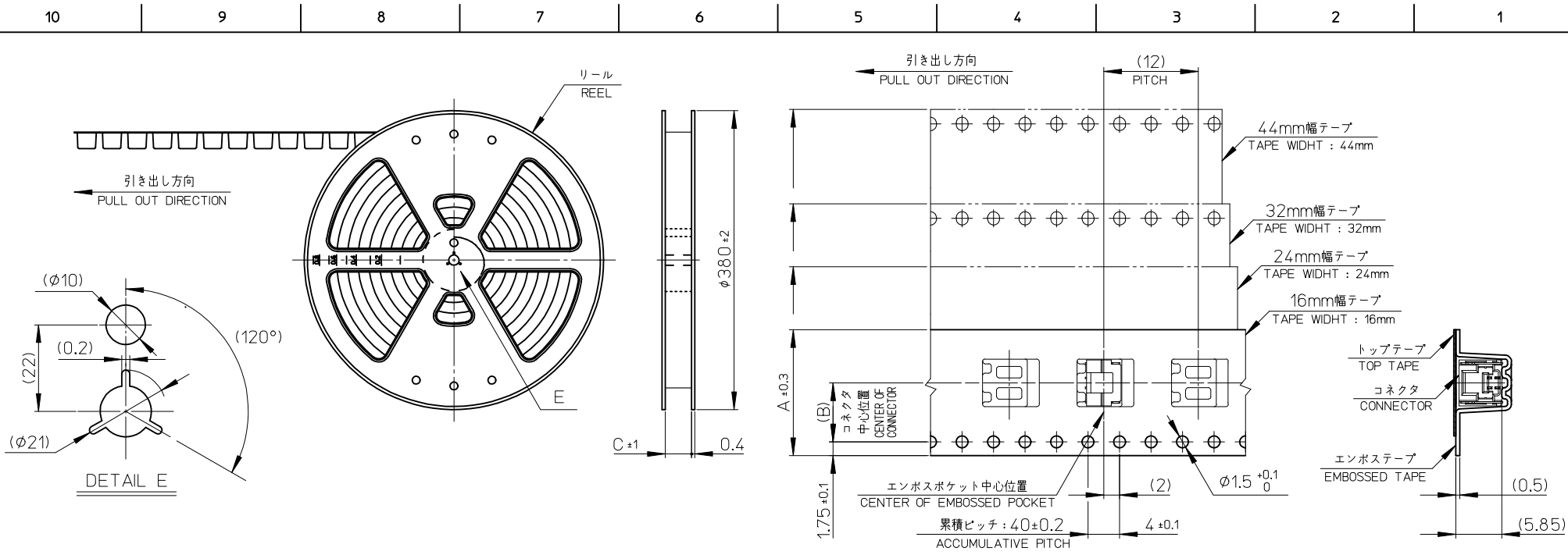

NOTES

- 製品詳細寸法については、SD-502386-001, -002 を参照下さい。
PLEASE REFER TO SD-502386-001, -002 FOR THE DETAILED DIMENSION OF THE CONNECTOR.
- 梱包数量 : 1200個
NUMBER OF CONNECTORS : 1200 PIECES/REEL.
- リードテープ長さ
LEAD TAPE LENGTH

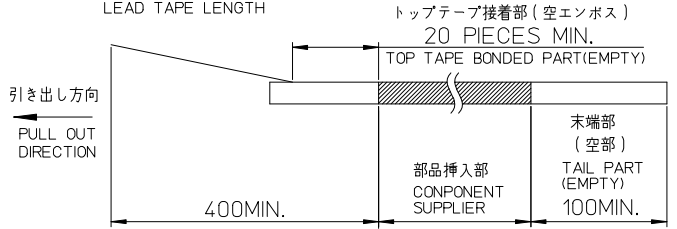

- 材料
MATERIAL
キャリアテープ : ポリスチレン
CARRIER TAPE : POLYSTYRENE
トップテープ : ポリエステル, ポリエチレン, ポリエチレンテレフタレート
TOP TAPE : POLYESTER, POLYETHYLENE, POLYETHYLENE TEREPHTHALATE
リール : ポリスチレン <リサイクル材を含む>
REEL : POLYSTYRENE <RECYCLE MATERIAL CONTAINED>
- ELV 及び RoHS 適合品
ELV AND RoHS COMPLIANT

| | | | | |
|------|------|----|-------------|----|
| 45.5 | 20.2 | 44 | 502386-15** | 15 |
| 45.5 | 20.2 | 44 | 502386-14** | 14 |
| 33.5 | 14.2 | 32 | 502386-13** | 13 |
| 33.5 | 14.2 | 32 | 502386-12** | 12 |
| 33.5 | 14.2 | 32 | 502386-11** | 11 |
| 33.5 | 14.2 | 32 | 502386-10** | 10 |
| 25.5 | 11.5 | 24 | 502386-09** | 9 |
| 25.5 | 11.5 | 24 | 502386-08** | 8 |
| 25.5 | 11.5 | 24 | 502386-07** | 7 |
| 25.5 | 11.5 | 24 | 502386-06** | 6 |
| 25.5 | 11.5 | 24 | 502386-05** | 5 |
| 25.5 | 11.5 | 24 | 502386-04** | 4 |
| 17.5 | 7.5 | 16 | 502386-03** | 3 |
| 17.5 | 7.5 | 16 | 502386-02** | 2 |

| | | | | | | | | | | | |
|--|-------------|--|-------|----------------------------|------------|---|------------------------|--|------------------------|---------------------|--|
| REVISED EC NO: J2013-0870 DRAWN: KAWASHIO 2013/02/07 CHKD: KASAKAWA 2013/02/13 APPR: Y01ITO 2013/02/13 | DESCRIPTION | GENERAL TOLERANCES (UNLESS SPECIFIED) | | DIMENSION STYLE MM ONLY | | SCALE --- | DESIGN UNITS METRIC | | THIRD ANGLE PROJECTION | | |
| | | 10 UNDER | ±0.2 | DRAWN BY | DATE | TITLE | | | | | |
| | | 10 OVER 30 UNDER | ±0.25 | T. MIYAZAKI | 2006/10/16 | 1.25 W/B CONN. SINGLE R/A REC. EMBTP PKG | | | | | |
| | | 30 OVER | ±0.3 | CHECKED BY | DATE | K. ASAKAWA 2006/10/16 | | | | | |
| REV | DESCRIPTION | ANGULAR ±3 ° | | APPROVED BY | | DATE | MATERIAL NO. | | | | |
| | | DRAFT WHERE APPLICABLE MUST REMAIN WITHIN DIMENSIONS | | Y0. ITO | | 2006/10/16 | DOCUMENT NO. | | | | |
| | | | | SIZE | | THIS DRAWING CONTAINS INFORMATION THAT IS PROPRIETARY TO MOLEX INCORPORATED AND SHOULD NOT BE USED WITHOUT WRITTEN PERMISSION | | | | | |
| | | | | A3 | | SEE TABLE | | | | | |
| | | | | | | SD-502386-003 | | | | SHEET NO. 1 OF 2 | |

| WITHOUT CAPTON TAPE | | | WITH CAPTON TAPE | | | | | | | | | | |
|---------------------|--------------|-------------|-------------------|--------------|------------------|--------------|------------------|--------------|-------------------|--------------|---------------------|--------------|-----------|
| HSG COLOR : ORANGE | | | HSG COLOR : GREEN | | HSG COLOR : BLUE | | HSG COLOR : RED | | HSG COLOR : BLACK | | HSG COLOR : NATURAL | | |
| 502386-**28 | --// | 15 | --// | --// | --// | --// | --// | --// | --// | --// | --// | --// | 15 |
| | --// | 14 | --// | --// | --// | --// | --// | --// | --// | --// | --// | --// | 14 |
| | --// | 13 | --// | --// | --// | --// | --// | --// | --// | --// | --// | --// | 13 |
| | --// | 12 | --// | --// | --// | --// | --// | --// | --// | --// | --// | --// | 12 |
| | --// | 11 | --// | --// | --// | --// | --// | --// | --// | --// | --// | --// | 11 |
| | --// | 10 | --// | --// | --// | --// | --// | --// | --// | --// | --// | --// | 10 |
| | 502386-0948 | 9 | --// | --// | --// | --// | --// | --// | --// | --// | --// | --// | 9 |
| | --// | 8 | --// | --// | --// | --// | --// | --// | --// | --// | --// | --// | 8 |
| | --// | 7 | --// | --// | --// | --// | --// | --// | --// | --// | --// | --// | 7 |
| | --// | 6 | --// | --// | --// | --// | --// | --// | --// | --// | --// | --// | 6 |
| --// | 5 | 502386-0736 | 502386-0636 | 502386-0734 | 502386-0634 | 502386-0732 | 502386-0632 | 502386-0731 | 502386-0631 | 502386-0730 | 502386-0630 | 502386-0729 | 7 |
| --// | 4 | 502386-0536 | 502386-0436 | 502386-0534 | 502386-0434 | 502386-0532 | 502386-0432 | 502386-0531 | 502386-0431 | 502386-0530 | 502386-0430 | 502386-0529 | 6 |
| --// | 3 | 502386-0436 | 502386-0336 | 502386-0434 | 502386-0334 | 502386-0432 | 502386-0332 | 502386-0431 | 502386-0331 | 502386-0430 | 502386-0330 | 502386-0429 | 5 |
| --// | 2 | 502386-0336 | 502386-0236 | 502386-0334 | 502386-0234 | 502386-0332 | 502386-0232 | 502386-0331 | 502386-0231 | 502386-0330 | 502386-0230 | 502386-0329 | 4 |
| コネクタ シリーズ | 製品番号 | 極数 | コネクタ シリーズ | 製品番号 | コネクタ シリーズ | 製品番号 | コネクタ シリーズ | 製品番号 | コネクタ シリーズ | 製品番号 | コネクタ シリーズ | 製品番号 | 極数 |
| CONNECTOR SERIES | MATERIAL NO. | (KT. NO.) | CONNECTOR SERIES | MATERIAL NO. | CONNECTOR SERIES | MATERIAL NO. | CONNECTOR SERIES | MATERIAL NO. | CONNECTOR SERIES | MATERIAL NO. | CONNECTOR SERIES | MATERIAL NO. | (KT. NO.) |

| WITHOUT CAPTON TAPE | | | | | | | | | | | | | | | | | |
|---------------------|--------------|------------------|------------------|------------------|--------------|--------------------|--------------|------------------|-----------------|-----------|----|-------------------|--|--|---------------------|--|--|
| HSG COLOR : GREEN | | | HSG COLOR : BLUE | | | HSG COLOR : YELLOW | | | HSG COLOR : RED | | | HSG COLOR : BLACK | | | HSG COLOR : NATURAL | | |
| 502386-**26 | 502386-1546 | 502386-1544 | --// | 502386-1542 | 502386-1541 | 502386-1570 | 15 | | | | | | | | | | |
| | 502386-1446 | 502386-1444 | --// | 502386-1442 | 502386-1441 | 502386-1470 | 14 | | | | | | | | | | |
| | 502386-1346 | 502386-1344 | --// | 502386-1342 | 502386-1341 | 502386-1370 | 13 | | | | | | | | | | |
| | 502386-1246 | 502386-1244 | --// | 502386-1242 | 502386-1241 | 502386-1270 | 12 | | | | | | | | | | |
| | 502386-1146 | 502386-1144 | --// | 502386-1142 | 502386-1141 | 502386-1170 | 11 | | | | | | | | | | |
| | 502386-1046 | 502386-1044 | --// | 502386-1042 | 502386-1041 | 502386-1070 | 10 | | | | | | | | | | |
| | 502386-0946 | 502386-0944 | 502386-0943 | 502386-0942 | 502386-0941 | 502386-0970 | 9 | | | | | | | | | | |
| | 502386-0846 | 502386-0844 | --// | 502386-0842 | 502386-0841 | 502386-0870 | 8 | | | | | | | | | | |
| | 502386-0746 | 502386-0744 | --// | 502386-0742 | 502386-0741 | 502386-0770 | 7 | | | | | | | | | | |
| | 502386-0646 | 502386-0644 | --// | 502386-0642 | 502386-0641 | 502386-0670 | 6 | | | | | | | | | | |
| | 502386-0546 | 502386-0544 | --// | 502386-0542 | 502386-0541 | 502386-0570 | 5 | | | | | | | | | | |
| | 502386-0446 | 502386-0444 | --// | 502386-0442 | 502386-0441 | 502386-0470 | 4 | | | | | | | | | | |
| | 502386-0346 | 502386-0344 | --// | 502386-0342 | 502386-0341 | 502386-0370 | 3 | | | | | | | | | | |
| | 502386-0246 | 502386-0244 | --// | 502386-0242 | 502386-0241 | 502386-0270 | 2 | | | | | | | | | | |
| | コネクタ シリーズ | 製品番号 | コネクタ シリーズ | 製品番号 | コネクタ シリーズ | 製品番号 | コネクタ シリーズ | 製品番号 | コネクタ シリーズ | 製品番号 | 極数 | | | | | | |
| CONNECTOR SERIES | MATERIAL NO. | CONNECTOR SERIES | MATERIAL NO. | CONNECTOR SERIES | MATERIAL NO. | CONNECTOR SERIES | MATERIAL NO. | CONNECTOR SERIES | MATERIAL NO. | (KT. NO.) | | | | | | | |

| | | | | | | | | |
|---|---------------------------------------|----------------|-----------------------------------|---|---|-------------------------------|------------------------|--|
| REVISED EC NO.: J2013-0870 DRWN: KWASHIO 2013/02/13 CHKD: KASAKAWA 2013/02/13 APPR: Y01TO 2013/02/13 | GENERAL TOLERANCES (UNLESS SPECIFIED) | | DIMENSION STYLE MM ONLY | | SCALE --- | DESIGN UNITS METRIC | THIRD ANGLE PROJECTION | |
| | 10 UNDER | ±0.2 | DRAWN BY | DATE | TITLE | | | |
| | 10 OVER 30 UNDER | ±0.25 | T. MIYAZAKI | 2006/10/16 | 1.25 W/B CONN. SINGLE R/A REC. EMBTP PKG | | | |
| | 30 OVER | ±0.3 | K. ASAKAWA | 2006/10/16 |  | | | |
| | ANGULAR ±3 ° | | APPROVED BY | DATE | MATERIAL NO. | | DOCUMENT NO. | |
| DRAFT WHERE APPLICABLE MUST REMAIN WITHIN DIMENSIONS | | SEE TABLE | | SD-502386-003 | | 2 OF 2 | | |
| | | SIZE A3 | | THIS DRAWING CONTAINS INFORMATION THAT IS PROPRIETARY TO MOLEX INCORPORATED AND SHOULD NOT BE USED WITHOUT WRITTEN PERMISSION | | | | |

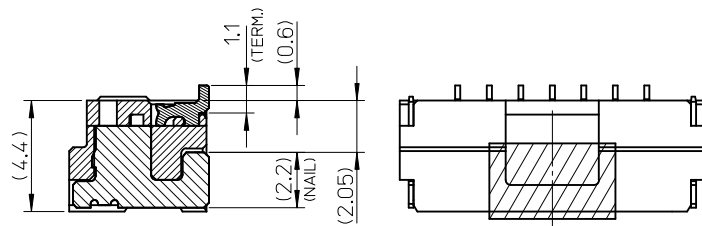
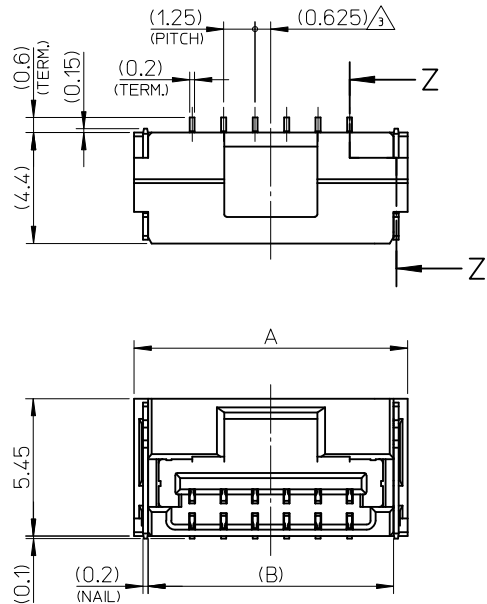

SECTION Z-Z

カプトンテープ付き
WITH KAPTON TAPE

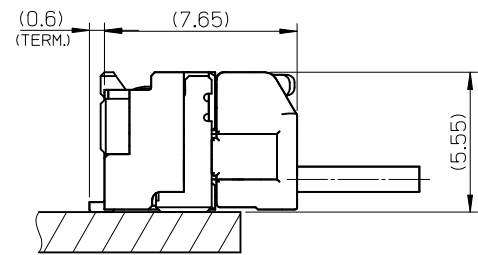
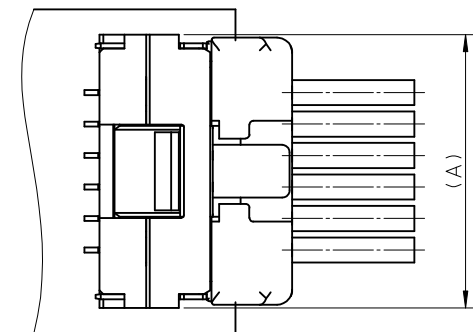
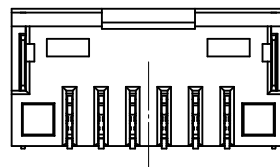
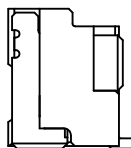

嵌合図

MATED CONNECTORS

NOTES

1. 嵌合相手: 502380-****
MATE WITH : 502380-****
2. 端子テール部 及び ネイルの平坦度: 0.1MAX.
TAIL AND NAIL COPLANARITY TO BE 0.1 MAX.
3. 極数/2=偶数に適用.
APPLY FOR CKT. SIZE / 2 = EVEN.
4. 端子テール部 及び ネイルに錫めっきを使用しているため、
外観に摺動痕が付く場合が御座います。
THE WOUND OF FRICTION MIGHT ADHERE TO EXTERNALS
BECAUSE THE TIN PLATING IS USED FOR THA TAIL AND NAIL.
5. 本製品のプラスチック部に黒点等が確認される場合や
色合いが異なる場合がありますが、製品性能に影響はありません。
THERE IS NO INFLUENCE IN THE PRODUCT PERFORMANCE THOUGH
THE BLACK SPOT ETC. MIGHT BE CONFIRMED TO THE PLASTIC PART
OF THIS PRODUCT AND THE SHADE MIGHT BE DIFFERENT.
6. ELV 及び RoHS 適合品
ELV AND RoHS COMPLIANT

| | | | | | |
|-----|------|------|-------|---|----------------|
| 3.4 | 7.5 | 11 | 12.1 | 502386-0707 | 7 |
| 3.4 | 6.25 | 9.75 | 10.85 | 502386-0607 | 6 |
| 3.4 | 5 | 8.5 | 9.6 | 502386-0507 | 5 |
| 3.4 | 3.75 | 7.25 | 8.35 | 502386-0407 | 4 |
| 2.6 | 2.5 | 6 | 7.1 | 502386-0307 | 3 |
| 2.2 | 1.25 | 4.75 | 5.85 | 502386-0207 | 2 |
| D | C | B | A | EMBOSSED TAPE PACKAGE オーダー番号 ORDER No. | 極数 CKT. NO. |

| 番号 NO. | 部品 PART | 材質 MATERIAL |
|-----------|-------------------|---|
| ① | ハウジング HOUSING | 耐熱性樹脂 UL94V-0 色: ナチュラル HEATPROOF RESIN UL94V-0 COLOR : NATURAL |
| ② | ターミナル TERMINAL | 銅合金 COPPER ALLOY 金めっき : 0.1 micro-meter MIN. GOLD ニッケルめっき(下地): 1.0 micro-meter MIN. NICKEL (UNDER PLATING) |
| ③ | ネイル NAIL | 銅合金 COPPER ALLOY 錫めっき: 1.0 micro-meter MIN. TIN ニッケルめっき(下地): 1.0 micro-meter MIN. NICKEL (UNDER PLATING) |

| | | | | | | | |
|--|--|-----------|----------------------------|---|--------------|---|---------------------------|
| RELEASED EC NO.: J2016-0012 DRWN: TAKAIKE 2015/07/23 CHKD: KASAKAWA 2015/07/21 APPR: NUKITA 2015/07/21 | GENERAL TOLERANCES (UNLESS SPECIFIED) | | DIMENSION STYLE MM ONLY | | SCALE | DESIGN UNITS METRIC | THIRD ANGLE PROJECTION |
| | 0.25 UNDER | UNDER | ±0.03 | DRAWN BY | DATE | TITLE | |
| | 0.25 OVER | 0.5 UNDER | ±0.05 | TAKAIKE | 2015/02/23 | 1.25 W/B CONN. SINGLE R/A REC. ASS'Y 2-7CKT. | |
| | 0.5 OVER | 1.0 UNDER | ±0.1 | CHECKED BY | DATE | | |
| 1.0 OVER | 10 UNDER | ±0.2 | KASAKAWA | 2015/07/21 | | | |
| 10 OVER | 30 UNDER | ±0.25 | APPROVED BY | DATE | | | |
| 30 OVER | | ±0.3 | NUKITA | 2015/07/21 | | | |
| ANGULAR | ±3 ° | | MATERIAL NO. | | DOCUMENT NO. | SHEET NO. | |
| DRAFT WHERE APPLICABLE MUST REMAIN WITHIN DIMENSIONS | | | SIZE A3 | SEE TABLE THIS DRAWING CONTAINS INFORMATION THAT IS PROPRIETARY TO MOLEX INCORPORATED AND SHOULD NOT BE USED WITHOUT WRITTEN PERMISSION | | | |



2 CKT.



3 CKT.



4 CKT.

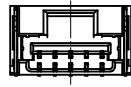
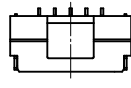

5 CKT.

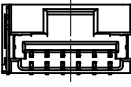
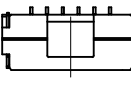

6 CKT.

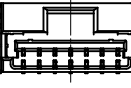
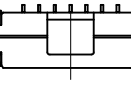

7 CKT.

極数の種類

KIND OF CKT. NO.(FRONT VIEW)

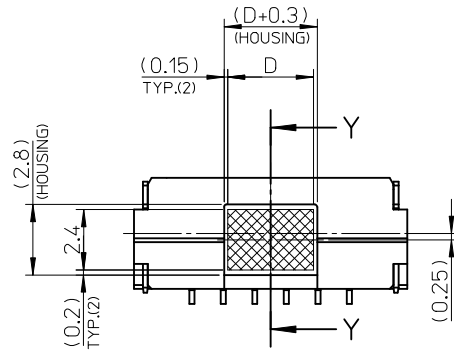

吸着範囲
VACUME AREA

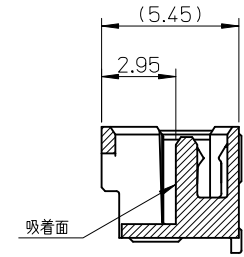

SECTION Y-Y

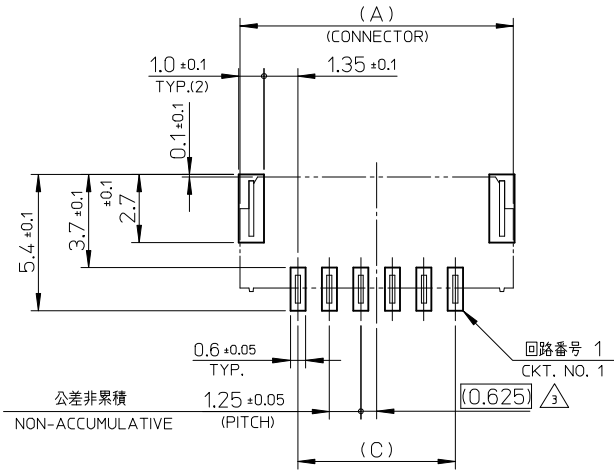

公差非累積
NON-ACCUMULATIVE

基板パターンレイアウト (参考)

RECCOMENDED P.C.B. PATTERN LAYOUT (REF.)

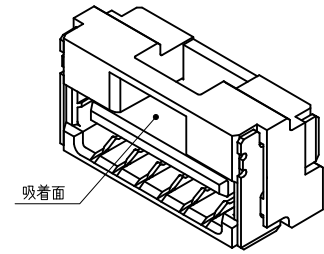

吸着面

| | | | | | | | | |
|--|---------------------------------------|-----------|---|----------------------------|---------------|-------|---|------------------------|
| RELEASED EC NO: J2016-0012 DRWN:TAKAIKE 2015/07/23 CHKD:KASAKAWA 2015/07/21 APPR:NUKITA 2015/07/21 | GENERAL TOLERANCES (UNLESS SPECIFIED) | | | DIMENSION STYLE MM ONLY | | SCALE | DESIGN UNITS METRIC | THIRD ANGLE PROJECTION |
| | 0.25 UNDER | UNDER | ± 0.03 | DRAWN BY | DATE | TITLE | 1.25 W/B CONN. SINGLE R/A REC. ASS'Y 2-7CKT. | |
| | 0.25 OVER | 0.5 UNDER | ± 0.05 | TAKAIKE | 2015/02/23 | | | |
| | 0.5 OVER | 1.0 UNDER | ± 0.1 | CHECKED BY | DATE | | | |
| | 1.0 OVER | 10 UNDER | ± 0.2 | KASAKAWA | 2015/07/21 | | | |
| 10 OVER | 30 UNDER | ± 0.25 | APPROVED BY | DATE | | | | |
| 30 OVER | | ± 0.3 | NUKITA | 2015/07/21 | | | | |
| ANGULAR | ± 3 ° | | MATERIAL NO. | | DOCUMENT NO. | | SHEET NO. | |
| DRAFT WHERE APPLICABLE MUST REMAIN WITHIN DIMENSIONS | | | SEE TABLE | | SD-502386-006 | | 2 OF 2 | |
| | | | THIS DRAWING CONTAINS INFORMATION THAT IS PROPRIETARY TO MOLEX INCORPORATED AND SHOULD NOT BE USED WITHOUT WRITTEN PERMISSION | | | | | |