



GaAs PHEMT MMIC DRIVER AMPLIFIER, 18 - 40 GHz

Typical Applications

The HMC635LC4 is ideal for:

- Point-to-Point Radios
- Point-to-Multi-Point Radios & VSAT
- LO Driver for Mixers
- Military & Space

Features

- Gain: 18.5 dB [2]
- P1dB: +22 dBm [2]
- Output IP3: +27 dBm
- Saturated Power: +23.5 dBm @ 15% PAE [2]
- Supply Voltage: +5V @ 280 mA
- 50 Ohm Matched Input/Output
- 24 Lead Ceramic 4x4mm SMT Package: 16mm²

Functional Diagram

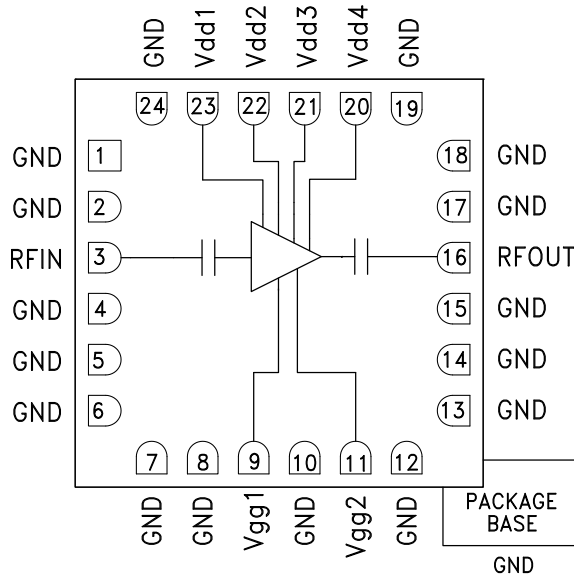

General Description

The HMC635LC4 is a GaAs PHEMT MMIC Driver Amplifier die which operates between 18 and 40 GHz. The amplifier provides 18.5 dB of gain, +27 dBm Output IP3, and +22 dBm of output power at 1 dB gain compression, while requiring 280 mA from a +5V supply. Ideal as a driver amplifier for microwave radio applications, or as an LO driver for mixers operating between 18 and 40 GHz, the HMC635LC4 is capable of providing up to +23.5 dBm of saturated output power at 15% PAE. The amplifier's I/Os are DC blocked and internally matched to 50 Ohms making it ideal for integration into Multi-Chip-Modules (MCMs).

Electrical Specifications

$$T_A = +25^\circ \text{C}, V_{dd} = V_{dd1}, 2, 3, 4 = +5\text{V}, I_{dd} = I_{dd1} + I_{dd2} + I_{dd3} + I_{dd4} = 280\text{mA} \text{ [1]}$$

Parameter	Min.	Typ.	Max.	Min.	Typ.	Max.	Units	
Frequency Range	18 - 36		36 - 40					GHz
Gain [2]	15	18.5		15	17.5		dB	
Gain Variation Over Temperature		0.045	0.06		0.045	0.06	dB/ °C	
Input Return Loss		13			7		dB	
Output Return Loss		10			7		dB	
Output Power for 1 dB Compression (P1dB) [2]	19	22		16	21		dBm	
Saturated Output Power (P _{sat}) [2]		23.5			21.5		dBm	
Output Third Order Intercept (IP3)	22	27		21	26		dBm	
Noise Figure [2]		7			7		dB	
Total Supply Current (I _{dd1} + I _{dd2} + I _{dd3} + I _{dd4})		280			280		mA	

[1] Adjust V_{gg1} = V_{gg2} between -2 to 0V to achieve I_{dd} = 280 mA Typical.

[2] Board loss subtracted out for gain, power and noise figure measurements.



GaAs PHEMT MMIC DRIVER AMPLIFIER, 18 - 40 GHz

Broadband Gain & Return Loss [1]

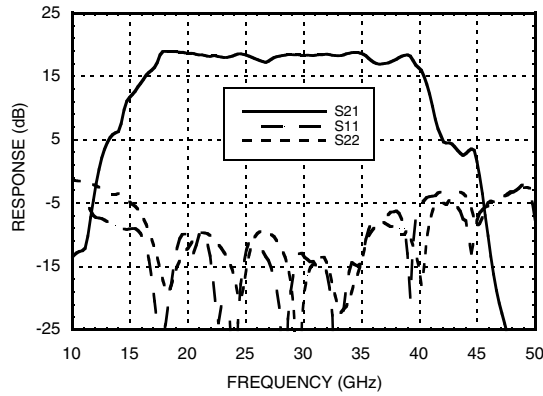

Gain vs. Temperature [1]

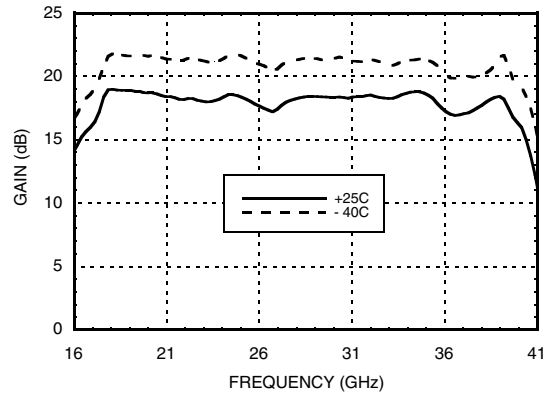

Input Return Loss vs. Temperature

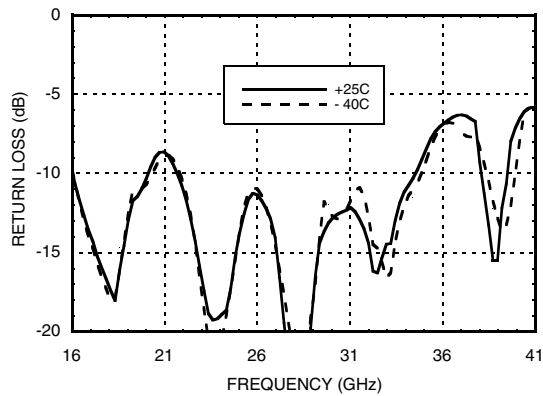

Output Return Loss vs. Temperature

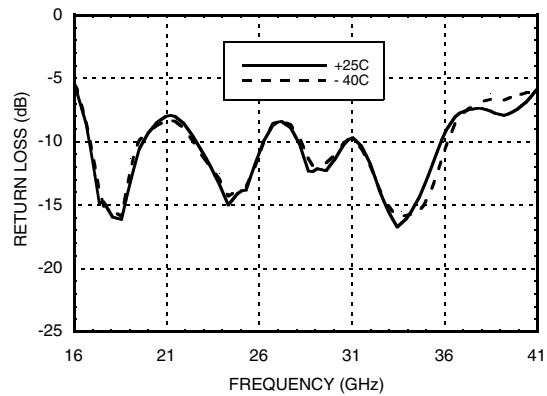

P1dB vs. Temperature [1]

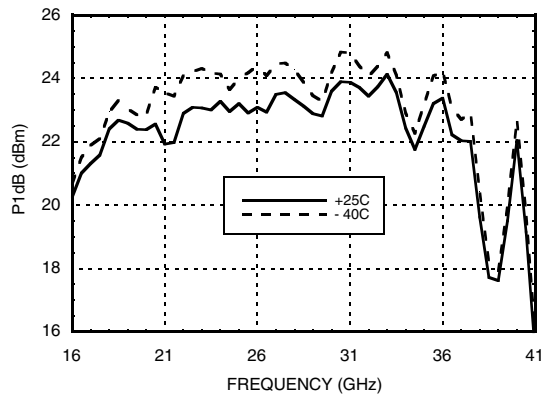

Psat vs. Temperature [1]

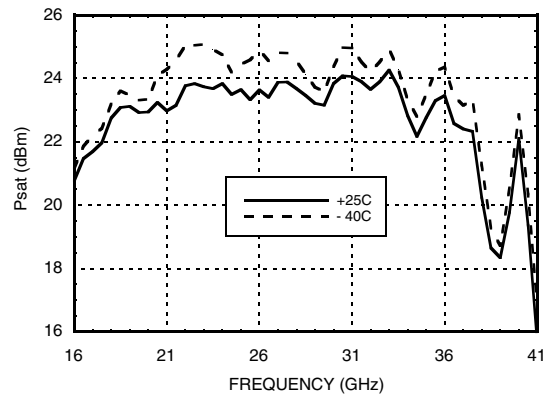

[1] Board loss subtracted out for gain, power and noise figure measurements.



**GaAs PHEMT MMIC DRIVER
AMPLIFIER, 18 - 40 GHz**

AMPLIFIERS - DRIVER & GAIN BLOCK - SMT

Power Compression @ 30 GHz [1]

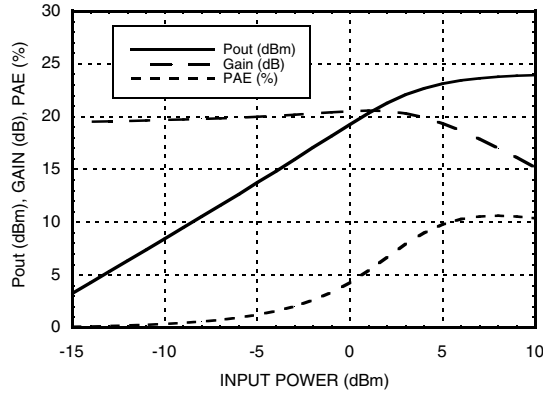

Power Compression @ 40 GHz [1]

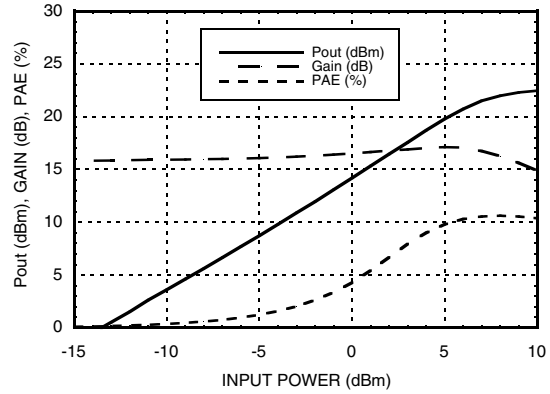

Output IP3 vs. Temperature

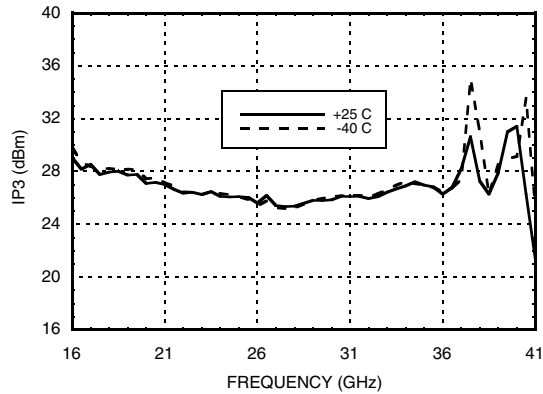

Noise Figure vs. Temperature [1]

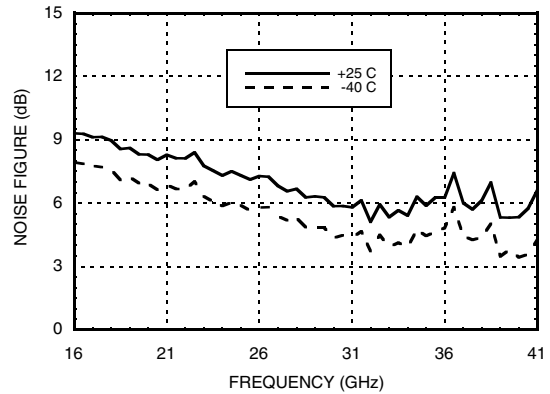

**Gain & Power vs.
Supply Voltage @ 30 GHz [1]**

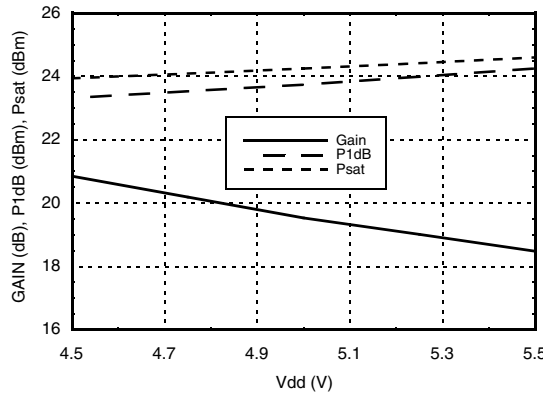

Reverse Isolation vs. Temperature

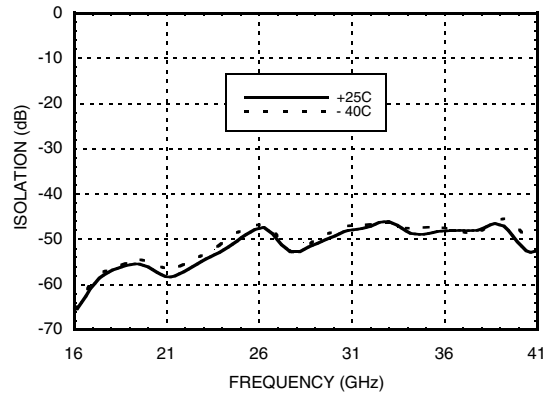

[1] Board loss subtracted out for gain, power and noise figure measurements.



GaAs PHEMT MMIC DRIVER AMPLIFIER, 18 - 40 GHz

Absolute Maximum Ratings

Drain Bias Voltage (Vdd1, 2, 3, 4)	+5.5V
Gate Bias Voltage (Vgg1, Vgg2)	-3 to 0V
RF Input Power (RFIN)(Vdd = +5 Vdc)	15 dBm
Channel Temperature	175 °C
Continuous Pdiss (T= 70 °C) (derate 15.1 mW/°C above 70 °C)	1.575 W
Thermal Resistance (channel to package base)	66.4 °C/W
Storage Temperature	-65 to +150 °C
Operating Temperature	-55 to +70 °C

Typical Supply Current vs. Vdd

Vdd (V)	Idd (mA)
4.5	277
5.0	280
5.5	286

Note: Amplifier will operate over full voltage ranges shown above



**ELECTROSTATIC SENSITIVE DEVICE
OBSERVE HANDLING PRECAUTIONS**

Outline Drawing

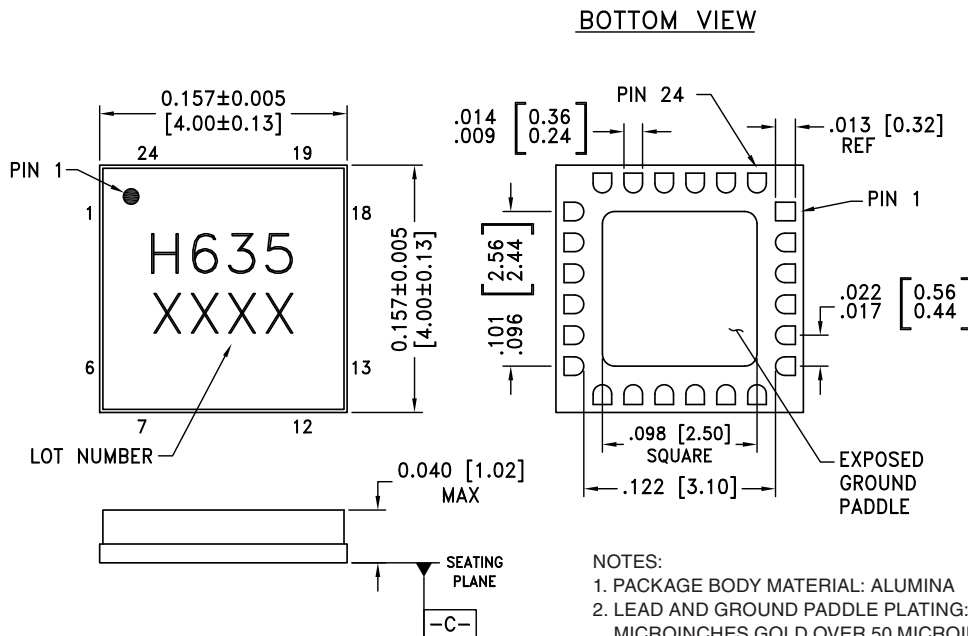

NOTES:

1. PACKAGE BODY MATERIAL: ALUMINA
2. LEAD AND GROUND PADDLE PLATING: 30-80 MICROINCHES GOLD OVER 50 MICROINCHES MINIMUM NICKEL.
3. DIMENSIONS ARE IN INCHES [MILLIMETERS].
4. LEAD SPACING TOLERANCE IS NON-CUMULATIVE.
5. PACKAGE WARP SHALL NOT EXCEED 0.05mm DATUM -C-
6. ALL GROUND LEADS AND GROUND PADDLE MUST BE SOLDERED TO PCB RF GROUND.

Package Information

Part Number	Package Body Material	Lead Finish	MSL Rating	Package Marking ^[2]
HMC635LC4	Alumina, White	Gold over Nickel	MSL3 ^[1]	H635 XXXX

[1] Max peak reflow temperature of 260 °C

[2] 4-Digit lot number XXXX

Information furnished by Analog Devices is believed to be accurate and reliable. However, no responsibility is assumed by Analog Devices for its use, nor for any infringements of patents or other rights of third parties that may result from its use. Specifications subject to change without notice. No license is granted by implication or otherwise under any patent or patent rights of Analog Devices. Trademarks and registered trademarks are the property of their respective owners.

For price, delivery, and to place orders: Analog Devices, Inc., One Technology Way, P.O. Box 9106, Norwood, MA 02062-9106
Phone: 781-329-4700 • Order online at www.analog.com
Application Support: Phone: 1-800-ANALOG-D



GaAs PHEMT MMIC DRIVER AMPLIFIER, 18 - 40 GHz

Pin Descriptions

Pin Number	Function	Description	Interface Schematic
1, 2, 4 - 8, 10, 12 - 15, 17 - 19, 24, Ground Paddle	GND	These pins and package bottom must be connected to RF/DC ground	
3	RFIN	This pad is AC coupled and matched to 50 Ohms.	
16	RFOUT	This pad is AC coupled and matched to 50 Ohms.	
9, 11	Vgg1, Vgg2	Gate control for amplifier, please follow "MMIC Amplifier Biasing Procedure" application note. See assembly diagram for required external components.	
20 - 23	Vdd4 - Vdd1	Power Supply Voltage for the amplifier. See assembly diagram for required external components.	

Application Circuit

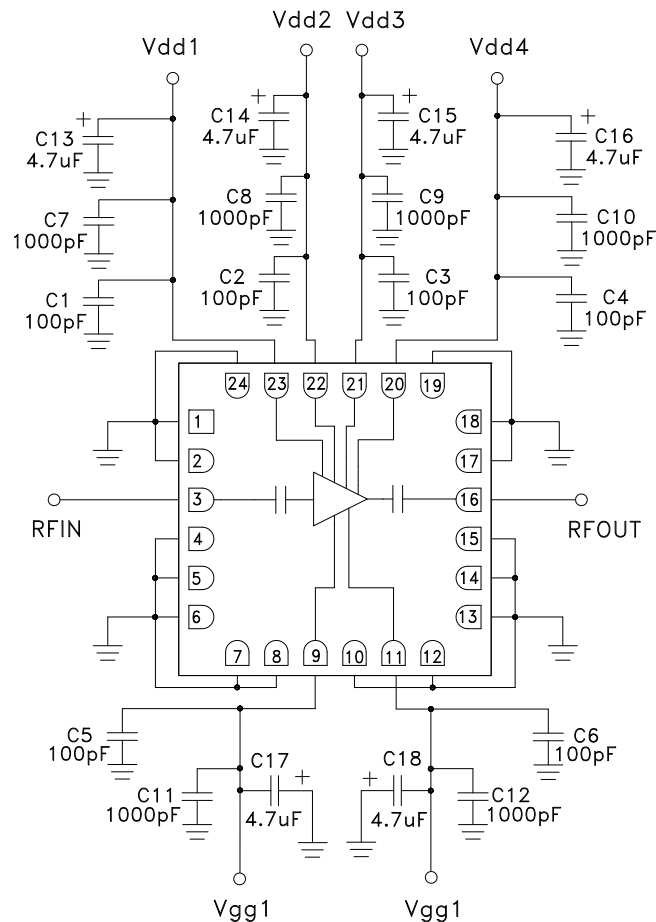

Information furnished by Analog Devices is believed to be accurate and reliable. However, no responsibility is assumed by Analog Devices for its use, nor for any infringements of patents or other rights of third parties that may result from its use. Specifications subject to change without notice. No license is granted by implication or otherwise under any patent or patent rights of Analog Devices. Trademarks and registered trademarks are the property of their respective owners.

For price, delivery, and to place orders: Analog Devices, Inc., One Technology Way, P.O. Box 9106, Norwood, MA 02062-9106 Phone: 781-329-4700 • Order online at www.analog.com Application Support: Phone: 1-800-ANALOG-D

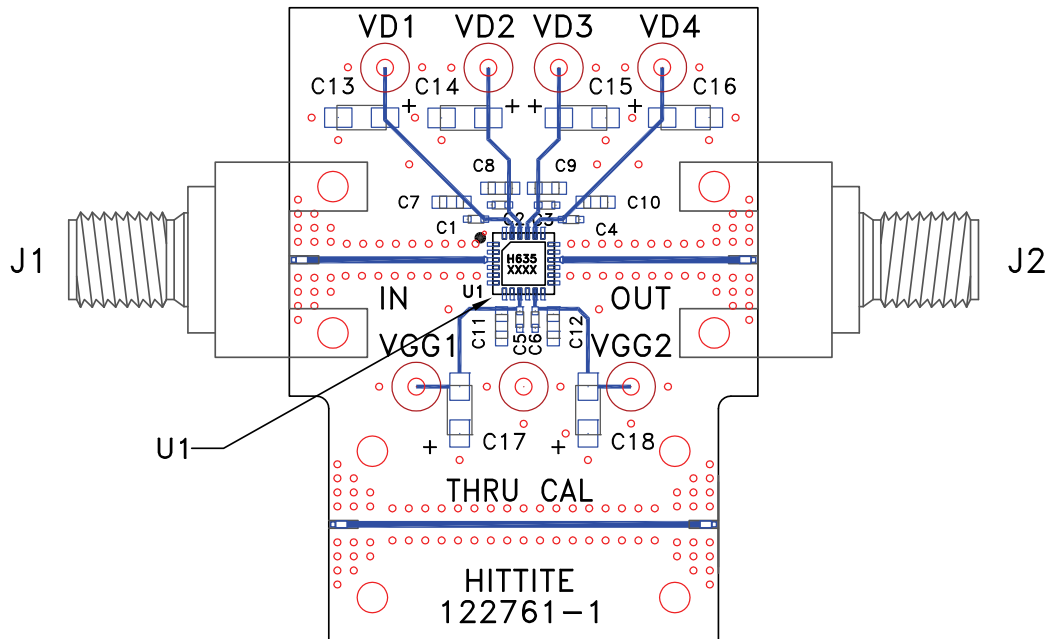
**GaAs PHEMT MMIC DRIVER
AMPLIFIER, 18 - 40 GHz**
Evaluation PCB

List of Materials for Evaluation 122763 [1]

Item	Description
J1 - J2	2.92 mm PC Mount K-Connector
VD1 - VD4, VGG1, VGG2	DC Pin
C1 - C6	100 pF Capacitor, 0402 Pkg.
C7 - C12	1000 pF Capacitor, 0603 Pkg.
C13 - C18	4.7 μ F Capacitor, Tantalum, Case A
U1	HMC635LC4 Driver Amplifier
PCB [2]	122761 Evaluation PCB [3]

[1] Reference this number when ordering complete evaluation PCB

[2] Circuit Board Material: Rogers 4350 or Arlon 25FR

[3] Due to the very high frequency operation of this product a custom LC4 PCB footprint and solder stencil are required for this design. Performance shown in this data sheet was produced using this custom footprint. **DO NOT USE** Hittite's standard LC4 footprint. Please contact Applications for details.

The circuit board used in the application should use RF circuit design techniques. Signal lines should have 50 Ohm impedance while the package ground leads and exposed paddle should be connected directly to the ground plane similar to that shown. A sufficient number of via holes should be used to connect the top and bottom ground planes. The evaluation board should be mounted to an appropriate heat sink. The evaluation circuit board shown is available from Hittite upon request.