



Power MOSFET

PRODUCT SUMMARY	
V _{DS} (V) at T _J max.	560
R _{DS(on)} (Ω)	V _{GS} = 10 V 0.38
Q _g (Max.) (nC)	68
Q _{gs} (nC)	17.6
Q _{gd} (nC)	21.8
Configuration	Single

FEATURES

- Low Figure-of-Merit R_{on} x Q_g
- 100 % Avalanche Tested
- Gate Charge Improved
- T_{rr}/Q_{rr} Improved
- Compliant to RoHS Directive 2002/95/EC



RoHS* COMPLIANT

Note

* Pb containing terminations are not RoHS compliant, exemptions may apply

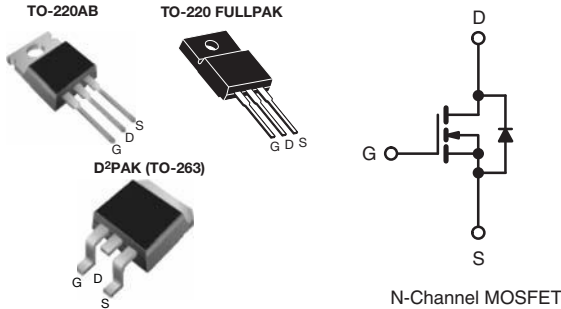

ORDERING INFORMATION			
Package	TO-220AB	D ² PAK (TO-263)	TO-220 FULLPAK
	SiHP16N50C-E3	SiHB16N50C-E3	SiHF16N50C-E3
Lead (Pb)-free	-	SiHB16N50CTR-E3	-
	-	SiHB16N50CTL-E3	-

ABSOLUTE MAXIMUM RATINGS (T _C = 25 °C, unless otherwise noted)				
PARAMETER		SYMBOL	LIMIT	UNIT
Drain-Source Voltage		V _{DS}	500	V
Gate-Source Voltage		V _{GS}	± 30	
Continuous Drain Current (T _J = 150 °C) ^a	V _{GS} at 10 V	T _C = 25 °C	16	A
		T _C = 100 °C	10	
Pulsed Drain Current ^c		I _{DM}	40	
Linear Derating Factor			2	W/°C
Single Pulse Avalanche Energy ^b		E _{AS}	320	mJ
Maximum Power Dissipation	TO220-AB, D ² PAK (TO-263)	P _D	250	W
	TO-220 FULLPAK		38	
Operating Junction and Storage Temperature Range		T _J , T _{stg}	- 55 to + 150	°C
Soldering Recommendations (Peak Temperature) ^d		for 10 s	300	

Notes

- Limited by maximum junction temperature.
- V_{DD} = 50 V, starting T_J = 25 °C, L = 2.5 mH, R_g = 25 Ω, I_{AS} = 16 A.
- Repetitive rating; pulse width limited by maximum junction temperature.
- 1.6 mm from case.



THERMAL RESISTANCE RATINGS				
PARAMETER	SYMBOL	TO220-AB D ² PAK (TO-263)	TO-220 FULLPAK	UNIT
Maximum Junction-to-Ambient	R _{thJA}	62	65	°C/W
Maximum Junction-to-Case (Drain)	R _{thJC}	0.5	3.3	
Junction-to-Ambient (PCB mount) ^a	R _{thJA}	40	-	

Note

a. When mounted on 1" square PCB (FR-4 or G-10 material).

SPECIFICATIONS (T _J = 25 °C, unless otherwise noted)						
PARAMETER	SYMBOL	TEST CONDITIONS	MIN.	TYP.	MAX.	UNIT
Static						
Drain-Source Breakdown Voltage	V _{DS}	V _{GS} = 0 V, I _D = 250 μA	500	-	-	V
V _{DS} Temperature Coefficient	ΔV _{DS} /T _J	Reference to 25 °C, I _D = 1 mA	-	0.6	-	V/°C
Gate-Source Threshold Voltage (N)	V _{GS(th)}	V _{DS} = V _{GS} , I _D = 250 μA	3.0	-	5.0	V
Gate-Source Leakage	I _{GSS}	V _{GS} = ± 30 V	-	-	± 100	nA
Zero Gate Voltage Drain Current	I _{DSS}	V _{DS} = 500 V, V _{GS} = 0 V	-	-	50	μA
		V _{DS} = 400 V, V _{GS} = 0 V, T _J = 125 °C	-	-	250	
Drain-Source On-State Resistance	R _{DS(on)}	V _{GS} = 10 V, I _D = 8 A	-	0.31	0.38	Ω
Forward Transconductance ^a	g _{fs}	V _{DS} = 50 V, I _D = 3 A	-	3	-	S
Dynamic						
Input Capacitance	C _{iss}	V _{GS} = 0 V, V _{DS} = 25 V, f = 1.0 MHz	-	1900	-	pF
Output Capacitance	C _{oss}		-	230	-	
Reverse Transfer Capacitance	C _{rss}		-	24	-	
Total Gate Charge	Q _g	V _{GS} = 10 V, I _D = 16 A, V _{DS} = 400 V	-	45	68	nC
Gate-Source Charge	Q _{gs}		-	18	-	
Gate-Drain Charge	Q _{gd}		-	22	-	
Turn-On Delay Time	t _{d(on)}	V _{DD} = 250 V, I _D = 16 A, R _g = 9.1 Ω, V _{GS} = 10 V	-	27	-	ns
Rise Time	t _r		-	156	-	
Turn-Off Delay Time	t _{d(off)}		-	29	-	
Fall Time	t _f		-	31	-	
Gate Input Resistance	R _g	f = 1 MHz, open drain	-	1.6	-	Ω
Drain-Source Body Diode Characteristics						
Continuous Source-Drain Diode Current	I _S	MOSFET symbol showing the integral reverse p - n junction diode 	-	-	16	A
Pulsed Diode Forward Current	I _{SM}		-	-	30	
Body Diode Voltage	V _{SD}	T _J = 25 °C, I _S = 10 A, V _{GS} = 0 V	-	-	1.8	V
Body Diode Reverse Recovery Time	t _{rr}	T _J = 25 °C, I _F = I _S , dI/dt = 100 A/μs, V _R = 20 V	-	555	-	ns
Body Diode Reverse Recovery Charge	Q _{rr}		-	5.5	-	μC
Body Diode Reverse Recovery Current	I _{RRM}		-	18	-	A

Note

- The information shown here is a preliminary product proposal, not a commercial product data sheet. Vishay Siliconix is not committed to produce this or any similar product. This information should not be used for design purposes, nor construed as an offer to furnish or sell such products.



TYPICAL CHARACTERISTICS (25 °C, unless otherwise noted)

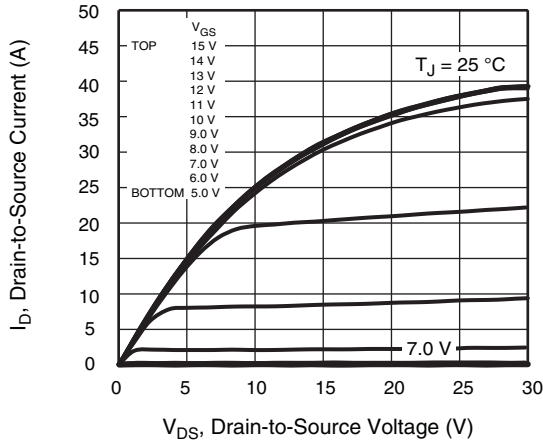

Fig. 1 - Typical Output Characteristics (TO-220)

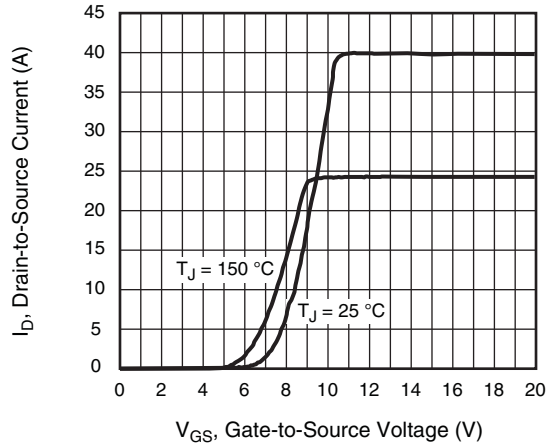

Fig. 3 - Typical Transfer Characteristics

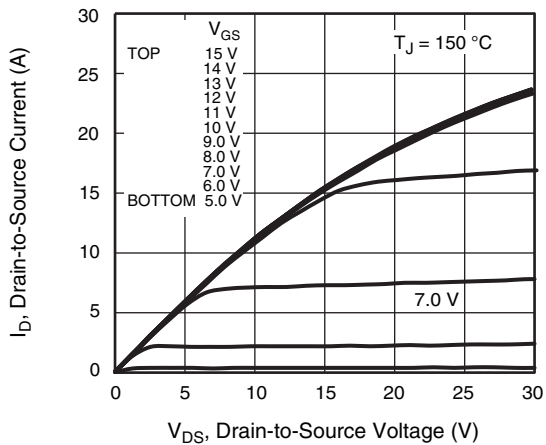

Fig. 2 - Typical Output Characteristics (TO-220)

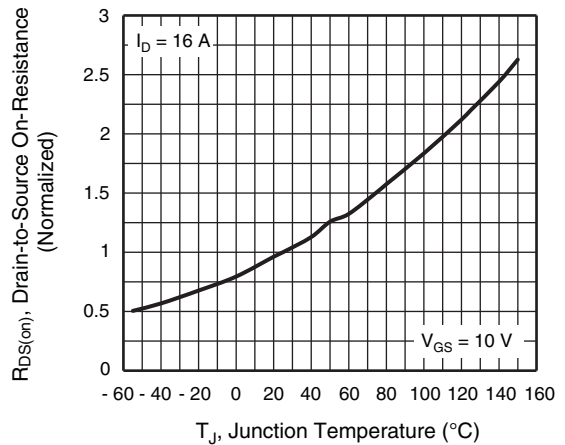

Fig. 4 - Normalized On-Resistance vs. Temperature

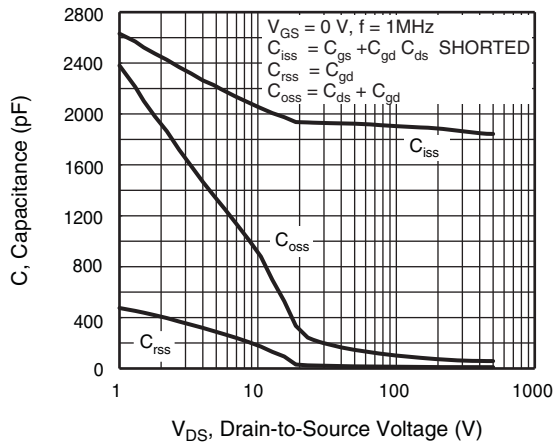

Fig. 5 - Typical Capacitance vs. Drain-to-Source Voltage

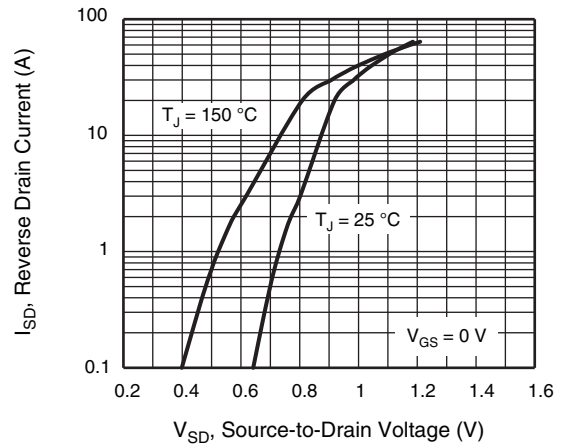

Fig. 7 - Typical Source-Drain Diode Forward Voltage

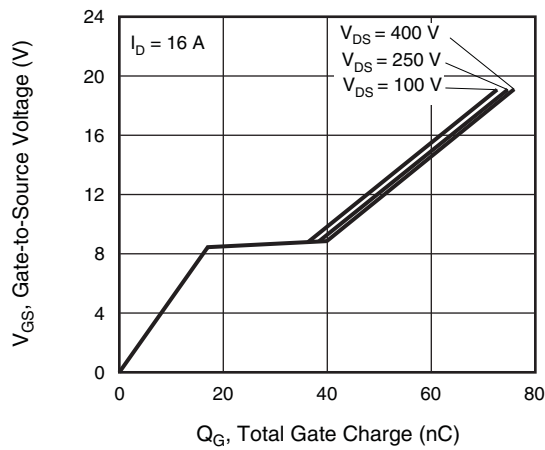

Fig. 6 - Typical Gate Charge vs. Gate-to-Source Voltage

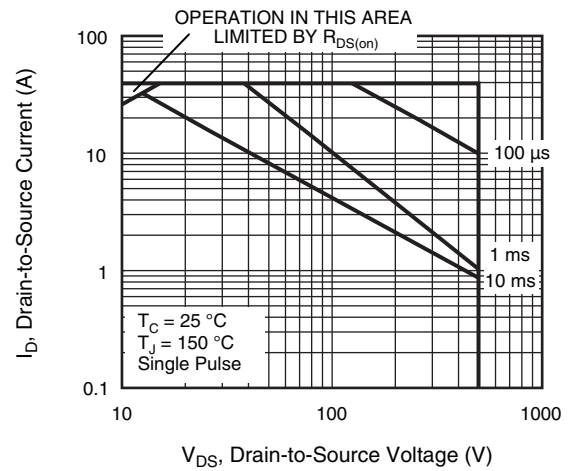

Fig. 8 - Maximum Safe Operating Area (TO-220AB, D²PAK)

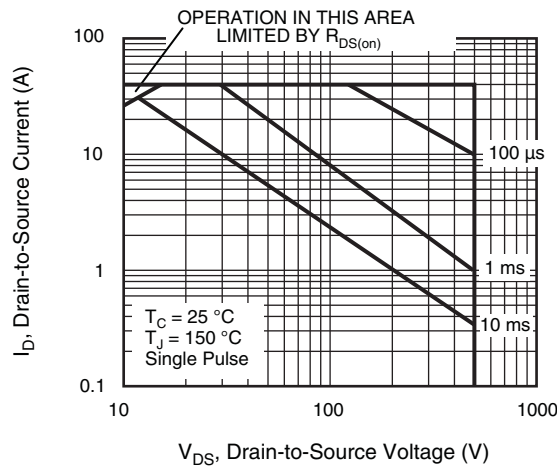

Fig. 9 - Maximum Safe Operating Area (TO-220 FULLPAK)

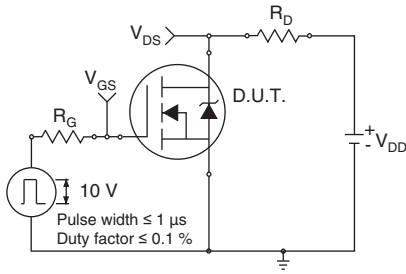

Fig. 10a - Switching Time Test Circuit

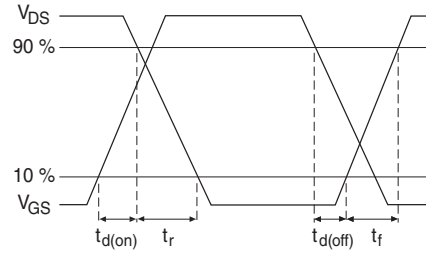

Fig. 10b - Switching Time Waveforms

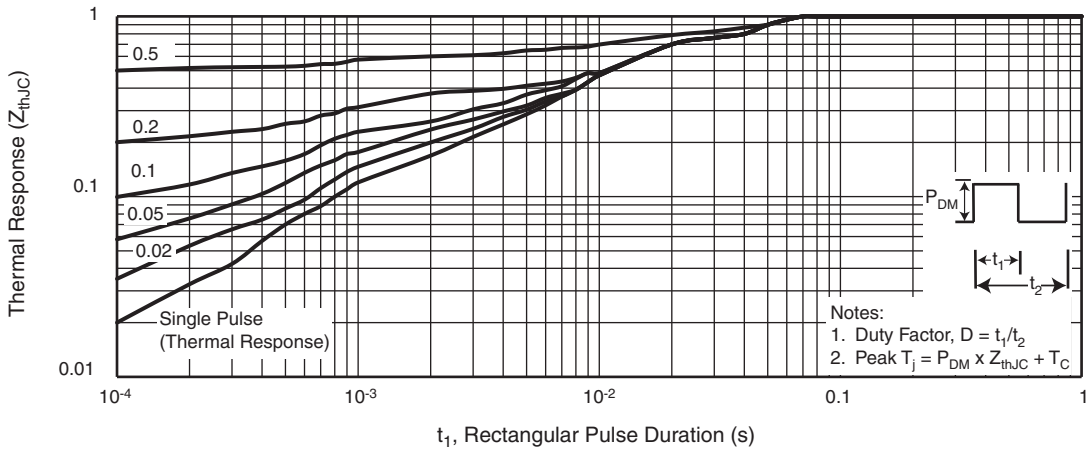

Fig. 11 - Maximum Effective Transient Thermal Impedance, Junction-to-Case (TO-220AB, D²PAK)

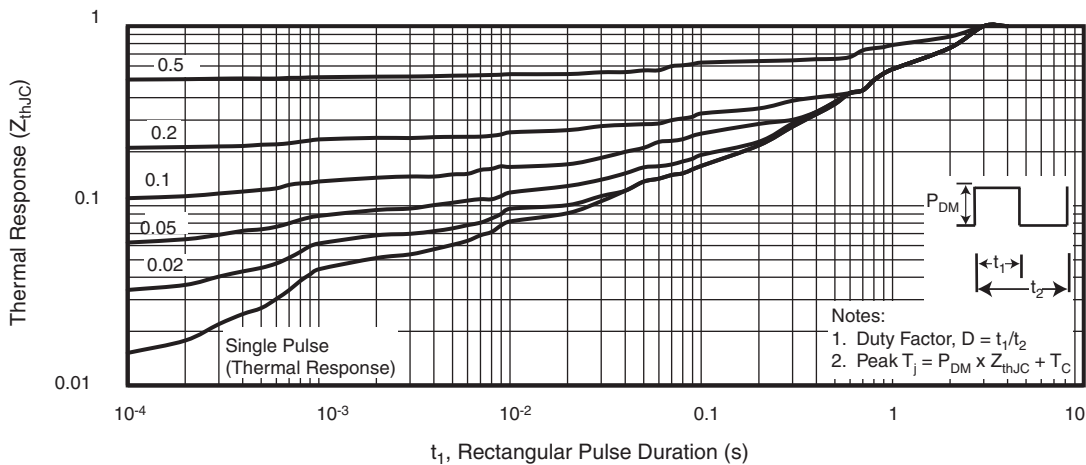

Fig. 12 - Maximum Effective Transient Thermal Impedance, Junction-to-Case (TO-220 FULLPAK)

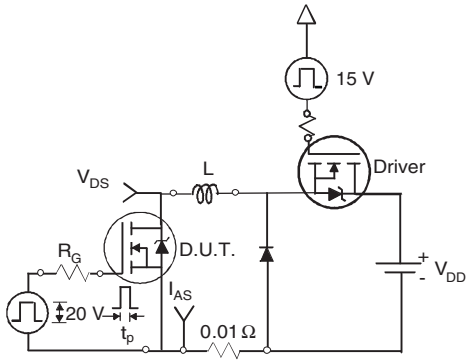

Fig. 13a - Unclamped Inductive Test Circuit

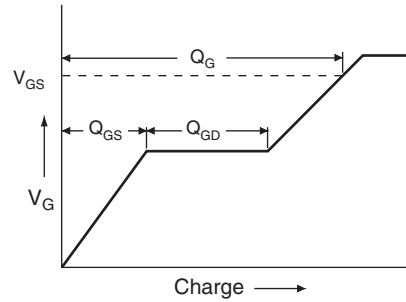

Fig. 14a - Basic Gate Charge Waveform

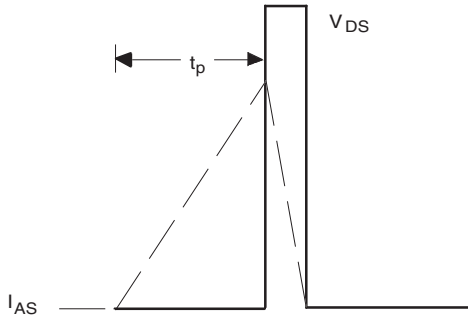

Fig. 13b - Unclamped Inductive Waveforms

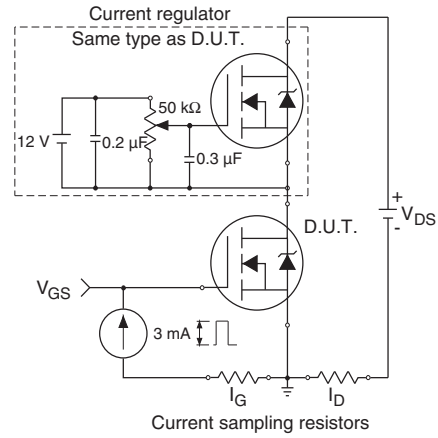
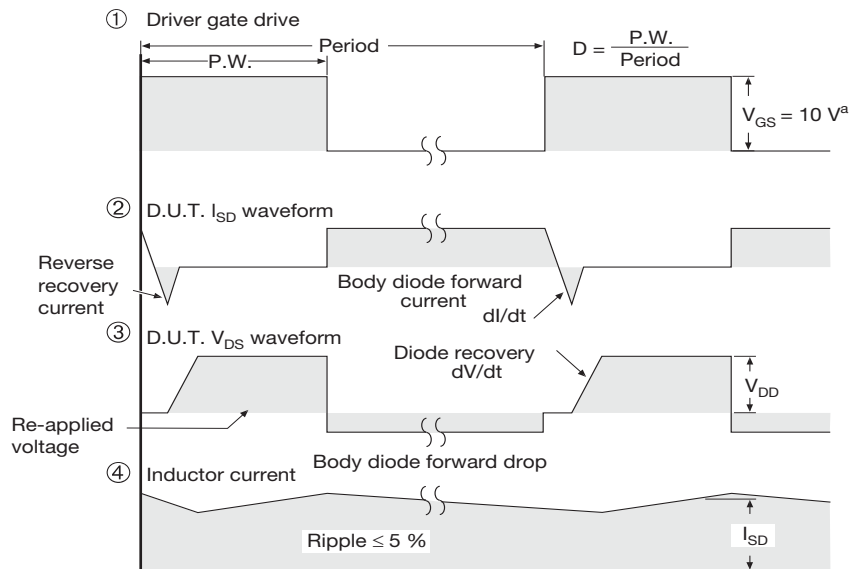
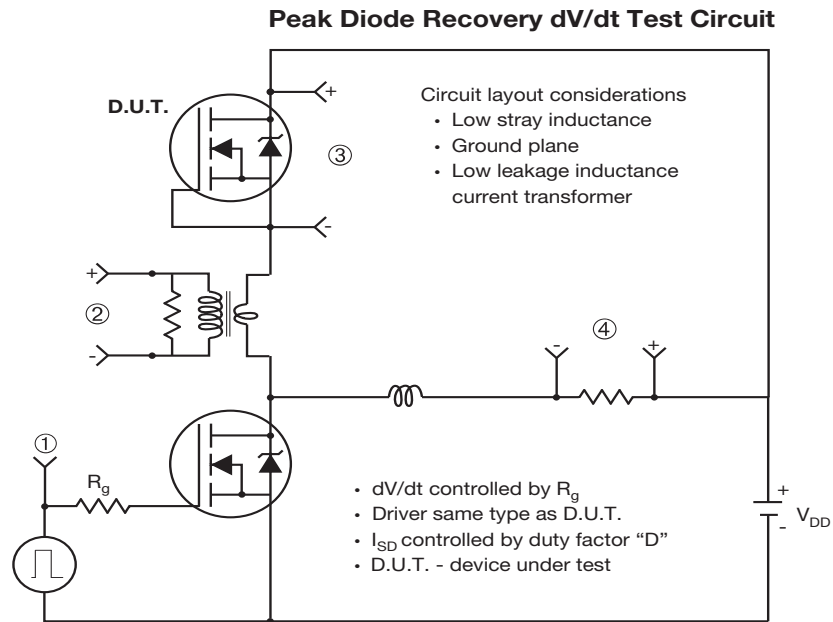

Fig. 14b - Gate Charge Test Circuit



Note

a. $V_{GS} = 5 V$ for logic level devices

Fig. 15 - For N-Channel

Vishay Siliconix maintains worldwide manufacturing capability. Products may be manufactured at one of several qualified locations. Reliability data for Silicon Technology and Package Reliability represent a composite of all qualified locations. For related documents such as package/tape drawings, part marking, and reliability data, see www.vishay.com/ppg?91401.

TO-220-1



DIM.	MILLIMETERS		INCHES	
	MIN.	MAX.	MIN.	MAX.
A	4.24	4.65	0.167	0.183
b	0.69	1.02	0.027	0.040
b(1)	1.14	1.78	0.045	0.070
c	0.36	0.61	0.014	0.024
D	14.33	15.85	0.564	0.624
E	9.96	10.52	0.392	0.414
e	2.41	2.67	0.095	0.105
e(1)	4.88	5.28	0.192	0.208
F	1.14	1.40	0.045	0.055
H(1)	6.10	6.71	0.240	0.264
J(1)	2.41	2.92	0.095	0.115
L	13.36	14.40	0.526	0.567
L(1)	3.33	4.04	0.131	0.159
Ø P	3.53	3.94	0.139	0.155
Q	2.54	3.00	0.100	0.118

ECN: X15-0364-Rev. C, 14-Dec-15
DWG: 6031

Note

- M* = 0.052 inches to 0.064 inches (dimension including protrusion), heatsink hole for HVM





Disclaimer

ALL PRODUCT, PRODUCT SPECIFICATIONS AND DATA ARE SUBJECT TO CHANGE WITHOUT NOTICE TO IMPROVE RELIABILITY, FUNCTION OR DESIGN OR OTHERWISE.

Vishay Intertechnology, Inc., its affiliates, agents, and employees, and all persons acting on its or their behalf (collectively, "Vishay"), disclaim any and all liability for any errors, inaccuracies or incompleteness contained in any datasheet or in any other disclosure relating to any product.

Vishay makes no warranty, representation or guarantee regarding the suitability of the products for any particular purpose or the continuing production of any product. To the maximum extent permitted by applicable law, Vishay disclaims (i) any and all liability arising out of the application or use of any product, (ii) any and all liability, including without limitation special, consequential or incidental damages, and (iii) any and all implied warranties, including warranties of fitness for particular purpose, non-infringement and merchantability.

Statements regarding the suitability of products for certain types of applications are based on Vishay's knowledge of typical requirements that are often placed on Vishay products in generic applications. Such statements are not binding statements about the suitability of products for a particular application. It is the customer's responsibility to validate that a particular product with the properties described in the product specification is suitable for use in a particular application. Parameters provided in datasheets and / or specifications may vary in different applications and performance may vary over time. All operating parameters, including typical parameters, must be validated for each customer application by the customer's technical experts. Product specifications do not expand or otherwise modify Vishay's terms and conditions of purchase, including but not limited to the warranty expressed therein.

Except as expressly indicated in writing, Vishay products are not designed for use in medical, life-saving, or life-sustaining applications or for any other application in which the failure of the Vishay product could result in personal injury or death. Customers using or selling Vishay products not expressly indicated for use in such applications do so at their own risk. Please contact authorized Vishay personnel to obtain written terms and conditions regarding products designed for such applications.

No license, express or implied, by estoppel or otherwise, to any intellectual property rights is granted by this document or by any conduct of Vishay. Product names and markings noted herein may be trademarks of their respective owners.