



**GLT240128**  
**Technical Manual**

**Revision: 1.2**

# Contents

<b>Contents</b>	<b>ii</b>
<b>1 Getting Started</b>	<b>1</b>
1.1 Display Options Available . . . . .	1
1.2 Accessories . . . . .	2
1.3 Features . . . . .	3
1.4 Connecting to a PC . . . . .	4
1.4.1 Connection for Non-USB Modules . . . . .	4
1.4.2 Connection for USB Modules . . . . .	5
1.5 Installing the Software . . . . .	5
1.5.1 MOGD# . . . . .	5
<b>2 Hardware Information</b>	<b>6</b>
2.1 Communication Connectors . . . . .	8
2.1.1 Power/Data Connector for Non-USB modules only . . . . .	8
2.1.2 USB Connector for USB modules only . . . . .	9
2.2 Touchpad Interface Connector . . . . .	10
2.3 DB-9 Connector for Non-USB modules only . . . . .	10
2.4 Power Through DB-9 Jumper . . . . .	11
2.5 Optional USB Header for USB modules only . . . . .	12
2.6 Protocol Select Jumpers . . . . .	12
2.7 Filesystem Lock Jumper . . . . .	13
2.8 Manual Override . . . . .	14
<b>3 Troubleshooting</b>	<b>15</b>
3.1 The display does not turn on when power is applied. . . . .	15
3.2 The display module is not communicating. . . . .	15
3.3 The display module is communicating, however text cannot be displayed. . . . .	16
3.4 There is a problem uploading fonts or bitmaps. . . . .	16
<b>4 Communications</b>	<b>16</b>
4.1 Introduction . . . . .	16
4.1.1 I <sup>2</sup> C Communication Summary . . . . .	16
4.1.2 I <sup>2</sup> C Transaction Example . . . . .	17
4.1.3 Serial Communication . . . . .	18
4.1.4 USB Communication . . . . .	18
4.2 Turn Flow Control On . . . . .	18
4.3 Turn Flow Control Off . . . . .	19
4.4 Changing the I <sup>2</sup> C Slave Address . . . . .	19
4.5 Changing the Baud Rate . . . . .	20
4.6 Setting a Non-Standard Baud Rate . . . . .	21

<b>5</b>	<b>Fonts</b>	<b>22</b>
5.1	Introduction . . . . .	22
5.1.1	Font File Format . . . . .	22
5.1.2	Creating a Font . . . . .	22
5.2	Uploading a Font File . . . . .	24
5.3	Setting the Current Font . . . . .	24
5.4	Font Metrics . . . . .	25
5.5	Set Box Space Mode . . . . .	26
<b>6</b>	<b>Text</b>	<b>26</b>
6.1	Introduction . . . . .	26
6.1.1	Character Set . . . . .	26
6.1.2	Control Characters . . . . .	26
6.2	Move Cursor Home . . . . .	26
6.3	Setting the Cursor Position . . . . .	27
6.4	Setting the Cursor Coordinate . . . . .	27
6.5	Auto Scroll On . . . . .	27
6.6	Auto Scroll Off . . . . .	28
<b>7</b>	<b>Bitmaps</b>	<b>28</b>
7.1	Introduction . . . . .	28
7.2	Uploading a Bitmap File . . . . .	28
7.3	Drawing a Bitmap from Memory . . . . .	29
7.4	Drawing a Bitmap Directly . . . . .	30
<b>8</b>	<b>Bar Graphs and Drawing</b>	<b>30</b>
8.1	Introduction . . . . .	30
8.2	Set Drawing Color . . . . .	30
8.3	Draw Pixel . . . . .	31
8.4	Drawing a Line . . . . .	31
8.5	Continue a Line . . . . .	32
8.6	Draw a Rectangle . . . . .	32
8.7	Drawing a Solid Rectangle . . . . .	32
8.8	Initializing a Bar Graph . . . . .	33
8.9	Drawing a Bar Graph . . . . .	34
8.10	Initializing a Strip Chart . . . . .	34
8.11	Shifting a Strip Chart . . . . .	35
<b>9</b>	<b>Touchpad</b>	<b>36</b>
9.1	Introduction . . . . .	36
9.1.1	Region Mode . . . . .	36
9.1.2	Co-ordinate Mode . . . . .	36
9.2	Set Touch Region . . . . .	37
9.3	Delete Touch Region . . . . .	37
9.4	Delete All Touch Regions . . . . .	37
9.5	Set Touch Mode . . . . .	38
9.6	Set Region Reporting Mode . . . . .	38

9.7	Set Dragging Threshold . . . . .	39
9.8	Set Pressure Threshold . . . . .	39
9.9	Run Touchpad Calibration . . . . .	39
<b>10</b>	<b>Display Functions</b>	<b>40</b>
10.1	Introduction . . . . .	40
10.2	Clear Screen . . . . .	40
10.3	Display On . . . . .	40
10.4	Display Off . . . . .	41
10.5	Set Brightness . . . . .	41
10.6	Set and Save Brightness . . . . .	41
10.7	Set Contrast . . . . .	42
10.8	Set and Save Contrast . . . . .	42
<b>11</b>	<b>Filesystem</b>	<b>43</b>
11.1	Introduction . . . . .	43
11.1.1	File Upload Protocol . . . . .	43
11.1.2	XModem Upload Protocol . . . . .	45
11.2	Wipe Filesystem . . . . .	45
11.3	Deleting a File . . . . .	46
11.4	Get Filesystem Space . . . . .	46
11.5	Get Filesystem Directory . . . . .	48
11.6	Filesystem Upload . . . . .	48
11.7	Downloading a File . . . . .	48
11.8	Moving a File . . . . .	49
<b>12</b>	<b>Data Security</b>	<b>49</b>
12.1	Introduction . . . . .	49
12.2	Set Remember . . . . .	50
12.3	Data Lock . . . . .	50
12.4	Set and Save Data Lock . . . . .	52
12.5	Dump the Filesystem . . . . .	52
12.6	Write Customer Data . . . . .	52
12.7	Read Customer Data . . . . .	52
<b>13</b>	<b>Miscellaneous</b>	<b>53</b>
13.1	Introduction . . . . .	53
13.2	Read Version Number . . . . .	53
13.3	Read Module Type . . . . .	53
<b>14</b>	<b>Command Summary</b>	<b>55</b>
14.1	Communications . . . . .	55
14.2	Fonts . . . . .	55
14.3	Text . . . . .	55
14.4	Bitmaps . . . . .	56
14.5	Bar Graphs and Drawing . . . . .	56
14.6	Touchpad . . . . .	57

14.7 Display Functions . . . . .	57
14.8 Filesystem . . . . .	58
14.9 Data Security . . . . .	58
14.10Miscellaneous . . . . .	59
14.11Command By Number . . . . .	59
<b>15 Appendix</b>	<b>61</b>
15.1 Optical Characteristics . . . . .	61
15.2 Specifications . . . . .	61
15.2.1 Environmental . . . . .	61
15.2.2 Electrical . . . . .	62
15.2.3 Touch . . . . .	62
15.3 Physical Layout . . . . .	62
15.4 Ordering Information . . . . .	64
15.5 Definitions . . . . .	64
15.6 Contacting Matrix Orbital . . . . .	64
15.7 Revision History . . . . .	65

# 1 Getting Started

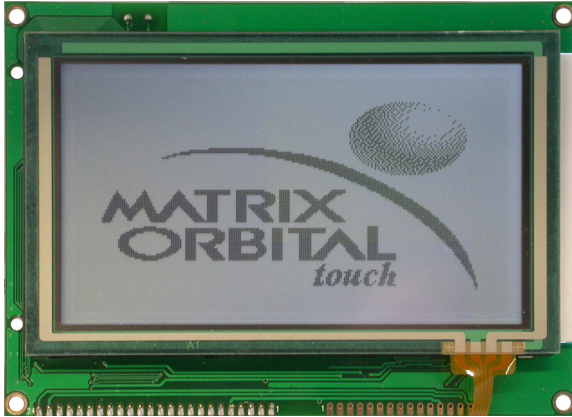

The GLT240128 is an intelligent graphic LCD display designed to decrease development time by providing an instant touch screen solution to any project. With the ability to communicate via serial RS-232 protocol at regular and TTL levels as well as USB and I<sup>2</sup>C, the versatile GLT240128 can be used with virtually any controller. The ease of use is further enhanced by an intuitive command structure to allow display settings such as backlight brightness, contrast and baud rate to be software controlled. Additionally, text and fonts may be uploaded to the display and stored in the on board memory. Finally, simple touch commands allow for the seamless integration of user control into the display environment.

## 1.1 Display Options Available

The GLT240128 comes in three backlight options, grey text on a white backlight, white text with a blue backlight, and standard grey text on a yellow-green backlight. Extended voltage options are also available to allow you to select the display which will best fit your project needs. Please see table 81 for ordering information.

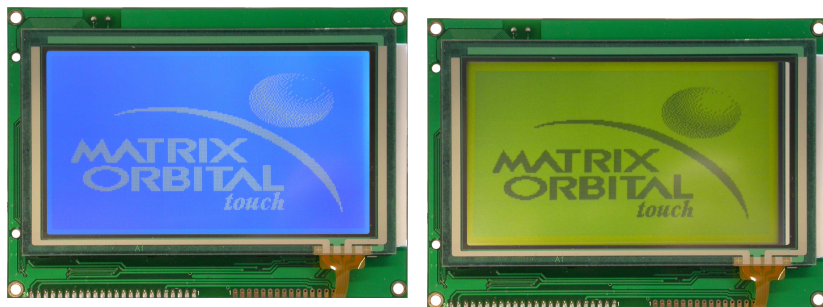

Figure 1: GLT240128 Options

## 1.2 Accessories

---

**NOTE** Matrix Orbital provides all the interface accessories needed to get your display up and running. You will find these accessories and others on our e-commerce website at <http://www.matrixorbital.com>. To contact a sales associate see Section 15.6 for contact information.

---



Figure 2: 5V Power Adapter



Figure 3: 12V Power Adaptor (-V/-VPT)



Figure 4: 3ft Mini-B USB Cable



Figure 5: Breadboard Cable

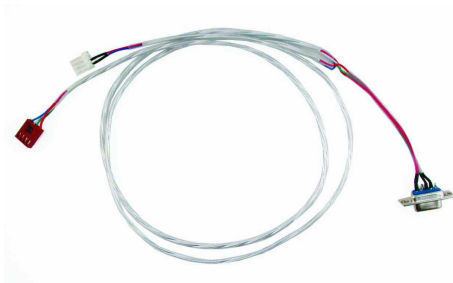

Figure 6: Communication & Power Cable

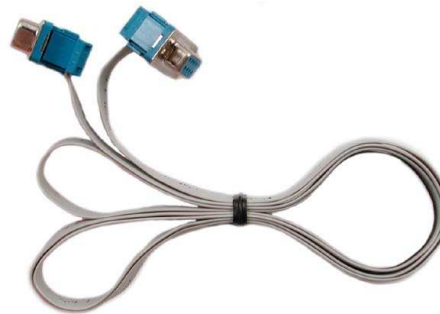

Figure 7: Serial Cable

### 1.3 Features

- 240 x 128 pixel graphics display
- Integrated Touchpad Overlay
- Selectable communication protocol, RS-232, TTL, and I<sup>2</sup>C for Non-USB models; USB only for USB models



- 128 byte buffered communication
- 16 KB flash memory for fonts and bitmaps
- Lightning fast communication speeds, up to 115 kbps for Serial and 100 kbps for I<sup>2</sup>C protocol
- \* Use of up to 127 modules on the same 2 wire I<sup>2</sup>C interface
- Display text using built in or user supplied fonts
- Software adjustable contrast and backlight brightness
- Default 19.2 kbps serial communication speed
- Extended voltage, and efficient power supply available

## 1.4 Connecting to a PC

The GLT240128 connects seamlessly to a PC and it is an excellent means of testing the functionality and uploading new fonts and bitmaps. For the Non-USB version, you will require a standard RS-232 9-pin serial cable such as the one pictured in Figure 7, as well as a modified 5V or 12V power adapter, depending on the voltage model, such as the ones pictured in Figures 2 and 3. For the USB model, of course, all you will need is a USB to mini USB cable such as the one in Figure 4.

### 1.4.1 Connection for Non-USB Modules

In order to connect your Non-USB display to a personal computer follow these easy instructions:

1. Plug the serial cable into the com port you wish to use.
2. Connect the appropriate modified power adapter to a power lead from your PC power supply (you will have to open your computer case).
3. Connect the serial cable to the DB-9 connector on the back of the display.
4. Connect the appropriate power adapter to the 4-pin connector on the back of the display.

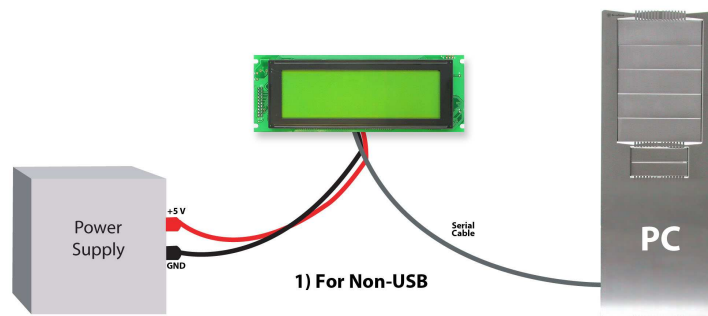

**WARNING** DO NOT use the standard floppy drive power connector on the Power/Data Connector, as this will not provide you with the correct voltage and will damage the display module.

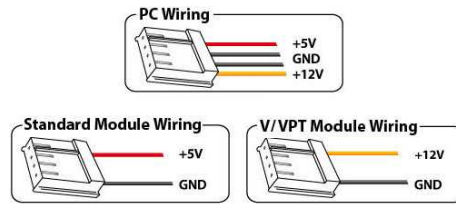
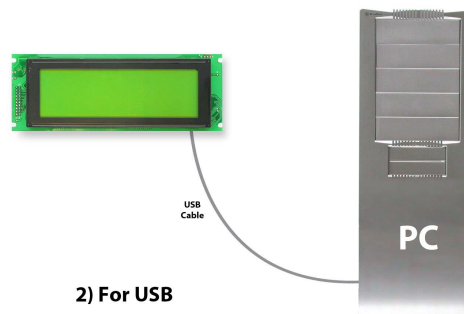

Figure 8: PC vs Matrix Orbital Display Module Wiring

## 1.4.2 Connection for USB Modules

In order to connect your USB display to a personal computer simply plug the mini-B USB cable, such as that shown in Figure 4 from the PC to the USB connector on the display.



## 1.5 Installing the Software

### 1.5.1 MOGD#

MOGD# is the latest updated version of MOGD and can be used to manage font and graphics downloads as well as exercise all of the features of our graphical displays. MOGD# provides a new user friendly interface as well as many feature enhancements.

To install MOGD# from the Matrix Orbital website, follow the following steps:

1. Go to the website location: [http://www.matrixorbital.ca/software/software\\_graphic/MOGDsharp/](http://www.matrixorbital.ca/software/software_graphic/MOGDsharp/)
2. Click on "Download Here"
3. Locate the file MogdSharp.zip on your desktop
4. Unzip MogdSharp.zip to a temporary directory using a program such as Winzip
5. Double click on "setup.exe"

6. Follow the instructions on the screen to complete the installation
7. MOGD# requires the .NET framework 2.0 and will download and install it automatically

After the installation is complete there will be a Matrix Orbital entry under "Start->Programs->Matrix Orbital" in the start menu. Click on the 'Mogd Sharp' entry to run the program.

Be sure to check the information selected in the configuration panel the first time MOGD# is run. Once this information is entered correctly the program can be used to control all functions of the graphic display.

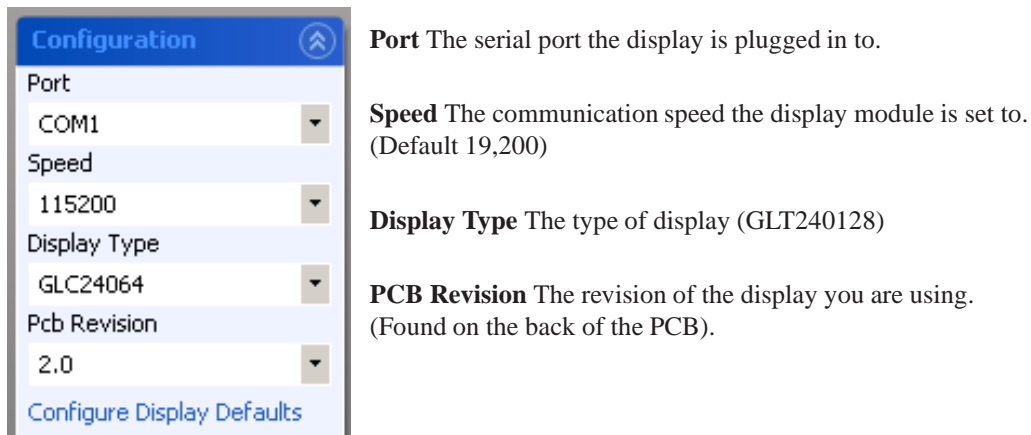
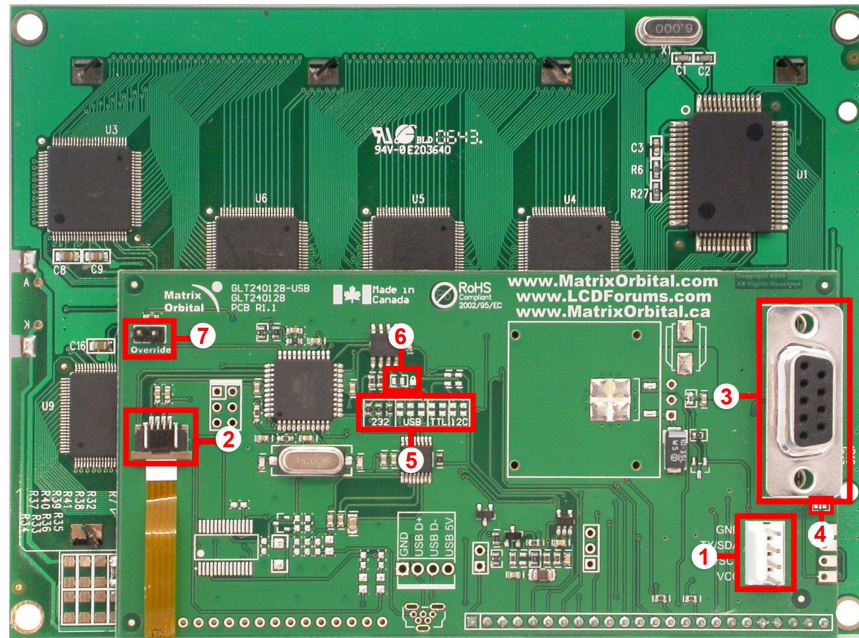

Figure 9: Mogd Sharp Settings

- Winzip is available as a free download from <http://www.winzip.com>

## 2 Hardware Information

Refer to the following diagram for this chapter:



- |                                   |                                  |
|-----------------------------------|----------------------------------|
| <b>1</b> Power/Data Connector     | <b>5</b> Protocol Select Jumpers |
| <b>2</b> Touchpad Header          | <b>6</b> Filesystem Lock Jumper  |
| <b>3</b> DB9 Connector            | <b>7</b> Manual Override Jumper  |
| <b>4</b> Power Through DB9 Jumper |                                  |

Figure 10: GLT240128 Non-USB

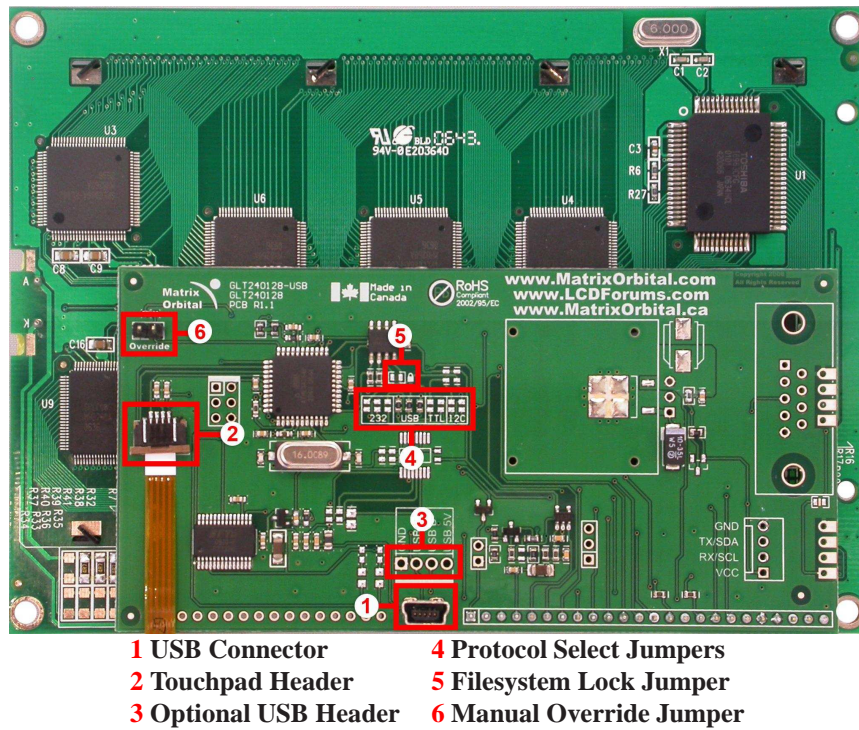

Figure 11: GLT240128 USB

## 2.1 Communication Connectors

### 2.1.1 Power/Data Connector for Non-USB modules only

The *Power/Data Connector* provides a standard connector for powering the display module. The GLT240128 requires five volts for the standard display module, between nine to fifteen for the wide voltage (V) model, and between nine to thirty-five volts for the wide voltage with efficient power supply module (VPT). The voltage is applied through pins one and four of the four pin *Power/Data Connector*. Pins two and three are reserved for serial transmission, using either the RS-232 or TTL protocol levels, depending on what has been selected by the *Protocol Select Jumpers*.



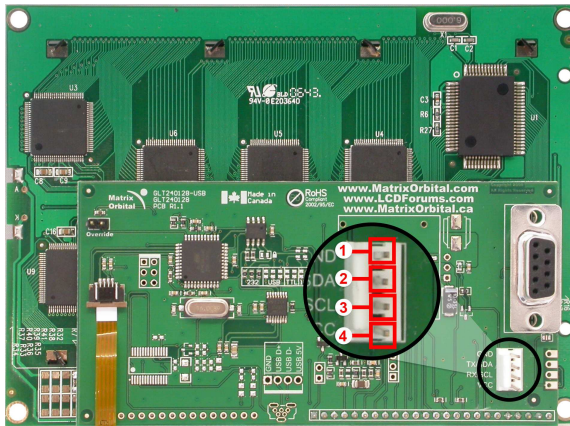

- Pin 1** GND
- Pin 2** Tx/SDA (I<sup>2</sup>C data)
- Pin 3** Rx/SCL (I<sup>2</sup>C clock)
- Pin 4** Vcc (see table 78 on page 62)

Figure 12: Power Connector and Pin-out

## 2.1.2 USB Connector for USB modules only

The *USB Connector* provides a standard connector for powering and communicating to the USB display module. As with the non-USB version, the GLT240128-USB requires five volts for the standard display module as per table 78.

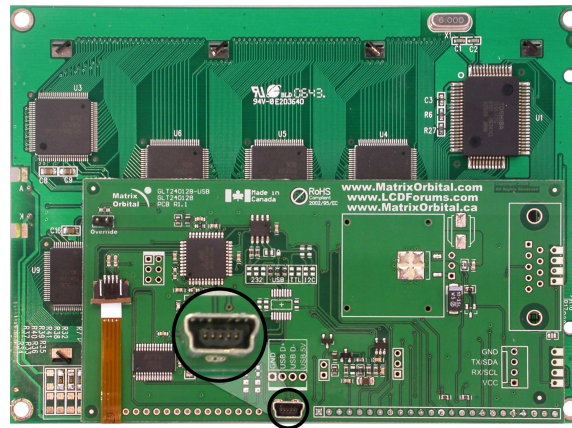

Figure 13: USB Connector for GLT240128

## 2.2 Touchpad Interface Connector

The GLT240128 provides a *Touchpad Interface Connector* which allows for the touchpad to be interfaced to the display. This connector should remain plugged in while the unit is in operation and should not be tampered with in any way.

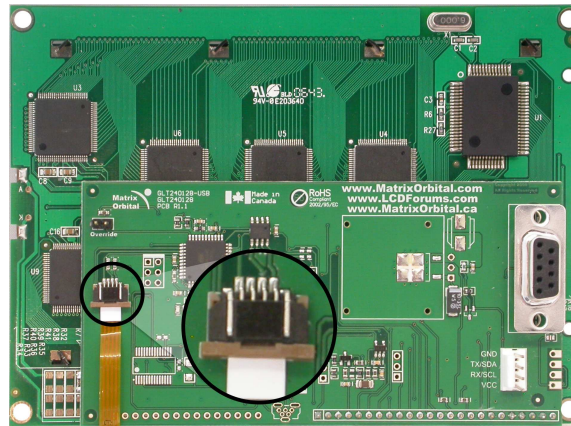
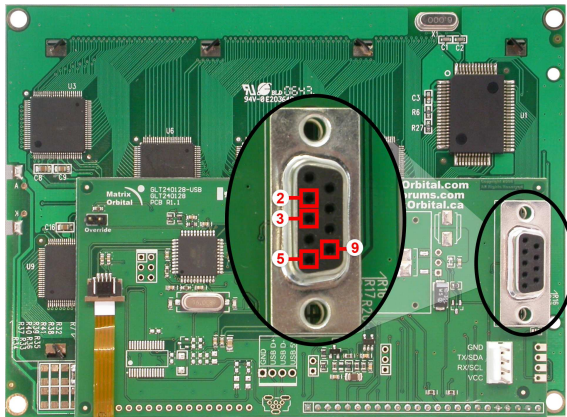

Figure 14: Touchpad Interface Connector

## 2.3 DB-9 Connector for Non-USB modules only

The GLT240128 provides a *DB-9 Connector* to readily interface with serial devices which use the EIA232 standard signal levels of  $\pm 9V$ . It is also possible to communicate at TTL levels of 0 to +5V by setting the *Protocol Select Jumpers* to TTL. As an added feature it is also possible to apply power through pin 9 of the *DB-9 Connector* in order to reduce cable clutter. However, in order to accomplish this you must set the *Power Through DB-9 Jumper*.



- Pin 2** RX/SCL (I<sup>2</sup>C clock)
- Pin 3** TX/SDA (I<sup>2</sup>C data)
- Pin 5** GND
- Pin 9** PWR (Must solder power through DB-9 jumper. See table 78)

Figure 15: RS-232 Pin-out

## 2.4 Power Through DB-9 Jumper

In order to provide power through pin 9 of the *DB-9 Connector* you must place a solder jumper on the *Power through DB-9 Jumper* pictured in Figure 16 below. The GLT240128 allows all voltage models to use the power through DB-9 option, see table 78 for display module voltage requirements.

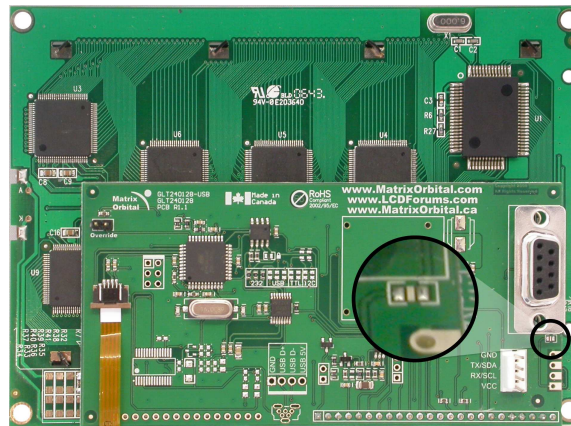

Figure 16: Power Through DB-9 Jumper



**WARNING** Do not apply voltage through pin 9 of the DB-9 connector AND through the Power/Data Connector at the same time.

**NOTE** We do not recommend that you use pin 9 (Ring Indicator) of the PC to power the display module. You will have to make a special DB9 cable.



## 2.5 Optional USB Header for USB modules only

The GLT240128 USB version has an optional four pin header for internal USB communications with host units. This provides the same communication lines as the regular header, albeit in a different form factor for greater customization. Again, please see 78 for power requirements.

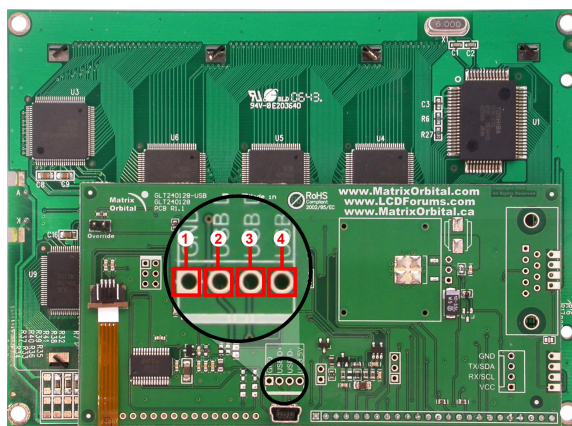

- Pin 1** GND
- Pin 2** D+
- Pin 3** D-
- Pin 4** Vcc (see table 78 on page 62)

Figure 17: Optional Internal USB Header

## 2.6 Protocol Select Jumpers

The *Protocol Select Jumpers*, pictured below in Figure 18, provide the means necessary to toggle the display module between RS-232 and TTL protocol levels. As a default for Non-USB modules, the jumpers are set to RS-232 mode with zero ohm resistors on the 232 jumpers. In order to place the display module in I<sup>2</sup>C mode you must first remove the zero ohm resistors from the 232 jumpers and then solder the resistors on to the I<sup>2</sup>C jumpers, or bridge solder across the pads. The display will now be in I<sup>2</sup>C mode and have a default slave address of 0x50 unless the I<sup>2</sup>C address has been changed. Similarly, in order to change the display to TTL mode, simply remove the zero ohm resistors from the 232 or I<sup>2</sup>C jumpers and solder them to the TTL jumpers. Although RS-232, USB, TTL and I<sup>2</sup>C are present, only 232/TTL/I<sup>2</sup>C are for use in the Non-USB module. For the USB module operation the USB jumpers must be in place. There are three, one is for power. If you wish to power it up from a non-USB source, you must remove one of the jumpers. The jumper to remove is the rightmost USB jumper as seen in Figure 19.

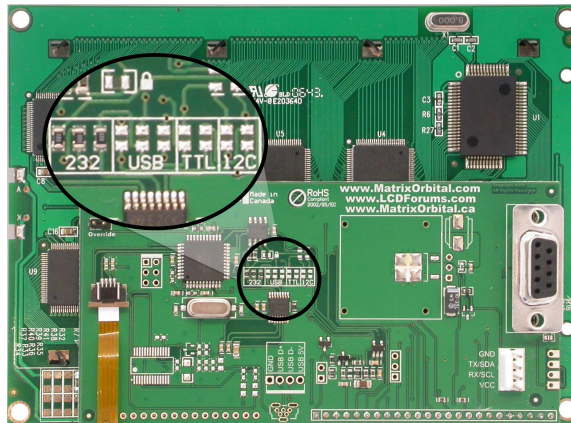

Figure 18: Protocol Select Jumpers for Serial and I<sup>2</sup>C modules

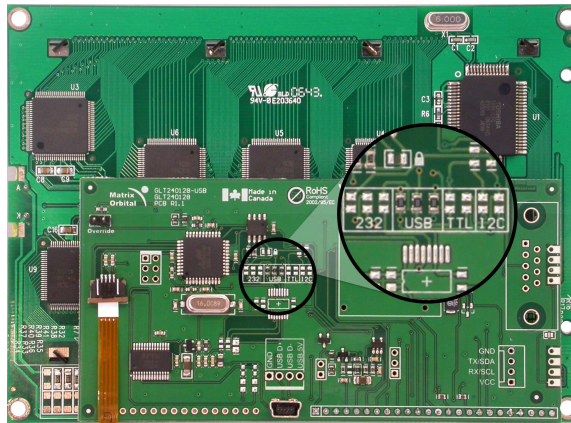

Figure 19: Protocol Jumpers for USB modules

## 2.7 Filesystem Lock Jumper

The Filesystem Lock Jumper allows you to lock the filesystem on the GLT240128 so that no fonts or bitmaps can be either written or deleted from the on board memory. This feature is useful in order to protect data integrity of production units, if protection of other settings is required see Section 12

To lock the filesystem, solder a zero ohm resistor or use a solder jumper pictured in Figure 20 below.

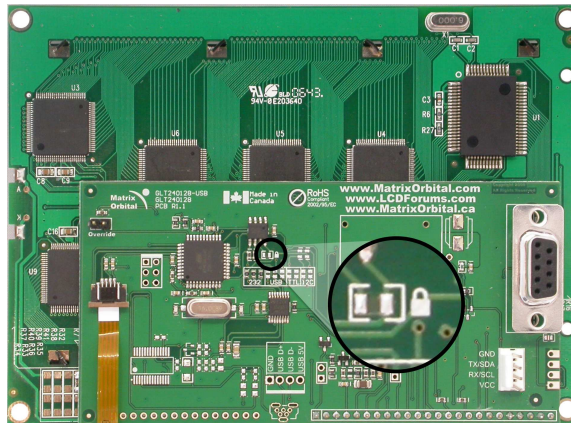

Figure 20: Filesystem Lock Jumper

## 2.8 Manual Override

The *Manual Override* is provided to allow the GLT240128 to be reset to some of the factory defaults. This can be particularly helpful if the display module has been set to an unknown baud rate or I<sup>2</sup>C and you are no longer able to communicate with it. If you wish to return the module to its default settings you must:

1. Power off the display module.
2. Place a Jumper on the *Manual Override* pins, as pictured below.
3. Power up the display module.
4. The display module is now set to its default values listed below in table 1.
5. Edit and save settings.

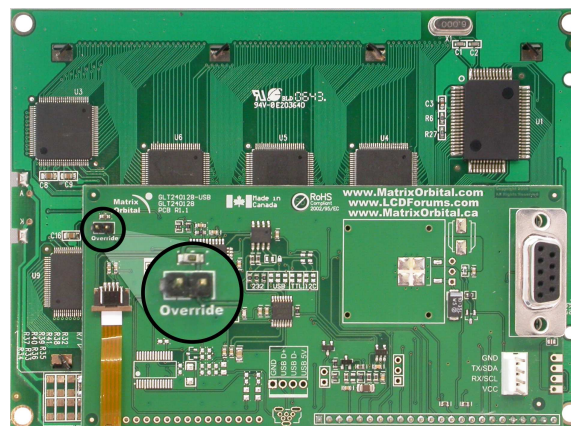

Figure 21: Manual Override Jumper

Table 1: Default Values

<b>Contrast</b>	128
<b>Backlight</b>	255
<b>Baud Rate</b>	19.2 kbps
<b>Data Lock</b>	False

---

**NOTE** The display module will revert back to the old settings once turned off, unless the settings are saved.

---

## 3 Troubleshooting

### 3.1 The display does not turn on when power is applied.

- First, you will want to make sure that you are using the correct power connector. Standard floppy drive power cables from your PC power supply may fit on the Power/Data Connector however they do not have the correct pinout as can be seen in Figure ???. Matrix Orbital supplies power cable adapters for connecting to a PC, which can be found in the Accessories Section on page 2.
- The next step is to check the power cable which you are using for continuity. If you don't have an ohm meter, try using a different power cable, if this does not help try using a different power supply.
- The last step will be to check the *Power / Data Connector* on the GLT240128. If the *Power / Data Connector* has become loose, or you are unable to resolve the issue, please contact Matrix Orbital see 15.6 on page 64 for contact information.

### 3.2 The display module is not communicating.

- First, check the communication cable for continuity. If you don't have an ohm meter, try using a different communication cable. If you are using a PC try using a different Com port.
- Second, please ensure that the display module is set to communicate on the protocol that you are using, by checking the *Protocol Select Jumpers*. To change the protocol used by the display module see Section 2.6 on page 12.
- Third, ensure that the host system and display module are both communicating on the same baud rate. The default baud rate for the display module is 19200 bps.
- \* If you are communicating to the display via I<sup>2</sup>C please ensure that the data is being sent to the correct address. The default slave address for the display module is 0x50.

---

**NOTE** I<sup>2</sup>C communication will always require pull up resistors.

---

- Finally, you may reset the display to it's default settings using the Manual Override Jumper, see Section 2.8 on the preceding page.

### 3.3 The display module is communicating, however text cannot be displayed.

- The cause of this is often that no font has been loaded onto the display. To load a font onto the display see Section 4.2.1 on page 16.
- Another common cause may be that the contrast settings have been set to low. The solution to this problem is to adjust the contrast settings, the default setting that will work in most environments is 128

---

**NOTE** Optimal contrast settings may vary according to factors such as temperature, viewing angle and lighting conditions.

---

### 3.4 There is a problem uploading fonts or bitmaps.

- First, ensure that you can communicate to the display. A good test is to use a PC, with MOGD# installed, to connect to the display. See Section 1.4 on page 4 for setting up a PC to test the GLT240128.
- Second, ensure that the Filesystem Lock Jumper has not been set. See Section 2.7 on page 13.
- Third, please ensure that the display module's memory is not full. The GLT240128 has 16 Kb of memory for fonts and bitmaps.

---

**NOTE** If you are unable to resolve any issue please contact Matrix Orbital. See 15.6 on page 64 for contact information.

---

## 4 Communications

### 4.1 Introduction

The commands listed in this chapter describe how to configure data flow on the GLT24064.

#### 4.1.1 I<sup>2</sup>C Communication Summary

The GLT24064 is capable of communicating at 100 KHz in I<sup>2</sup>C mode, with 127 units addressable on a single I<sup>2</sup>C communication line. However, in order to communicate via I<sup>2</sup>C you must first ensure that pull up resistors, with a nominal value of 1K to 10K, are placed on the SCL and SDA communication lines coming from pins two and three of the Data / Power Connector respectively. Data responses by the module are automatically output via RS232, in case the host will be querying the module, it is necessary for the host to inform the module that its responses are to be output via I<sup>2</sup>C. This can be done by sending command 254 /160 / 0 to turn off auto transmission of data in RS232. This will keep the data in the buffer until the master clocks a read of the slave. The I<sup>2</sup>C data lines operate at 5V normally or 3.3V for -1U style units. The GLT24064 uses 8-bit addressing, with the 8th or Least Significant Bit (LSB) bit designated as the read/write



bit, a 0 designates a write address and a 1 designates a read address. The default read address of the display module will be 0x51, whereas the write address is 0x50 by default. This address may be changed by using cmd 254 / 51 / <address>. The GLT24064 should only be sent addresses that are even (LSB is 0). When the I<sup>2</sup>C master wishes to write to the display, the effective address is \$50 (0101 0000) , since the LSB has to be 0 for an I<sup>2</sup>C master write. When the I<sup>2</sup>C master wishes to read the GLT24064, the effective address is \$51 (0101 0001), since the LSB has to be 1 for an I<sup>2</sup>C master read.

If we take a standard Phillips 7 bit address of \$45 (100 0101), Matrix Orbital's GLT24064 would describe this Phillips I<sup>2</sup>C address as \$8A (1000 1010). The read address would be \$8B (1000 1011).

The unit does not respond to general call address (\$00).

When communicating in I<sup>2</sup>C the GLT24064 will send an ACK on the 9th clock cycle when addressed. When writing to the display module, the display will respond with a ACK when the write has successfully been completed. However if the buffer has been filled, or the module is too busy processing data it will respond with a NAK. When performing a multiple byte read within one I<sup>2</sup>C transaction, each byte read from the slave should be followed by an ACK to indicate that the master still needs data, and a NAK to indicate that the transmission is over.

The GLT24064 has some speed limitations, especially when run in I<sup>2</sup>C mode. Here are some considerations when writing I<sup>2</sup>C code:

- \* to be able to read the replies of query commands (eg. cmds 54, 55) the following command must be sent (only needs to be sent once, so this can be done somewhere in init): 254 / 160 / 0 this command puts the reply data in the I<sup>2</sup>C output buffer instead of the RS232 output buffer. Please note that due to a 16 byte output buffer, query commands that reply with more than 16 bytes cannot be read (eg cmd Get FileSystem Directory)

- \* 3ms delay between the read commands

- \* 625us delay in between data bytes within a transaction is necessary

- \* 375us between transactions is necessary

---

**NOTE** These delays are conservative, and may be decreased based on performance

---

## 4.1.2 I<sup>2</sup>C Transaction Example

The typical I<sup>2</sup>C transaction contains four parts: the start sequence, addressing, information, and stop sequence. To begin a transaction the data line, SDA, must toggle from high to low while the clock line, SCL, is high. Next, the display must be addressed using a one byte hexadecimal value, the default to write to the unit is 0x50, while read is 0x51. Then information can be sent to the unit; even when reading, a command must first be sent to let the unit know what type of information it is required to return. After each bit is sent, the display will issue an ACK or NACK as described above. Finally, when communication is complete, the transaction is ended by toggling the data line from low to high while the clock line is high. An example of the use of this algorithm to write a simple "HELLO" message can be seen in 2.

Table 2: I<sup>2</sup>C Transaction Algorithm

<b>START</b>	Toggle SDA high to low
<b>Address</b>	0x50
<b>Information</b>	0x48 0x45 0x4C 0x4C 0x4F
<b>STOP</b>	Toggle SDA low to high

### 4.1.3 Serial Communication

In addition to being able to communicate via I<sup>2</sup>C the GLT24064 communicates natively through the RS-232 protocol at a default baud rate of 19,200 bps and is capable of standard baud rates from 9600 to 115,200 bps. Furthermore the GLT24064 is also capable of reproducing any non-standard baud rate in between using values entered into our baud rate generation algorithm and set through command 164 (0xA4). The display module communicates at standard voltage levels of -30V to +30V or at TTL levels of 0 to +5V by setting the *Protocol Select Jumpers* to TTL.

### 4.1.4 USB Communication

The GLT24064 is a USB device that offers identical communication protocol as the serial com port. capable of communicating via a USB interface. The USB communications are identical to the serial communications. Communication is via a virtual com port, which is created in the operating system by the drivers necessary to install the USB display. The GLT24064 communicating via USB is capable of baud rates of 19,200 bps to 115,200 bps. Other baud rates are subject to the limitation of the virtual com port driver. For further information regarding supported operating systems, and driver limitations please contact technical support.

## 4.2 Turn Flow Control On

Syntax	Hexadecimal	0xFE 0x3A [full] [empty]	
	Decimal	254 58 [full] [empty]	
	ASCII	254 “:” [full] [empty]	
Parameters	<b>Parameter</b>	<b>Length</b>	<b>Description</b>
	full	1	Bytes remaining before issuing a almost full message. (Full is 0)
	empty	1	Bytes available before issuing a almost empty message. (Empty is 128)

Description This command enables flow control. When the buffer fills so that only [full] bytes are available, the display will return an “almost full” message (0xFE) to the host controller. When the buffer empties so that only [empty] bytes remain, the display will return an “almost empty” message (0xFF) to the host controller.

The display will return the “almost full” message for every byte sent to the display until the used buffer space once more drops below the [full] level. Whether the user is in ‘flow control mode’ or not, the module will ignore display or command bytes which would overrun the buffer.

While in ‘flow control mode’ the unit will return 0xFE when buffer is almost full even though it may have already thrown rejected data away. The buffer size for the display is 128 bytes.

When using this command in an application, selection of the value for the buffer [full] should be considered very carefully. This is a critical aspect to be able to use this feature to it’s full potential. When using a host system or PC which contains a FIFO, the user should set the value of [full] equal to or greater than the size of the FIFO. The reason for this is that the FIFO may be full when the host system receives 0xFE. In the case of 16550 UART the size at its maximum is 16, therefore the value of [full] should be set to 16 or greater. It is suggested that the “almost full” parameter be equal to the largest chunk of data the host will be sending the display (should be less than 127).

---

**NOTE** This command is not available in I<sup>2</sup>C mode.

---

Remembered Yes  
 Default Off

### 4.3 Turn Flow Control Off

Syntax Hexadecimal 0xFE 0x3B  
 Decimal 254 59  
 ASCII 254 “;”

Description This command turns off flow control. Bytes may overflow the buffer without warning.

---

**NOTE** This command is not available in I<sup>2</sup>C mode.

---

Remembered Yes

### 4.4 Changing the I<sup>2</sup>C Slave Address



Syntax	Hexadecimal	0xFE 0x33 [adr]	
	Decimal	254 51 [adr]	
	ASCII	254 “3” [adr]	
Parameters	Parameter	Length	Description
	adr	1	The new I <sup>2</sup> C write address (0x00 - 0xFF).
Description	This command sets the I <sup>2</sup> C write address of the module between 0x00 and 0xFF. The I <sup>2</sup> C write address must be an even number and the read address is automatically set to one higher. For example if the I <sup>2</sup> C write address is set to 0x50, then the read address is 0x51.		

---

**NOTE** The change in address is immediate.

---

Remembered	Always
Default	0x50

## 4.5 Changing the Baud Rate

Syntax	Hexadecimal	0xFE 0x39 [speed]	
	Decimal	254 57 [speed]	
	ASCII	254 “9” [speed]	
Parameters	Parameter	Length	Description
	speed	1	Hex value corresponding to a baud rate.
Description	This command sets the RS-232 port to the specified [speed]. The change takes place immediately. [speed] is a single byte specifying the desired port speed. Valid speeds are shown in the table below. The display module can be manually reset to 19,200 baud in the event of an error during transmission, including transmitting a value not listed below, by setting the manual override jumper during power up. However, it should be noted that this command will be ignored until the manual override jumper is removed again.		

Hex Value	Baud Rate
0xCF	9600
0x8A	14400
0x67	19200
0x44	28800
0x33	38400
0x22	57600
0x19	76800
0x10	115200

Remembered	Always
Default	19,200 bps

## 4.6 Setting a Non-Standard Baud Rate

Syntax	Hexadecimal 0xFE 0xA4 [speed] Decimal 254 164 [speed]						
Parameters	<table border="1"> <thead> <tr> <th>Parameter</th> <th>Length</th> <th>Description</th> </tr> </thead> <tbody> <tr> <td>speed</td> <td>2</td> <td>Inputed LSB MSB from baud rate formula (12-2047).</td> </tr> </tbody> </table>	Parameter	Length	Description	speed	2	Inputed LSB MSB from baud rate formula (12-2047).
Parameter	Length	Description					
speed	2	Inputed LSB MSB from baud rate formula (12-2047).					
Description	<p>This command sets the RS-232 port to a non-standard baud rate. The command accepts a two byte parameter that goes directly into the modules baud generator. Use the formula, <math>speed = \frac{CrystalSpeed}{8 \times DesiredBaud} - 1</math> to calculate the [speed] for any baud rate setting. The speed can be anywhere from 12 to 2047 which corresponds to a baud range of 977 to 153,800 baud. Setting the baud rate out of this range could cause the display to stop working properly and require the Manual Override jumper to be set.</p>						
Remembered Examples	Always						

**Crystal Speed** 16 Mhz

**Desired BAUD** 13,500

$$speed = \frac{crystalspeed}{8 * DesiredBaud} - 1 \quad speed = \frac{16,000,000}{8 * 13,500} - 1$$

$$speed = 148.15 - 1$$

$$speed = 147.15$$

- **LSB** = 0x93 (rounded)
- **MSB** = 0x00
- Intended Baud Rate: 13,500 baud      Actual Baud Rate:  
 $\frac{16,000,000}{8(147+1)} = 13,514$       Percent Difference: 0.1%

---

### NOTES

- Results from the formula are rounded down to the nearest whole number (i.e 73.07 = 73).
  - This formula becomes less accurate as baud rates increase, due to rounding.
  - Place the speed result backwards into the formula to receive the actual baud rate. ( $Baud = \frac{CrystalSpeed}{8(speed+1)}$ )
  - The actual baud rate must be within 3% of the intended baud rate for the device to communicate.
-

# 5 Fonts

## 5.1 Introduction

The GLT24064 comes loaded with the 'Small Filled' and 'Futura Bk BT 16' fonts by default. However, it is capable of displaying any font that is uploaded to it in the correct format. MOGD# provides a simple method of generating font files from your installed fonts. For instructions on how to install MOGD# see *Section 1.5.1 on page 5*.

### 5.1.1 Font File Format

A font file consists of three parts, a header, a character table and bitmap data.

1. Header (4 bytes)
  - (a) Nominal Width (1 byte)
  - (b) Height (1 byte)
  - (c) ASCII Start Value (1 byte)
  - (d) ASCII End Value (1 byte)
2. Character Table (3 bytes for every character between the ASCII Start and End values inclusive)
  - (a) High Offset MSB (1 byte)
  - (b) Low Offset LSB (1 byte)
  - (c) Character Width (1 byte)
3. Bitmap Data

### 5.1.2 Creating a Font

The following is an example of how to create a font file for the letters *h*, *i* and *j*.

First you must create the bitmaps containing the character data in bitmap form. *Figure 22* below illustrates the bit pattern for the *h*, *i* and *j* bitmap data.

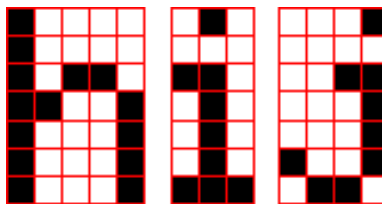

Figure 22: Bitmaps for h, i, and j

Second you may begin to create the font file starting with the header. The header will contain the nominal width, the height and the ASCII start and end values inclusive that you wish to create characters for.

Table 8: Font File Header

Nominal Width	Height	ASCII Start Val	ASCII End Val
0x05	0x07	0x68	0x6A

Next we will have to find out how many bytes each character will use up, in order to create the character table. The bitmaps are encoded horizontally and may have variable widths, *h* has a width of five, *i* a width of three and *j* a width of four, see the figure below for an example of encoding the first letter *h*:

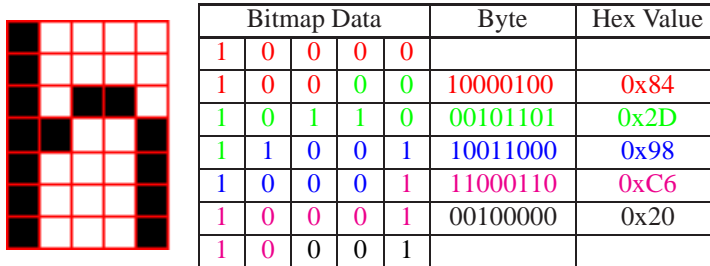

Figure 23: Bitmap Encoding

As you can see the letter *h* will take up five bytes with the last five bits being zero padded to form a full byte. So if you continue the process you will get the character data as seen in **table 5.1.2**.

Character Data

	Character Data					Byte Size (For Reference)
<i>h</i>	0x84	0x2D	0x98	0xC6	0x20	0x05
<i>i</i>	0x43	0x24	0x84			0x03
<i>j</i>	0x2D	0x98	0x19	0x60		0x04

The second part of the font file is the character table. The character table is comprised of three bytes for every glyph in the font file.

The first two bytes represents the position, in bytes, of the glyph stored MSB LSB referenced from the beginning of the file (including the header. The third byte is the width of the glyph in pixels. So because there will be 0x09 bytes in the character table (three bytes for each glyph) and four bytes in the header section, the first entry in the table will be 13, or 0x00 0x0D in hexadecimal, and 0x05 for the width.

To calculate the second entry in the character table, representing the position and width of the second glyph, take the offset of the first entry and add the size of the first bitmap in bytes. Since the first glyph occupies 0x05 bytes as seen in table 5.1.2 above, and the offset is 0x00 0x0D, the offset of the second entry will be 0x00 0x12 and the width of the glyph is 0x03.

Calculate the third entry the same way as the second to get **table 9** below.

Table 9: Character Table

	High Offset (MSB)	Low Offset (LSB)	Character Width
<i>h</i>	0x00	0x0D	0x05
<i>i</i>	0x00	0x12	0x03
<i>j</i>	0x00	0x15	0x04

Once completed, place the character table after the header and the character data at the end, as seen in *table 10*.

Table 10: Sample Font File

0x05	0x07	0x68	0x6A	0x00	0x0D	0x05	0x00
0x12	0x03	0x00	0x15	0x04	0x84	0x2D	0x98
0xC6	0x20	0x43	0x24	0x84	0x2D	0x98	0x19
0x60							

Red = **Header**

Blue = **Character Table**

Purple = **Character Data**

## 5.2 Uploading a Font File

Syntax	Hexadecimal	0xFE 0x24 [refID] [size] [data]	
	Decimal	254 36 [refID] [size] [data]	
	ASCII	254 "\$" [refID] [size] [data]	
Parameters	Parameter	Length	Description
	refID	1	A unique font identification number.
	size	2	Font file size (LSB to MSB).
	data	x	Font file data.
Description	<p>In order to upload a font to the GLT24064 you must first initiate the upload font file command (0xFE 0x24), you must then pass it a reference identification number, which must be unique for every font on the display module. You may then pass the display module the two byte file size, which needs to be transferred LSB, then MSB. The last part of uploading a font is transmitting the font file data.</p> <p>For detailed instructions on uploading a file to the GLT24064 see <i>Section 11 on page 43</i>.</p>		

---

**NOTE** This command is available but not supported in I<sup>2</sup>C.

---

Remembered Always

## 5.3 Setting the Current Font

Syntax	Hexadecimal	0xFE 0x31 [refID]
	Decimal	254 49 [refID]
	ASCII	254 "1" [refID]

Parameters	Parameter	Length	Description
	refID	1	A unique font identification number.
Description	<p>In order to set the font on the GLT24064 you must know the font identification number of the font that you wish to use. The font ID is established when the font is saved to the display. The default installed fonts are “Small Filled” and “Futura Bk BT 16” and their font ID’s are 0x01 and 0x02 respectfully, with “Small Filled” being the default selected font.</p> <p>Once you are aware of the font ID for the font that you wish you use, simply send the command bytes (0xFE 0x31) and then send the font ID corresponding to the font. A directory listing of the contents of the entire filesystem may be obtained by using the “Get Filesystem Directory” command, see Section 11.5 on page 48 for more detailed information.</p>		
Remembered	Yes		

## 5.4 Font Metrics

Syntax	Hexadecimal	0xFE 0x32	[lm] [tm] [csp] [lsp] [srow]
	Decimal	254 50	[lm] [tm] [csp] [lsp] [srow]
	ASCII	254 “2”	[lm] [tm] [csp] [lsp] [srow]
Parameters	Parameter	Length	Description
	lm	1	Left margin: Location in pixels.
	tm	1	Top margin: Location in pixels.
	csp	1	Character Spacing: Amount of space in pixels between characters.
	lsp	1	Line Spacing: Amount of space between lines in pixels.
	srow	1	Scroll Row: The Y location of the last row in pixels.
Description	<p>Font metrics define where the characters are positioned on the screen, by setting where the rows and columns begin based on the [lm][tm][csp][lsp][srow] parameters. [lm] defines the leftmost position and [tm] the topmost. [csp] controls the amount of pixels that are placed in between characters and [lsp] controls the amount of pixels that are placed in between lines. [srow] is the location of the top of the last row that will be displayed on the GLT24064. It defines the row that, when filled, will cause the display to auto scroll if auto scrolling is enabled. The font metrics will have to be reconfigured after changing to a different font.</p>		
Remembered	Yes		

## 5.5 Set Box Space Mode

Syntax	Hexadecimal	0xFE 0xAC [value]	
	Decimal	254 172 [value]	
Parameters	Parameter	Length	Description
	value	1	Value (0: Off, 1: On)
Description	This command will toggle the box space mode. Box space mode is when a box, the size of the character to be written, is printed to the display before a character is written.		
Remembered	Yes		
Default	On		

## 6 Text

### 6.1 Introduction

The GLT24064 is an intelligent display module, designed to reduce the amount of code necessary to begin displaying data. This means that it is able to display all ASCII formatted characters and strings that are sent to it, which are defined in the current character set. The display module will begin displaying text at the top left corner of the display area, known as home, and continue to print to the display as if it was a page on a typewriter. When the text reaches the bottom right row, it is able to automatically scroll all of the lines up and continue to display text, with the auto scroll option set to on.

#### 6.1.1 Character Set

The graphic displays such as the GLT24064, do not have built in character sets. Instead fonts are uploaded to the display using the commands detailed in Section 5 on page 22.

#### 6.1.2 Control Characters

In addition to a full text set, the GLT24064 display supports the following ASCII Control characters:

**0x0A** Line feed / New line - when this value is not defined in the font file. This command will create a new line on the display. If scrolling is on and the display is at the bottom of the screen, the whole screen is scrolled up.

### 6.2 Move Cursor Home

Syntax	Hexadecimal	0xFE 0x48
	Decimal	254 72
	ASCII	254 “H”
Description	This command moves the text insertion point to the top left of the display area (Row 1, Column 1).	
Remembered	No	

### 6.3 Setting the Cursor Position

Syntax	Hexadecimal	0xFE 0x47 [col] [row]	
	Decimal	254 71 [col] [row]	
	ASCII	254 “G” [col] [row]	
Parameters	Parameter	Length	Description
	col	1	Column
	row	1	Row
Description	This command sets the text insertion point to the [col] and [row] specified. The insertion point is positioned using the base size of the current font (this command does not position the insertion point at a specific pixel). The column used is determined by multiplying the width of the widest character in the font by the [column]. The row used is determined by multiplying the height of the font by [row + Metrics: line spacing].		
Remembered	No		

### 6.4 Setting the Cursor Coordinate

Syntax	Hexadecimal	0xFE 0x79 [x] [y]	
	Decimal	254 121 [x] [y]	
	ASCII	254 “y” [x] [y]	
Parameters	Parameter	Length	Description
	x	1	The horizontal position in pixels.
	y	1	The vertical position in pixels.
Description	This command positions the insertion point at a specific pixel (X,Y), which references the top left corner of the font insertion point.		
Remembered	No		

### 6.5 Auto Scroll On



Syntax	Hexadecimal	0xFE 0x51
	Decimal	254 81
	ASCII	254 “Q”
Description	When auto scrolling is on, it causes the display to shift the entire display’s contents up to make room for a new line of text when the text reaches the end of the scroll row defined in the font metrics (the bottom right character position) see <i>Section 5.4 on page 25</i> .	
Remembered	Yes	
Default	On	

## 6.6 Auto Scroll Off

Syntax	Hexadecimal	0xFE 0x52
	Decimal	254 82
	ASCII	254 “R”
Description	When auto scrolling is disabled, text will wrap to the top left corner of the display area when the text reaches the end of the scroll row defined in the font metrics (the bottom right character position) see <i>Section 5.4 on page 25</i> . Existing text in the display area is not erased before new text is placed. A series of spaces followed by a “Cursor Home” command may be used to erase the top line of text.	
Remembered	Yes	

## 7 Bitmaps

### 7.1 Introduction

One of the main features of the GLT24064 is its ability to display bitmap images, that are either loaded onto its on board memory, or written directly to the screen. This chapter will cover creating a bitmap, uploading the bitmap, as well as drawing the bitmap from memory and directly.

### 7.2 Uploading a Bitmap File

Syntax	Hexadecimal	0xFE 0x5E [refID] [size] [data]
	Decimal	254 94 [refID] [size] [data]
	ASCII	254 “^” [refID] [size] [data]

Parameters	Parameter	Length	Description
	refID	1	A unique bitmap identification number.
	size	2	Bitmap file size (LSB to MSB).
Description	data	x	Bitmap data.
	<p>The GLT24064 is capable of storing 128 font and bitmap files up to 16 Kbytes total. In order to upload a bitmap to the GLT24064 you must first initiate the upload font file command (0xFE 0x5E), you must then pass it a reference identification number, which must be unique for every font on the display module. You may then pass the display module the two byte file system size, which needs to be transferred LSB, then MSB. This is almost always the entire 16kB, meaning the values 0x00 0x40 0x00 0x00 must be issued. The last part of uploading a bitmap is transmitting the bitmap file data.</p> <p>For detailed instructions on uploading a file to the GLT24064 see <i>Section 11 on page 43</i>.</p>		
<hr/> <p><b>NOTE</b> This command is available but not supported in I<sup>2</sup>C.</p> <hr/>			
Remembered	Always		

### 7.3 Drawing a Bitmap from Memory

Syntax	Hexadecimal	0xFE 0x62 [refID] [X] [Y]	
	Decimal	254 98 [refID] [X] [Y]	
	ASCII	254 "b" [refID] [X] [Y]	
Parameters	Parameter	Length	Description
	refID	1	The bitmap identification number.
	X	1	Left bounds.
	Y	1	Top bounds.
Description	<p>This command will draw a bitmap that is located in the on board memory. The bitmap is referenced by the bitmaps reference identification number, which is established when the bitmap is uploaded to the display module. The bitmap will be drawn beginning at the top left, from the specified X,Y coordinates. A directory listing of the contents of the entire filesystem may be obtained by using the "Get Filesystem Directory" command, see Section 11.5 on page 48 for more detailed information.</p>		
Remembered	No		

## 7.4 Drawing a Bitmap Directly

Syntax	Hexadecimal	0xFE 0x64 [X] [Y] [W] [H] [D]	
	Decimal	254 100 [X] [Y] [W] [H] [D]	
	ASCII	254 “d” [X] [Y] [W] [H] [D]	
Parameters	Parameter	Length	Description
	X	1	Left bounds.
	Y	1	Top bounds.
	W	1	Width
	H	1	Height
	D	(width*height)/8	Data
Description	Drawing a bitmap to the GLT24064, without first uploading the image to the memory can be a very useful feature for drawing images that are not used very often. In order to accomplish this, you must supply the display module with the X,Y coordinates, representing the top left corner of where you would like to draw the bitmap on the screen, as well as the width and the height of the bitmap. After you have supplied this data you may then upload the bitmap data to the GLT24064. The length of this file is the bitmap width multiplied by height, divided by eight. The bitmap data is encoded into bytes horizontally and is transferred the same as if you were uploading a file, see <i>Section 11 on page 43</i> for more information about transferring data to the display module.		

---

**NOTE** Drawing a bitmap directly to the display is supported by flow control. This command is available but not support in I<sup>2</sup>C mode.

---

Remembered No

## 8 Bar Graphs and Drawing

### 8.1 Introduction

Supplementary to the ability of the GLT24064 to display bitmaps and fonts, the GLT24064 also allows for a robust 2D drawing environment. With the ability to draw by pixel, line or rectangle, as well as the ability to continue a line to form a polygon, we are certain that you will spend less time, developing and creating better looking projects. With the addition of custom bar and strip graphs, you are sure to find the right tools to make any graphical layout a success.

### 8.2 Set Drawing Color

Syntax	Hexadecimal	0xFE 0x63 [color]	
	Decimal	254 99 [color]	
	ASCII	254 "c" [color]	
Parameters	Parameter	Length	Description
	color	1	Drawing color (0: White, 1-255: Black).
Description	This command sets the drawing color for subsequent graphic commands that do not have the drawing color passed as a parameter. The parameter [color] is the value of the color where white is 0 and black is 1-255.		
Remembered	No		

### 8.3 Draw Pixel

Syntax	Hexadecimal	0xFE 0x70 [x] [y]	
	Decimal	254 112 [x] [y]	
	ASCII	254 "p" [x] [y]	
Parameters	Parameter	Length	Description
	x	1	X screen location.
	y	1	Y screen location.
Description	This command will draw a pixel at (x,y) using the current drawing color. The unit processes these requests fast enough to keep up with a steady stream at 115 Kbps so flow control is not required.		
Remembered	No		

### 8.4 Drawing a Line

Syntax	Hexadecimal	0xFE 0x6C [x1] [y1] [x2] [y2]	
	Decimal	254 108 [x1] [y1] [x2] [y2]	
	ASCII	254 "l" [x1] [y1] [x2] [y2]	
Parameters	Parameter	Length	Description
	x1	1	Left bounds.
	y1	1	Top Bounds.
	x2	1	Right Bounds.
	y2	1	Bottom Bounds.
Description	This command will draw a line from (x1,y1) to (x2,y2) using the current drawing color. Lines may be drawn from any part of the display to any other part. However, it may be important to note that the line may interpolate differently right to left, or left to right. This means that a line drawn in white from right to left may not fully erase the same line drawn in black from left to right.		
Remembered	No		

## 8.5 Continue a Line

Syntax	Hexadecimal	0xFE 0x65 [x] [y]	
	Decimal	254 101 [x] [y]	
	ASCII	254 "e" [x] [y]	
Parameters	Parameter	Length	Description
	x	1	Left bounds.
	y	1	Top Bounds.
Description	This command will draw a line with the current drawing color from the last line end (x2,y2) to (x,y). This command uses the global drawing color.		
Remembered	No		

## 8.6 Draw a Rectangle

Syntax	Hexadecimal	0xFE 0x72 [color] [x1] [y1] [x2] [y2]	
	Decimal	254 114 [color] [x1] [y1] [x2] [y2]	
	ASCII	254 "r" [color] [x1] [y1] [x2] [y2]	
Parameters	Parameter	Length	Description
	color	1	Drawing color (0: White, 1-255: Black).
	x1	1	Left bounds.
	y1	1	Top Bounds.
	x2	1	Right Bounds.
	y2	1	Bottom Bounds.
Description	This command draws a rectangular box in the specified color (0: White, 1: Black). The top left corner is specified by (x1,y1) and the bottom right corner by (x2,y2).		
Remembered	No		

## 8.7 Drawing a Solid Rectangle

Syntax	Hexadecimal	0xFE 0x78 [color] [x1] [y1] [x2] [y2]
	Decimal	254 120 [color] [x1] [y1] [x2] [y2]
	ASCII	254 "x" [color] [x1] [y1] [x2] [y2]

Parameters	Parameter	Length	Description
	color	1	Drawing color (0: White, 1-255: Black).
	x1	1	Left bounds.
	y1	1	Top Bounds.
	x2	1	Right Bounds.
	y2	1	Bottom Bounds.
Description	This command draws a solid rectangle in the specified color (0: White, 1: Black). The top left corner is specified by (x1,y1) and the bottom right corner by (x2,y2). Since this command involves considerable processing overhead, we strongly recommend the use of flow control, particularly if the command is to be repeated frequently.		
Remembered	No		

## 8.8 Initializing a Bar Graph

Syntax	Hexadecimal	0xFE 0x67 [refID] [type] [x1] [y1] [x2] [y2]	
	Decimal	254 103 [refID] [type] [x1] [y1] [x2] [y2]	
	ASCII	254 "g" [refID] [type] [x1] [y1] [x2] [y2]	
Parameters	Parameter	Length	Description
	refID	1	Reference number
	type	1	Type of bar graph.
	x1	1	Left bounds.
	y1	1	Top Bounds.
	x2	1	Right Bounds.
	y2	1	Bottom Bounds.

Description This command initializes a bar graph referred to by number [reference number] of type [type] with size from (x1,y1) (top left) to (x2,y2) (bottom right). A maximum of 16 bar graphs with reference numbers from 0 to 15 can be initialized as:

[type]	Direction	Bar Start Point
<b>0</b>	Vertical	Bottom
<b>1</b>	Horizontal	Left
<b>2</b>	Vertical	Top
<b>3</b>	Horizontal	Right

The bar graphs may be located anywhere on the display, but if they overlap, they will not display properly.

It is important that [x1] is less than [x2], and [y1] is less than [y2]. This command doesn't actually draw the graph, it must be filled in using the Fill Bar Graph command. The unit saves time by only drawing that part of the bar graph which has changed from the last write, so the representation on the screen may not survive a screen clear or other corrupting action. A write of value zero, followed by new values will restore the proper look of the bar graph.

Remembered No

## 8.9 Drawing a Bar Graph

Syntax	Hexadecimal	0xFE 0x69 [ref] [value]	
	Decimal	254 105 [ref] [value]	
	ASCII	254 "i" [ref] [value]	
Parameters	Parameter	Length	Description
	ref	1	Initialized bar graph reference number.
	value	1	The number of pixels to fill.
Description	Once the bar graph has been initialized it can be filled in using this command. This command sets the bar graph specified by the [ref] number to fill in [value]. [value] is given in pixels and should not exceed the available height/width of the graph. (If it does the graph will simply be written to its maximum size.)		
Remembered	No		

## 8.10 Initializing a Strip Chart

Syntax	Hexadecimal	0xFE 0x6A [refID] [x1] [y1] [x2] [y2]
	Decimal	254 106 [refID] [x1] [y1] [x2] [y2]
	ASCII	254 "j" [refID] [x1] [y1] [x2] [y2]

Parameters	Parameter	Length	Description
	refID	1	Reference number
	x1	1	Left bounds.
	y1	1	Top Bounds.
	x2	1	Right Bounds.
	y2	1	Bottom Bounds.

Description A strip chart is an area of the screen reserved for horizontal scrolling. This is normally used as follows:

- Initialize the strip chart, which reserves the appropriate area of the screen.
- Draw a line segment at the right or left side of the strip chart.
- Shift the strip chart to the right or left.
- Draw the next line segment.
- Used this way the strip chart can produce a graph which scrolls smoothly horizontally in either direction. With text the strip chart can produce a marquis effect.

---

**NOTE** If the strip chart is used with text we recommend the use of a 6 or 7 pixel wide fixed width character set, with each character placed 8 pixels from the start of the previous one.

---

Up to 7 strip charts ([ref] = 0 - 6) may be defined. To initialize a strip chart the user must define an area on the display in which to place the strip chart. (x1,y1) is the top left corner of the area to be used, where [x1] is the placement of the column where the strip chart is to begin and [y1] is the row. The user must then define [x2] as the bottom right column of the area to be utilized and [y2] as the bottom right row.

---

**NOTE** The definition of x must lie on byte boundaries. That is, x must be defined as 0x00, 0x08, 0x10, etc. This restriction does not apply to y values.

---

Remembered No

## 8.11 Shifting a Strip Chart

Syntax	Hexadecimal	0xFE 0x6B [ref]	
	Decimal	254 107 [ref]	
	ASCII	254 "k" [ref]	
Parameters	Parameter	Length	Description
	ref	1	Reference number of a strip chart that has already been created.



Description	<p>This command shifts the strip chart left or right. [ref] determines both which strip chart is used and which direction it will shift. The direction is selected by the most significant bit (MSB):</p> <ul style="list-style-type: none"> <li>• MSB: 0 shifts left</li> <li>• MSB: 1 shifts right</li> </ul> <p>For example if [ref] is 1:</p> <ul style="list-style-type: none"> <li>• 254 107 1 (hex FE 6B 01) shifts left</li> <li>• 254 107 129 (hex FE 6B 81) shifts right</li> </ul> <p>This command shifts the contents of the area defined in the Initialize Strip Chart command 8 pixels at a time.</p>
Remembered	No

## 9 Touchpad

### 9.1 Introduction

The Matrix Orbital touch pad interface replaces, and in many ways, supercedes the keypad input interface. It adds the functionality of a dynamically adjustable, software controlled keypad. This feature will add an updated touch to your application system.

#### 9.1.1 Region Mode

This mode will report touch events when they occur in one of thirty-two specified areas or issue a special byte when a press occurs outside any defined region. Depending on the region reporting mode selected, either the down, up, or over characters specified for a region will be transmitted when the area defined is pressed, released, or dragged over respectively. Return values are specified when a region is created, in addition to its position and size. These regions can be deleted either individually or collectively when they are no longer required.

#### 9.1.2 Co-ordinate Mode

This mode will report all touch events in any position on the screen. Each event will be superceded by a single byte value representing a press, release, or drag. Press events will be predecided by a 1, release movements by a 2, and drag moves will return a value 4. Afterwhich, two single byte values representing the x and y co-ordinates of the touch event will be transmitted. Only drag movements greater than the drag threshold specified will be sent to the host.

## 9.2 Set Touch Region

Syntax	Hexadecimal	0xFE 0x84 [num] [x] [y] [w] [h] [keyDown] [keyUp]	
	Decimal	254 132 [num] [x] [y] [w] [h] [keyDown] [keyUp]	
Parameters	Parameter	Length	Description
	num	1	Region number, each region must be identified by a unique number, single byte (32 region max).
	x	1	X co-ordinate of the top left corner of the region, single byte (0-Xmax).
	y	1	Y co-ordinate of the top left corner of the region, single byte (0-Ymax).
	w	1	Width of the region, single byte (0-Xmax).
	h	1	Height of the region, single byte (0-Ymax).
	keyDown	1	Value returned when region is pressed, single byte (0-255).
	keyUp	1	Value returned when region is released, single byte (0-255).
Description	This command creates a touchpad region that reports the key down or key up values saved to it when a press or release respectively is detected within the region defined.		
Remembered	Yes		

## 9.3 Delete Touch Region

Syntax	Hexadecimal	0xFE 0x85 [num]	
	Decimal	254 133 [num]	
Parameters	Parameter	Length	Description
	num	1	Region number to be deleted, single byte.
Description	This command deletes a previously created touchpad region, unique key presses will no longer be received from events in the area defined by the deleted region. All events in undefined regions will return 255.		
Remembered	Yes		

## 9.4 Delete All Touch Regions

Syntax	Hexadecimal	0xFE 0x86
	Decimal	254 134
Description	This command deletes all touch regions previously created. It is recommended that this command is issued before setting regions.	
Remembered	Yes	

## 9.5 Set Touch Mode

Syntax	Hexadecimal	0xFE 0x87 [mode]	
	Decimal	254 135 [mode]	
Parameters	Parameter	Length	Description
	mode	1	Touch pad mode. Region mode is 0, Co-ordinate mode is 1.
Description	This command sets the reporting mode for the touch pad. Region mode returns up and down values on press events within defined regions, while Co-ordinate mode reports every event on the touch pad with coordinates.		
Remembered	Yes		
Default	Co-ordinate Mode		

## 9.6 Set Region Reporting Mode

Syntax	Hexadecimal	0xFE 0x88 [mode]													
	Decimal	254 136 [mode]													
Parameters	Parameter	Length	Description												
	mode	1	Reporting mode for region press events.												
Description	This command sets the reporting mode for touch events in region mode. Defined key up and key down values will be sent only when certain reporting parameters are set.														
	<table border="1"> <thead> <tr> <th>Bit</th> <th>Reporting Parameter</th> </tr> </thead> <tbody> <tr> <td>0</td> <td>Press</td> </tr> <tr> <td>1</td> <td>Release</td> </tr> <tr> <td>2</td> <td>Drag</td> </tr> <tr> <td>3</td> <td>Out of Region</td> </tr> <tr> <td>4-7</td> <td>Reserved</td> </tr> </tbody> </table>			Bit	Reporting Parameter	0	Press	1	Release	2	Drag	3	Out of Region	4-7	Reserved
Bit	Reporting Parameter														
0	Press														
1	Release														
2	Drag														
3	Out of Region														
4-7	Reserved														
	Key down values are transmitted for press and drag events while key up values are sent on releases. Any out of region touches will be reported with 0xFF.														
Remembered	Yes														

Default  
Examples

Report All

0x01	Key down values are sent on touch presses only
0x03	Key down and key up values are sent on presses and releases respectively
0x06	Key down values are reported on press and drag events
0x0F	Key down values are sent on presses and drags, key up values on releases, and 0xFF on out of range

## 9.7 Set Dragging Threshold

Syntax	Hexadecimal	0xFE 0x89 [threshold]	
	Decimal	254 137 [threshold]	
Parameters	Parameter	Length	Description
	threshold	1	Touch pad dragging threshold, single byte value (1 to 255).
Description	This command specifies the distance a press must be dragged moved before a drag event is reported to the host. The lower the threshold the more values sent to the host, while the higher the value the less precise the drag reporting may be. Distance is calculated as $d = \sqrt{(x_2 - x_1)^2 + (y_2 - y_1)^2}$ . Care should be taken to find the appropriate balance between data points and accuracy.		
Remembered	Yes		
Default	8		

## 9.8 Set Pressure Threshold

Syntax	Hexadecimal	0xFE 0x8A [threshold]	
	Decimal	254 138 [threshold]	
Parameters	Parameter	Length	Description
	threshold	2	Touch pad pressure threshold, two byte value (1 to 65535).
Description	This command sets the pressure required to be placed upon the screen before a press event is recorded.		
Remembered	Yes		
Default	1000		

## 9.9 Run Touchpad Calibration

Syntax	Hexadecimal	0xFE 0x8B
	Decimal	254 139
Description	This command runs a calibration of the touch pad by specifying a number of points on the screen and prompting the user to press within them. It can be used to correct any errors noticed in touch pad events. If calibration is successful, the display will return two bytes, 0xFE and 0x15, to the host, otherwise it will return 0xFE and 0x14.. It is recommended that this command be used when environmental or user factors are changed to allow for correct operation.	
Remembered	Always	

## 10 Display Functions

### 10.1 Introduction

The GLT24064 employs software controlled display settings, which allow for control over, clearing the screen, changing the brightness and contrast or setting timers for turning it on or off. The combination of these allow you complete software control over your display's appearance.

### 10.2 Clear Screen

Syntax	Hexadecimal	0xFE 0x58
	Decimal	254 88
	ASCII	254 "X"
Description	This command clears the display and resets the text insertion position to the top left position of the screen defined in the font metrics.	
Remembered	No	

### 10.3 Display On

Syntax	Hexadecimal	0xFE 0x42 [min]	
	Decimal	254 66 [min]	
	ASCII	254 "B" [min]	
Parameters	Parameter	Length	Description
	min	1	Minutes before turning the display on (0 to 90).

Description	This command turns the backlight on after the [minutes] timer has expired, with a ninety minute maximum timer. A time of 0 specifies that the backlight should turn on immediately and stay on. When this command is sent while the remember function is on, the timer will reset and begin after power up.
Remembered	Yes
Default	0

## 10.4 Display Off

Syntax	Hexadecimal 0xFE 0x46 Decimal 254 70 ASCII 254 "F"
Description	This command turns the backlight off immediately. The backlight will remain off until a 'Display On' command has been received.
Remembered	Yes

## 10.5 Set Brightness

Syntax	Hexadecimal 0xFE 0x99 [brightness] Decimal 254 153 [brightness]						
Parameters	<table border="1"> <thead> <tr> <th>Parameter</th> <th>Length</th> <th>Description</th> </tr> </thead> <tbody> <tr> <td>brightness</td> <td>1</td> <td>Display brightness setting (0 to 255).</td> </tr> </tbody> </table>	Parameter	Length	Description	brightness	1	Display brightness setting (0 to 255).
Parameter	Length	Description					
brightness	1	Display brightness setting (0 to 255).					
Description	This command sets the display [brightness]. If the remember function is on, this command acts the same as 'Set and Save Brightness'.						
Remembered	Yes						
Default	255						

## 10.6 Set and Save Brightness

Syntax	Hexadecimal 0xFE 0x98 [brightness] Decimal 254 152 [brightness]						
Parameters	<table border="1"> <thead> <tr> <th>Parameter</th> <th>Length</th> <th>Description</th> </tr> </thead> <tbody> <tr> <td>brightness</td> <td>1</td> <td>Backlight setting (0 to 255).</td> </tr> </tbody> </table>	Parameter	Length	Description	brightness	1	Backlight setting (0 to 255).
Parameter	Length	Description					
brightness	1	Backlight setting (0 to 255).					
Description	This command sets and saves the display [brightness] as default.						
Remembered	Always						

## 10.7 Set Contrast

Syntax	Hexadecimal	0xFE 0x50 [contrast]	
	Decimal	254 80 [contrast]	
	ASCII	254 "P" [contrast]	
Parameters	Parameter	Length	Description
	contrast	1	Contrast value (0 to 255).
Description	This command sets the display's contrast to [contrast], where [contrast] is a value between 0x00 and 0xFF (between 0 to 255). Lower values cause 'on' elements in the display area to appear lighter, while higher values cause 'on' elements to appear darker. Lighting and temperature conditions will affect the actual value used for optimal viewing. Individual display modules will also differ slightly from each other in appearance. In addition, values for optimal viewing while the display backlight is on may differ from values used when backlight is off. This command does not save the [contrast] value, and is lost after power down; but this command has the option of remembering the settings when issued with the Remember function 'on'. When this is the case, this command is the same as the Set and Save Contrast command.		

---

**NOTE** This command has only 32 levels for X-Board based displays, meaning eight contrast settings will have the same single effect. Effectively, values 0 through 7, 8 through 15, and so on will result in the same setting.

---

Remembered	Yes
Default	128

## 10.8 Set and Save Contrast

Syntax	Hexadecimal	0xFE 0x91 [contrast]	
	Decimal	254 145 [contrast]	
Parameters	Parameter	Length	Description
	contrast	1	Contrast value (0 to 255).

Description This command sets the display's contrast to [contrast], where [contrast] is a value between 0x00 and 0xFF (between 0 to 255). Lower values cause 'on' elements in the display area to appear lighter, while higher values cause 'on' elements to appear darker. Lighting conditions will affect the actual value used for optimal viewing. Individual display modules will also differ slightly from each other in appearance. In addition, values for optimal viewing while the display backlight is on may differ from values used when backlight is off.

---

**NOTE** This command saves the [contrast] value so that it is not lost after power down.

---

Remembered Yes  
Default 128

## 11 Filesystem

### 11.1 Introduction

The GLT24064 incorporates a 16 Kbyte on board flash memory in order to allow up to 128 font and bitmap files to be transferred directly onto the display and recalled whenever necessary. The filesystem can address font and bitmap files combined up to 16 Kbytes. It is recommended that fonts and bitmaps are uploaded when possible all together after a filesystem wipe to preserve memory integrity. These fonts and bitmaps can then be locked to ensure they remain intact. This section covers uploading, downloading, deleting and moving files, as well as getting the remaining space or wiping the filesystem.

#### 11.1.1 File Upload Protocol

In order to allow fonts and bitmaps to be uploaded to the on board flash memory Matrix Orbital has developed a simple protocol that supports RS-232/TTL or I<sup>2</sup>C communications. In order to begin a file transmission the first step will be to provide the display module with the appropriate command bytes, meaning the command prefix, 0xFE, followed by the command number, 0x24 for a font file, or 0x5E for a bitmap file. This will begin the file transfer sequence. The next step will be to request a reference identification number (ref ID) which will allow you to identify the file for future use. Reference ID numbers can be any byte between 0x00 and 0x7F, however each ID must be unique.

The next part of uploading a font file is to provide the display module with the two byte file size of the data that you wish to transfer, LSB to MSB. The LSB must be transmitted first followed by the MSB. After receiving the MSB the display module will send a confirm byte, 0x01, if the file fits and continue, or decline byte, 0x08, and terminate the session.

Byte	Description
0x01	Confirm: Will continue the file transfer.
0x08	Decline: Terminate the session.



Host	Display	Comments
0xFE		Command Prefix
0x24		Upload Font File Command
0x01		Reference ID
0x19		Size (LSB)
0x00		Size (MSB)
	0x01	Confirmation Byte
0x01		Confirmation Byte
0x05		Font Width
	0x05	Echo Font Width
0x01		Confirmation Byte
0x07		Font Height
	0x07	Echo Font Height
0x01		Confirmation Byte
0x49		Font ASCII Start Value
	0x49	Echo Font ASCII Start Value
0x01		Confirmation Byte
...	...	...
0x60		Last Font File Byte
	0x60	Echo Last Font File Byte
0x01		Confirm Upload Finished

Table 48: Upload Protocol

The last part of uploading a font file is to upload the file data. After transmitting each byte of the file the module will echo the byte and wait for a confirmation byte of 0x01 until the file has completed uploading. Below is an example of uploading the font file which we created in *Section 5.1.2 on page 22*.

At times that the display or the host sees anything else other than 0x01 for confirmation (usually a 0x08) the upload is aborted.

---

#### NOTES

- The GLT24064 has watch dog timer, set to 2.1 seconds in between transmissions, in order prevent the display module from staying in a waiting state.
  - Once the timeout has been reached the timer will reset the display and issue a 0xFE 0xD4 response to the host to signal that this has happened.
-

## 11.1.2 XModem Upload Protocol

In addition to its original simple upload format, Matrix Orbital has added an XModem based protocol. This facilitates much faster download speeds by increasing the packet size from 1 byte to 128 bytes greatly increasing throughput. A two byte CRC check is performed at the end of each packet in place of the byte echo system seen in the original protocol. However, the overall protocol remains much the same as the original, but much faster.

To begin the upload, a series of command bytes are sent, much like the original protocol. However, no distinction is made between bitmap and font as the XModem protocol is used to upload bin or ebin files that contain all the bitmaps and fonts required for the unit. Once the command bytes are sent, the size of the file is sent in two bytes, least significant byte first. Then two additional bytes are sent of the value zero.

At this point the display will respond with an ACK if the file fits, or a NAK otherwise. Please note that these values are different than those of the original protocol as seen in the table below. If a NAK is seen at any point by the host, the upload is to be aborted in the same fashion as the regular protocol.

If the file will fit, the start of header byte will be sent by the host, followed by a block count representing the number of 128 byte blocks remaining to upload in regular and inverted forms. The display will then check to make sure the block count value matches its own before ACKing. The host can then send a 128 byte block of data followed by that blocks high and low CRC16 bytes. The display then performs a CRC check on the data received and ACKs if it matches that which was sent. Transfer continues with a block count and continues in this way until the end of file is reached.

Once the end of the upload file is reached, the host should transmit a single end of transmission byte. If the end of file is expected, the display will ACK one last time. This EOT byte along with the other special characters mentioned above is listed in the table below.

Character	Byte	Description
ACK	0x06	Acknowledged; successful data transmission
NAK	0x21	Not Acknowledged; transmission unsuccessful, abort upload
SOH	0x01	Start of Header; begin upload process
EOT	0x04	End of Transmission; file upload complete

Below is an example of uploading a bin or ebin file using the XModem protocol.

## 11.2 Wipe Filesystem

Syntax	Hexadecimal	0xFE 0x21 0x59 0x21
	Decimal	254 33 89 33
	ASCII	254 “!” “Y” “!”

Description This command completely erases the display's non-volatile memory. It removes all fonts, font metrics, bitmaps, and settings (current font, cursor position, communication speed, etc.). It is an "odd" command in that it is three bytes in length in order to prevent accidental execution.

---

**NOTE** After deleting the file system it is important to cycle power to your display to ensure the removal process is completed.

---

Remembered Yes

### 11.3 Deleting a File

Syntax Hexadecimal 0xFE 0xAD [type] [refID]  
Decimal 254 173 [type] [refID]

Parameters	Parameter	Length	Description
	type	1	Type of file (0:Font, 1:Bitmap)
	refID	1	Reference ID of the file to delete.

Description This command erases a single file at a time within the GLT24064 memory when given two parameters: [type] and [refID]. The file type and reference number are defined when the file is saved to the GLT24064.

- [type] = 1: Bitmap
- [type] = 0: Font

---

**NOTE** After deleting a file it is important to cycle power to your display to ensure file system integrity.

---

Remembered Yes

### 11.4 Get Filesystem Space

Syntax Hexadecimal 0xFE 0xAF  
Decimal 254 175

Description This command will return 4 bytes, LSB to MSB for how many bytes are remaining in the 16 KB on board memory.

Remembered No

Host	Display	Comments
0xFE		Command Prefix
0xDB		XModem Upload Command
0x85		Command byte 1
0x06		Command byte 2
0x30		Command byte 3
0x00		Size Low Byte
0x40		Size High Byte
0x00		0
0x00		0
	0x06	ACK (NAK if file is too big)
0x01		Start of Header
0x80		Block Count
0x7F		255 - Block Count
	0x06	ACK (NAK if counts don't match)
<128 bytes>		Data Block
0x1E		CRC High Byte
0x47		CRC Low Byte
	0x06	ACK (NAK if CRCs don't match)
0x7F		Block Count
0x80		255 - Block Count
	0x06	ACK (NAK if counts don't match)
<128 bytes>		Data Block
0x5A		CRC High Byte
0x0D		CRC Low Byte
	0x06	ACK (NAK if CRCs don't match)
...	...	...
0x04		End of Transmission
	0x06	ACK (NAK if EOT is not expected)

Table 49: XModem Upload Protocol

## 11.5 Get Filesystem Directory

Syntax	Hexadecimal 0xFE 0xB3 Decimal 254 179
Description	This command will return a directory of the contents of the file system. The first byte returned will be a hex value representing the number of entries in the filesystem, followed by four bytes for each entry. See the following tables:

Filesystem Header	
Bytes	Description
1	Hex value representing the number of entries in the filesystem
File Entry	
Bytes	Description
1	Flag: Hex value of 0x00 indicates that this file entry has not been used.
1	FileID/Type: 1st bit is the file type (0: Font, 1: Bitmap). Next 7 bits are the file ID.
1	File Size: LSB
1	File Size: MSB

Remembered No

## 11.6 Filesystem Upload

Syntax	Hexadecimal 0xFE 0xB0 [Size] [Data] Decimal 254 176 [Size] [Data]									
Parameters	<table border="1"> <thead> <tr> <th>Parameter</th> <th>Length</th> <th>Description</th> </tr> </thead> <tbody> <tr> <td>Size</td> <td>4</td> <td>LSB to MSB filesystem image data</td> </tr> <tr> <td>Data</td> <td>var</td> <td>Actual data to upload</td> </tr> </tbody> </table>	Parameter	Length	Description	Size	4	LSB to MSB filesystem image data	Data	var	Actual data to upload
Parameter	Length	Description								
Size	4	LSB to MSB filesystem image data								
Data	var	Actual data to upload								
Description	This command will upload a filesystem image, LSB to MSB to the display (16KB). The size used is almost always the entire 16kB, meaning the values 0x00 0x40 0x00 0x00 must be issued. After which the filesystem data can be uploaded LSB to MSB in the same manner as a font or bitmap file.									

Remembered Always

## 11.7 Downloading a File

Syntax	Hexadecimal	0xFE 0xB2 [Type] [refID]	
	Decimal	254 178 [Type] [refID]	
Parameters	Parameter	Length	Description
	Type	1	File type (0:Font File, 1:Bitmap)
	refID	1	Reference ID number
Description	Download a specified file from the filesystem. The first 4 bytes will be the length of the file (LSB to MSB) followed by 2 bytes representing the width and height of the image then the data contained in the file.		
Remembered	No		

## 11.8 Moving a File

Syntax	Hexadecimal	0xFE 0xB4 [oldT] [oldID] [newT] [newID]		
	Decimal	254 180 [oldT] [oldID] [newT] [newID]		
Parameters	Parameter	Length	Description	
	oldT	1	Old file type	
	oldID	1	Old file ID	
	newT	1	New file type	
	newID	1	New file ID	
Description	This command can be used to move a file to a new file ID, or correct the type of a file that was uploaded incorrectly. The command first checks to see if there is a file identified by [oldT] and [oldID]. If it does exist, and there is no file already with the desired type and ID, the ID and type of the old file will be changed to [newT] and [newID] respectively.			
Remembered	Always			

## 12 Data Security

### 12.1 Introduction

Ensuring that your GLT24064 display's exactly what you want it to can be the difference between a projects success and failure. This is why we incorporate features such as Data Lock into the GLT24064. With this new feature you now are in control over of how and when settings will be changed so there is no need to worry about the module acting exactly like you expected it to because all the settings may be locked and remembered for the next power up.

## 12.2 Set Remember

Syntax	Hexadecimal	0xFE 0x93 [switch]	
	Decimal	254 147 [switch]	
Parameters	Parameter	Length	Description
	switch	1	0: Do not remember, 1: Remember
Description	This command allows you to switch the remember function on and off. To use the remember function, set remember to on, then set all of the settings that you wish to save, settings that are listed as 'Remember: Yes' support being saved into the non-volatile memory. After you have set all of the commands that you wish to save, you may then cycle the power and check the display settings to ensure that all the settings have been saved. If you wish to use remember again after cycling the power, you must set it to on again.		

---

### NOTES

- Writing to non-volatile memory is time consuming and slows down the operation of the display.
- Non-volatile memory has a 'write limit' and may only be changed approximately 100,000 times.

---

Remembered	No
Default	Do not remember

## 12.3 Data Lock

Syntax	Hexadecimal	0xFE 0xCA 0xF5 0xA0 [level]	
	Decimal	254 202 245 160 [level]	
Parameters	Parameter	Length	Description
	level	1	Sets the data lock level

## Description

Paranoia allows you to lock the module from displaying information, as well as enables the protection of the filesystem and module settings.

Each bit corresponds corresponds to a different lock level, while sending a zero will unlock your display as the following tables explains:

Bit	Data Lock Level	Description
0-2	Reserved	Should be left 0
3	Communication Speed Lock	When this bit is set (1) the Baud Rate and I <sup>2</sup> C Slave address are locked
4	Setting Lock	When this bit is set (1) the display settings such as backlight, contrast and GPO settings are locked. (Internal EEPROM)
5	Filesystem Lock	When this bit is set (1) the external EEPROM is locked, this has the same effect as the File System Jumper
6	Command Lock	When this bit is set (1) all commands but commands 202/203 are locked. (cmd lock)
7	Display Lock	When this bit is set (1) the module is locked from displaying any new information. (text lock)

---

## NOTES

- Sending a new data lock level will override the previous data lock level.
- Data lock levels may be combined.

Remembered  
Default  
Examples

Always  
0

Hex	Dec	Binary	Description
0x00	0	0	Unlock
0x50	80	01010000	Setting and Command Lock



## 12.4 Set and Save Data Lock

Syntax	Hexadecimal	0xFE 0xCB 0xF5 0xA0 [level]	
	Decimal	254 203 245 160 [level]	
Parameters	Parameter	Length	Description
	level	1	Sets the data lock level
Description	This command will set and save the data lock level. See the Data Lock section for more information.		
Remembered	Always		
Default	0		

## 12.5 Dump the Filesystem

Syntax	Hexadecimal	0xFE 0x30	
	Decimal	254 48	
	ASCII	254 "0"	
Description	This will allow you to dump the filesystem for debugging purposes. It will return a 4 byte value LSB to MSB followed by 16384 bytes making up the file system.		
Remembered	No		

## 12.6 Write Customer Data

Syntax	Hexadecimal	0xFE 0x34 [data]	
	Decimal	254 52 [data]	
	ASCII	254 "4" [data]	
Parameters	Parameter	Length	Description
	data	16	Writes the customer data
Description	Writes the customer Data. 16 Bytes of data can be saved in non-volatile memory.		
Remembered	No		

## 12.7 Read Customer Data

Syntax	Hexadecimal	0xFE 0x35
	Decimal	254 53
	ASCII	254 "5"

Description Reads whatever was written by Write Customer Data.  
Remembered No

## 13 Miscellaneous

### 13.1 Introduction

This chapter covers the 'Report Version Number' and 'Read Module Type' commands. These commands can be particularly useful to find out more information about the display module before contacting technical support.

### 13.2 Read Version Number

Syntax Hexadecimal 0xFE 0x36  
Decimal 254 54  
ASCII 254 "6"  
Description This command will return a byte representing the version of the module, see the following table as an example:

Hex Value	Version Number
0x19	Version 1.9
0x57	Version 5.7

Remembered No

### 13.3 Read Module Type

Syntax Hexadecimal 0xFE 0x37  
Decimal 254 55  
ASCII 254 "7"

Description

This command will return a hex value corresponding to the the model number of the module see the following table:

Hex	Product ID	Hex	Product ID
1	LCD0821	2	LCD2021
5	LCD2041	6	LCD4021
7	LCD4041	8	LK202-25
9	LK204-25	A	LK404-55
B	VFD2021	C	VFD2041
D	VFD4021	E	VK202-25
F	VK204-25	10	GLC12232
13	GLC24064	14	Unused
15	GLK24064-25	16	Unused
21	Unused	22	GLK12232-25
23	Unused	24	GLK12232-25-SM
25	GLK24064-16-1U-USB	26	GLK24064-16-1U
27	GLK19264-7T-1U-USB	28	GLK12232-16
29	GLK12232-16-SM	2A	GLK19264-7T-1U
2B	LK204-7T-1U	2C	LK204-7T-1U-USB
31	LK404-AT	32	MOS-AV-162A
33	LK402-12	34	LK162-12
35	LK204-25PC	36	LK202-24-USB
37	VK202-24-USB	38	LK204-24-USB
39	VK204-24-USB	3A	PK162-12
3B	VK162-12	3C	MOS-AP-162A
3D	PK202-25	3E	MOS-AL-162A
3F	MOS-AL-202A	40	MOS-AV-202A
41	MOS-AP-202A	42	PK202-24-USB
43	MOS-AL-082	44	MOS-AL-204
45	MOS-AV-204	46	MOS-AL-402
47	MOS-AV-402	48	LK082-12
49	VK402-12	4A	VK404-55
4B	LK402-25	4C	VK402-25
4D	PK204-25	4E	Unused
4F	MOS	50	MOI
51	XBoard-S	52	XBoard-I
53	MOU	54	XBoard-U
55	LK202-25-USB	56	VK202-25-USB
57	LK204-25-USB	58	VK204-25-USB
5B	LK162-12-TC	5C	Unused
71	Unused	72	GLK240128-25
73	LK404-25	74	VK404-25
77	Unused	78	GLT320240
79	GLT480282	7A	GLT240128

Remembered

No

## 14 Command Summary

### 14.1 Communications

Description	Syntax	Page
Turn Flow Control On	Hexadecimal	0xFE 0x3A [full] [empty]
	Decimal	254 58 [full] [empty]
	ASCII	254 “;” [full] [empty]
Turn Flow Control Off	Hexadecimal	0xFE 0x3B
	Decimal	254 59
	ASCII	254 “;”
Changing the I <sup>2</sup> C Slave Address	Hexadecimal	0xFE 0x33 [adr]
	Decimal	254 51 [adr]
	ASCII	254 “3” [adr]
Changing the Baud Rate	Hexadecimal	0xFE 0x39 [speed]
	Decimal	254 57 [speed]
	ASCII	254 “9” [speed]
Setting a Non-Standard Baud Rate	Hexadecimal	0xFE 0xA4 [speed]
	Decimal	254 164 [speed]

### 14.2 Fonts

Description	Syntax	Page
Uploading a Font File	Hexadecimal	0xFE 0x24 [refID] [size] [data]
	Decimal	254 36 [refID] [size] [data]
	ASCII	254 “\$” [refID] [size] [data]
Setting the Current Font	Hexadecimal	0xFE 0x31 [refID]
	Decimal	254 49 [refID]
	ASCII	254 “1” [refID]
Font Metrics	Hexadecimal	0xFE 0x32 [lm] [tm] [csp] [lsp] [srow]
	Decimal	254 50 [lm] [tm] [csp] [lsp] [srow]
	ASCII	254 “2” [lm] [tm] [csp] [lsp] [srow]
Set Box Space Mode	Hexadecimal	0xFE 0xAC [value]
	Decimal	254 172 [value]

### 14.3 Text

Description	Syntax	Page
Move Cursor Home	Hexadecimal	0xFE 0x48
	Decimal	254 72
	ASCII	254 “H”

Description	Syntax	Page
Setting the Cursor Position	Hexadecimal	0xFE 0x47 [col] [row]
	Decimal	254 71 [col] [row]
	ASCII	254 "G" [col] [row]
Setting the Cursor Coordinate	Hexadecimal	0xFE 0x79 [x] [y]
	Decimal	254 121 [x] [y]
	ASCII	254 "y" [x] [y]
Auto Scroll On	Hexadecimal	0xFE 0x51
	Decimal	254 81
	ASCII	254 "Q"
Auto Scroll Off	Hexadecimal	0xFE 0x52
	Decimal	254 82
	ASCII	254 "R"

## 14.4 Bitmaps

Description	Syntax	Page
Uploading a Bitmap File	Hexadecimal	0xFE 0x5E [refID] [size] [data]
	Decimal	254 94 [refID] [size] [data]
	ASCII	254 "^" [refID] [size] [data]
Drawing a Bitmap from Memory	Hexadecimal	0xFE 0x62 [refID] [X] [Y]
	Decimal	254 98 [refID] [X] [Y]
	ASCII	254 "b" [refID] [X] [Y]
Drawing a Bitmap Directly	Hexadecimal	0xFE 0x64 [X] [Y] [W] [H] [D]
	Decimal	254 100 [X] [Y] [W] [H] [D]
	ASCII	254 "d" [X] [Y] [W] [H] [D]

## 14.5 Bar Graphs and Drawing

Description	Syntax	Page
Set Drawing Color	Hexadecimal	0xFE 0x63 [color]
	Decimal	254 99 [color]
	ASCII	254 "c" [color]
Draw Pixel	Hexadecimal	0xFE 0x70 [x] [y]
	Decimal	254 112 [x] [y]
	ASCII	254 "p" [x] [y]
Drawing a Line	Hexadecimal	0xFE 0x6C [x1] [y1] [x2] [y2]
	Decimal	254 108 [x1] [y1] [x2] [y2]
	ASCII	254 "l" [x1] [y1] [x2] [y2]
Continue a Line	Hexadecimal	0xFE 0x65 [x] [y]
	Decimal	254 101 [x] [y]
	ASCII	254 "e" [x] [y]

Description	Syntax	Page
Draw a Rectangle	Hexadecimal	0xFE 0x72 [color] [x1] [y1] [x2] [y2]
	Decimal	254 114 [color] [x1] [y1] [x2] [y2]
	ASCII	254 “r” [color] [x1] [y1] [x2] [y2]
Drawing a Solid Rectangle	Hexadecimal	0xFE 0x78 [color] [x1] [y1] [x2] [y2]
	Decimal	254 120 [color] [x1] [y1] [x2] [y2]
	ASCII	254 “x” [color] [x1] [y1] [x2] [y2]
Initializing a Bar Graph	Hexadecimal	0xFE 0x67 [refID] [type] [x1] [y1] [x2] [y2]
	Decimal	254 103 [refID] [type] [x1] [y1] [x2] [y2]
	ASCII	254 “g” [refID] [type] [x1] [y1] [x2] [y2]
Drawing a Bar Graph	Hexadecimal	0xFE 0x69 [ref] [value]
	Decimal	254 105 [ref] [value]
	ASCII	254 “i” [ref] [value]
Initializing a Strip Chart	Hexadecimal	0xFE 0x6A [refID] [x1] [y1] [x2] [y2]
	Decimal	254 106 [refID] [x1] [y1] [x2] [y2]
	ASCII	254 “j” [refID] [x1] [y1] [x2] [y2]
Shifting a Strip Chart	Hexadecimal	0xFE 0x6B [ref]
	Decimal	254 107 [ref]
	ASCII	254 “k” [ref]

## 14.6 Touchpad

Description	Syntax	Page
Set Touch Region	Hexadecimal	0xFE 0x84 [num] [x] [y] [w] [h] [keyDown] [keyUp]
	Decimal	254 132 [num] [x] [y] [w] [h] [keyDown] [keyUp]
Delete Touch Region	Hexadecimal	0xFE 0x85 [num]
	Decimal	254 133 [num]
Delete All Touch Regions	Hexadecimal	0xFE 0x86
	Decimal	254 134
Set Touch Mode	Hexadecimal	0xFE 0x87 [mode]
	Decimal	254 135 [mode]
Set Region Reporting Mode	Hexadecimal	0xFE 0x88 [mode]
	Decimal	254 136 [mode]
Set Dragging Threshold	Hexadecimal	0xFE 0x89 [threshold]
	Decimal	254 137 [threshold]
Set Pressure Threshold	Hexadecimal	0xFE 0x8A [threshold]
	Decimal	254 138 [threshold]
Run Touchpad Calibration	Hexadecimal	0xFE 0x8B
	Decimal	254 139

## 14.7 Display Functions

Description	Syntax	Page	
Clear Screen	Hexadecimal	0xFE 0x58	40
	Decimal	254 88	
	ASCII	254 "X"	
Display On	Hexadecimal	0xFE 0x42 [min]	40
	Decimal	254 66 [min]	
	ASCII	254 "B" [min]	
Display Off	Hexadecimal	0xFE 0x46	41
	Decimal	254 70	
	ASCII	254 "F"	
Set Brightness	Hexadecimal	0xFE 0x99 [brightness]	41
	Decimal	254 153 [brightness]	
Set and Save Brightness	Hexadecimal	0xFE 0x98 [brightness]	41
	Decimal	254 152 [brightness]	
Set Contrast	Hexadecimal	0xFE 0x50 [contrast]	42
	Decimal	254 80 [contrast]	
	ASCII	254 "P" [contrast]	
Set and Save Contrast	Hexadecimal	0xFE 0x91 [contrast]	42
	Decimal	254 145 [contrast]	

## 14.8 Filesystem

Description	Syntax	Page	
Wipe Filesystem	Hexadecimal	0xFE 0x21 0x59 0x21	45
	Decimal	254 33 89 33	
	ASCII	254 "!" "Y" "!"	
Deleting a File	Hexadecimal	0xFE 0xAD [type] [refID]	46
	Decimal	254 173 [type] [refID]	
Get Filesystem Space	Hexadecimal	0xFE 0xAF	46
	Decimal	254 175	
Get Filesystem Directory	Hexadecimal	0xFE 0xB3	48
	Decimal	254 179	
Filesystem Upload	Hexadecimal	0xFE 0xB0 [Size] [Data]	48
	Decimal	254 176 [Size] [Data]	
Downloading a File	Hexadecimal	0xFE 0xB2 [Type] [refID]	48
	Decimal	254 178 [Type] [refID]	
Moving a File	Hexadecimal	0xFE 0xB4 [oldT] [oldID] [newT] [newID]	49
	Decimal	254 180 [oldT] [oldID] [newT] [newID]	

## 14.9 Data Security

Description	Syntax	Page	
Set Remember	Hexadecimal	0xFE 0x93 [switch]	50
	Decimal	254 147 [switch]	

Description	Syntax	Page
Data Lock	Hexadecimal 0xFE 0xCA 0xF5 0xA0 [level]	50
	Decimal 254 202 245 160 [level]	
Set and Save Data Lock	Hexadecimal 0xFE 0xCB 0xF5 0xA0 [level]	52
	Decimal 254 203 245 160 [level]	
Dump the Filesystem	Hexadecimal 0xFE 0x30	52
	Decimal 254 48	
	ASCII 254 "0"	
Write Customer Data	Hexadecimal 0xFE 0x34 [data]	52
	Decimal 254 52 [data]	
	ASCII 254 "4" [data]	
Read Customer Data	Hexadecimal 0xFE 0x35	52
	Decimal 254 53	
	ASCII 254 "5"	

## 14.10 Miscellaneous

Description	Syntax	Page
Read Version Number	Hexadecimal 0xFE 0x36	53
	Decimal 254 54	
	ASCII 254 "6"	
Read Module Type	Hexadecimal 0xFE 0x37	53
	Decimal 254 55	
	ASCII 254 "7"	

## 14.11 Command By Number

Command Hex	Description		Page
	Dec	ASCII	
0x21	33	"!"	Wipe Filesystem 45
0x24	36	"\$"	Uploading a Font File 24
0x30	48	"0"	Dump the Filesystem 52
0x31	49	"1"	Setting the Current Font 24
0x32	50	"2"	Font Metrics 25
0x33	51	"3"	Changing the I <sup>2</sup> C Slave Address 19
0x34	52	"4"	Write Customer Data 52
0x35	53	"5"	Read Customer Data 52
0x36	54	"6"	Read Version Number 53
0x37	55	"7"	Read Module Type 53
0x39	57	"9"	Changing the Baud Rate 20
0x3A	58	":"	Turn Flow Control On 18
0x3B	59	","	Turn Flow Control Off 19
0x42	66	"B"	Display On 40



Command	Description	Page		
Hex	Dec	ASCII		
0x46	70	“F”	Display Off	41
0x47	71	“G”	Setting the Cursor Position	27
0x48	72	“H”	Move Cursor Home	26
0x50	80	“P”	Set Contrast	42
0x51	81	“Q”	Auto Scroll On	27
0x52	82	“R”	Auto Scroll Off	28
0x58	88	“X”	Clear Screen	40
0x5E	94	“^”	Uploading a Bitmap File	28
0x62	98	“b”	Drawing a Bitmap from Memory	29
0x63	99	“c”	Set Drawing Color	30
0x64	100	“d”	Drawing a Bitmap Directly	30
0x65	101	“e”	Continue a Line	32
0x67	103	“g”	Initializing a Bar Graph	33
0x69	105	“i”	Drawing a Bar Graph	34
0x6A	106	“j”	Initializing a Strip Chart	34
0x6B	107	“k”	Shifting a Strip Chart	35
0x6C	108	“l”	Drawing a Line	31
0x70	112	“p”	Draw Pixel	31
0x72	114	“r”	Draw a Rectangle	32
0x78	120	“x”	Drawing a Solid Rectangle	32
0x79	121	“y”	Setting the Cursor Coordinate	27
0x84	132		Set Touch Region	37
0x85	133		Delete Touch Region	37
0x86	134		Delete All Touch Regions	37
0x87	135		Set Touch Mode	38
0x88	136		Set Region Reporting Mode	38
0x89	137		Set Dragging Threshold	39
0x8A	138		Set Pressure Threshold	39
0x8B	139		Run Touchpad Calibration	39
0x91	145		Set and Save Contrast	42
0x93	147		Set Remember	50
0x98	152		Set and Save Brightness	41
0x99	153		Set Brightness	41
0xA4	164		Setting a Non-Standard Baud Rate	21
0xAC	172		Set Box Space Mode	26
0xAD	173		Deleting a File	46
0xAF	175		Get Filesystem Space	46
0xB0	176		Filesystem Upload	48
0xB2	178		Downloading a File	48
0xB3	179		Get Filesystem Directory	48
0xB4	180		Moving a File	49

# 15 Appendix

## 15.1 Optical Characteristics

Table 76: Optical Characteristics

<b>Pixel Layout (WxH)</b>	240 x 128 pixels
<b>Display Area</b>	107.95 x 57.55mm
<b>Dot Size</b>	0.40 x 0.40mm
<b>Dot Pitch</b>	0.45 x 0.45mm
<b>Viewing Angle (Vertical)</b>	+35°/- 20° from Normal
<b>Viewing Angle (Horizontal)</b>	+30°/- 30° from Normal
<b>LED Backlight Life(GW&amp;WB)</b>	10,000 hours typical
<b>LED Backlight Life(YG)</b>	50,000 hours typical
<b>Backlight</b>	white or yellow-green STN LED

---

**NOTE** To prolong life, it is recommended that the backlight be turned off when the display is not in use.

---

## 15.2 Specifications

### 15.2.1 Environmental

Table 77: Environmental Specifications

<b>Operating Temperature</b>	0°C to +50°C
<b>Storage Temperature</b>	-20°C to +70°C
<b>Operating Relative Humidity</b>	60% max non-condensing
<b>Vibration (Operating)</b>	4.9 m/s <sup>2</sup> XYZ directions
<b>Vibration (Non-Operating)</b>	19.6 m/s <sup>2</sup> XYZ directions
<b>Shock (Operating)</b>	29.4 m/s <sup>2</sup> XYZ directions
<b>Shock (Non-Operating)</b>	490 m/s <sup>2</sup> XYZ directions

Table 79: Touch Specifications

<b>Required Operation Force</b>	10-100g
<b>Tapping Durability</b>	1,000,000 at 250g with 2mm diameter stylus
<b>Sliding Durability</b>	100,000 at 250g with 2mm diameter stylus

## 15.2.2 Electrical

Table 78: Electrical Specifications

	<b>Standard</b>	<b>Wide Voltage (V)</b>	<b>Wide Voltage with ESPS (VPT)</b>
<b>Supply Voltage</b>	+5Vdc $\pm$ 0.25V	+9V to +15V	+9V to +35V
<b>Minimum Current</b>	80mA typical		
<b>Backlight ON (GW&amp;WB)</b>	add 90mA (170mA) typical		
<b>Backlight ON (YG)</b>	add 260mA (340mA) typical		



### WARNINGS

- Do not apply any power with reversed polarization.
  - Do not apply any voltage other than the specified voltage.
- 

## 15.2.3 Touch

## 15.3 Physical Layout

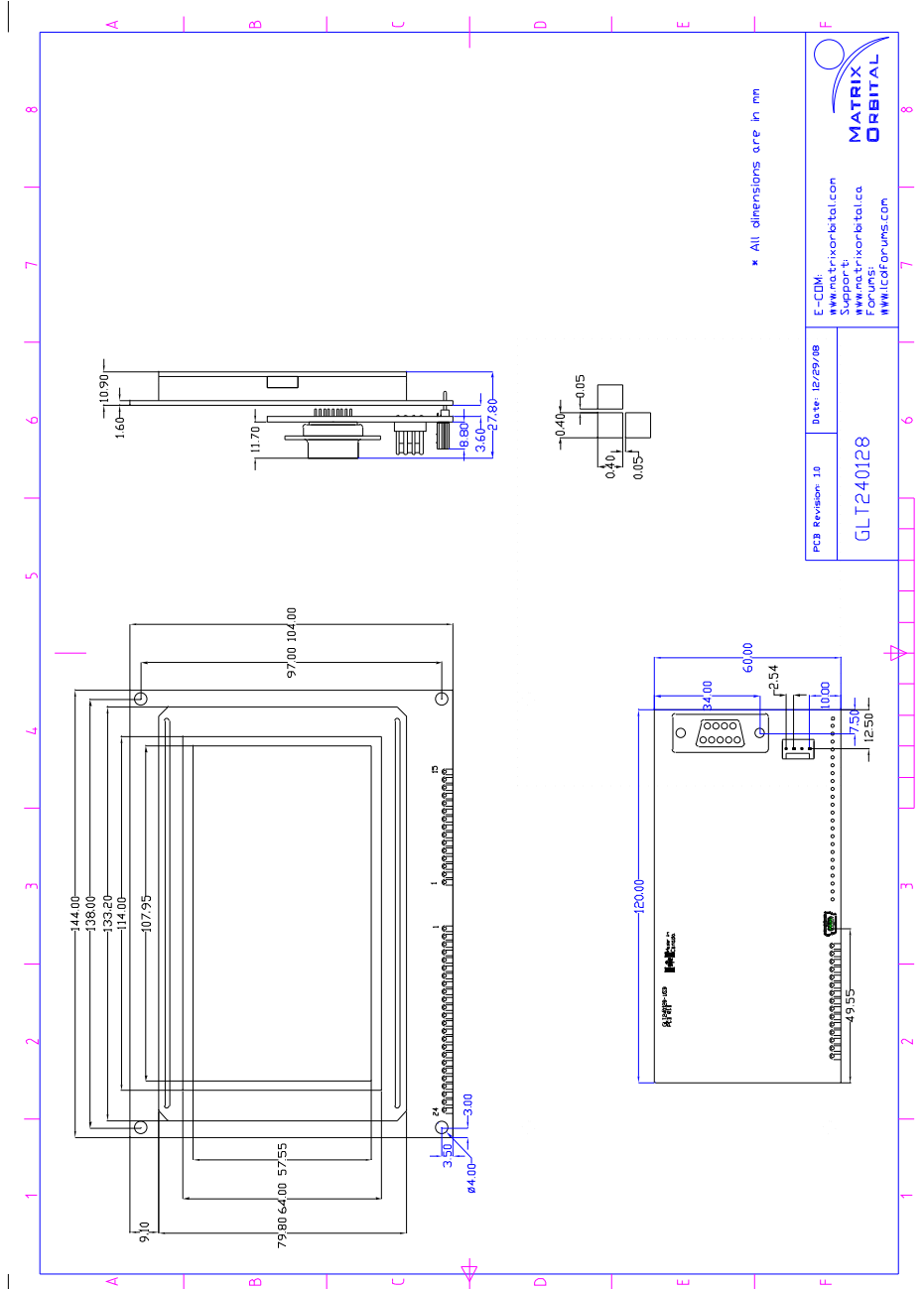

Figure 24: Physical Diagram

## 15.4 Ordering Information

<b>G</b>	<b>L</b>	<b>T</b>	<b>240</b>	<b>128</b>	<b>-USB</b>	<b>-VPT</b>	<b>-YG</b>
<b>1</b>	<b>2</b>	<b>3</b>	<b>4</b>	<b>5</b>	<b>6</b>	<b>7</b>	<b>8</b>

Table 80: Part Numbering Scheme

#	Description	Options
<b>1</b>	Screen Type	G: Graphic
<b>2</b>	Display Technology	L: Liquid Crystal Display
<b>3</b>	Input Interface	T: Touch Pad
<b>4</b>	Width	240: pixel width count
<b>5</b>	Height	128: pixel height count
<b>6</b>	Communication Interface	NP: Standard RS232/TTL/I <sup>2</sup> C interface -USB: USB only interface
<b>7</b>	Input Voltage	NP: Standard voltage (4.75-5.25V) -V: Wide voltage (9.00-15.00V) -VPT: Wide voltage with ESPS (9.00-35.00V)
<b>8</b>	Colour (Text/Background)	-YG: Grey/Yellow Green -GW: Grey/White -WB: White/Blue

Table 81: Part Options

## 15.5 Definitions

**V** Wide Voltage (+9 to +15Vdc)

**VPT** Wide Voltage with Efficient Switching Power Supply (+9 to +35Vdc)

**GW** White Backlight (Grey text on White Background)

**WB** White Backlight (White text on Blue Background)

**YG** Yellow Green Backlight with Grey text

**MSB** Most Significant Byte

**LSB** Least Significant Byte

## 15.6 Contacting Matrix Orbital

### Telephone

Sales: 1(403)229-2737

Support: 1(403)204-3750

### On The Web

Sales: <http://www.MatrixOrbital.com>  
Support: <http://www.MatrixOrbital.ca>  
Forums: <http://www.lcdforums.com>

## 15.7 Revision History

Table 82: Revision History

<b>Revision Number</b>	<b>Description</b>	<b>Author</b>
1.0	Initial Manual	Clark
1.1	Touch Specifications Added	Clark
1.2	Updated Backlight Life	Clark