

THIS DRAWING IS UNPUBLISHED.

RELEASED FOR PUBLICATION

12JUN2012

© COPYRIGHT 2012

BY Tyco Electronics Japan G.K.

ALL RIGHTS RESERVED.

LOC J DIST -

REVISIONS

P	LTR	DESCRIPTION	DATE	DWN	APVD
A		RELEASED	06DEC2013	T.S	N.Y
B		ADD ITEM	18NOV2014	T.S	N.Y

- 1. -1 : TYPE I , INSULATION DIAMETER 1.05-1.15mm
- 1- -1 : TYPE II, INSULATION DIAMETER 1.05-1.15mm
- 2 : TYPE I , INSULATION DIAMETER 0.93-1.05mm
- 1- -2 : TYPE II, INSULATION DIAMETER 0.93-1.05mm
- 3 : TYPE I , INSULATION DIAMETER 0.93-1.05mm IPC, 1.05-1.15mm IPC
- 4 : TYPE I , INSULATION DIAMETER 1.1-1.2mm

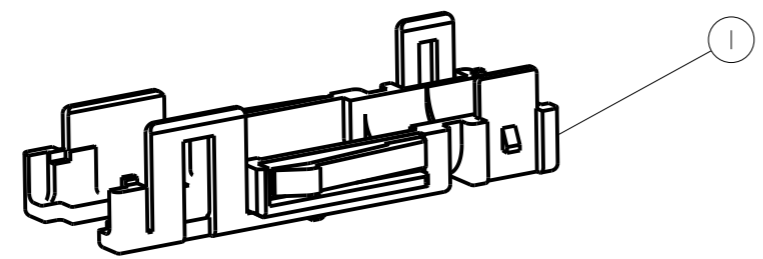
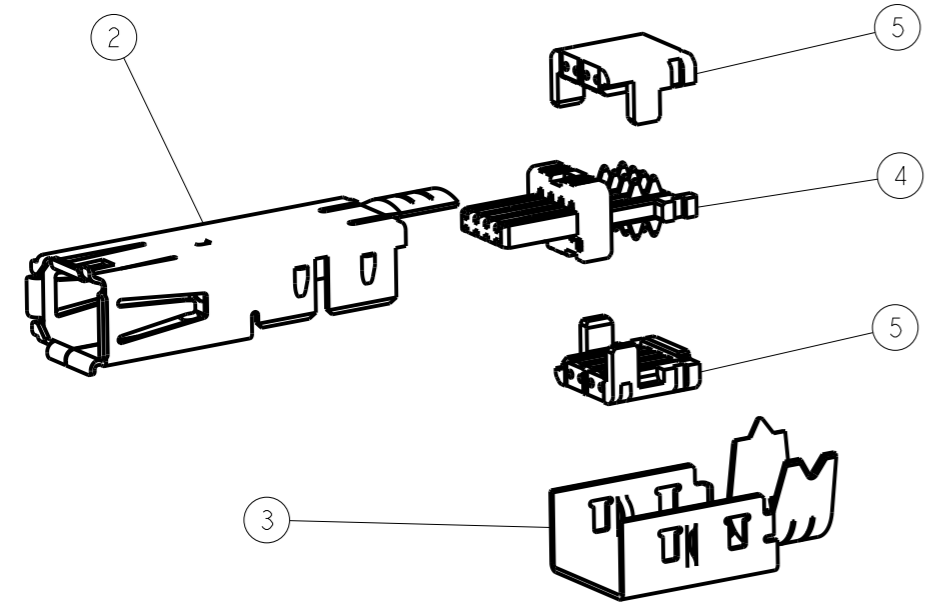
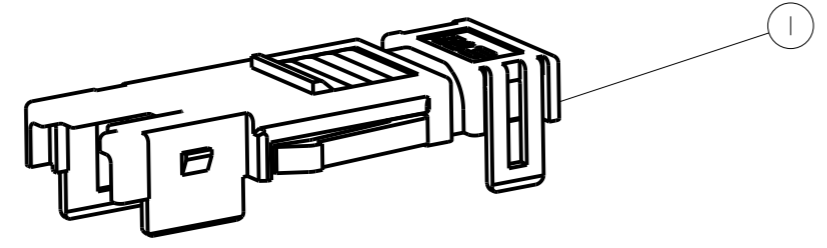
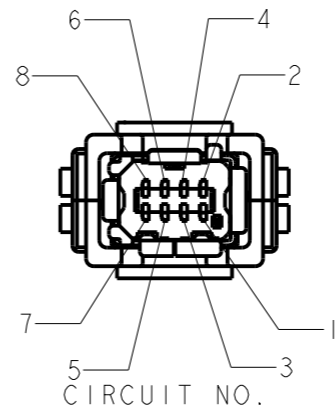
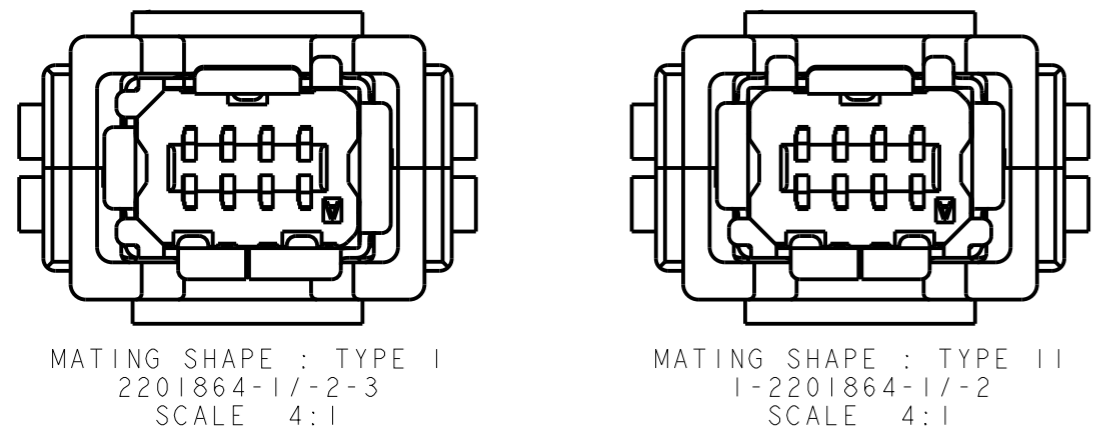
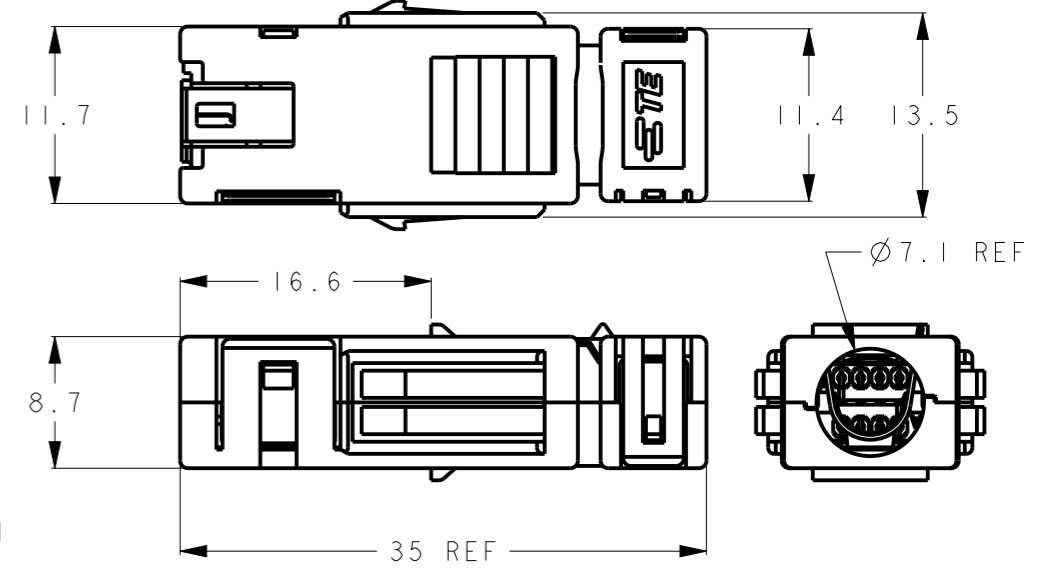
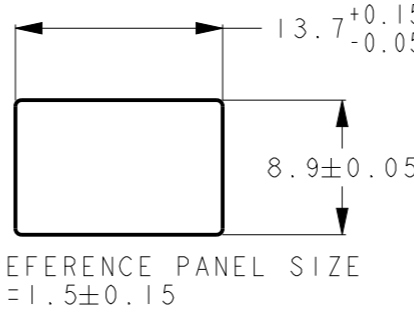

2	-	-	-	-	-				
-	1	2	2	-	-	THERMO PLASTIC	CABLE HSG Ø1.1-1.2 COLOR : GREEN		
-	1	-	-	2	2		CABLE HSG Ø0.93-1.05 COLOR : RED		5
							CABLE HSG Ø1.05-1.15 COLOR : BLUE		
1	1	1	1	1	1	HSG MATERIAL:THERMO PLASTIC		REC SUB ASSY	4
						CONTACT MATERIAL:COPPER ALLOY FINISH:NI PLATING ALL OVER CONTACT AREA Au PLATING TERMINATION AREA Au PLATING			
1	1	1	1	1	1	MATERIAL:COPPER ALLOY FINISH:NICKEL PLATING		BOTTOM SHELL	3
-	-	1	-	1	-	MATERIAL:COPPER ALLOY FINISH:NICKEL PLATING		REC TOP SHELL TYPE II	2
1	1	-	1	-	1	MATERIAL:COPPER ALLOY FINISH:NICKEL PLATING		REC TOP SHELL TYPE I	
2	2	2	2	2	2	THERMO PLASTIC		REC COVER HSG	1
-4	-3	1-	-2	-2	1-	-1	MATERIAL/FINISH	PART NAME	ITEM

THIS DRAWING IS A CONTROLLED DOCUMENT.

DWN 06DEC2013 T.SHIMOYASU  
CHK 06DEC2013 M.HARASAWA  
APVD 06DEC2013 N.YAMASAKI

TE Connectivity

INDUSTRIAL MINI I/O PIERCING REC CONNECTOR KIT

PRODUCT SPEC 108-78955  
APPLICATION SPEC 114-5506  
WEIGHT -

SIZE A3 CAGE CODE 00779 DRAWING NO C-2201864 RESTRICTED TO -

CUSTOMER DRAWING SCALE 2:1 SHEET 1 OF 1 REV B