

HOA2498

Reflective Sensor

FEATURES

- Choice of phototransistor or photodarlington output
- Focused for maximum response
- Wide operating temperature range (-55°C to +100°C)

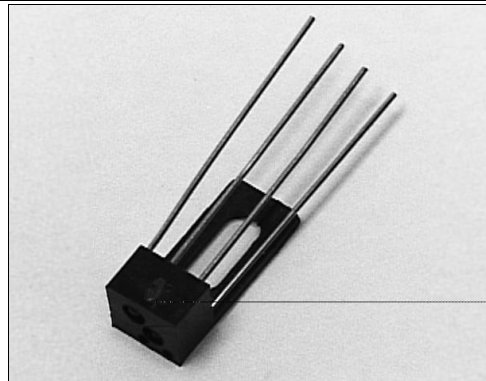

INFRA-64.TIF

DESCRIPTION

The HOA2498 series consists of an infrared emitting diode and an NPN silicon phototransistor (HOA2498-001, -002) or photodarlington (HOA2498-003), encased side-by-side on converging optical axes in a black thermoplastic housing. The detector responds to radiation from the IRED only when a reflective object passes within its field of view. The HOA2498 series employs metal can packaged components. For additional component information see SE1450, SD1440, and SD1410.

Housing material is polyester. Housings are soluble in chlorinated hydrocarbons and ketones. Recommended cleaning agents are methanol and isopropanol.

OUTLINE DIMENSIONS in inches (mm)

Tolerance 3 plc decimals ±0.010(0.25)
2 plc decimals ±0.020(0.51)

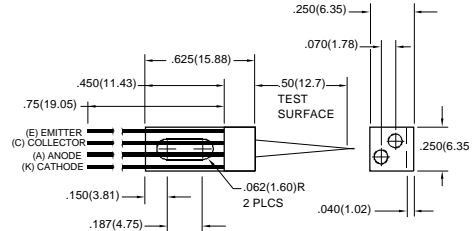

DIM_039.dwg

HOA2498

Reflective Sensor

ELECTRICAL CHARACTERISTICS (25°C unless otherwise noted)

PARAMETER	SYMBOL	MIN	TYP	MAX	UNITS	TEST CONDITIONS
IR EMITTER						
Forward Voltage	V_F			1.6	V	$I_F=20\text{ mA}$
Reverse Leakage Current	I_R			10	μA	$V_R=3\text{ V}$
DETECTOR						
Collector-Emitter Breakdown Voltage HOA2498-001, -002 HOA2498-003	$V_{(BR)CEO}$	30 15			V	$I_C=100\text{ }\mu\text{A}$
Emitter-Collector Breakdown Voltage	$V_{(BR)ECO}$	5.0			V	$I_E=100\text{ }\mu\text{A}$
Collector Dark Current HOA2498-001, -002 HOA2498-003	I_{CEO}			100 250	nA	$V_{CE}=10\text{ V}$ $I_F=0$
COUPLED CHARACTERISTICS						
On-State Collector Current HOA2498-001 HOA2498-002 HOA2498-003	$I_{C(ON)}$	0.04 0.16 2.0			mA	$V_{CE}=5\text{ V}$ $I_F=30\text{ mA}$ (1)
Collector-Emitter Saturation Voltage HOA2498-001 HOA2498-002 HOA2498-003	$V_{CE(SAT)}$			0.4 0.4 1.1	V	$I_F=30\text{ mA}$ (1) $I_C=5\text{ }\mu\text{A}$ $I_C=20\text{ }\mu\text{A}$ $I_C=250\text{ }\mu\text{A}$
Rise And Fall Time HOA2498-001, -002 HOA2498-003	t_r, t_f			15 75	μs	$V_{CC}=5\text{ V}, I_C=1\text{ mA}$ $R_L=1000\text{ }\Omega$ $R_L=100\text{ }\Omega$

Notes

1. Test surface is a front surface mirror (polished aluminum, 85% reflectance) located 0.50 in. (12.7 mm) from the front surface of the device.

ABSOLUTE MAXIMUM RATINGS

(25°C Free-Air Temperature unless otherwise noted)

Operating Temperature Range -55°C to 100°C

Storage Temperature Range -55°C to 125°C

Soldering Temperature (10 sec) 260°C

IR EMITTER

Power Dissipation 75 mW (1)

Reverse Voltage 3 V

Continuous Forward Current 50 mA

DETECTOR

Collector-Emitter Voltage 30 V

Emitter-Collector Voltage 5 V

Power Dissipation 75 mW (1) 75 mW (1)

Collector DC Current 30 mA 30 mA

TRANS. DARLINGTON

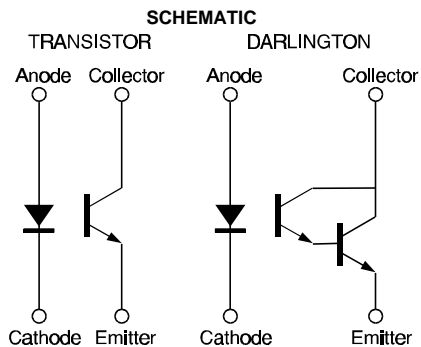

Honeywell reserves the right to make changes in order to improve design and supply the best products possible.

Honeywell

HOA2498

Reflective Sensor

Fig. 1 IRED Forward Bias Characteristics

gra_073.ds4

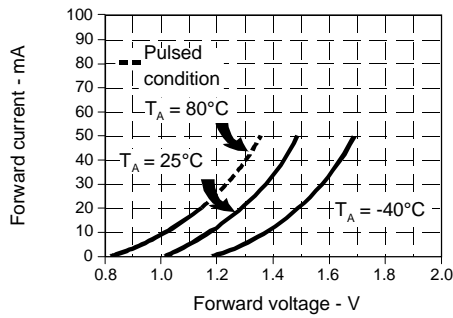

Fig. 2 Non-Saturated Switching Time vs Load Resistance

gra_079.ds4

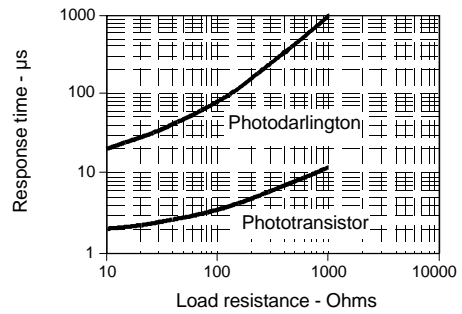

Fig. 3 Dark Current vs Temperature

gra_303.cdr

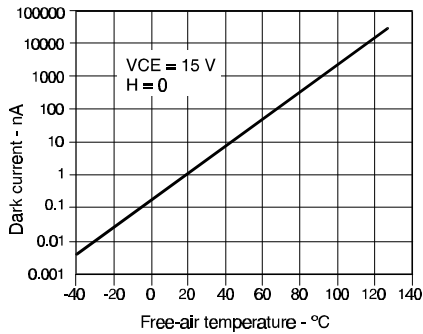

Fig. 4 Collector Current vs Ambient Temperature

gra_076.ds4



Fig. 5 Collector Current vs Distance to Reflective Surface

gra_084.ds4

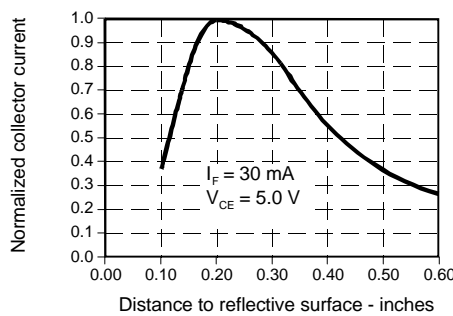
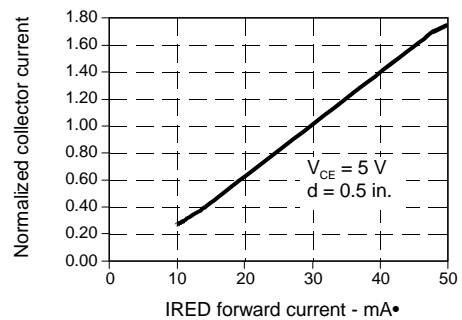

Fig. 6 Collector Current vs IRED Forward Current

gra_085.ds4



All Performance Curves Show Typical Values

HOA2498
Reflective Sensor



Honeywell reserves the right to make changes in order to improve design and supply the best products possible.

Honeywell