

PCV 4/ 2-G-7,62

Order No.: 1804687

The figure shows a 5-pos. version of the product

<http://eshop.phoenixcontact.de/phoenix/treeViewClick.do?UID=1804687>Header, Nominal current: 20 A, Nom. voltage: 400 V, Pitch: 7.62 mm,
Number of positions: 2, Color: green, Assembly: Soldering

Commercial data

EAN	4017918046125
Pack	50 pcs.
Customs tariff	85366990
Weight/Piece	0.004256 KG
Catalog page information	Page 371 (CC-2009)

Product notes

WEEE/RoHS-compliant since:
01/01/2003

<http://www.download.phoenixcontact.com>
Please note that the data given here has been taken from the online catalog. For comprehensive information and data, please refer to the user documentation. The General Terms and Conditions of Use apply to Internet downloads.

Technical data

Dimensions / positions

Pitch	7.62 mm
Dimension a	7.62 mm
Number of positions	2
Pin dimensions	1 x 0,8 mm
Hole diameter	1.3 mm

Technical data

Insulating material group	I
Rated surge voltage (III/3)	6 kV
Rated surge voltage (III/2)	6 kV
Rated surge voltage (II/2)	6 kV
Rated voltage (III/2)	630 V
Rated voltage (II/2)	630 V
Connection in acc. with standard	EN-VDE
Nominal current I_N	20 A
Nominal voltage U_N	400 V
Maximum load current	20 A
Insulating material	PA
Inflammability class acc. to UL 94	V0

Certificates / Approvals



Certification

BV, CSA, CUL, DNV, GL, GOST, LR, RS, UL

CSA

Nominal voltage U_N	300 V
Nominal current I_N	20 A

CUL

Nominal voltage U_N	300 V
Nominal current I_N	35 A

UL

Nominal voltage U_N	300 V
Nominal current I_N	35 A

Accessories

Item	Designation	Description
Assembly		
1827570	BF-PC 4	Mounting flange, is snapped onto the left and right of the headers, for screw connection with PC 4/...-STF-7.62

Marking		
1051993	B-STIFT	Marker pen, for manual labeling of unprinted Zack strips, smear-proof and waterproof, line thickness 0.5 mm
0804549	SK 7,62/3,8:FORTL.ZAHLEN	Marker card, printed horizontally, self-adhesive, 10-section marker strip, 12 identical decades marked 1-10, 11-20 etc. up to 91-99, sufficient for 120 terminal blocks
0805153	SK 7,62/3,8:SO	Marker card, special printing, self-adhesive, labeled acc. to customer requirements, 12 identical marker strips per card, max. 25-position labeling per strip, color: white
0803906	SK U/3,8 WH:UNBEDRUCKT	Unprinted marker cards, DIN A4 format, pitch as desired, self-adhesive, with 40 stamped marker strips, 185 mm strip length, can be labeled with the CMS system or manually with the M-PEN

Plug/Adapter		
1600027	CP-HCC 4	Coding profile, Color: red

Additional products

Item	Designation	Description
General		
1848892	PC 4 HV/ 2-ST-7,62	Plug component, Nominal current: 20 A, Nom. voltage: 800 V, Pitch: 7.62 mm, Number of positions: 2, Connection type: Screw connection, Color: green
1882379	PC 4 HV/ 2-STF-7,62	Plug component, Nominal current: 20 A, Nom. voltage: 800 V, Pitch: 7.62 mm, Number of positions: 2, Connection type: Screw connection, Color: green
1804904	PC 4/ 2-ST-7,62	Plug component, Nominal current: 20 A, Nom. voltage: 400 V, Pitch: 7.62 mm, Number of positions: 2, Connection type: Screw connection, Color: green
1828249	PC 4/ 2-STF-7,62	Plug component, Nominal current: 20 A, Nom. voltage: 400 V, Pitch: 7.62 mm, Number of positions: 2, Connection type: Screw connection, Color: green
1840191	PCC 4/ 2-ST-7,62	Plug component, Nominal current: 20 A, Nom. voltage: 400 V, Pitch: 7.62 mm, Number of positions: 2, Connection type: Crimp connection, Color: green

Diagrams/Drawings

Drilling plan/solder pad geometry

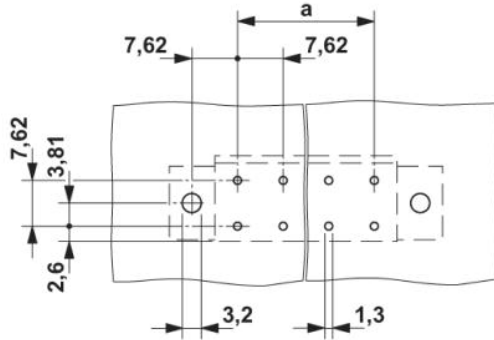

Dimensioned drawing

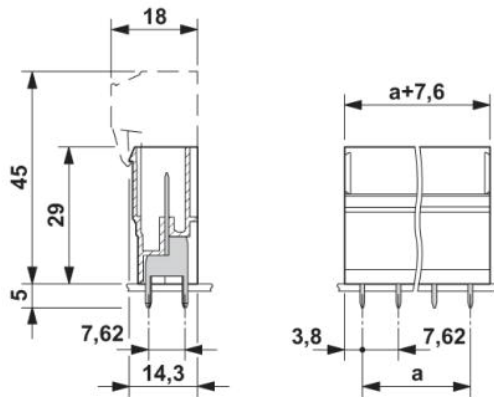

Address

PHOENIX CONTACT Inc., USA
586 Fulling Mill Road
Middletown, PA 17057, USA
Phone (800) 888-7388
Fax (717) 944-1625
<http://www.phoenixcon.com>



© 2010 Phoenix Contact
Technical modifications reserved;